

WIG-Brennerübersicht 2.0/V1





Copyright

Alle Texte, Bilder, Zeichnungen und sonstige in der Gesamtpreisliste veröffentlichten Informationen unterliegen – sofern nicht anders gekennzeichnet – dem Copyright der Alexander Binzel Schweisstechnik GmbH & Co. KG, Deutschland. Jeglicher Nachdruck, auch auszugsweise, ist nur mit ausdrücklicher, schriftlicher Genehmigung der Alexander Binzel Schweisstechnik GmbH & Co. KG, Deutschland gestattet.



Inhalt

■ Über uns, Ansprechpartner ...

■ Hersteller	luftgekühlt (GC)	flüssiggekühlt (LC)
■ „artec“	●	●
■ „bester“	●	●
■ „castolin“	●	●
■ „cebora“	●	●
■ „cloos“	●	●
■ „d + l“	●	●
■ „dalex“	●	●
■ „elektra-beckum“	●	●
■ „esab“	●	●
■ „ess“	●	●
■ „esseti“	●	●
■ „ewm“	●	●
■ „fronius“	●	●
■ „hermann“	●	●
■ „jäckle“	●	●
■ „kempfi“	●	●
■ „kjellberg“	●	●
■ „lincoln“	●	●
■ „lorch“	●	●
■ „l-tec“	●	●
■ „mahe“	●	●
■ „merkle“	●	●
■ „messer-lincoln“	●	●
■ „migatronic“	●	●
■ „migomat“	●	●
■ „nimak“	●	●
■ „oerlikon“	●	●
■ „pego“	●	●
■ „poro-bronze“	●	●
■ „rehm“	●	●
■ „röwac“	●	●
■ „röwac/röwig“	●	●
■ „rs-technologies“	●	●
■ „selco“	●	●
■ „stel“	●	●
■ „utp“	●	●
■ „weco“	●	●
■ „weltec“	●	●
■ „woltersdorf“	●	●
■ „MT-Brenner“	●	●
■ „V-Brenner“	●	●
■ Allgemeine Liefer- und Leistungsbedingungen		

Über uns ...



Spitzenposition im Weltmarkt.

Mit mehr als 850 Mitarbeitern, 30 Produktions- und Vertriebsgesellschaften sowie mit mehr als 20 Exklusivpartnern zählt die 1945 gegründete Alexander Binzel Schweisstechnik GmbH & Co. KG zu den Weltmarktführern in der Lichtbogen-Schweißtechnik und Brenner-technologie.

Neben einem qualitativ hochwertigen Produktprogramm bietet das Unternehmen komplexe individuelle Lösungen für die schweißtechnische Fertigung. Definierte Markenattribute und Garantien für die weltweiten Markterfolge sind: Entwicklungsstärke, Produktqualität, Engineering-Kompetenz und das internationale Vertriebs-, Beratungs- und Servicenetz.

In jedem Land stehen den Handelspartnern eigene Beratungs- und Betreuungsteams vor Ort zur Verfügung.



Qualität. Made by ABICOR BINZEL.

Unsere Produkte werden nach Binzel-Standards und internationalen Richtlinien gefertigt. Zertifiziert nach DIN EN ISO 9001.

Innovation. Heute und in Zukunft.

Wir entwickeln selbst in eigenen modernen Labors und in weltweiter Zusammenarbeit mit innovativen Köpfen aus Wissenschaft, Forschung und Industrie.



Global Player. Nähe zum Kunden – überall.

Weltweite Kundennähe ist eines der Erfolgsrezepte der Qualitätsmarke ABICOR BINZEL. Das in den letzten Jahren stark erweiterte Netz mit eigenen Gesellschaften und weiteren Länder-Vertretungen sichert der Marke die globale Beratungs-, Service- und Lieferkompetenz in den wichtigsten Industriestaaten sowie die weltweit lückenlose Versorgung der Kunden mit Originalteilen und Originalzubehör.

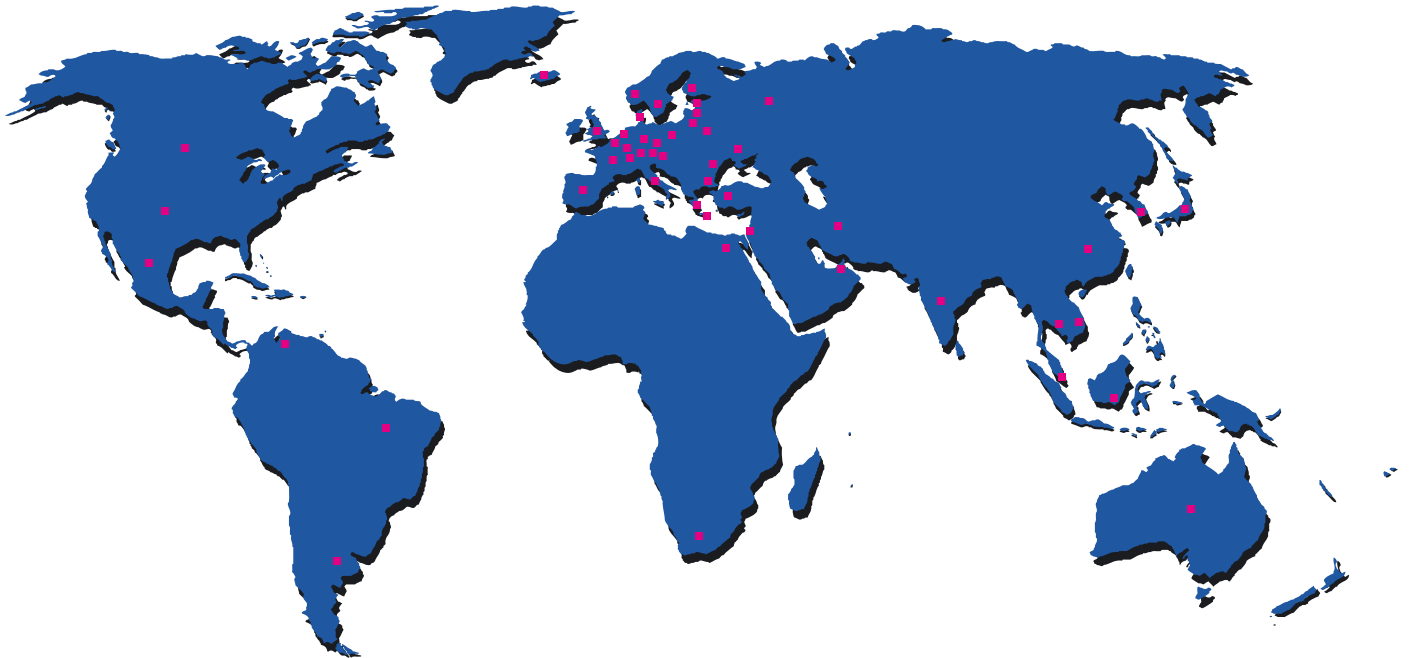

Original Markenqualität. International vertreten in:

 Ägypten	 Israel	 Spanien
 Argentinien	 Italien	 Südafrika
 Australien	 Japan	 Südkorea
 Belgien	 Kanada	 Thailand
 Brasilien	 Lettland	 Tschechische Republik
 Bulgarien	 Litauen	 Türkei
 China	 Luxemburg	 Ukraine
 Dänemark	 Mexiko	 Ungarn
 Deutschland	 Niederlande	 USA
 England	 Norwegen	 Venezuela
 Estland	 Österreich	 Ver. Arabische Emirate
 Finnland	 Polen	 Vietnam
 Frankreich	 Rumänien	 Weißrussland
 Griechenland	 Russland	 Zypern
 Indien	 Schweden	
 Indonesien	 Schweiz	
 Iran	 Singapur	
 Island	 Slowakische Republik	

Ihre Ansprechpartner im Außendienst ...



Wolfgang Wenzel
Tel.: 03 81/69 05 31
Handy: 01 71/76 62 026
E-Mail: wenzel@binzel-abcicor.com



Andreas Paul
Tel.: 0 53 41/22 39 293
Handy: 01 71/76 62 024
E-Mail: paul@binzel-abcicor.com



Heiner Makoschey
Tel.: 02 21/86 98 937
Handy: 01 71/76 62 023
E-Mail: makoschey@binzel-abcicor.com



Uwe Lein
Tel.: 03 71/80 00 821
Handy: 01 71/76 62 025
E-Mail: lein@binzel-abcicor.com



Uwe Meierhöfer
Tel.: 05 31/23 92 830
Handy: 01 71/76 62 027
E-Mail: meierhoefer@binzel-abcicor.com



Klaus Göb
Tel.: 0 97 21/50 98 974
Handy: 01 71/76 62 028
E-Mail: goeb@binzel-abcicor.com



Matthias Zughorst
Tel.: 0 71 41/4813 55
Handy: 01 71/76 62 022
E-Mail: zughorst@binzel-abcicor.com

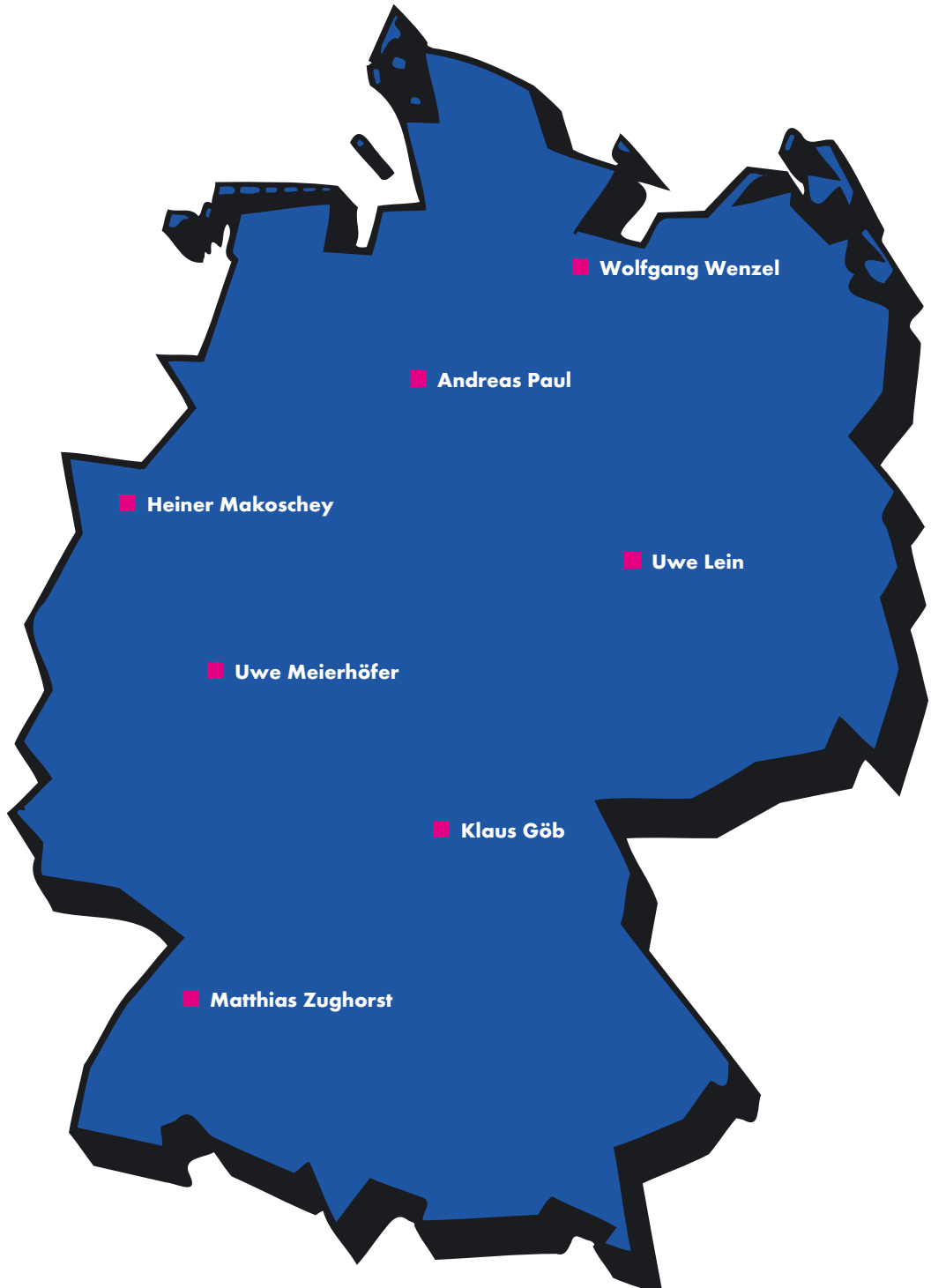

Ihre Ansprechpartner im Innendienst ...



Jörg Lehnhäuser
Direktor Vertrieb Deutschland
Tel.: 0 64 08/59-280
E-Mail: lehnhaeuser.j@binzel-abicor.com



Diana Hofmann
Sekretariat Vertrieb Deutschland
Tel.: 0 64 08/59-116
E-Mail: hofmann.d@binzel-abicor.com



Thomas Sohn
Gruppenleiter Vertrieb Deutschland
Tel.: 0 64 08/59-107
E-Mail: sohn.t@binzel-abicor.com



Stephan Bartel
Kundenberater Vertrieb Deutschland
Tel.: 0 64 08/59-110
E-Mail: bartel@binzel-abicor.com



Carsten Crombach
Kundenberater Vertrieb Deutschland
Tel.: 0 64 08/59-167
E-Mail: crombach@binzel-abicor.com



Birgit Dittrich
Kundenberaterin Vertrieb Deutschland
Tel.: 0 64 08/59-112
E-Mail: dittrich@binzel-abicor.com



Andreas Faber
Kundenberater Vertrieb Deutschland
Tel.: 0 64 08/59-121
E-Mail: faber.a@binzel-abicor.com



Bianka Koch
Kundenberaterin Vertrieb Deutschland
Tel.: 0 64 08/59-109
E-Mail: koch@binzel-abicor.com



Markus Preis
Kundenberater Vertrieb Deutschland
Tel.: 0 64 08/59-123
E-Mail: preis@binzel-abicor.com



Jörg Reips
Customer Service Vertrieb Deutschland
Tel.: 0 64 08/59-255
E-Mail: reips@binzel-abicor.com



Andrea Sann
Kundenberaterin Vertrieb Deutschland
Tel.: 0 64 08/59-212
E-Mail: sann@binzel-abicor.com



Erläuterung zur ABITIG®-Brennerpreisliste

Abkürzungen zu den Abbildungen:

iso.	isoliert
G	Gas
→	Kühlmittelrücklauf rot
←	Kühlmittelvorlauf blau

Abkürzungen für maschinenseitige Anschlüsse:

EA	Einzelanschluß
BSB 10-25	Schweißkabelstecker 10-25 (Ø 9 mm)
BSB 35-50	Schweißkabelstecker 35-50 (Ø 13 mm)
ZA-GZ	WIG-Zentralanschluß für luftgekühlte Brenner
ZA-WZ-0	WIG-Zentralanschluß für flüssiggekühlte Brenner
ZA-WTG-5	WIG-Zentralanschluß für luftgekühlte Brenner mit integrierter Steuerleitung
ZA-WTW-5	WIG-Zentralanschluß für flüssiggekühlte Brenner mit integrierter Steuerleitung
ZA 9-pol.	Zentralanschluß Mechafin (z. B. für „esab“, „kemppi“, „migatron“)“)
cloos	Anschluß für „cloos“-Schweißanlagen
BSB/CG	Kombistecker (Strom- und Gasführung geht über den Stecker)
dalex - BSB/CF	„dalex“ Kombistecker (Kühlflüssigkeitsführung durch den Stecker)
oerlikon - ZA	Stecker für „oerlikon“-Anlagen
MAG ZA	Für Kombi-Geräte (Cloos/Lorch/Merkle/Stell)
TCG	Kombistecker-Merkle

Anmerkungen zu den Schlauchpaketen:

Standard:	Kugelgelenk am Griff, Überzugschlauch Gummi durchgehend, Stromkabel mit PVC-Schlauch.
High Flex:	Kugelgelenk am Griff, 80 cm Lederschlauch, BiClip-Verbindung zum Gummiüberzugschlauch, Alle Schläuche hochflexibel mit Gummigewebeschlauch.
Schlauchpaketlängen:	Alle Varianten-Komplettbrenner sind auch in 12 und 16 Meter lieferbar.

Wichtiger Hinweis:

Die Angaben zu der Steckerbelegung sind nach dem Kenntnisstand von ABICOR BINZEL identisch mit der Originalbelegung des entsprechenden Geräteherstellers. Für die Angaben können wir jedoch keine Garantie übernehmen. Die Schlauchpakete werden mit der dargestellten Belegung ausgeliefert, es sei denn, bei Ihrer Bestellung wird eine andere Belegung vorgegeben.

Sollte sich unsererseits ein Fehler eingeschlichen haben, bitten wir um Ihre Rückmeldung.

Anmerkungen zu den Brennerkörperausführungen:

Die Brenner ABITIG® 18 , 26, 200 und 450 W sind auch in der Brennerkörperausführung „kurz“ lieferbar.
Die Brenner ABITIG® 20 F sind auch in den Brennerkörperlängen 30 und 65 mm verlängert lieferbar.

Abkürzungen für Schalterfunktion:

ED	Einzeldrucktaster
DD	Doppeldrucktaster
UD	Up/Down (zwei Wippen)
EDP*	Einzeldrucktaster mit Potentiometer 10 k Ω , andere Werte auf Anfrage (z.B. 1,0 k Ω , 2,2 k Ω , 4,7 k Ω , 47 k Ω)
DDP*	Doppeldrucktaster mit Potentiometer 10 k Ω , andere Werte auf Anfrage (z.B. 1,0 k Ω , 2,2 k Ω , 4,7 k Ω , 47 k Ω)

* Bei Potentiometerregelung im Handgriff ist ein HF-Filter dann zwingend notwendig, wenn die Poti-Leitung über die Fernreglerbuchse geführt und mit Hochspannungsimpulsen gezündet wird. Bei fehlendem HF-Filter kann es – durch die HF Impulse – zu Schäden an der Steuerelektronik kommen.
Bitte bestellen Sie den HF-Steuerleitungsfilter DGF 3 mit folgender Bestell-Nr.: 184.0162

Erläuterung zur ABITIG® GRIP-Brennerpreisliste

Alternativen zu den Standard-Ansteuermodulen (BIS):

Bedingt durch die grosse Anzahl von Ausführungsvarianten wäre es zu umfangreich, alle Brenner mit allen Ansteuermodulen aufzuführen. Daher hat ABICOR BINZEL in dieser Brennerpreisliste Standard-Module definiert (z. B. BIS-52 bei Doppeldruck). Alternativen dazu finden Sie unten aufgeführt.

Bei den vom Standard abweichenden Bestellungen tauschen Sie bitte das Standard-Ansteuermodul an den markierten Positionen durch das von Ihnen gewünschte Ansteuermodul aus.

Bestell-Nummer:

													x	x					
--	--	--	--	--	--	--	--	--	--	--	--	--	----------	----------	--	--	--	--	--

Ansteuermodul BIS

Hier bitte das alternativ gewünschte Ansteuermodul einsetzen, z. B. statt 52 = 60

Handgriff ABITIG® GRIP Little



BIS-51
ED = Einzeldruck



BIS-52
DD = Doppeldruck
Taster kurz
(In der Brennerpreisliste
Standard bei DD)



BIS-65
UD = UP/DOWN
(Geräteabhängig)



zugehörige Griffschale
Bestell-Nr. 180.0131.1

Handgriff ABITIG® GRIP



BIS-51
ED = Einzeldruck



BIS-52
DD = Doppeldruck/Taster lang



BIS-54
DDP = Doppeldruck/Poti
10 K-Ohm



BIS-59
EDP = Einzeldruck/Poti
10 K-Ohm
(Kompatibel zu Migatronic)



BIS-60
DD = Doppeldruck/Taster lang
für höhere Einschaltströme bis 2 A
(z. B. Dalex, Messer-Lincoln)



BIS-65
UD = UP/DOWN
(Geräteabhängig)



BIS-67
DD = Doppeldruck/Wippe



BIS-95
UD = UP/DOWN
(Kompatibel zu Lorch)



zugehörige Griffschale
Bestell-Nr. 180.0130.1

ABITIG® GRIP / ABITIG® GRIP Little-Brennerpreisliste

passend für WIG-Stromquellen des Fabrikates „artec“



Brennertyp	Länge	Schalterfunktion	maschinenseitiger Anschluss	Schlauchpaketausführung	Bestellnummer
ABITIG® 9	4 m	ED	BSB 35-50 Tuchel 5-pol.	Standard	7S1SK043510006A06
	8 m	ED	BSB 35-50 Tuchel 5-pol.	Standard	7S1SK083510006A06
	4 m	ED	BSB 35-50 Tuchel 5-pol.	High Flex Leder	7S1SH043510006A06
	8 m	ED	BSB 35-50 Tuchel 5-pol.	High Flex Leder	7S1SH083510006A06
ABITIG® 9 Little	4 m	ED	BSB 35-50 Tuchel 5-pol.	High Flex Leder	7L1SH043510006A06
	8 m	ED	BSB 35-50 Tuchel 5-pol.	High Flex Leder	7L1SH083510006A06
ABITIG® 9F	4 m	ED	BSB 35-50 Tuchel 5-pol.	Standard	7S1FK043510006A06
	8 m	ED	BSB 35-50 Tuchel 5-pol.	Standard	7S1FK083510006A06
	4 m	ED	BSB 35-50 Tuchel 5-pol.	High Flex Leder	7S1FH043510006A06
	8 m	ED	BSB 35-50 Tuchel 5-pol.	High Flex Leder	7S1FH083510006A06
ABITIG® 9F Little	4 m	ED	BSB 35-50 Tuchel 5-pol.	High Flex Leder	7L1FH043510006A06
	8 m	ED	BSB 35-50 Tuchel 5-pol.	High Flex Leder	7L1FH083510006A06
ABITIG® 17	4 m	ED	BSB 35-50 Tuchel 5-pol.	Standard	7S2SK043510006A06
	8 m	ED	BSB 35-50 Tuchel 5-pol.	Standard	7S2SK083510006A06
	4 m	ED	BSB 35-50 Tuchel 5-pol.	High Flex Leder	7S2SH043510006A06
	8 m	ED	BSB 35-50 Tuchel 5-pol.	High Flex Leder	7S2SH083510006A06
ABITIG® 17 Little	4 m	ED	BSB 35-50 Tuchel 5-pol.	High Flex Leder	7L2SH043510006A06
	8 m	ED	BSB 35-50 Tuchel 5-pol.	High Flex Leder	7L2SH083510006A06
ABITIG® 17F	4 m	ED	BSB 35-50 Tuchel 5-pol.	Standard	7S2FK043510006A06
	8 m	ED	BSB 35-50 Tuchel 5-pol.	Standard	7S2FK083510006A06
	4 m	ED	BSB 35-50 Tuchel 5-pol.	High Flex Leder	7S2FH043510006A06
	8 m	ED	BSB 35-50 Tuchel 5-pol.	High Flex Leder	7S2FH083510006A06
ABITIG® 17F Little	4 m	ED	BSB 35-50 Tuchel 5-pol.	High Flex Leder	7L2FH043510006A06
	8 m	ED	BSB 35-50 Tuchel 5-pol.	High Flex Leder	7L2FH083510006A06

Technische Änderungen vorbehalten • Verkaufspreise = unverbindliche Preisempfehlung - Angebot freibleibend • © Copyright

ABITIG® GRIP / ABITIG® GRIP Little-Brennerpreisliste

passend für WIG-Stromquellen des Fabrikates „artec“

Brennertyp	Länge	Schalterfunktion	maschinenseitiger Anschluss	Schlauchpaketausführung	Bestellnummer
ABITIG® 26	4 m	ED	BSB 35-50 Tuchel 5-pol.	Standard	7S3SK043510006A06
	8 m	ED	BSB 35-50 Tuchel 5-pol.	Standard	7S3SK083510006A06
	4 m	ED	BSB 35-50 Tuchel 5-pol.	High Flex Leder	7S3SH043510006A06
	8 m	ED	BSB 35-50 Tuchel 5-pol.	High Flex Leder	7S3SH083510006A06
ABITIG® 26F	4 m	ED	BSB 35-50 Tuchel 5-pol.	Standard	7S3FK043510006A06
	8 m	ED	BSB 35-50 Tuchel 5-pol.	Standard	7S3FK083510006A06
	4 m	ED	BSB 35-50 Tuchel 5-pol.	High Flex Leder	7S3FH043510006A06
	8 m	ED	BSB 35-50 Tuchel 5-pol.	High Flex Leder	7S3FH083510006A06
ABITIG® 24G	4 m	ED	BSB 35-50 Tuchel 5-pol.	Standard	7S8SK043510006A06
	8 m	ED	BSB 35-50 Tuchel 5-pol.	Standard	7S8SK083510006A06
	4 m	ED	BSB 35-50 Tuchel 5-pol.	High Flex Leder	7S8SH043510006A06
	8 m	ED	BSB 35-50 Tuchel 5-pol.	High Flex Leder	7S8SH083510006A06
ABITIG® 24G Little	4 m	ED	BSB 35-50 Tuchel 5-pol.	High Flex Leder	7L8SH043510006A06
	8 m	ED	BSB 35-50 Tuchel 5-pol.	High Flex Leder	7L8SH083510006A06
ABITIG® 200	4 m	ED	BSB 35-50 Tuchel 5-pol.	Standard	7T4SK043510006A06
	8 m	ED	BSB 35-50 Tuchel 5-pol.	Standard	7T4SK083510006A06
	4 m	ED	BSB 35-50 Tuchel 5-pol.	High Flex Leder	7T4SH043510006A06
	8 m	ED	BSB 35-50 Tuchel 5-pol.	High Flex Leder	7T4SH083510006A06
ABITIG® 200F	4 m	ED	BSB 35-50 Tuchel 5-pol.	Standard	7T4FK043510006A06
	8 m	ED	BSB 35-50 Tuchel 5-pol.	Standard	7T4FK083510006A06
	4 m	ED	BSB 35-50 Tuchel 5-pol.	High Flex Leder	7T4FH043510006A06
	8 m	ED	BSB 35-50 Tuchel 5-pol.	High Flex Leder	7T4FH083510006A06
ABITIG® 150	4 m	ED	BSB 35-50 Tuchel 5-pol.	Standard	7T6SK043510006A06
	8 m	ED	BSB 35-50 Tuchel 5-pol.	Standard	7T6SK083510006A06
	4 m	ED	BSB 35-50 Tuchel 5-pol.	High Flex Leder	7T6SH043510006A06
	8 m	ED	BSB 35-50 Tuchel 5-pol.	High Flex Leder	7T6SH083510006A06
ABITIG® 150 Little	4 m	ED	BSB 35-50 Tuchel 5-pol.	High Flex Leder	7L6SH043510006A06
	8 m	ED	BSB 35-50 Tuchel 5-pol.	High Flex Leder	7L6SH083510006A06
ABITIG® 150F	4 m	ED	BSB 35-50 Tuchel 5-pol.	Standard	7T6FK043510006A06
	8 m	ED	BSB 35-50 Tuchel 5-pol.	Standard	7T6FK083510006A06
	4 m	ED	BSB 35-50 Tuchel 5-pol.	High Flex Leder	7T6FH043510006A06
	8 m	ED	BSB 35-50 Tuchel 5-pol.	High Flex Leder	7T6FH083510006A06
ABITIG® 150F Little	4 m	ED	BSB 35-50 Tuchel 5-pol.	High Flex Leder	7L6FH043510006A06
	8 m	ED	BSB 35-50 Tuchel 5-pol.	High Flex Leder	7L6FH083510006A06

ABITIG® GRIP / ABITIG® GRIP Little-Brennerpreisliste

passend für WIG-Stromquellen des Fabrikates „artec“



Brennertyp	Länge	Schalterfunktion	maschinenseitiger Anschluss	Schlauchpaketausführung	Bestellnummer
ABITIG® 9	4 m	DD	BSB 35-50 Tuchel 5-pol.	Standard	7S1SK043520001B06
	8 m	DD	BSB 35-50 Tuchel 5-pol.	Standard	7S1SK083520001B06
	4 m	DD	BSB 35-50 Tuchel 5-pol.	High Flex Leder	7S1SH043520001B06
	8 m	DD	BSB 35-50 Tuchel 5-pol.	High Flex Leder	7S1SH083520001B06
ABITIG® 9 Little	4 m	DD	BSB 35-50 Tuchel 5-pol.	High Flex Leder	7L1SH043520001B06
	8 m	DD	BSB 35-50 Tuchel 5-pol.	High Flex Leder	7L1SH083520001B06
ABITIG® 9F	4 m	DD	BSB 35-50 Tuchel 5-pol.	Standard	7S1FK043520001B06
	8 m	DD	BSB 35-50 Tuchel 5-pol.	Standard	7S1FK083520001B06
	4 m	DD	BSB 35-50 Tuchel 5-pol.	High Flex Leder	7S1FH043520001B06
	8 m	DD	BSB 35-50 Tuchel 5-pol.	High Flex Leder	7S1FH083520001B06
ABITIG® 9F Little	4 m	DD	BSB 35-50 Tuchel 5-pol.	High Flex Leder	7L1FH043520001B06
	8 m	DD	BSB 35-50 Tuchel 5-pol.	High Flex Leder	7L1FH083520001B06
ABITIG® 17	4 m	DD	BSB 35-50 Tuchel 5-pol.	Standard	7S2SK043520001B06
	8 m	DD	BSB 35-50 Tuchel 5-pol.	Standard	7S2SK083520001B06
	4 m	DD	BSB 35-50 Tuchel 5-pol.	High Flex Leder	7S2SH043520001B06
	8 m	DD	BSB 35-50 Tuchel 5-pol.	High Flex Leder	7S2SH083520001B06
ABITIG® 17 Little	4 m	DD	BSB 35-50 Tuchel 5-pol.	High Flex Leder	7L2SH043520001B06
	8 m	DD	BSB 35-50 Tuchel 5-pol.	High Flex Leder	7L2SH083520001B06
ABITIG® 17F	4 m	DD	BSB 35-50 Tuchel 5-pol.	Standard	7S2FK043520001B06
	8 m	DD	BSB 35-50 Tuchel 5-pol.	Standard	7S2FK083520001B06
	4 m	DD	BSB 35-50 Tuchel 5-pol.	High Flex Leder	7S2FH043520001B06
	8 m	DD	BSB 35-50 Tuchel 5-pol.	High Flex Leder	7S2FH083520001B06
ABITIG® 17F Little	4 m	DD	BSB 35-50 Tuchel 5-pol.	High Flex Leder	7L2FH043520001B06
	8 m	DD	BSB 35-50 Tuchel 5-pol.	High Flex Leder	7L2FH083520001B06

Technische Änderungen vorbehalten • Verkaufspreise = unverbindliche Preisempfehlung - Angebot freibleibend • © Copyright

ABITIG® GRIP / ABITIG® GRIP Little-Brennerpreisliste

passend für WIG-Stromquellen des Fabrikates „artec“

Brennertyp	Länge	Schalterfunktion	maschinenseitiger Anschluss	Schlauchpaketausführung	Bestellnummer
ABITIG® 26	4 m	DD	BSB 35-50 Tuchel 5-pol.	Standard	7S3SK043520001B06
	8 m	DD	BSB 35-50 Tuchel 5-pol.	Standard	7S3SK083520001B06
	4 m	DD	BSB 35-50 Tuchel 5-pol.	High Flex Leder	7S3SH043520001B06
	8 m	DD	BSB 35-50 Tuchel 5-pol.	High Flex Leder	7S3SH083520001B06
ABITIG® 26F	4 m	DD	BSB 35-50 Tuchel 5-pol.	Standard	7S3FK043520001B06
	8 m	DD	BSB 35-50 Tuchel 5-pol.	Standard	7S3FK083520001B06
	4 m	DD	BSB 35-50 Tuchel 5-pol.	High Flex Leder	7S3FH043520001B06
	8 m	DD	BSB 35-50 Tuchel 5-pol.	High Flex Leder	7S3FH083520001B06
ABITIG® 24G	4 m	DD	BSB 35-50 Tuchel 5-pol.	Standard	7S8SK043520001B06
	8 m	DD	BSB 35-50 Tuchel 5-pol.	Standard	7S8SK083520001B06
	4 m	DD	BSB 35-50 Tuchel 5-pol.	High Flex Leder	7S8SH043520001B06
	8 m	DD	BSB 35-50 Tuchel 5-pol.	High Flex Leder	7S8SH083520001B06
ABITIG® 24G Little	4 m	DD	BSB 35-50 Tuchel 5-pol.	High Flex Leder	7L8SH043520001B06
	8 m	DD	BSB 35-50 Tuchel 5-pol.	High Flex Leder	7L8SH083520001B06
ABITIG® 200	4 m	DD	BSB 35-50 Tuchel 5-pol.	Standard	7T4SK043520001B06
	8 m	DD	BSB 35-50 Tuchel 5-pol.	Standard	7T4SK083520001B06
	4 m	DD	BSB 35-50 Tuchel 5-pol.	High Flex Leder	7T4SH043520001B06
	8 m	DD	BSB 35-50 Tuchel 5-pol.	High Flex Leder	7T4SH083520001B06
ABITIG® 200F	4 m	DD	BSB 35-50 Tuchel 5-pol.	Standard	7T4FK043520001B06
	8 m	DD	BSB 35-50 Tuchel 5-pol.	Standard	7T4FK083520001B06
	4 m	DD	BSB 35-50 Tuchel 5-pol.	High Flex Leder	7T4FH043520001B06
	8 m	DD	BSB 35-50 Tuchel 5-pol.	High Flex Leder	7T4FH083520001B06
ABITIG® 150	4 m	DD	BSB 35-50 Tuchel 5-pol.	Standard	7T6SK043520001B06
	8 m	DD	BSB 35-50 Tuchel 5-pol.	Standard	7T6SK083520001B06
	4 m	DD	BSB 35-50 Tuchel 5-pol.	High Flex Leder	7T6SH043520001B06
	8 m	DD	BSB 35-50 Tuchel 5-pol.	High Flex Leder	7T6SH083520001B06
ABITIG® 150 Little	4 m	DD	BSB 35-50 Tuchel 5-pol.	High Flex Leder	7L6SH043520001B06
	8 m	DD	BSB 35-50 Tuchel 5-pol.	High Flex Leder	7L6SH083520001B06
ABITIG® 150F	4 m	DD	BSB 35-50 Tuchel 5-pol.	Standard	7T6FK043520001B06
	8 m	DD	BSB 35-50 Tuchel 5-pol.	Standard	7T6FK083520001B06
	4 m	DD	BSB 35-50 Tuchel 5-pol.	High Flex Leder	7T6FH043520001B06
	8 m	DD	BSB 35-50 Tuchel 5-pol.	High Flex Leder	7T6FH083520001B06
ABITIG® 150F Little	4 m	DD	BSB 35-50 Tuchel 5-pol.	High Flex Leder	7L6FH043520001B06
	8 m	DD	BSB 35-50 Tuchel 5-pol.	High Flex Leder	7L6FH083520001B06

ABITIG® GRIP / ABITIG® GRIP Little-Brennerpreisliste

passend für WIG-Stromquellen des Fabrikates „artec“



Brennertyp	Länge	Schalterfunktion	maschinenseitiger Anschluss	Schlauchpaketausführung	Bestellnummer
ABITIG® 18	4 m	ED	BSB 35-50 Tuchel 5-pol.	Standard	7S4SK043510002A20
	8 m	ED	BSB 35-50 Tuchel 5-pol.	Standard	7S4SK083510002A20
	4 m	ED	BSB 35-50 Tuchel 5-pol.	High Flex Leder	7S4SH043510002A20
	8 m	ED	BSB 35-50 Tuchel 5-pol.	High Flex Leder	7S4SH083510002A20
ABITIG® 18F	4 m	ED	BSB 35-50 Tuchel 5-pol.	Standard	7S4FK043510002A20
	8 m	ED	BSB 35-50 Tuchel 5-pol.	Standard	7S4FK083510002A20
	4 m	ED	BSB 35-50 Tuchel 5-pol.	High Flex Leder	7S4FH043510002A20
	8 m	ED	BSB 35-50 Tuchel 5-pol.	High Flex Leder	7S4FH083510002A20
ABITIG® 20	4 m	ED	BSB 35-50 Tuchel 5-pol.	Standard	7S5SK043510002A20
	8 m	ED	BSB 35-50 Tuchel 5-pol.	Standard	7S5SK083510002A20
	4 m	ED	BSB 35-50 Tuchel 5-pol.	High Flex Leder	7S5SH043510002A20
	8 m	ED	BSB 35-50 Tuchel 5-pol.	High Flex Leder	7S5SH083510002A20
ABITIG® 20 Little	4 m	ED	BSB 35-50 Tuchel 5-pol.	High Flex Leder	7L5SH043510002A20
	8 m	ED	BSB 35-50 Tuchel 5-pol.	High Flex Leder	7L5SH083510002A20
ABITIG® 20F	4 m	ED	BSB 35-50 Tuchel 5-pol.	Standard	7S5FK043510002A20
	8 m	ED	BSB 35-50 Tuchel 5-pol.	Standard	7S5FK083510002A20
	4 m	ED	BSB 35-50 Tuchel 5-pol.	High Flex Leder	7S5FH043510002A20
	8 m	ED	BSB 35-50 Tuchel 5-pol.	High Flex Leder	7S5FH083510002A20
ABITIG® 20F Little	4 m	ED	BSB 35-50 Tuchel 5-pol.	High Flex Leder	7L5FH043510002A20
	8 m	ED	BSB 35-50 Tuchel 5-pol.	High Flex Leder	7L5FH083510002A20

Technische Änderungen vorbehalten • Verkaufspreise = unverbindliche Preisempfehlung - Angebot freibleibend • © Copyright

ABITIG® GRIP / ABITIG® GRIP Little-Brennerpreisliste

passend für WIG-Stromquellen des Fabrikates „artec“

Brennertyp	Länge	Schalterfunktion	maschinenseitiger Anschluss	Schlauchpaketausführung	Bestellnummer
ABITIG® 12-1	4 m	ED	BSB 35-50 Tuchel 5-pol.	Standard	7S6SK043510002A20
	8 m	ED	BSB 35-50 Tuchel 5-pol.	Standard	7S6SK083510002A20
	4 m	ED	BSB 35-50 Tuchel 5-pol.	High Flex Leder	7S6SH043510002A20
	8 m	ED	BSB 35-50 Tuchel 5-pol.	High Flex Leder	7S6SH083510002A20
ABITIG® 18SC	4 m	ED	BSB 35-50 Tuchel 5-pol.	Standard	7S7SK043510002A20
	8 m	ED	BSB 35-50 Tuchel 5-pol.	Standard	7S7SK083510002A20
	4 m	ED	BSB 35-50 Tuchel 5-pol.	High Flex Leder	7S7SH043510002A20
	8 m	ED	BSB 35-50 Tuchel 5-pol.	High Flex Leder	7S7SH083510002A20
ABITIG® 24W	4 m	ED	BSB 35-50 Tuchel 5-pol.	Standard	7S9SK043510002A20
	8 m	ED	BSB 35-50 Tuchel 5-pol.	Standard	7S9SK083510002A20
	4 m	ED	BSB 35-50 Tuchel 5-pol.	High Flex Leder	7S9SH043510002A20
	8 m	ED	BSB 35-50 Tuchel 5-pol.	High Flex Leder	7S9SH083510002A20
ABITIG® 24W Little	4 m	ED	BSB 35-50 Tuchel 5-pol.	High Flex Leder	7L9SH043510002A20
	8 m	ED	BSB 35-50 Tuchel 5-pol.	High Flex Leder	7L9SH083510002A20
ABITIG® 450W	4 m	ED	BSB 35-50 Tuchel 5-pol.	Standard	7T5SK043510102A20
	8 m	ED	BSB 35-50 Tuchel 5-pol.	Standard	7T5SK083510102A20
	4 m	ED	BSB 35-50 Tuchel 5-pol.	High Flex Leder	7T5SH043510102A20
	8 m	ED	BSB 35-50 Tuchel 5-pol.	High Flex Leder	7T5SH083510102A20
ABITIG® 260W	4 m	ED	BSB 35-50 Tuchel 5-pol.	Standard	7T7SK043510102A20
	8 m	ED	BSB 35-50 Tuchel 5-pol.	Standard	7T7SK083510102A20
	4 m	ED	BSB 35-50 Tuchel 5-pol.	High Flex Leder	7T7SH043510102A20
	8 m	ED	BSB 35-50 Tuchel 5-pol.	High Flex Leder	7T7SH083510102A20
ABITIG® 260W Little	4 m	ED	BSB 35-50 Tuchel 5-pol.	High Flex Leder	7L7SH043510102A20
	8 m	ED	BSB 35-50 Tuchel 5-pol.	High Flex Leder	7L7SH083510102A20
ABITIG® 450W SC	4 m	ED	BSB 35-50 Tuchel 5-pol.	Standard	
	8 m	ED	BSB 35-50 Tuchel 5-pol.	Standard	
	4 m	ED	BSB 35-50 Tuchel 5-pol.	High Flex Leder	7T8SH043510102A20
	8 m	ED	BSB 35-50 Tuchel 5-pol.	High Flex Leder	7T8SH083510102A20

ABITIG® GRIP / ABITIG® GRIP Little-Brennerpreisliste

passend für WIG-Stromquellen des Fabrikates „artec“



Brennertyp	Länge	Schalterfunktion	maschinenseitiger Anschluss	Schlauchpaketausführung	Bestellnummer
ABITIG® 18	4 m	DD	BSB 35-50 Tuchel 5-pol.	Standard	7S4SK043520001B20
	8 m	DD	BSB 35-50 Tuchel 5-pol.	Standard	7S4SK083520001B20
	4 m	DD	BSB 35-50 Tuchel 5-pol.	High Flex Leder	7S4SH043520001B20
	8 m	DD	BSB 35-50 Tuchel 5-pol.	High Flex Leder	7S4SH083520001B20
ABITIG® 18F	4 m	DD	BSB 35-50 Tuchel 5-pol.	Standard	7S4FK043520001B20
	8 m	DD	BSB 35-50 Tuchel 5-pol.	Standard	7S4FK083520001B20
	4 m	DD	BSB 35-50 Tuchel 5-pol.	High Flex Leder	7S4FH043520001B20
	8 m	DD	BSB 35-50 Tuchel 5-pol.	High Flex Leder	7S4FH083520001B20
ABITIG® 20	4 m	DD	BSB 35-50 Tuchel 5-pol.	Standard	7S5SK043520001B20
	8 m	DD	BSB 35-50 Tuchel 5-pol.	Standard	7S5SK083520001B20
	4 m	DD	BSB 35-50 Tuchel 5-pol.	High Flex Leder	7S5SH043520001B20
	8 m	DD	BSB 35-50 Tuchel 5-pol.	High Flex Leder	7S5SH083520001B20
ABITIG® 20 Little	4 m	DD	BSB 35-50 Tuchel 5-pol.	High Flex Leder	7L5SH043520001B20
	8 m	DD	BSB 35-50 Tuchel 5-pol.	High Flex Leder	7L5SH083520001B20
ABITIG® 20F	4 m	DD	BSB 35-50 Tuchel 5-pol.	Standard	7S5FK043520001B20
	8 m	DD	BSB 35-50 Tuchel 5-pol.	Standard	7S5FK083520001B20
	4 m	DD	BSB 35-50 Tuchel 5-pol.	High Flex Leder	7S5FH043520001B20
	8 m	DD	BSB 35-50 Tuchel 5-pol.	High Flex Leder	7S5FH083520001B20
ABITIG® 20F Little	4 m	DD	BSB 35-50 Tuchel 5-pol.	High Flex Leder	7L5FH043520001B20
	8 m	DD	BSB 35-50 Tuchel 5-pol.	High Flex Leder	7L5FH083520001B20

Technische Änderungen vorbehalten • Verkaufspreise = unverbindliche Preisempfehlung - Angebot freibleibend • © Copyright

ABITIG® GRIP / ABITIG® GRIP Little-Brennerpreisliste

passend für WIG-Stromquellen des Fabrikates „artec“

Brennertyp	Länge	Schalterfunktion	maschinenseitiger Anschluss	Schlauchpaketausführung	Bestellnummer
ABITIG® 12-1	4 m	DD	BSB 35-50 Tuchel 5-pol.	Standard	7S6SK043520001B20
	8 m	DD	BSB 35-50 Tuchel 5-pol.	Standard	7S6SK083520001B20
	4 m	DD	BSB 35-50 Tuchel 5-pol.	High Flex Leder	7S6SH043520001B20
	8 m	DD	BSB 35-50 Tuchel 5-pol.	High Flex Leder	7S6SH083520001B20
ABITIG® 18SC	4 m	DD	BSB 35-50 Tuchel 5-pol.	Standard	7S7SK043520001B20
	8 m	DD	BSB 35-50 Tuchel 5-pol.	Standard	7S7SK083520001B20
	4 m	DD	BSB 35-50 Tuchel 5-pol.	High Flex Leder	7S7SH043520001B20
	8 m	DD	BSB 35-50 Tuchel 5-pol.	High Flex Leder	7S7SH083520001B20
ABITIG® 24W	4 m	DD	BSB 35-50 Tuchel 5-pol.	Standard	7S9SK043520001B20
	8 m	DD	BSB 35-50 Tuchel 5-pol.	Standard	7S9SK083520001B20
	4 m	DD	BSB 35-50 Tuchel 5-pol.	High Flex Leder	7S9SH043520001B20
	8 m	DD	BSB 35-50 Tuchel 5-pol.	High Flex Leder	7S9SH083520001B20
ABITIG® 24W Little	4 m	DD	BSB 35-50 Tuchel 5-pol.	High Flex Leder	7L9SH043520001B20
	8 m	DD	BSB 35-50 Tuchel 5-pol.	High Flex Leder	7L9SH083520001B20
ABITIG® 450W	4 m	DD	BSB 35-50 Tuchel 5-pol.	Standard	7T5SK043520101B20
	8 m	DD	BSB 35-50 Tuchel 5-pol.	Standard	7T5SK083520101B20
	4 m	DD	BSB 35-50 Tuchel 5-pol.	High Flex Leder	7T5SH043520101B20
	8 m	DD	BSB 35-50 Tuchel 5-pol.	High Flex Leder	7T5SH083520101B20
ABITIG® 260W	4 m	DD	BSB 35-50 Tuchel 5-pol.	Standard	7T7SK043520101B20
	8 m	DD	BSB 35-50 Tuchel 5-pol.	Standard	7T7SK083520101B20
	4 m	DD	BSB 35-50 Tuchel 5-pol.	High Flex Leder	7T7SH043520101B20
	8 m	DD	BSB 35-50 Tuchel 5-pol.	High Flex Leder	7T7SH083520101B20
ABITIG® 260W Little	4 m	DD	BSB 35-50 Tuchel 5-pol.	High Flex Leder	7L7SH043520101B20
	8 m	DD	BSB 35-50 Tuchel 5-pol.	High Flex Leder	7L7SH083520101B20
ABITIG® 450W SC	4 m	DD	BSB 35-50 Tuchel 5-pol.	Standard	
	8 m	DD	BSB 35-50 Tuchel 5-pol.	Standard	
	4 m	DD	BSB 35-50 Tuchel 5-pol.	High Flex Leder	7T8SH043520101B20
	8 m	DD	BSB 35-50 Tuchel 5-pol.	High Flex Leder	7T8SH083520101B20

ABITIG® GRIP / ABITIG® GRIP Little-Brennerpreisliste

passend für WIG-Stromquellen des Fabrikates „bester“

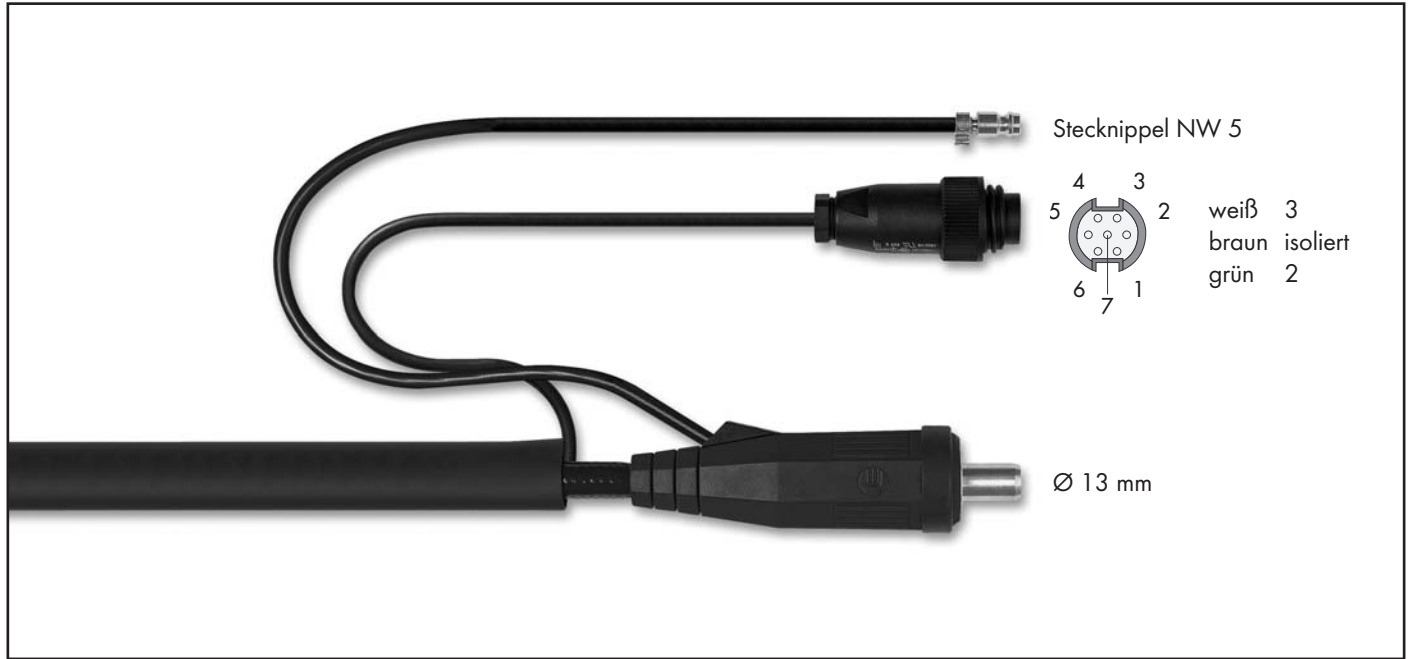

Brennertyp	Länge	Schalterfunktion	maschinenseitiger Anschluss	Schlauchpaketausführung	Bestellnummer
ABITIG® 9	4 m	ED	BSB 35-50 Rundsteckverbinder 7-pol.	Standard	7S1SK043510012B06
	8 m	ED	BSB 35-50 Rundsteckverbinder 7-pol.	Standard	7S1SK083510012B06
	4 m	ED	BSB 35-50 Rundsteckverbinder 7-pol.	High Flex Leder	7S1SH043510012B06
	8 m	ED	BSB 35-50 Rundsteckverbinder 7-pol.	High Flex Leder	7S1SH083510012B06
ABITIG® 9 Little	4 m	ED	BSB 35-50 Rundsteckverbinder 7-pol.	High Flex Leder	7L1SH043510012B06
	8 m	ED	BSB 35-50 Rundsteckverbinder 7-pol.	High Flex Leder	7L1SH083510012B06
ABITIG® 9F	4 m	ED	BSB 35-50 Rundsteckverbinder 7-pol.	Standard	7S1FK043510012B06
	8 m	ED	BSB 35-50 Rundsteckverbinder 7-pol.	Standard	7S1FK083510012B06
	4 m	ED	BSB 35-50 Rundsteckverbinder 7-pol.	High Flex Leder	7S1FH043510012B06
	8 m	ED	BSB 35-50 Rundsteckverbinder 7-pol.	High Flex Leder	7S1FH083510012B06
ABITIG® 9F Little	4 m	ED	BSB 35-50 Rundsteckverbinder 7-pol.	High Flex Leder	7L1FH043510012B06
	8 m	ED	BSB 35-50 Rundsteckverbinder 7-pol.	High Flex Leder	7L1FH083510012B06
ABITIG® 17	4 m	ED	BSB 35-50 Rundsteckverbinder 7-pol.	Standard	7S2SK043510012B06
	8 m	ED	BSB 35-50 Rundsteckverbinder 7-pol.	Standard	7S2SK083510012B06
	4 m	ED	BSB 35-50 Rundsteckverbinder 7-pol.	High Flex Leder	7S2SH043510012B06
	8 m	ED	BSB 35-50 Rundsteckverbinder 7-pol.	High Flex Leder	7S2SH083510012B06
ABITIG® 17 Little	4 m	ED	BSB 35-50 Rundsteckverbinder 7-pol.	High Flex Leder	7L2SH043510012B06
	8 m	ED	BSB 35-50 Rundsteckverbinder 7-pol.	High Flex Leder	7L2SH083510012B06
ABITIG® 17F	4 m	ED	BSB 35-50 Rundsteckverbinder 7-pol.	Standard	7S2FK043510012B06
	8 m	ED	BSB 35-50 Rundsteckverbinder 7-pol.	Standard	7S2FK083510012B06
	4 m	ED	BSB 35-50 Rundsteckverbinder 7-pol.	High Flex Leder	7S2FH043510012B06
	8 m	ED	BSB 35-50 Rundsteckverbinder 7-pol.	High Flex Leder	7S2FH083510012B06
ABITIG® 17F Little	4 m	ED	BSB 35-50 Rundsteckverbinder 7-pol.	High Flex Leder	7L2FH043510012B06
	8 m	ED	BSB 35-50 Rundsteckverbinder 7-pol.	High Flex Leder	7L2FH083510012B06

Technische Änderungen vorbehalten • Verkaufspreise = unverbindliche Preisempfehlung - Angebot freibleibend • © Copyright

ABITIG® GRIP / ABITIG® GRIP Little-Brennerpreisliste

passend für WIG-Stromquellen des Fabrikates „bester“

Brennertyp	Länge	Schalterfunktion	maschinenseitiger Anschluss	Schlauchpaketausführung	Bestellnummer
ABITIG® 26	4 m	ED	BSB 35-50 Rundsteckverbinder 7-pol.	Standard	7S3SK043510012B06
	8 m	ED	BSB 35-50 Rundsteckverbinder 7-pol.	Standard	7S3SK083510012B06
	4 m	ED	BSB 35-50 Rundsteckverbinder 7-pol.	High Flex Leder	7S3SH043510012B06
	8 m	ED	BSB 35-50 Rundsteckverbinder 7-pol.	High Flex Leder	7S3SH083510012B06
ABITIG® 26F	4 m	ED	BSB 35-50 Rundsteckverbinder 7-pol.	Standard	7S3FK043510012B06
	8 m	ED	BSB 35-50 Rundsteckverbinder 7-pol.	Standard	7S3FK083510012B06
	4 m	ED	BSB 35-50 Rundsteckverbinder 7-pol.	High Flex Leder	7S3FH043510012B06
	8 m	ED	BSB 35-50 Rundsteckverbinder 7-pol.	High Flex Leder	7S3FH083510012B06
ABITIG® 24G	4 m	ED	BSB 35-50 Rundsteckverbinder 7-pol.	Standard	7S8SK043510012B06
	8 m	ED	BSB 35-50 Rundsteckverbinder 7-pol.	Standard	7S8SK083510012B06
	8 m	ED	BSB 35-50 Rundsteckverbinder 7-pol.	High Flex Leder	7S8SH043510012B06
	4 m	ED	BSB 35-50 Rundsteckverbinder 7-pol.	High Flex Leder	7S8SH083510012B06
ABITIG® 24G Little	8 m	ED	BSB 35-50 Rundsteckverbinder 7-pol.	High Flex Leder	7L8SH043510012B06
	4 m	ED	BSB 35-50 Rundsteckverbinder 7-pol.	High Flex Leder	7L8SH083510012B06
ABITIG® 200	4 m	ED	BSB 35-50 Rundsteckverbinder 7-pol.	Standard	7T4SK043510012B06
	8 m	ED	BSB 35-50 Rundsteckverbinder 7-pol.	Standard	7T4SK083510012B06
	4 m	ED	BSB 35-50 Rundsteckverbinder 7-pol.	High Flex Leder	7T4SH043510012B06
	8 m	ED	BSB 35-50 Rundsteckverbinder 7-pol.	High Flex Leder	7T4SH083510012B06
ABITIG® 200F	4 m	ED	BSB 35-50 Rundsteckverbinder 7-pol.	Standard	7T4FK043510012B06
	8 m	ED	BSB 35-50 Rundsteckverbinder 7-pol.	Standard	7T4FK083510012B06
	4 m	ED	BSB 35-50 Rundsteckverbinder 7-pol.	High Flex Leder	7T4FH043510012B06
	8 m	ED	BSB 35-50 Rundsteckverbinder 7-pol.	High Flex Leder	7T4FH083510012B06
ABITIG® 150	4 m	ED	BSB 35-50 Rundsteckverbinder 7-pol.	Standard	7T6SK043510012B06
	8 m	ED	BSB 35-50 Rundsteckverbinder 7-pol.	Standard	7T6SK083510012B06
	4 m	ED	BSB 35-50 Rundsteckverbinder 7-pol.	High Flex Leder	7T6SH043510012B06
	8 m	ED	BSB 35-50 Rundsteckverbinder 7-pol.	High Flex Leder	7T6SH083510012B06
ABITIG® 150 Little	4 m	ED	BSB 35-50 Rundsteckverbinder 7-pol.	High Flex Leder	7L6SH043510012B06
	8 m	ED	BSB 35-50 Rundsteckverbinder 7-pol.	High Flex Leder	7L6SH083510012B06
ABITIG® 150F	4 m	ED	BSB 35-50 Rundsteckverbinder 7-pol.	Standard	7T6FK043510012B06
	8 m	ED	BSB 35-50 Rundsteckverbinder 7-pol.	Standard	7T6FK083510012B06
	4 m	ED	BSB 35-50 Rundsteckverbinder 7-pol.	High Flex Leder	7T6FH043510012B06
	8 m	ED	BSB 35-50 Rundsteckverbinder 7-pol.	High Flex Leder	7T6FH083510012B06
ABITIG® 150F Little	4 m	ED	BSB 35-50 Rundsteckverbinder 7-pol.	High Flex Leder	7L6FH043510012B06
	8 m	ED	BSB 35-50 Rundsteckverbinder 7-pol.	High Flex Leder	7L6FH083510012B06

ABITIG® GRIP / ABITIG® GRIP Little-Brennerpreisliste

passend für WIG-Stromquellen des Fabrikates „bester“

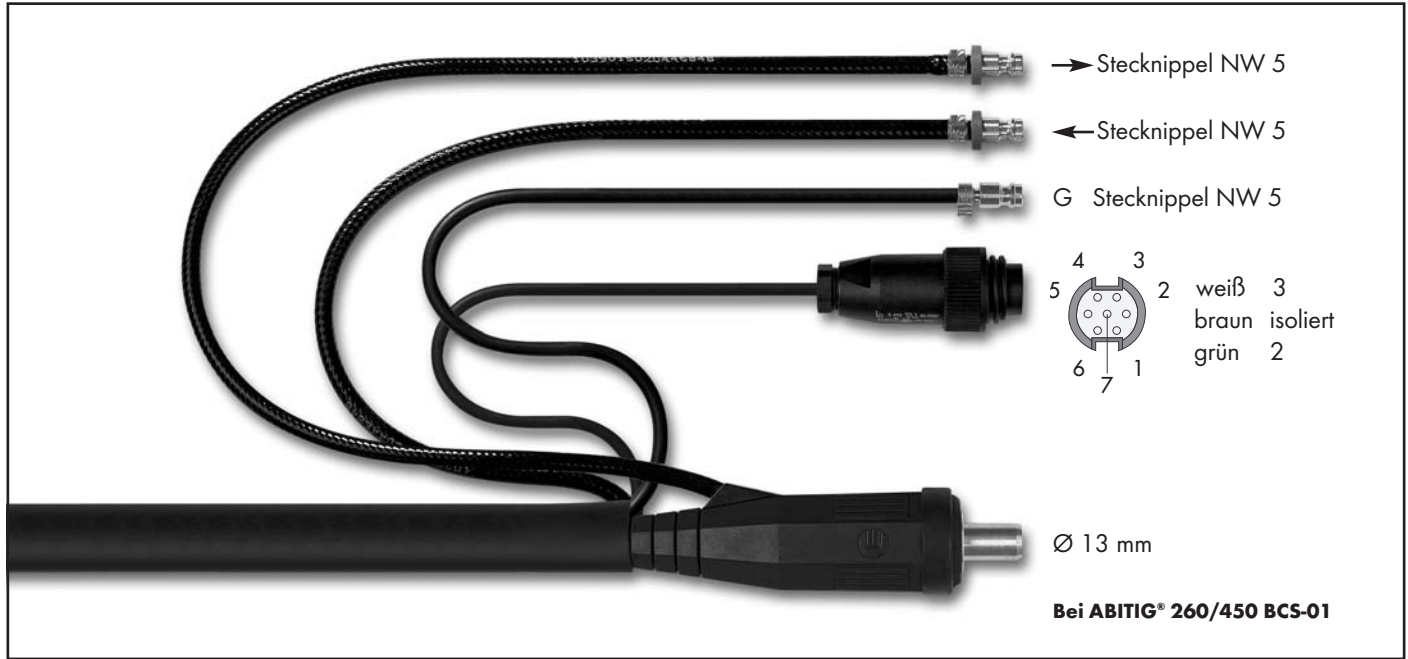

Brennertyp	Länge	Schalterfunktion	maschinenseitiger Anschluss	Schlauchpaketausführung	Bestellnummer
ABITIG® 18	4 m	ED	BSB 35-50 Rundsteckverbinder 7-pol.	Standard	7S4SK043510012B20
	8 m	ED	BSB 35-50 Rundsteckverbinder 7-pol.	Standard	7S4SK083510012B20
	4 m	ED	BSB 35-50 Rundsteckverbinder 7-pol.	High Flex Leder	7S4SH043510012B20
	8 m	ED	BSB 35-50 Rundsteckverbinder 7-pol.	High Flex Leder	7S4SH083510012B20
ABITIG® 18F	4 m	ED	BSB 35-50 Rundsteckverbinder 7-pol.	Standard	7S4FK043510012B20
	8 m	ED	BSB 35-50 Rundsteckverbinder 7-pol.	Standard	7S4FK083510012B20
	4 m	ED	BSB 35-50 Rundsteckverbinder 7-pol.	High Flex Leder	7S4FH043510012B20
	8 m	ED	BSB 35-50 Rundsteckverbinder 7-pol.	High Flex Leder	7S4FH083510012B20
ABITIG® 20	4 m	ED	BSB 35-50 Rundsteckverbinder 7-pol.	Standard	7S5SK043510012B20
	8 m	ED	BSB 35-50 Rundsteckverbinder 7-pol.	Standard	7S5SK083510012B20
	4 m	ED	BSB 35-50 Rundsteckverbinder 7-pol.	High Flex Leder	7S5SH043510012B20
	8 m	ED	BSB 35-50 Rundsteckverbinder 7-pol.	High Flex Leder	7S5SH083510012B20
ABITIG® 20 Little	4 m	ED	BSB 35-50 Rundsteckverbinder 7-pol.	High Flex Leder	7L5SH043510012B20
	8 m	ED	BSB 35-50 Rundsteckverbinder 7-pol.	High Flex Leder	7L5SH083510012B20
ABITIG® 20F	4 m	ED	BSB 35-50 Rundsteckverbinder 7-pol.	Standard	7S5FK043510012B20
	8 m	ED	BSB 35-50 Rundsteckverbinder 7-pol.	Standard	7S5FK083510012B20
	4 m	ED	BSB 35-50 Rundsteckverbinder 7-pol.	High Flex Leder	7S5FH043510012B20
	8 m	ED	BSB 35-50 Rundsteckverbinder 7-pol.	High Flex Leder	7S5FH083510012B20
ABITIG® 20F Little	4 m	ED	BSB 35-50 Rundsteckverbinder 7-pol.	High Flex Leder	7L5FH043510012B20
	8 m	ED	BSB 35-50 Rundsteckverbinder 7-pol.	High Flex Leder	7L5FH083510012B20

Technische Änderungen vorbehalten • Verkaufspreise = unverbindliche Preisempfehlung - Angebot freibleibend • © Copyright

ABITIG® GRIP / ABITIG® GRIP Little-Brennerpreisliste

passend für WIG-Stromquellen des Fabrikates „bester“

Brennertyp	Länge	Schalterfunktion	maschinenseitiger Anschluss	Schlauchpaketausführung	Bestellnummer
ABITIG® 12-1	4 m	ED	BSB 35-50 Rundsteckverbinder 7-pol.	Standard	7S6SK043510012B20
	8 m	ED	BSB 35-50 Rundsteckverbinder 7-pol.	Standard	7S6SK083510012B20
	4 m	ED	BSB 35-50 Rundsteckverbinder 7-pol.	High Flex Leder	7S6SH043510012B20
	8 m	ED	BSB 35-50 Rundsteckverbinder 7-pol.	High Flex Leder	7S6SH083510012B20
ABITIG® 18SC	4 m	ED	BSB 35-50 Rundsteckverbinder 7-pol.	Standard	7S7SK043510012B20
	8 m	ED	BSB 35-50 Rundsteckverbinder 7-pol.	Standard	7S7SK083510012B20
	4 m	ED	BSB 35-50 Rundsteckverbinder 7-pol.	High Flex Leder	7S7SH043510012B20
	8 m	ED	BSB 35-50 Rundsteckverbinder 7-pol.	High Flex Leder	7S7SH083510012B20
ABITIG® 24W	4 m	ED	BSB 35-50 Rundsteckverbinder 7-pol.	Standard	7S9SK043510012B20
	8 m	ED	BSB 35-50 Rundsteckverbinder 7-pol.	Standard	7S9SK083510012B20
	4 m	ED	BSB 35-50 Rundsteckverbinder 7-pol.	High Flex Leder	7S9SH043510012B20
	8 m	ED	BSB 35-50 Rundsteckverbinder 7-pol.	High Flex Leder	7S9SH083510012B20
ABITIG® 24W Little	4 m	ED	BSB 35-50 Rundsteckverbinder 7-pol.	High Flex Leder	7L9SH043510012B20
	8 m	ED	BSB 35-50 Rundsteckverbinder 7-pol.	High Flex Leder	7L9SH083510012B20
ABITIG® 450W	4 m	ED	BSB 35-50 Rundsteckverbinder 7-pol.	Standard	7T5SK043510112B20
	8 m	ED	BSB 35-50 Rundsteckverbinder 7-pol.	Standard	7T5SK083510112B20
	4 m	ED	BSB 35-50 Rundsteckverbinder 7-pol.	High Flex Leder	7T5SH043510112B20
	8 m	ED	BSB 35-50 Rundsteckverbinder 7-pol.	High Flex Leder	7T5SH083510112B20
ABITIG® 260W	4 m	ED	BSB 35-50 Rundsteckverbinder 7-pol.	Standard	7T7SK043510112B20
	8 m	ED	BSB 35-50 Rundsteckverbinder 7-pol.	Standard	7T7SK083510112B20
	4 m	ED	BSB 35-50 Rundsteckverbinder 7-pol.	High Flex Leder	7T7SH043510112B20
	8 m	ED	BSB 35-50 Rundsteckverbinder 7-pol.	High Flex Leder	7T7SH083510112B20
ABITIG® 260W Little	4 m	ED	BSB 35-50 Rundsteckverbinder 7-pol.	High Flex Leder	7L7SH043510112B20
	8 m	ED	BSB 35-50 Rundsteckverbinder 7-pol.	High Flex Leder	7L7SH083510112B20
ABITIG® 450W SC	4 m	ED	BSB 35-50 Rundsteckverbinder 7-pol.	Standard	
	8 m	ED	BSB 35-50 Rundsteckverbinder 7-pol.	Standard	
	4 m	ED	BSB 35-50 Rundsteckverbinder 7-pol.	High Flex Leder	7T8SH043510112B20
	8 m	ED	BSB 35-50 Rundsteckverbinder 7-pol.	High Flex Leder	7T8SH083510112B20

ABITIG® GRIP / ABITIG® GRIP Little-Brennerpreisliste

passend für WIG-Stromquellen des Fabrikates „castolin“



Brennertyp	Länge	Schalterfunktion	maschinenseitiger Anschluss	Schlauchpaketausführung	Bestellnummer
ABITIG® 9	4 m	DD	ZA - GZ Tuchel 5-pol.	Standard	7S1SK043520301A00
	8 m	DD	ZA - GZ Tuchel 5-pol.	Standard	7S1SK083520301A00
	4 m	DD	ZA - GZ Tuchel 5-pol.	High Flex Leder	7S1SH043520301A00
	8 m	DD	ZA - GZ Tuchel 5-pol.	High Flex Leder	7S1SH083520301A00
ABITIG® 9 Little	4 m	DD	ZA - GZ Tuchel 5-pol.	High Flex Leder	7L1SH043520301A00
	8 m	DD	ZA - GZ Tuchel 5-pol.	High Flex Leder	7L1SH083520301A00
ABITIG® 9F	4 m	DD	ZA - GZ Tuchel 5-pol.	Standard	7S1FK043520301A00
	8 m	DD	ZA - GZ Tuchel 5-pol.	Standard	7S1FK083520301A00
	4 m	DD	ZA - GZ Tuchel 5-pol.	High Flex Leder	7S1FH043520301A00
	8 m	DD	ZA - GZ Tuchel 5-pol.	High Flex Leder	7S1FH083520301A00
ABITIG® 9F Little	4 m	DD	ZA - GZ Tuchel 5-pol.	High Flex Leder	7L1FH043520301A00
	8 m	DD	ZA - GZ Tuchel 5-pol.	High Flex Leder	7L1FH083520301A00
ABITIG® 17	4 m	DD	ZA - GZ Tuchel 5-pol.	Standard	7S2SK043520301A00
	8 m	DD	ZA - GZ Tuchel 5-pol.	Standard	7S2SK083520301A00
	4 m	DD	ZA - GZ Tuchel 5-pol.	High Flex Leder	7S2SH043520301A00
	8 m	DD	ZA - GZ Tuchel 5-pol.	High Flex Leder	7S2SH083520301A00
ABITIG® 17 Little	4 m	DD	ZA - GZ Tuchel 5-pol.	High Flex Leder	7L2SH043520301A00
	8 m	DD	ZA - GZ Tuchel 5-pol.	High Flex Leder	7L2SH083520301A00
ABITIG® 17F	4 m	DD	ZA - GZ Tuchel 5-pol.	Standard	7S2FK043520301A00
	8 m	DD	ZA - GZ Tuchel 5-pol.	Standard	7S2FK083520301A00
	4 m	DD	ZA - GZ Tuchel 5-pol.	High Flex Leder	7S2FH043520301A00
	8 m	DD	ZA - GZ Tuchel 5-pol.	High Flex Leder	7S2FH083520301A00
ABITIG® 17F Little	4 m	DD	ZA - GZ Tuchel 5-pol.	High Flex Leder	7L2FH043520301A00
	8 m	DD	ZA - GZ Tuchel 5-pol.	High Flex Leder	7L2FH083520301A00

Technische Änderungen vorbehalten • Verkaufspreise = unverbindliche Preisempfehlung - Angebot freibleibend • © Copyright

ABITIG® GRIP / ABITIG® GRIP Little-Brennerpreisliste

passend für WIG-Stromquellen des Fabrikates „castolin“

Brennertyp	Länge	Schalterfunktion	maschinenseitiger Anschluss	Schlauchpaketausführung	Bestellnummer
ABITIG® 26	4 m	DD	ZA - GZ Tuchel 5-pol.	Standard	7S3SK043520301A00
	8 m	DD	ZA - GZ Tuchel 5-pol.	Standard	7S3SK083520301A00
	4 m	DD	ZA - GZ Tuchel 5-pol.	High Flex Leder	7S3SH043520301A00
	8 m	DD	ZA - GZ Tuchel 5-pol.	High Flex Leder	7S3SH083520301A00
ABITIG® 26F	4 m	DD	ZA - GZ Tuchel 5-pol.	Standard	7S3FK043520301A00
	8 m	DD	ZA - GZ Tuchel 5-pol.	Standard	7S3FK083520301A00
	4 m	DD	ZA - GZ Tuchel 5-pol.	High Flex Leder	7S3FH043520301A00
	8 m	DD	ZA - GZ Tuchel 5-pol.	High Flex Leder	7S3FH083520301A00
ABITIG® 24G	4 m	DD	ZA - GZ Tuchel 5-pol.	Standard	7S8SK043520301A00
	8 m	DD	ZA - GZ Tuchel 5-pol.	Standard	7S8SK083520301A00
	4 m	DD	ZA - GZ Tuchel 5-pol.	High Flex Leder	7S8SH043520301A00
	8 m	DD	ZA - GZ Tuchel 5-pol.	High Flex Leder	7S8SH083520301A00
ABITIG® 24G Little	4 m	DD	ZA - GZ Tuchel 5-pol.	High Flex Leder	7L8SH043520301A00
	8 m	DD	ZA - GZ Tuchel 5-pol.	High Flex Leder	7L8SH083520301A00
ABITIG® 200	4 m	DD	ZA - GZ Tuchel 5-pol.	Standard	7T4SK043520301A00
	8 m	DD	ZA - GZ Tuchel 5-pol.	Standard	7T4SK083520301A00
	4 m	DD	ZA - GZ Tuchel 5-pol.	High Flex Leder	7T4SH043520301A00
	8 m	DD	ZA - GZ Tuchel 5-pol.	High Flex Leder	7T4SH083520301A00
ABITIG® 200F	4 m	DD	ZA - GZ Tuchel 5-pol.	Standard	7T4FK043520301A00
	8 m	DD	ZA - GZ Tuchel 5-pol.	Standard	7T4FK083520301A00
	4 m	DD	ZA - GZ Tuchel 5-pol.	High Flex Leder	7T4FH043520301A00
	8 m	DD	ZA - GZ Tuchel 5-pol.	High Flex Leder	7T4FH083520301A00
ABITIG® 150	4 m	DD	ZA - GZ Tuchel 5-pol.	Standard	7T6SK043520301A00
	8 m	DD	ZA - GZ Tuchel 5-pol.	Standard	7T6SK083520301A00
	4 m	DD	ZA - GZ Tuchel 5-pol.	High Flex Leder	7T6SH043520301A00
	8 m	DD	ZA - GZ Tuchel 5-pol.	High Flex Leder	7T6SH083520301A00
ABITIG® 150 Little	4 m	DD	ZA - GZ Tuchel 5-pol.	High Flex Leder	7L6SH043520301A00
	8 m	DD	ZA - GZ Tuchel 5-pol.	High Flex Leder	7L6SH083520301A00
ABITIG® 150F	4 m	DD	ZA - GZ Tuchel 5-pol.	Standard	7T6FK043520301A00
	8 m	DD	ZA - GZ Tuchel 5-pol.	Standard	7T6FK083520301A00
	4 m	DD	ZA - GZ Tuchel 5-pol.	High Flex Leder	7T6FH043520301A00
	8 m	DD	ZA - GZ Tuchel 5-pol.	High Flex Leder	7T6FH083520301A00
ABITIG® 150F Little	4 m	DD	ZA - GZ Tuchel 5-pol.	High Flex Leder	7L6FH043520301A00
	8 m	DD	ZA - GZ Tuchel 5-pol.	High Flex Leder	7L6FH083520301A00

ABITIG® GRIP / ABITIG® GRIP Little-Brennerpreisliste

passend für WIG-Stromquellen des Fabrikates „castolin“



Brennertyp	Länge	Schalterfunktion	maschinenseitiger Anschluss	Schlauchpaketausführung	Bestellnummer
ABITIG® 9	4 m	ED	ZA - GZ Tuchel 5-pol.	Standard	7S1SK043510306A00
	8 m	ED	ZA - GZ Tuchel 5-pol.	Standard	7S1SK083510306A00
	4 m	ED	ZA - GZ Tuchel 5-pol.	High Flex Leder	7S1SH043510306A00
	8 m	ED	ZA - GZ Tuchel 5-pol.	High Flex Leder	7S1SH083510306A00
ABITIG® 9 Little	4 m	ED	ZA - GZ Tuchel 5-pol.	High Flex Leder	7L1SH043510306A00
	8 m	ED	ZA - GZ Tuchel 5-pol.	High Flex Leder	7L1SH083510306A00
ABITIG® 9F	4 m	ED	ZA - GZ Tuchel 5-pol.	Standard	7S1FK043510306A00
	8 m	ED	ZA - GZ Tuchel 5-pol.	Standard	7S1FK083510306A00
	4 m	ED	ZA - GZ Tuchel 5-pol.	High Flex Leder	7S1FH043510306A00
	8 m	ED	ZA - GZ Tuchel 5-pol.	High Flex Leder	7S1FH083510306A00
ABITIG® 9F Little	4 m	ED	ZA - GZ Tuchel 5-pol.	High Flex Leder	7L1FH043510306A00
	8 m	ED	ZA - GZ Tuchel 5-pol.	High Flex Leder	7L1FH083510306A00
ABITIG® 17	4 m	ED	ZA - GZ Tuchel 5-pol.	Standard	7S2SK043510306A00
	8 m	ED	ZA - GZ Tuchel 5-pol.	Standard	7S2SK083510306A00
	4 m	ED	ZA - GZ Tuchel 5-pol.	High Flex Leder	7S2SH043510306A00
	8 m	ED	ZA - GZ Tuchel 5-pol.	High Flex Leder	7S2SH083510306A00
ABITIG® 17 Little	4 m	ED	ZA - GZ Tuchel 5-pol.	High Flex Leder	7L2SH043510306A00
	8 m	ED	ZA - GZ Tuchel 5-pol.	High Flex Leder	7L2SH083510306A00
ABITIG® 17F	4 m	ED	ZA - GZ Tuchel 5-pol.	Standard	7S2FK043510306A00
	8 m	ED	ZA - GZ Tuchel 5-pol.	Standard	7S2FK083510306A00
	4 m	ED	ZA - GZ Tuchel 5-pol.	High Flex Leder	7S2FH043510306A00
	8 m	ED	ZA - GZ Tuchel 5-pol.	High Flex Leder	7S2FH083510306A00
ABITIG® 17F Little	4 m	ED	ZA - GZ Tuchel 5-pol.	High Flex Leder	7L2FH043510306A00
	8 m	ED	ZA - GZ Tuchel 5-pol.	High Flex Leder	7L2FH083510306A00

Technische Änderungen vorbehalten • Verkaufspreise = unverbindliche Preisempfehlung - Angebot freibleibend • © Copyright

ABITIG® GRIP / ABITIG® GRIP Little-Brennerpreisliste

passend für WIG-Stromquellen des Fabrikates „castolin“

Brennertyp	Länge	Schalterfunktion	maschinenseitiger Anschluss	Schlauchpaketausführung	Bestellnummer
ABITIG® 26	4 m	ED	ZA - GZ Tuchel 5-pol.	Standard	7S3SK043510306A00
	8 m	ED	ZA - GZ Tuchel 5-pol.	Standard	7S3SK083510306A00
	4 m	ED	ZA - GZ Tuchel 5-pol.	High Flex Leder	7S3SH043510306A00
	8 m	ED	ZA - GZ Tuchel 5-pol.	High Flex Leder	7S3SH083510306A00
ABITIG® 26F	4 m	ED	ZA - GZ Tuchel 5-pol.	Standard	7S3FK043510306A00
	8 m	ED	ZA - GZ Tuchel 5-pol.	Standard	7S3FK083510306A00
	4 m	ED	ZA - GZ Tuchel 5-pol.	High Flex Leder	7S3FH043510306A00
	8 m	ED	ZA - GZ Tuchel 5-pol.	High Flex Leder	7S3FH083510306A00
ABITIG® 24G	4 m	ED	ZA - GZ Tuchel 5-pol.	Standard	7S8SK043510306A00
	8 m	ED	ZA - GZ Tuchel 5-pol.	Standard	7S8SK083510306A00
	4 m	ED	ZA - GZ Tuchel 5-pol.	High Flex Leder	7S8SH043510306A00
	8 m	ED	ZA - GZ Tuchel 5-pol.	High Flex Leder	7S8SH083510306A00
ABITIG® 24G Little	4 m	ED	ZA - GZ Tuchel 5-pol.	High Flex Leder	7L8SH043510306A00
	8 m	ED	ZA - GZ Tuchel 5-pol.	High Flex Leder	7L8SH083510306A00
ABITIG® 200	4 m	ED	ZA - GZ Tuchel 5-pol.	Standard	7T4SK043510306A00
	8 m	ED	ZA - GZ Tuchel 5-pol.	Standard	7T4SK083510306A00
	4 m	ED	ZA - GZ Tuchel 5-pol.	High Flex Leder	7T4SH043510306A00
	8 m	ED	ZA - GZ Tuchel 5-pol.	High Flex Leder	7T4SH083510306A00
ABITIG® 200F	4 m	ED	ZA - GZ Tuchel 5-pol.	Standard	7T4FK043510306A00
	8 m	ED	ZA - GZ Tuchel 5-pol.	Standard	7T4FK083510306A00
	4 m	ED	ZA - GZ Tuchel 5-pol.	High Flex Leder	7T4FH043510306A00
	8 m	ED	ZA - GZ Tuchel 5-pol.	High Flex Leder	7T4FH083510306A00
ABITIG® 150	4 m	ED	ZA - GZ Tuchel 5-pol.	Standard	7T6SK043510306A00
	8 m	ED	ZA - GZ Tuchel 5-pol.	Standard	7T6SK083510306A00
	4 m	ED	ZA - GZ Tuchel 5-pol.	High Flex Leder	7T6SH043510306A00
	8 m	ED	ZA - GZ Tuchel 5-pol.	High Flex Leder	7T6SH083510306A00
ABITIG® 150 Little	4 m	ED	ZA - GZ Tuchel 5-pol.	High Flex Leder	7L6SH043510306A00
	8 m	ED	ZA - GZ Tuchel 5-pol.	High Flex Leder	7L6SH083510306A00
ABITIG® 150F	4 m	ED	ZA - GZ Tuchel 5-pol.	Standard	7T6FK043510306A00
	8 m	ED	ZA - GZ Tuchel 5-pol.	Standard	7T6FK083510306A00
	4 m	ED	ZA - GZ Tuchel 5-pol.	High Flex Leder	7T6FH043510306A00
	8 m	ED	ZA - GZ Tuchel 5-pol.	High Flex Leder	7T6FH083510306A00
ABITIG® 150F Little	4 m	ED	ZA - GZ Tuchel 5-pol.	High Flex Leder	7L6FH043510306A00
	8 m	ED	ZA - GZ Tuchel 5-pol.	High Flex Leder	7L6FH083510306A00

ABITIG® GRIP / ABITIG® GRIP Little-Brennerpreisliste

passend für WIG-Stromquellen des Fabrikates „castolin“



Brennertyp	Länge	Schalterfunktion	maschinenseitiger Anschluss	Schlauchpaketausführung	Bestellnummer
ABITIG® 9	4 m	DD	ZA - GZ Tuchel 7-pol.	Standard	7S1SK043520334A00
	8 m	DD	ZA - GZ Tuchel 7-pol.	Standard	7S1SK083520334A00
	4 m	DD	ZA - GZ Tuchel 7-pol.	High Flex Leder	7S1SH043520334A00
	8 m	DD	ZA - GZ Tuchel 7-pol.	High Flex Leder	7S1SH083520334A00
ABITIG® 9 Little	4 m	DD	ZA - GZ Tuchel 7-pol.	High Flex Leder	7L1SH043520334A00
	8 m	DD	ZA - GZ Tuchel 7-pol.	High Flex Leder	7L1SH083520334A00
ABITIG® 9F	4 m	DD	ZA - GZ Tuchel 7-pol.	Standard	7S1FK043520334A00
	8 m	DD	ZA - GZ Tuchel 7-pol.	Standard	7S1FK083520334A00
	4 m	DD	ZA - GZ Tuchel 7-pol.	High Flex Leder	7S1FH043520334A00
	8 m	DD	ZA - GZ Tuchel 7-pol.	High Flex Leder	7S1FH083520334A00
ABITIG® 9F Little	4 m	DD	ZA - GZ Tuchel 7-pol.	High Flex Leder	7L1FH043520334A00
	8 m	DD	ZA - GZ Tuchel 7-pol.	High Flex Leder	7L1FH083520334A00
ABITIG® 17	4 m	DD	ZA - GZ Tuchel 7-pol.	Standard	7S2SK043520334A00
	8 m	DD	ZA - GZ Tuchel 7-pol.	Standard	7S2SK083520334A00
	4 m	DD	ZA - GZ Tuchel 7-pol.	High Flex Leder	7S2SH043520334A00
	8 m	DD	ZA - GZ Tuchel 7-pol.	High Flex Leder	7S2SH083520334A00
ABITIG® 17 Little	4 m	DD	ZA - GZ Tuchel 7-pol.	High Flex Leder	7L2SH043520334A00
	8 m	DD	ZA - GZ Tuchel 7-pol.	High Flex Leder	7L2SH083520334A00
ABITIG® 17F	4 m	DD	ZA - GZ Tuchel 7-pol.	Standard	7S2FK043520334A00
	8 m	DD	ZA - GZ Tuchel 7-pol.	Standard	7S2FK083520334A00
	4 m	DD	ZA - GZ Tuchel 7-pol.	High Flex Leder	7S2FH043520334A00
	8 m	DD	ZA - GZ Tuchel 7-pol.	High Flex Leder	7S2FH083520334A00
ABITIG® 17F Little	4 m	DD	ZA - GZ Tuchel 7-pol.	High Flex Leder	7L2FH043520334A00
	8 m	DD	ZA - GZ Tuchel 7-pol.	High Flex Leder	7L2FH083520334A00

Technische Änderungen vorbehalten • Verkaufspreise = unverbindliche Preisempfehlung - Angebot freibleibend • © Copyright

ABITIG® GRIP / ABITIG® GRIP Little-Brennerpreisliste

passend für WIG-Stromquellen des Fabrikates „castolin“

Brennertyp	Länge	Schalterfunktion	maschinenseitiger Anschluss	Schlauchpaketausführung	Bestellnummer
ABITIG® 26	4 m	DD	ZA - GZ Tuchel 7-pol.	Standard	7S3SK043520334A00
	8 m	DD	ZA - GZ Tuchel 7-pol.	Standard	7S3SK083520334A00
	4 m	DD	ZA - GZ Tuchel 7-pol.	High Flex Leder	7S3SH043520334A00
	8 m	DD	ZA - GZ Tuchel 7-pol.	High Flex Leder	7S3SH083520334A00
ABITIG® 26F	4 m	DD	ZA - GZ Tuchel 7-pol.	Standard	7S3FK043520334A00
	8 m	DD	ZA - GZ Tuchel 7-pol.	Standard	7S3FK083520334A00
	4 m	DD	ZA - GZ Tuchel 7-pol.	High Flex Leder	7S3FH043520334A00
	8 m	DD	ZA - GZ Tuchel 7-pol.	High Flex Leder	7S3FH083520334A00
ABITIG® 24G	4 m	DD	ZA - GZ Tuchel 7-pol.	Standard	7S8SK043520334A00
	8 m	DD	ZA - GZ Tuchel 7-pol.	Standard	7S8SK083520334A00
	4 m	DD	ZA - GZ Tuchel 7-pol.	High Flex Leder	7S8SH043520334A00
	8 m	DD	ZA - GZ Tuchel 7-pol.	High Flex Leder	7S8SH083520334A00
ABITIG® 24G Little	4 m	DD	ZA - GZ Tuchel 7-pol.	High Flex Leder	7L8SH043520334A00
	8 m	DD	ZA - GZ Tuchel 7-pol.	High Flex Leder	7L8SH083520334A00
ABITIG® 200	4 m	DD	ZA - GZ Tuchel 7-pol.	Standard	7T4SK043520334A00
	8 m	DD	ZA - GZ Tuchel 7-pol.	Standard	7T4SK083520334A00
	4 m	DD	ZA - GZ Tuchel 7-pol.	High Flex Leder	7T4SH043520334A00
	8 m	DD	ZA - GZ Tuchel 7-pol.	High Flex Leder	7T4SH083520334A00
ABITIG® 200F	4 m	DD	ZA - GZ Tuchel 7-pol.	Standard	7T4FK043520334A00
	8 m	DD	ZA - GZ Tuchel 7-pol.	Standard	7T4FK083520334A00
	4 m	DD	ZA - GZ Tuchel 7-pol.	High Flex Leder	7T4FH043520334A00
	8 m	DD	ZA - GZ Tuchel 7-pol.	High Flex Leder	7T4FH083520334A00
ABITIG® 150	4 m	DD	ZA - GZ Tuchel 7-pol.	Standard	7T6SK043520334A00
	8 m	DD	ZA - GZ Tuchel 7-pol.	Standard	7T6SK083520334A00
	4 m	DD	ZA - GZ Tuchel 7-pol.	High Flex Leder	7T6SH043520334A00
	8 m	DD	ZA - GZ Tuchel 7-pol.	High Flex Leder	7T6SH083520334A00
ABITIG® 150 Little	4 m	DD	ZA - GZ Tuchel 7-pol.	High Flex Leder	7L6SH043520334A00
	8 m	DD	ZA - GZ Tuchel 7-pol.	High Flex Leder	7L6SH083520334A00
ABITIG® 150F	4 m	DD	ZA - GZ Tuchel 7-pol.	Standard	7T6FK043520334A00
	8 m	DD	ZA - GZ Tuchel 7-pol.	Standard	7T6FK083520334A00
	4 m	DD	ZA - GZ Tuchel 7-pol.	High Flex Leder	7T6FH043520334A00
	8 m	DD	ZA - GZ Tuchel 7-pol.	High Flex Leder	7T6FH083520334A00
ABITIG® 150F Little	4 m	DD	ZA - GZ Tuchel 7-pol.	High Flex Leder	7L6FH043520334A00
	8 m	DD	ZA - GZ Tuchel 7-pol.	High Flex Leder	7L6FH083520334A00

ABITIG® GRIP / ABITIG® GRIP Little-Brennerpreisliste

passend für WIG-Stromquellen des Fabrikates „castolin“ Up/Down



Brennertyp	Länge	Schalterfunktion	maschinenseitiger Anschluss	Schlauchpaketausführung	Bestellnummer
ABITIG® 9	4 m	UD	ZA - GZ Tuchel 7-pol.	Standard	7S1SK046650318A00
	8 m	UD	ZA - GZ Tuchel 7-pol.	Standard	7S1SK086650318A00
	4 m	UD	ZA - GZ Tuchel 7-pol.	High Flex Leder	7S1SH046650318A00
	8 m	UD	ZA - GZ Tuchel 7-pol.	High Flex Leder	7S1SH086650318A00
ABITIG® 9 Little	4 m	UD	ZA - GZ Tuchel 7-pol.	High Flex Leder	7L1SH046650318A00
	8 m	UD	ZA - GZ Tuchel 7-pol.	High Flex Leder	7L1SH086650318A00
ABITIG® 9F	4 m	UD	ZA - GZ Tuchel 7-pol.	Standard	7S1FK046650318A00
	8 m	UD	ZA - GZ Tuchel 7-pol.	Standard	7S1FK086650318A00
	4 m	UD	ZA - GZ Tuchel 7-pol.	High Flex Leder	7S1FH046650318A00
	8 m	UD	ZA - GZ Tuchel 7-pol.	High Flex Leder	7S1FH086650318A00
ABITIG® 9F Little	4 m	UD	ZA - GZ Tuchel 7-pol.	High Flex Leder	7L1FH046650318A00
	8 m	UD	ZA - GZ Tuchel 7-pol.	High Flex Leder	7L1FH086650318A00
ABITIG® 17	4 m	UD	ZA - GZ Tuchel 7-pol.	Standard	7S2SK046650318A00
	8 m	UD	ZA - GZ Tuchel 7-pol.	Standard	7S2SK086650318A00
	4 m	UD	ZA - GZ Tuchel 7-pol.	High Flex Leder	7S2SH046650318A00
	8 m	UD	ZA - GZ Tuchel 7-pol.	High Flex Leder	7S2SH086650318A00
ABITIG® 17 Little	4 m	UD	ZA - GZ Tuchel 7-pol.	High Flex Leder	7L2SH046650318A00
	8 m	UD	ZA - GZ Tuchel 7-pol.	High Flex Leder	7L2SH086650318A00
ABITIG® 17F	4 m	UD	ZA - GZ Tuchel 7-pol.	Standard	7S2FK046650318A00
	8 m	UD	ZA - GZ Tuchel 7-pol.	Standard	7S2FK086650318A00
	4 m	UD	ZA - GZ Tuchel 7-pol.	High Flex Leder	7S2FH046650318A00
	8 m	UD	ZA - GZ Tuchel 7-pol.	High Flex Leder	7S2FH086650318A00
ABITIG® 17F Little	4 m	UD	ZA - GZ Tuchel 7-pol.	High Flex Leder	7L2FH046650318A00
	8 m	UD	ZA - GZ Tuchel 7-pol.	High Flex Leder	7L2FH086650318A00

Technische Änderungen vorbehalten • Verkaufspreise = unverbindliche Preisempfehlung - Angebot freibleibend • © Copyright

ABITIG® GRIP / ABITIG® GRIP Little-Brennerpreisliste

passend für WIG-Stromquellen des Fabrikates „castolin“ Up/Down

Brennertyp	Länge	Schalterfunktion	maschinenseitiger Anschluss	Schlauchpaketausführung	Bestellnummer
ABITIG® 26	4 m	UD	ZA - GZ Tuchel 7-pol.	Standard	7S3SK046650318A00
	8 m	UD	ZA - GZ Tuchel 7-pol.	Standard	7S3SK086650318A00
	4 m	UD	ZA - GZ Tuchel 7-pol.	High Flex Leder	7S3SH046650318A00
	8 m	UD	ZA - GZ Tuchel 7-pol.	High Flex Leder	7S3SH086650318A00
ABITIG® 26F	4 m	UD	ZA - GZ Tuchel 7-pol.	Standard	7S3FK046650318A00
	8 m	UD	ZA - GZ Tuchel 7-pol.	Standard	7S3FK086650318A00
	4 m	UD	ZA - GZ Tuchel 7-pol.	High Flex Leder	7S3FH046650318A00
	8 m	UD	ZA - GZ Tuchel 7-pol.	High Flex Leder	7S3FH086650318A00
ABITIG® 24G	4 m	UD	ZA - GZ Tuchel 7-pol.	Standard	7S8SK046650318A00
	8 m	UD	ZA - GZ Tuchel 7-pol.	Standard	7S8SK086650318A00
	4 m	UD	ZA - GZ Tuchel 7-pol.	High Flex Leder	7S8SH046650318A00
	8 m	UD	ZA - GZ Tuchel 7-pol.	High Flex Leder	7S8SH086650318A00
ABITIG® 24G Little	4 m	UD	ZA - GZ Tuchel 7-pol.	High Flex Leder	7L8SH046650318A00
	8 m	UD	ZA - GZ Tuchel 7-pol.	High Flex Leder	7L8SH086650318A00
ABITIG® 200	4 m	UD	ZA - GZ Tuchel 7-pol.	Standard	7T4SK046650318A00
	8 m	UD	ZA - GZ Tuchel 7-pol.	Standard	7T4SK086650318A00
	4 m	UD	ZA - GZ Tuchel 7-pol.	High Flex Leder	7T4SH046650318A00
	8 m	UD	ZA - GZ Tuchel 7-pol.	High Flex Leder	7T4SH086650318A00
ABITIG® 200F	4 m	UD	ZA - GZ Tuchel 7-pol.	Standard	7T4FK046650318A00
	8 m	UD	ZA - GZ Tuchel 7-pol.	Standard	7T4FK086650318A00
	4 m	UD	ZA - GZ Tuchel 7-pol.	High Flex Leder	7T4FH046650318A00
	8 m	UD	ZA - GZ Tuchel 7-pol.	High Flex Leder	7T4FH086650318A00
ABITIG® 150	4 m	UD	ZA - GZ Tuchel 7-pol.	Standard	7T6SK046650318A00
	8 m	UD	ZA - GZ Tuchel 7-pol.	Standard	7T6SK086650318A00
	4 m	UD	ZA - GZ Tuchel 7-pol.	High Flex Leder	7T6SH046650318A00
	8 m	UD	ZA - GZ Tuchel 7-pol.	High Flex Leder	7T6SH086650318A00
ABITIG® 150 Little	4 m	UD	ZA - GZ Tuchel 7-pol.	High Flex Leder	7L6SH046650318A00
	8 m	UD	ZA - GZ Tuchel 7-pol.	High Flex Leder	7L6SH086650318A00
ABITIG® 150F	4 m	UD	ZA - GZ Tuchel 7-pol.	Standard	7T6FK046650318A00
	8 m	UD	ZA - GZ Tuchel 7-pol.	Standard	7T6FK086650318A00
	4 m	UD	ZA - GZ Tuchel 7-pol.	High Flex Leder	7T6FH046650318A00
	8 m	UD	ZA - GZ Tuchel 7-pol.	High Flex Leder	7T6FH086650318A00
ABITIG® 150F Little	4 m	UD	ZA - GZ Tuchel 7-pol.	High Flex Leder	7L6FH046650318A00
	8 m	UD	ZA - GZ Tuchel 7-pol.	High Flex Leder	7L6FH086650318A00

ABITIG® GRIP / ABITIG® GRIP Little-Brennerpreisliste

passend für WIG-Stromquellen des Fabrikates „castolin“ Up/Down

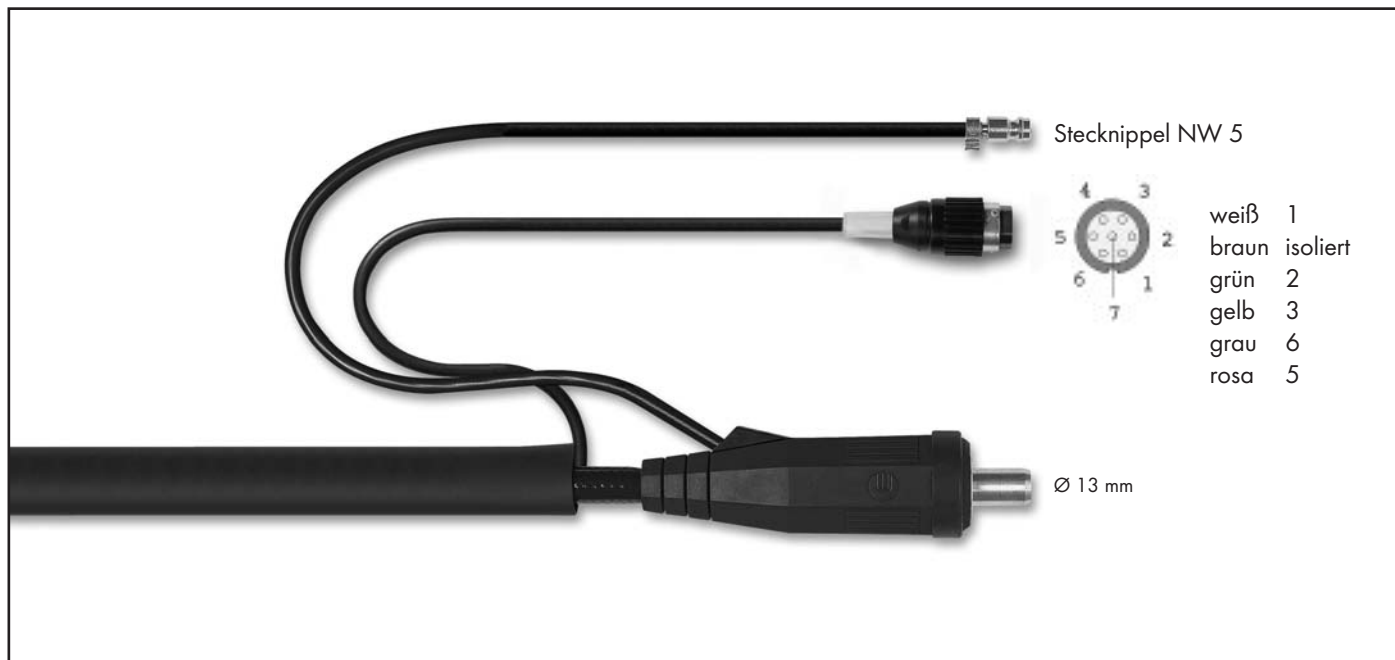

Brennertyp	Länge	Schalterfunktion	maschinenseitiger Anschluss	Schlauchpaketausführung	Bestellnummer
ABITIG® 9	4 m	UD	BSB 35-50 Tuchel 7-pol.	Standard	7S1SK046650018A06
	8 m	UD	BSB 35-50 Tuchel 7-pol.	Standard	7S1SK086650018A06
	4 m	UD	BSB 35-50 Tuchel 7-pol.	High Flex Leder	7S1SH046650018A06
	8 m	UD	BSB 35-50 Tuchel 7-pol.	High Flex Leder	7S1SH086650018A06
ABITIG® 9 Little	4 m	UD	BSB 35-50 Tuchel 7-pol.	High Flex Leder	7L1SH046650018A06
	8 m	UD	BSB 35-50 Tuchel 7-pol.	High Flex Leder	7L1SH086650018A06
ABITIG® 9F	4 m	UD	BSB 35-50 Tuchel 7-pol.	Standard	7S1FK046650018A06
	8 m	UD	BSB 35-50 Tuchel 7-pol.	Standard	7S1FK086650018A06
	4 m	UD	BSB 35-50 Tuchel 7-pol.	High Flex Leder	7S1FH046650018A06
	8 m	UD	BSB 35-50 Tuchel 7-pol.	High Flex Leder	7S1FH086650018A06
ABITIG® 9F Little	4 m	UD	BSB 35-50 Tuchel 7-pol.	High Flex Leder	7L1FH046650018A06
	8 m	UD	BSB 35-50 Tuchel 7-pol.	High Flex Leder	7L1FH086650018A06
ABITIG® 17	4 m	UD	BSB 35-50 Tuchel 7-pol.	Standard	7S2SK046650018A06
	8 m	UD	BSB 35-50 Tuchel 7-pol.	Standard	7S2SK086650018A06
	4 m	UD	BSB 35-50 Tuchel 7-pol.	High Flex Leder	7S2SH046650018A06
	8 m	UD	BSB 35-50 Tuchel 7-pol.	High Flex Leder	7S2SH086650018A06
ABITIG® 17 Little	4 m	UD	BSB 35-50 Tuchel 7-pol.	High Flex Leder	7L2SH046650018A06
	8 m	UD	BSB 35-50 Tuchel 7-pol.	High Flex Leder	7L2SH086650018A06
ABITIG® 17F	4 m	UD	BSB 35-50 Tuchel 7-pol.	Standard	7S2FK046650018A06
	8 m	UD	BSB 35-50 Tuchel 7-pol.	Standard	7S2FK086650018A06
	4 m	UD	BSB 35-50 Tuchel 7-pol.	High Flex Leder	7S2FH046650018A06
	8 m	UD	BSB 35-50 Tuchel 7-pol.	High Flex Leder	7S2FH086650018A06
ABITIG® 17F Little	4 m	UD	BSB 35-50 Tuchel 7-pol.	High Flex Leder	7L2FH046650018A06
	8 m	UD	BSB 35-50 Tuchel 7-pol.	High Flex Leder	7L2FH086650018A06

Technische Änderungen vorbehalten • Verkaufspreise = unverbindliche Preisempfehlung - Angebot freibleibend • © Copyright

ABITIG® GRIP / ABITIG® GRIP Little-Brennerpreisliste

passend für WIG-Stromquellen des Fabrikates „castolin“ Up/Down

Brennertyp	Länge	Schalterfunktion	maschinenseitiger Anschluss	Schlauchpaketausführung	Bestellnummer
ABITIG® 26	4 m	UD	BSB 35-50 Tuchel 7-pol.	Standard	7S3SK046650018A06
	8 m	UD	BSB 35-50 Tuchel 7-pol.	Standard	7S3SK086650018A06
	4 m	UD	BSB 35-50 Tuchel 7-pol.	High Flex Leder	7S3SH046650018A06
	8 m	UD	BSB 35-50 Tuchel 7-pol.	High Flex Leder	7S3SH086650018A06
ABITIG® 26F	4 m	UD	BSB 35-50 Tuchel 7-pol.	Standard	7S3FK046650018A06
	8 m	UD	BSB 35-50 Tuchel 7-pol.	Standard	7S3FK086650018A06
	4 m	UD	BSB 35-50 Tuchel 7-pol.	High Flex Leder	7S3FH046650018A06
	8 m	UD	BSB 35-50 Tuchel 7-pol.	High Flex Leder	7S3FH086650018A06
ABITIG® 24G	4 m	UD	BSB 35-50 Tuchel 7-pol.	Standard	7S8SK046650018A06
	8 m	UD	BSB 35-50 Tuchel 7-pol.	Standard	7S8SK086650018A06
	4 m	UD	BSB 35-50 Tuchel 7-pol.	High Flex Leder	7S8SH046650018A06
	8 m	UD	BSB 35-50 Tuchel 7-pol.	High Flex Leder	7S8SH086650018A06
ABITIG® 24G Little	4 m	UD	BSB 35-50 Tuchel 7-pol.	High Flex Leder	7L8SH046650018A06
	8 m	UD	BSB 35-50 Tuchel 7-pol.	High Flex Leder	7L8SH086650018A06
ABITIG® 200	4 m	UD	BSB 35-50 Tuchel 7-pol.	Standard	7T4SK046650018A06
	8 m	UD	BSB 35-50 Tuchel 7-pol.	Standard	7T4SK086650018A06
	4 m	UD	BSB 35-50 Tuchel 7-pol.	High Flex Leder	7T4SH046650018A06
	8 m	UD	BSB 35-50 Tuchel 7-pol.	High Flex Leder	7T4SH086650018A06
ABITIG® 200F	4 m	UD	BSB 35-50 Tuchel 7-pol.	Standard	7T4FK046650018A06
	8 m	UD	BSB 35-50 Tuchel 7-pol.	Standard	7T4FK086650018A06
	4 m	UD	BSB 35-50 Tuchel 7-pol.	High Flex Leder	7T4FH046650018A06
	8 m	UD	BSB 35-50 Tuchel 7-pol.	High Flex Leder	7T4FH086650018A06
ABITIG® 150	4 m	UD	BSB 35-50 Tuchel 7-pol.	Standard	7T6SK046650018A06
	8 m	UD	BSB 35-50 Tuchel 7-pol.	Standard	7T6SK086650018A06
	4 m	UD	BSB 35-50 Tuchel 7-pol.	High Flex Leder	7T6SH046650018A06
	8 m	UD	BSB 35-50 Tuchel 7-pol.	High Flex Leder	7T6SH086650018A06
ABITIG® 150 Little	4 m	UD	BSB 35-50 Tuchel 7-pol.	High Flex Leder	7L6SH046650018A06
	8 m	UD	BSB 35-50 Tuchel 7-pol.	High Flex Leder	7L6SH086650018A06
ABITIG® 150F	4 m	UD	BSB 35-50 Tuchel 7-pol.	Standard	7T6FK046650018A06
	8 m	UD	BSB 35-50 Tuchel 7-pol.	Standard	7T6FK086650018A06
	4 m	UD	BSB 35-50 Tuchel 7-pol.	High Flex Leder	7T6FH046650018A06
	8 m	UD	BSB 35-50 Tuchel 7-pol.	High Flex Leder	7T6FH086650018A06
ABITIG® 150F Little	4 m	UD	BSB 35-50 Tuchel 7-pol.	High Flex Leder	7L6FH046650018A06
	8 m	UD	BSB 35-50 Tuchel 7-pol.	High Flex Leder	7L6FH086650018A06

ABITIG® GRIP / ABITIG® GRIP Little-Brennerpreisliste

passend für WIG-Stromquellen des Fabrikates „castolin“



Brennertyp	Länge	Schalterfunktion	maschinenseitiger Anschluss	Schlauchpaketausführung	Bestellnummer
ABITIG® 9	4 m	ED	MAG - ZA	Standard	7S1SK043513496A00
	8 m	ED	MAG - ZA	Standard	7S1SK083513496A00
	4 m	ED	MAG - ZA	High Flex Leder	7S1SH043513496A00
	8 m	ED	MAG - ZA	High Flex Leder	7S1SH083513496A00
ABITIG® 9 Little	4 m	ED	MAG - ZA	High Flex Leder	7L1SH043513496A00
	8 m	ED	MAG - ZA	High Flex Leder	7L1SH083513496A00
ABITIG® 9F	4 m	ED	MAG - ZA	Standard	7S1FK043513496A00
	8 m	ED	MAG - ZA	Standard	7S1FK083513496A00
	4 m	ED	MAG - ZA	High Flex Leder	7S1FH043513496A00
	8 m	ED	MAG - ZA	High Flex Leder	7S1FH083513496A00
ABITIG® 9F Little	4 m	ED	MAG - ZA	High Flex Leder	7L1FH043513496A00
	8 m	ED	MAG - ZA	High Flex Leder	7L1FH083513496A00
ABITIG® 17	4 m	ED	MAG - ZA	Standard	7S2SK043513496A00
	8 m	ED	MAG - ZA	Standard	7S2SK083513496A00
	4 m	ED	MAG - ZA	High Flex Leder	7S2SH043513496A00
	8 m	ED	MAG - ZA	High Flex Leder	7S2SH083513496A00
ABITIG® 17 Little	4 m	ED	MAG - ZA	High Flex Leder	7L2SH043513496A00
	8 m	ED	MAG - ZA	High Flex Leder	7L2SH083513496A00
ABITIG® 17F	4 m	ED	MAG - ZA	Standard	7S2FK043513496A00
	8 m	ED	MAG - ZA	Standard	7S2FK083513496A00
	4 m	ED	MAG - ZA	High Flex Leder	7S2FH043513496A00
	8 m	ED	MAG - ZA	High Flex Leder	7S2FH083513496A00
ABITIG® 17F Little	4 m	ED	MAG - ZA	High Flex Leder	7L2FH043513496A00
	8 m	ED	MAG - ZA	High Flex Leder	7L2FH083513496A00

Technische Änderungen vorbehalten • Verkaufspreise = unverbindliche Preisempfehlung - Angebot freibleibend • © Copyright

ABITIG® GRIP / ABITIG® GRIP Little-Brennerpreisliste

passend für WIG-Stromquellen des Fabrikates „castolin“

Brennertyp	Länge	Schalterfunktion	maschinenseitiger Anschluss	Schlauchpaketausführung	Bestellnummer
ABITIG® 26	4 m	ED	MAG - ZA	Standard	7S3SK043513496A00
	8 m	ED	MAG - ZA	Standard	7S3SK083513496A00
	4 m	ED	MAG - ZA	High Flex Leder	7S3SH043513496A00
	8 m	ED	MAG - ZA	High Flex Leder	7S3SH083513496A00
ABITIG® 26F	4 m	ED	MAG - ZA	Standard	7S3FK043513496A00
	8 m	ED	MAG - ZA	Standard	7S3FK083513496A00
	4 m	ED	MAG - ZA	High Flex Leder	7S3FH043513496A00
	8 m	ED	MAG - ZA	High Flex Leder	7S3FH083513496A00
ABITIG® 24G	4 m	ED	MAG - ZA	Standard	7S8SK043513496A00
	8 m	ED	MAG - ZA	Standard	7S8SK083513496A00
	4 m	ED	MAG - ZA	High Flex Leder	7S8SH043513496A00
	8 m	ED	MAG - ZA	High Flex Leder	7S8SH083513496A00
ABITIG® 24G Little	4 m	ED	MAG - ZA	High Flex Leder	7L8SH043513496A00
	8 m	ED	MAG - ZA	High Flex Leder	7L8SH083513496A00
ABITIG® 200	4 m	ED	MAG - ZA	Standard	7T4SK043513496A00
	8 m	ED	MAG - ZA	Standard	7T4SK083513496A00
	4 m	ED	MAG - ZA	High Flex Leder	7T4SH043513496A00
	8 m	ED	MAG - ZA	High Flex Leder	7T4SH083513496A00
ABITIG® 200F	4 m	ED	MAG - ZA	Standard	7T4FK043513496A00
	8 m	ED	MAG - ZA	Standard	7T4FK083513496A00
	4 m	ED	MAG - ZA	High Flex Leder	7T4FH043513496A00
	8 m	ED	MAG - ZA	High Flex Leder	7T4FH083513496A00
ABITIG® 150	4 m	ED	MAG - ZA	Standard	7T6SK043513496A00
	8 m	ED	MAG - ZA	Standard	7T6SK083513496A00
	4 m	ED	MAG - ZA	High Flex Leder	7T6SH043513496A00
	8 m	ED	MAG - ZA	High Flex Leder	7T6SH083513496A00
ABITIG® 150 Little	4 m	ED	MAG - ZA	High Flex Leder	7L6SH043513496A00
	8 m	ED	MAG - ZA	High Flex Leder	7L6SH083513496A00
ABITIG® 150F	4 m	ED	MAG - ZA	Standard	7T6FK043513496A00
	8 m	ED	MAG - ZA	Standard	7T6FK083513496A00
	4 m	ED	MAG - ZA	High Flex Leder	7T6FH043513496A00
	8 m	ED	MAG - ZA	High Flex Leder	7T6FH083513496A00
ABITIG® 150F Little	4 m	ED	MAG - ZA	High Flex Leder	7L6FH043513496A00
	8 m	ED	MAG - ZA	High Flex Leder	7L6FH083513496A00

ABITIG® GRIP / ABITIG® GRIP Little-Brennerpreisliste

passend für WIG-Stromquellen des Fabrikates „castolin“



Brennertyp	Länge	Schalterfunktion	maschinenseitiger Anschluss	Schlauchpaketausführung	Bestellnummer
ABITIG® 18	4 m	DD	ZA - WZ-0 Tuchel 5-pol.	Standard	7S4SK043520302C12
	8 m	DD	ZA - WZ-0 Tuchel 5-pol.	Standard	7S4SK083520302C12
	4 m	DD	ZA - WZ-0 Tuchel 5-pol.	High Flex Leder	7S4SH043520302C12
	8 m	DD	ZA - WZ-0 Tuchel 5-pol.	High Flex Leder	7S4SH083520302C12
ABITIG® 18F	4 m	DD	ZA - WZ-0 Tuchel 5-pol.	Standard	7S4FK043520302C12
	8 m	DD	ZA - WZ-0 Tuchel 5-pol.	Standard	7S4FK083520302C12
	4 m	DD	ZA - WZ-0 Tuchel 5-pol.	High Flex Leder	7S4FH043520302C12
	8 m	DD	ZA - WZ-0 Tuchel 5-pol.	High Flex Leder	7S4FH083520302C12
ABITIG® 20	4 m	DD	ZA - WZ-0 Tuchel 5-pol.	Standard	7S5SK043520302C12
	8 m	DD	ZA - WZ-0 Tuchel 5-pol.	Standard	7S5SK083520302C12
	4 m	DD	ZA - WZ-0 Tuchel 5-pol.	High Flex Leder	7S5SH043520302C12
	8 m	DD	ZA - WZ-0 Tuchel 5-pol.	High Flex Leder	7S5SH083520302C12
ABITIG® 20 Little	4 m	DD	ZA - WZ-0 Tuchel 5-pol.	High Flex Leder	7L5SH043520302C12
	8 m	DD	ZA - WZ-0 Tuchel 5-pol.	High Flex Leder	7L5SH083520302C12
ABITIG® 20F	4 m	DD	ZA - WZ-0 Tuchel 5-pol.	Standard	7S5FK043520302C12
	8 m	DD	ZA - WZ-0 Tuchel 5-pol.	Standard	7S5FK083520302C12
	4 m	DD	ZA - WZ-0 Tuchel 5-pol.	High Flex Leder	7S5FH043520302C12
	8 m	DD	ZA - WZ-0 Tuchel 5-pol.	High Flex Leder	7S5FH083520302C12
ABITIG® 20F Little	4 m	DD	ZA - WZ-0 Tuchel 5-pol.	High Flex Leder	7L5FH043520302C12
	8 m	DD	ZA - WZ-0 Tuchel 5-pol.	High Flex Leder	7L5FH083520302C12

Technische Änderungen vorbehalten • Verkaufspreise = unverbindliche Preisempfehlung - Angebot freibleibend • © Copyright

ABITIG® GRIP / ABITIG® GRIP Little-Brennerpreisliste

passend für WIG-Stromquellen des Fabrikates „castolin“

Brennertyp	Länge	Schalterfunktion	maschinenseitiger Anschluss	Schlauchpaketausführung	Bestellnummer
ABITIG® 12-1	4 m	DD	ZA - WZ-0 Tuchel 5-pol.	Standard	7S6SK043520302C12
	8 m	DD	ZA - WZ-0 Tuchel 5-pol.	Standard	7S6SK083520302C12
	4 m	DD	ZA - WZ-0 Tuchel 5-pol.	High Flex Leder	7S6SH043520302C12
	8 m	DD	ZA - WZ-0 Tuchel 5-pol.	High Flex Leder	7S6SH083520302C12
<hr/>					
ABITIG® 18SC	4 m	DD	ZA - WZ-0 Tuchel 5-pol.	Standard	7S7SK043520302C12
	8 m	DD	ZA - WZ-0 Tuchel 5-pol.	Standard	7S7SK083520302C12
	4 m	DD	ZA - WZ-0 Tuchel 5-pol.	High Flex Leder	7S7SH043520302C12
	8 m	DD	ZA - WZ-0 Tuchel 5-pol.	High Flex Leder	7S7SH083520302C12
<hr/>					
ABITIG® 24W	4 m	DD	ZA - WZ-0 Tuchel 5-pol.	Standard	7S9SK043520302C12
	8 m	DD	ZA - WZ-0 Tuchel 5-pol.	Standard	7S9SK083520302C12
	4 m	DD	ZA - WZ-0 Tuchel 5-pol.	High Flex Leder	7S9SH043520302C12
	8 m	DD	ZA - WZ-0 Tuchel 5-pol.	High Flex Leder	7S9SH083520302C12
ABITIG® 24W Little	4 m	DD	ZA - WZ-0 Tuchel 5-pol.	High Flex Leder	7L9SH043520302C12
	8 m	DD	ZA - WZ-0 Tuchel 5-pol.	High Flex Leder	7L9SH083520302C12
<hr/>					
ABITIG® 450W	4 m	DD	ZA - WZ-0 Tuchel 5-pol.	Standard	7T5SK043520302C12
	8 m	DD	ZA - WZ-0 Tuchel 5-pol.	Standard	7T5SK083520302C12
	4 m	DD	ZA - WZ-0 Tuchel 5-pol.	High Flex Leder	7T5SH043520302C12
	8 m	DD	ZA - WZ-0 Tuchel 5-pol.	High Flex Leder	7T5SH083520302C12
<hr/>					
ABITIG® 260W	4 m	DD	ZA - WZ-0 Tuchel 5-pol.	Standard	7T7SK043520302C12
	8 m	DD	ZA - WZ-0 Tuchel 5-pol.	Standard	7T7SK083520302C12
	4 m	DD	ZA - WZ-0 Tuchel 5-pol.	High Flex Leder	7T7SH043520302C12
	8 m	DD	ZA - WZ-0 Tuchel 5-pol.	High Flex Leder	7T7SH083520302C12
ABITIG® 260W Little	4 m	DD	ZA - WZ-0 Tuchel 5-pol.	High Flex Leder	7L7SH043520302C12
	8 m	DD	ZA - WZ-0 Tuchel 5-pol.	High Flex Leder	7L7SH083520302C12
<hr/>					
ABITIG® 450W SC	4 m	DD	ZA - WZ-0 Tuchel 5-pol.	Standard	
	8 m	DD	ZA - WZ-0 Tuchel 5-pol.	Standard	
	4 m	DD	ZA - WZ-0 Tuchel 5-pol.	High Flex Leder	7T8SH043520302C12
	8 m	DD	ZA - WZ-0 Tuchel 5-pol.	High Flex Leder	7T8SH083520302C12

ABITIG® GRIP / ABITIG® GRIP Little-Brennerpreisliste

passend für WIG-Stromquellen des Fabrikates „castolin“



Brennertyp	Länge	Schalterfunktion	maschinenseitiger Anschluss	Schlauchpaketausführung	Bestellnummer
ABITIG® 18	4 m	DD	ZA - WZ-0 Tuchel 7-pol.	Standard	7S4SK043520334A12
	8 m	DD	ZA - WZ-0 Tuchel 7-pol.	Standard	7S4SK083520334A12
	4 m	DD	ZA - WZ-0 Tuchel 7-pol.	High Flex Leder	7S4SH043520334A12
	8 m	DD	ZA - WZ-0 Tuchel 7-pol.	High Flex Leder	7S4SH083520334A12
ABITIG® 18F	4 m	DD	ZA - WZ-0 Tuchel 7-pol.	Standard	7S4FK043520334A12
	8 m	DD	ZA - WZ-0 Tuchel 7-pol.	Standard	7S4FK083520334A12
	4 m	DD	ZA - WZ-0 Tuchel 7-pol.	High Flex Leder	7S4FH043520334A12
	8 m	DD	ZA - WZ-0 Tuchel 7-pol.	High Flex Leder	7S4FH083520334A12
ABITIG® 20	4 m	DD	ZA - WZ-0 Tuchel 7-pol.	Standard	7S5SK043520334A12
	8 m	DD	ZA - WZ-0 Tuchel 7-pol.	Standard	7S5SK083520334A12
	4 m	DD	ZA - WZ-0 Tuchel 7-pol.	High Flex Leder	7S5SH043520334A12
	8 m	DD	ZA - WZ-0 Tuchel 7-pol.	High Flex Leder	7S5SH083520334A12
ABITIG® 20 Little	4 m	DD	ZA - WZ-0 Tuchel 7-pol.	High Flex Leder	7L5SH043520334A12
	8 m	DD	ZA - WZ-0 Tuchel 7-pol.	High Flex Leder	7L5SH083520334A12
ABITIG® 20F	4 m	DD	ZA - WZ-0 Tuchel 7-pol.	Standard	7S5FK043520334A12
	8 m	DD	ZA - WZ-0 Tuchel 7-pol.	Standard	7S5FK083520334A12
	4 m	DD	ZA - WZ-0 Tuchel 7-pol.	High Flex Leder	7S5FH043520334A12
	8 m	DD	ZA - WZ-0 Tuchel 7-pol.	High Flex Leder	7S5FH083520334A12
ABITIG® 20F Little	4 m	DD	ZA - WZ-0 Tuchel 7-pol.	High Flex Leder	7L5FH043520334A12
	8 m	DD	ZA - WZ-0 Tuchel 7-pol.	High Flex Leder	7L5FH083520334A12

Technische Änderungen vorbehalten • Verkaufspreise = unverbindliche Preisempfehlung - Angebot freibleibend • © Copyright

ABITIG® GRIP / ABITIG® GRIP Little-Brennerpreisliste

passend für WIG-Stromquellen des Fabrikates „castolin“

Brennertyp	Länge	Schalterfunktion	maschinenseitiger Anschluss	Schlauchpaketausführung	Bestellnummer
ABITIG® 12-1	4 m	DD	ZA - WZ-0 Tuchel 7-pol.	Standard	7S6SK043520334A12
	8 m	DD	ZA - WZ-0 Tuchel 7-pol.	Standard	7S6SK083520334A12
	4 m	DD	ZA - WZ-0 Tuchel 7-pol.	High Flex Leder	7S6SH043520334A12
	8 m	DD	ZA - WZ-0 Tuchel 7-pol.	High Flex Leder	7S6SH083520334A12
ABITIG® 18SC	4 m	DD	ZA - WZ-0 Tuchel 7-pol.	Standard	7S7SK043520334A12
	8 m	DD	ZA - WZ-0 Tuchel 7-pol.	Standard	7S7SK083520334A12
	4 m	DD	ZA - WZ-0 Tuchel 7-pol.	High Flex Leder	7S7SH043520334A12
	8 m	DD	ZA - WZ-0 Tuchel 7-pol.	High Flex Leder	7S7SH083520334A12
ABITIG® 24W	4 m	DD	ZA - WZ-0 Tuchel 7-pol.	Standard	7S9SK043520334A12
	8 m	DD	ZA - WZ-0 Tuchel 7-pol.	Standard	7S9SK083520334A12
	4 m	DD	ZA - WZ-0 Tuchel 7-pol.	High Flex Leder	7S9SH043520334A12
	8 m	DD	ZA - WZ-0 Tuchel 7-pol.	High Flex Leder	7S9SH083520334A12
ABITIG® 24W Little	4 m	DD	ZA - WZ-0 Tuchel 7-pol.	High Flex Leder	7L9SH043520334A12
	8 m	DD	ZA - WZ-0 Tuchel 7-pol.	High Flex Leder	7L9SH083520334A12
ABITIG® 450W	4 m	DD	ZA - WZ-0 Tuchel 7-pol.	Standard	7T5SK043520334A12
	8 m	DD	ZA - WZ-0 Tuchel 7-pol.	Standard	7T5SK083520334A12
	4 m	DD	ZA - WZ-0 Tuchel 7-pol.	High Flex Leder	7T5SH043520334A12
	8 m	DD	ZA - WZ-0 Tuchel 7-pol.	High Flex Leder	7T5SH083520334A12
ABITIG® 260W	4 m	DD	ZA - WZ-0 Tuchel 7-pol.	Standard	7T7SK043520334A12
	8 m	DD	ZA - WZ-0 Tuchel 7-pol.	Standard	7T7SK083520334A12
	4 m	DD	ZA - WZ-0 Tuchel 7-pol.	High Flex Leder	7T7SH043520334A12
	8 m	DD	ZA - WZ-0 Tuchel 7-pol.	High Flex Leder	7T7SH083520334A12
ABITIG® 450W SC	4 m	DD	ZA - WZ-0 Tuchel 7-pol.	Standard	
	8 m	DD	ZA - WZ-0 Tuchel 7-pol.	Standard	
	4 m	DD	ZA - WZ-0 Tuchel 7-pol.	High Flex Leder	7T8SH043520334A12
	8 m	DD	ZA - WZ-0 Tuchel 7-pol.	High Flex Leder	7T8SH083520334A12

ABITIG® GRIP / ABITIG® GRIP Little-Brennerpreisliste

passend für WIG-Stromquellen des Fabrikates „castolin“ Up/Down

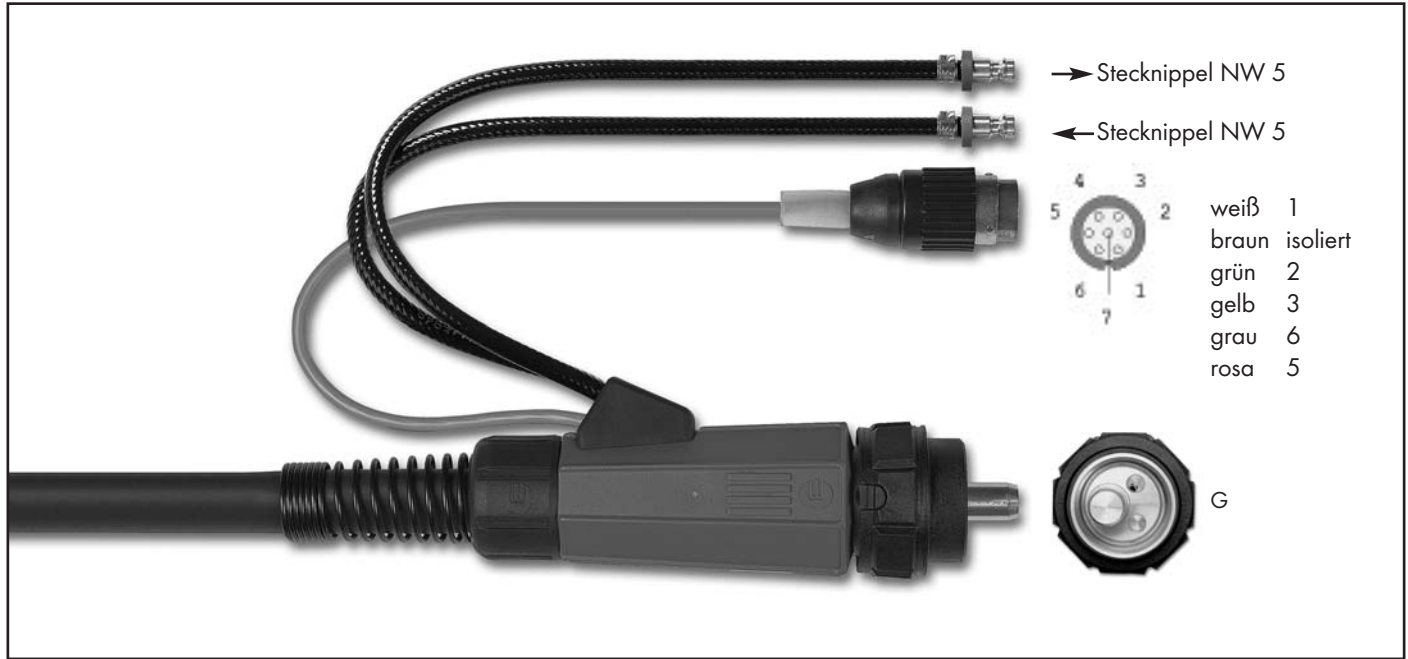

Brennertyp	Länge	Schalterfunktion	maschinenseitiger Anschluss	Schlauchpaketausführung	Bestellnummer
ABITIG® 18	4 m	UD	ZA - WZ-0 Tuchel 7-pol.	Standard	7S4SK046650318A12
	8 m	UD	ZA - WZ-0 Tuchel 7-pol.	Standard	7S4SK086650318A12
	4 m	UD	ZA - WZ-0 Tuchel 7-pol.	High Flex Leder	7S4SH046650318A12
	8 m	UD	ZA - WZ-0 Tuchel 7-pol.	High Flex Leder	7S4SH086650318A12
ABITIG® 18F	4 m	UD	ZA - WZ-0 Tuchel 7-pol.	Standard	7S4FK046650318A12
	8 m	UD	ZA - WZ-0 Tuchel 7-pol.	Standard	7S4FK086650318A12
	4 m	UD	ZA - WZ-0 Tuchel 7-pol.	High Flex Leder	7S4FH046650318A12
	8 m	UD	ZA - WZ-0 Tuchel 7-pol.	High Flex Leder	7S4FH086650318A12
ABITIG® 20	4 m	UD	ZA - WZ-0 Tuchel 7-pol.	Standard	7S5SK046650318A12
	8 m	UD	ZA - WZ-0 Tuchel 7-pol.	Standard	7S5SK086650318A12
	4 m	UD	ZA - WZ-0 Tuchel 7-pol.	High Flex Leder	7S5SH046650318A12
	8 m	UD	ZA - WZ-0 Tuchel 7-pol.	High Flex Leder	7S5SH086650318A12
ABITIG® 20 Little	4 m	UD	ZA - WZ-0 Tuchel 7-pol.	High Flex Leder	7L5SH046650318A12
	8 m	UD	ZA - WZ-0 Tuchel 7-pol.	High Flex Leder	7L5SH086650318A12
ABITIG® 20F	4 m	UD	ZA - WZ-0 Tuchel 7-pol.	Standard	7S5FK046650318A12
	8 m	UD	ZA - WZ-0 Tuchel 7-pol.	Standard	7S5FK086650318A12
	4 m	UD	ZA - WZ-0 Tuchel 7-pol.	High Flex Leder	7S5FH046650318A12
	8 m	UD	ZA - WZ-0 Tuchel 7-pol.	High Flex Leder	7S5FH086650318A12
ABITIG® 20F Little	4 m	UD	ZA - WZ-0 Tuchel 7-pol.	High Flex Leder	7L5FH046650318A12
	8 m	UD	ZA - WZ-0 Tuchel 7-pol.	High Flex Leder	7L5FH086650318A12

Technische Änderungen vorbehalten • Verkaufspreise = unverbindliche Preisempfehlung - Angebot freibleibend • © Copyright

ABITIG® GRIP / ABITIG® GRIP Little-Brennerpreisliste

passend für WIG-Stromquellen des Fabrikates „castolin“ Up/Down

Brennertyp	Länge	Schalterfunktion	maschinenseitiger Anschluss	Schlauchpaketausführung	Bestellnummer
ABITIG® 12-1	4 m	UD	ZA - WZ-0 Tuchel 7-pol.	Standard	7S6SK046650318A12
	8 m	UD	ZA - WZ-0 Tuchel 7-pol.	Standard	7S6SK086650318A12
	4 m	UD	ZA - WZ-0 Tuchel 7-pol.	High Flex Leder	7S6SH046650318A12
	8 m	UD	ZA - WZ-0 Tuchel 7-pol.	High Flex Leder	7S6SH086650318A12
<hr/>					
ABITIG® 18SC	4 m	UD	ZA - WZ-0 Tuchel 7-pol.	Standard	7S7SK046650318A12
	8 m	UD	ZA - WZ-0 Tuchel 7-pol.	Standard	7S7SK086650318A12
	4 m	UD	ZA - WZ-0 Tuchel 7-pol.	High Flex Leder	7S7SH046650318A12
	8 m	UD	ZA - WZ-0 Tuchel 7-pol.	High Flex Leder	7S7SH086650318A12
<hr/>					
ABITIG® 24W	4 m	UD	ZA - WZ-0 Tuchel 7-pol.	Standard	7S9SK046650318A12
	8 m	UD	ZA - WZ-0 Tuchel 7-pol.	Standard	7S9SK086650318A12
	4 m	UD	ZA - WZ-0 Tuchel 7-pol.	High Flex Leder	7S9SH046650318A12
	8 m	UD	ZA - WZ-0 Tuchel 7-pol.	High Flex Leder	7S9SH086650318A12
ABITIG® 24W Little	4 m	UD	ZA - WZ-0 Tuchel 7-pol.	High Flex Leder	7L9SH046650318A12
	8 m	UD	ZA - WZ-0 Tuchel 7-pol.	High Flex Leder	7L9SH086650318A12
<hr/>					
ABITIG® 450W	4 m	UD	ZA - WZ-0 Tuchel 7-pol.	Standard	7T5SK046650318A12
	8 m	UD	ZA - WZ-0 Tuchel 7-pol.	Standard	7T5SK086650318A12
	4 m	UD	ZA - WZ-0 Tuchel 7-pol.	High Flex Leder	7T5SH046650318A12
	8 m	UD	ZA - WZ-0 Tuchel 7-pol.	High Flex Leder	7T5SH086650318A12
<hr/>					
ABITIG® 260W	4 m	UD	ZA - WZ-0 Tuchel 7-pol.	Standard	7T7SK046650318A12
	8 m	UD	ZA - WZ-0 Tuchel 7-pol.	Standard	7T7SK086650318A12
	4 m	UD	ZA - WZ-0 Tuchel 7-pol.	High Flex Leder	7T7SH046650318A12
	8 m	UD	ZA - WZ-0 Tuchel 7-pol.	High Flex Leder	7T7SH086650318A12
ABITIG® 260W Little	4 m	UD	ZA - WZ-0 Tuchel 7-pol.	High Flex Leder	7L7SH046650318A12
	8 m	UD	ZA - WZ-0 Tuchel 7-pol.	High Flex Leder	7L7SH086650318A12
<hr/>					
ABITIG® 450W SC	4 m	UD	ZA - WZ-0 Tuchel 7-pol.	Standard	
	8 m	UD	ZA - WZ-0 Tuchel 7-pol.	Standard	
	4 m	UD	ZA - WZ-0 Tuchel 7-pol.	High Flex Leder	7T8SH046650318A12
	8 m	UD	ZA - WZ-0 Tuchel 7-pol.	High Flex Leder	7T8SH086650318A12

ABITIG® GRIP / ABITIG® GRIP Little-Brennerpreisliste

passend für WIG-Stromquellen des Fabrikates „castolin“

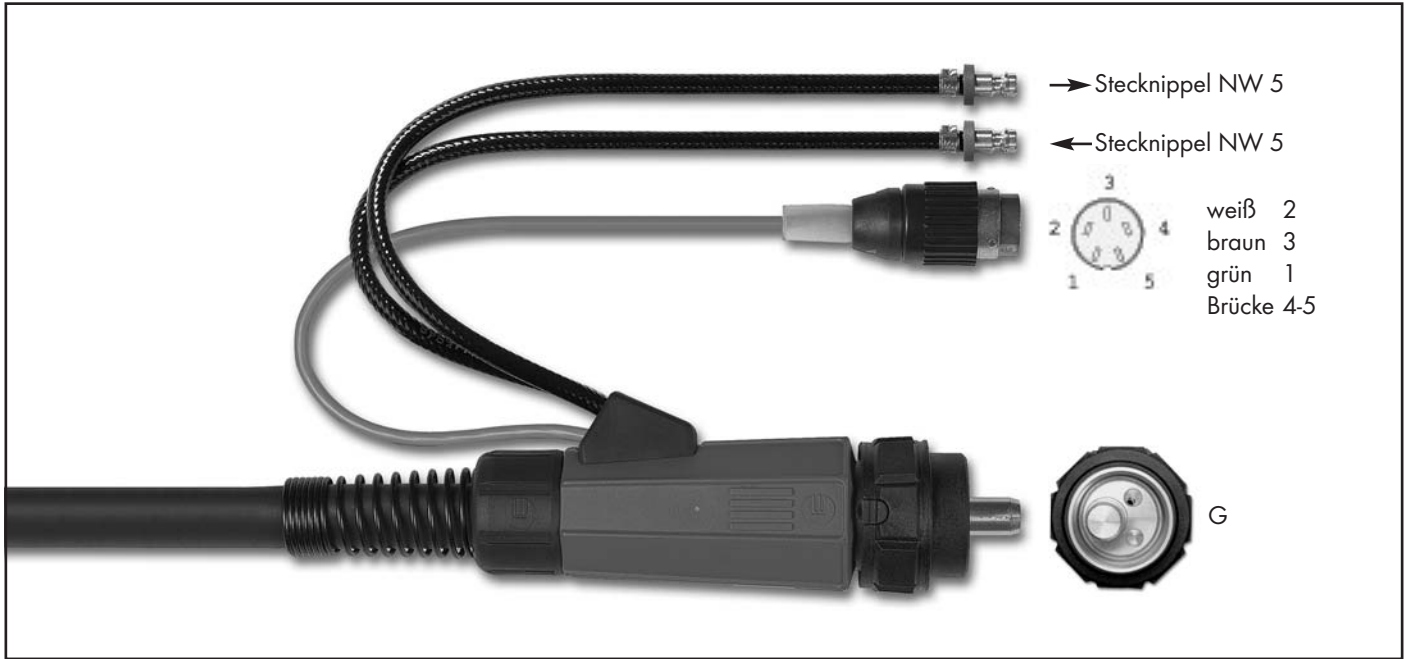

Brennertyp	Länge	Schalterfunktion	maschinenseitiger Anschluss	Schlauchpaketausführung	Bestellnummer
ABITIG® 18	4 m	ED	ZA - WZ-0 Tuchel 5-pol.	Standard	7S4SK043510302A12
	8 m	ED	ZA - WZ-0 Tuchel 5-pol.	Standard	7S4SK083510302A12
	4 m	ED	ZA - WZ-0 Tuchel 5-pol.	High Flex Leder	7S4SH043510302A12
	8 m	ED	ZA - WZ-0 Tuchel 5-pol.	High Flex Leder	7S4SH083510302A12
ABITIG® 18F	4 m	ED	ZA - WZ-0 Tuchel 5-pol.	Standard	7S4FK043510302A12
	8 m	ED	ZA - WZ-0 Tuchel 5-pol.	Standard	7S4FK083510302A12
	4 m	ED	ZA - WZ-0 Tuchel 5-pol.	High Flex Leder	7S4FH043510302A12
	8 m	ED	ZA - WZ-0 Tuchel 5-pol.	High Flex Leder	7S4FH083510302A12
ABITIG® 20	4 m	ED	ZA - WZ-0 Tuchel 5-pol.	Standard	7S5SK043510302A12
	8 m	ED	ZA - WZ-0 Tuchel 5-pol.	Standard	7S5SK083510302A12
	4 m	ED	ZA - WZ-0 Tuchel 5-pol.	High Flex Leder	7S5SH043510302A12
	8 m	ED	ZA - WZ-0 Tuchel 5-pol.	High Flex Leder	7S5SH083510302A12
ABITIG® 20 Little	4 m	ED	ZA - WZ-0 Tuchel 5-pol.	High Flex Leder	7L5SH043510302A12
	8 m	ED	ZA - WZ-0 Tuchel 5-pol.	High Flex Leder	7L5SH083510302A12
ABITIG® 20F	4 m	ED	ZA - WZ-0 Tuchel 5-pol.	Standard	7S5FK043510302A12
	8 m	ED	ZA - WZ-0 Tuchel 5-pol.	Standard	7S5FK083510302A12
	4 m	ED	ZA - WZ-0 Tuchel 5-pol.	High Flex Leder	7S5FH043510302A12
	8 m	ED	ZA - WZ-0 Tuchel 5-pol.	High Flex Leder	7S5FH083510302A12
ABITIG® 20F Little	4 m	ED	ZA - WZ-0 Tuchel 5-pol.	High Flex Leder	7L5FH043510302A12
	8 m	ED	ZA - WZ-0 Tuchel 5-pol.	High Flex Leder	7L5FH083510302A12

Technische Änderungen vorbehalten • Verkaufspreise = unverbindliche Preisempfehlung - Angebot freibleibend • © Copyright

ABITIG® GRIP / ABITIG® GRIP Little-Brennerpreisliste

passend für WIG-Stromquellen des Fabrikates „castolin“

Brennertyp	Länge	Schalterfunktion	maschinenseitiger Anschluss	Schlauchpaketausführung	Bestellnummer
ABITIG® 12-1	4 m	ED	ZA - WZ-0 Tuchel 5-pol.	Standard	7S6SK043510302A12
	8 m	ED	ZA - WZ-0 Tuchel 5-pol.	Standard	7S6SK083510302A12
	4 m	ED	ZA - WZ-0 Tuchel 5-pol.	High Flex Leder	7S6SH043510302A12
	8 m	ED	ZA - WZ-0 Tuchel 5-pol.	High Flex Leder	7S6SH083510302A12
<hr/>					
ABITIG® 18SC	4 m	ED	ZA - WZ-0 Tuchel 5-pol.	Standard	7S7SK043510302A12
	8 m	ED	ZA - WZ-0 Tuchel 5-pol.	Standard	7S7SK083510302A12
	4 m	ED	ZA - WZ-0 Tuchel 5-pol.	High Flex Leder	7S7SH043510302A12
	8 m	ED	ZA - WZ-0 Tuchel 5-pol.	High Flex Leder	7S7SH083510302A12
<hr/>					
ABITIG® 24W	4 m	ED	ZA - WZ-0 Tuchel 5-pol.	Standard	7S9SK043510302A12
	8 m	ED	ZA - WZ-0 Tuchel 5-pol.	Standard	7S9SK083510302A12
	4 m	ED	ZA - WZ-0 Tuchel 5-pol.	High Flex Leder	7S9SH043510302A12
	8 m	ED	ZA - WZ-0 Tuchel 5-pol.	High Flex Leder	7S9SH083510302A12
ABITIG® 24W Little	4 m	ED	ZA - WZ-0 Tuchel 5-pol.	High Flex Leder	7L9SH043510302A12
	8 m	ED	ZA - WZ-0 Tuchel 5-pol.	High Flex Leder	7L9SH083510302A12
<hr/>					
ABITIG® 450W	4 m	ED	ZA - WZ-0 Tuchel 5-pol.	Standard	7T5SK043510302A12
	8 m	ED	ZA - WZ-0 Tuchel 5-pol.	Standard	7T5SK083510302A12
	4 m	ED	ZA - WZ-0 Tuchel 5-pol.	High Flex Leder	7T5SH043510302A12
	8 m	ED	ZA - WZ-0 Tuchel 5-pol.	High Flex Leder	7T5SH083510302A12
<hr/>					
ABITIG® 260W	4 m	ED	ZA - WZ-0 Tuchel 5-pol.	Standard	7T7SK043510302A12
	8 m	ED	ZA - WZ-0 Tuchel 5-pol.	Standard	7T7SK083510302A12
	4 m	ED	ZA - WZ-0 Tuchel 5-pol.	High Flex Leder	7T7SH043510302A12
	8 m	ED	ZA - WZ-0 Tuchel 5-pol.	High Flex Leder	7T7SH083510302A12
ABITIG® 260W Little	4 m	ED	ZA - WZ-0 Tuchel 5-pol.	High Flex Leder	7L7SH043510302A12
	8 m	ED	ZA - WZ-0 Tuchel 5-pol.	High Flex Leder	7L7SH083510302A12
<hr/>					
ABITIG® 450W SC	4 m	ED	ZA - WZ-0 Tuchel 5-pol.	Standard	
	8 m	ED	ZA - WZ-0 Tuchel 5-pol.	Standard	
	4 m	ED	ZA - WZ-0 Tuchel 5-pol.	High Flex Leder	7T8SH043510302A12
	8 m	ED	ZA - WZ-0 Tuchel 5-pol.	High Flex Leder	7T8SH083510302A12

ABITIG® GRIP / ABITIG® GRIP Little-Brennerpreisliste

passend für WIG-Stromquellen des Fabrikates „castolin“ Up/Down

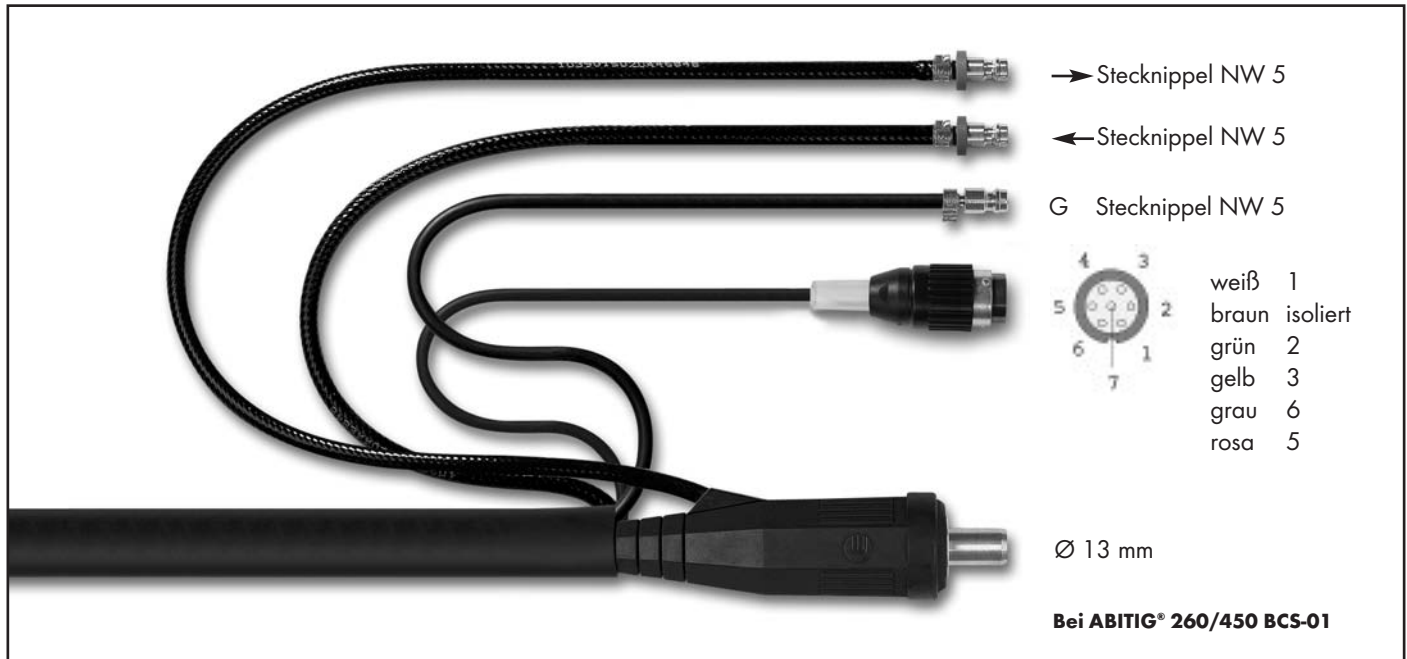

Brennertyp	Länge	Schalterfunktion	maschinenseitiger Anschluss	Schlauchpaketausführung	Bestellnummer
ABITIG® 18	4 m	UD	BSB 35-50 Tuchel 7-pol.	Standard	7S4SK046650018A20
	8 m	UD	BSB 35-50 Tuchel 7-pol.	Standard	7S4SK086650018A20
	4 m	UD	BSB 35-50 Tuchel 7-pol.	High Flex Leder	7S4SH046650018A20
	8 m	UD	BSB 35-50 Tuchel 7-pol.	High Flex Leder	7S4SH086650018A20
ABITIG® 18F	4 m	UD	BSB 35-50 Tuchel 7-pol.	Standard	7S4FK046650018A20
	8 m	UD	BSB 35-50 Tuchel 7-pol.	Standard	7S4FK086650018A20
	4 m	UD	BSB 35-50 Tuchel 7-pol.	High Flex Leder	7S4FH046650018A20
	8 m	UD	BSB 35-50 Tuchel 7-pol.	High Flex Leder	7S4FH086650018A20
ABITIG® 20	4 m	UD	BSB 35-50 Tuchel 7-pol.	Standard	7S5SK046650018A20
	8 m	UD	BSB 35-50 Tuchel 7-pol.	Standard	7S5SK086650018A20
	4 m	UD	BSB 35-50 Tuchel 7-pol.	High Flex Leder	7S5SH046650018A20
	8 m	UD	BSB 35-50 Tuchel 7-pol.	High Flex Leder	7S5SH086650018A20
ABITIG® 20 Little	4 m	UD	BSB 35-50 Tuchel 7-pol.	High Flex Leder	7L5SH046650018A20
	8 m	UD	BSB 35-50 Tuchel 7-pol.	High Flex Leder	7L5SH086650018A20
ABITIG® 20F	4 m	UD	BSB 35-50 Tuchel 7-pol.	Standard	7S5FK046650018A20
	8 m	UD	BSB 35-50 Tuchel 7-pol.	Standard	7S5FK086650018A20
	4 m	UD	BSB 35-50 Tuchel 7-pol.	High Flex Leder	7S5FH046650018A20
	8 m	UD	BSB 35-50 Tuchel 7-pol.	High Flex Leder	7S5FH086650018A20
ABITIG® 20F Little	4 m	UD	BSB 35-50 Tuchel 7-pol.	High Flex Leder	7L5FH046650018A20
	8 m	UD	BSB 35-50 Tuchel 7-pol.	High Flex Leder	7L5FH086650018A20

Technische Änderungen vorbehalten • Verkaufspreise = unverbindliche Preisempfehlung - Angebot freibleibend • © Copyright

ABITIG® GRIP / ABITIG® GRIP Little-Brennerpreisliste

passend für WIG-Stromquellen des Fabrikates „castolin“ Up/Down

Brennertyp	Länge	Schalterfunktion	maschinenseitiger Anschluss	Schlauchpaketausführung	Bestellnummer
ABITIG® 12-1	4 m	UD	BSB 35-50 Tuchel 7-pol.	Standard	7S6SK046650018A20
	8 m	UD	BSB 35-50 Tuchel 7-pol.	Standard	7S6SK086650018A20
	4 m	UD	BSB 35-50 Tuchel 7-pol.	High Flex Leder	7S6SH046650018A20
	8 m	UD	BSB 35-50 Tuchel 7-pol.	High Flex Leder	7S6SH086650018A20
<hr/>					
ABITIG® 18SC	4 m	UD	BSB 35-50 Tuchel 7-pol.	Standard	7S7SK046650018A20
	8 m	UD	BSB 35-50 Tuchel 7-pol.	Standard	7S7SK086650018A20
	4 m	UD	BSB 35-50 Tuchel 7-pol.	High Flex Leder	7S7SH046650018A20
	8 m	UD	BSB 35-50 Tuchel 7-pol.	High Flex Leder	7S7SH086650018A20
<hr/>					
ABITIG® 24W	4 m	UD	BSB 35-50 Tuchel 7-pol.	Standard	7S9SK046650018A20
	8 m	UD	BSB 35-50 Tuchel 7-pol.	Standard	7S9SK086650018A20
	4 m	UD	BSB 35-50 Tuchel 7-pol.	High Flex Leder	7S9SH046650018A20
	8 m	UD	BSB 35-50 Tuchel 7-pol.	High Flex Leder	7S9SH086650018A20
ABITIG® 24W Little	4 m	UD	BSB 35-50 Tuchel 7-pol.	High Flex Leder	7L9SH046650018A20
	8 m	UD	BSB 35-50 Tuchel 7-pol.	High Flex Leder	7L9SH086650018A20
<hr/>					
ABITIG® 450W	4 m	UD	BSB 35-50 Tuchel 7-pol.	Standard	7T5SK046650118A20
	8 m	UD	BSB 35-50 Tuchel 7-pol.	Standard	7T5SK086650118A20
	4 m	UD	BSB 35-50 Tuchel 7-pol.	High Flex Leder	7T5SH046650118A20
	8 m	UD	BSB 35-50 Tuchel 7-pol.	High Flex Leder	7T5SH086650118A20
<hr/>					
ABITIG® 260W	4 m	UD	BSB 35-50 Tuchel 7-pol.	Standard	7T7SK046650118A20
	8 m	UD	BSB 35-50 Tuchel 7-pol.	Standard	7T7SK086650118A20
	4 m	UD	BSB 35-50 Tuchel 7-pol.	High Flex Leder	7T7SH046650118A20
	8 m	UD	BSB 35-50 Tuchel 7-pol.	High Flex Leder	7T7SH086650118A20
ABITIG® 260W Little	4 m	UD	BSB 35-50 Tuchel 7-pol.	High Flex Leder	7L7SH046650118A20
	8 m	UD	BSB 35-50 Tuchel 7-pol.	High Flex Leder	7L7SH086650118A20
<hr/>					
ABITIG® 450W SC	4 m	UD	BSB 35-50 Tuchel 7-pol.	Standard	
	8 m	UD	BSB 35-50 Tuchel 7-pol.	Standard	
	4 m	UD	BSB 35-50 Tuchel 7-pol.	High Flex Leder	7T8SH046650118A20
	8 m	UD	BSB 35-50 Tuchel 7-pol.	High Flex Leder	7T8SH086650118A20

ABITIG® GRIP / ABITIG® GRIP Little-Brennerpreisliste

passend für WIG-Stromquellen des Fabrikates „cebora“

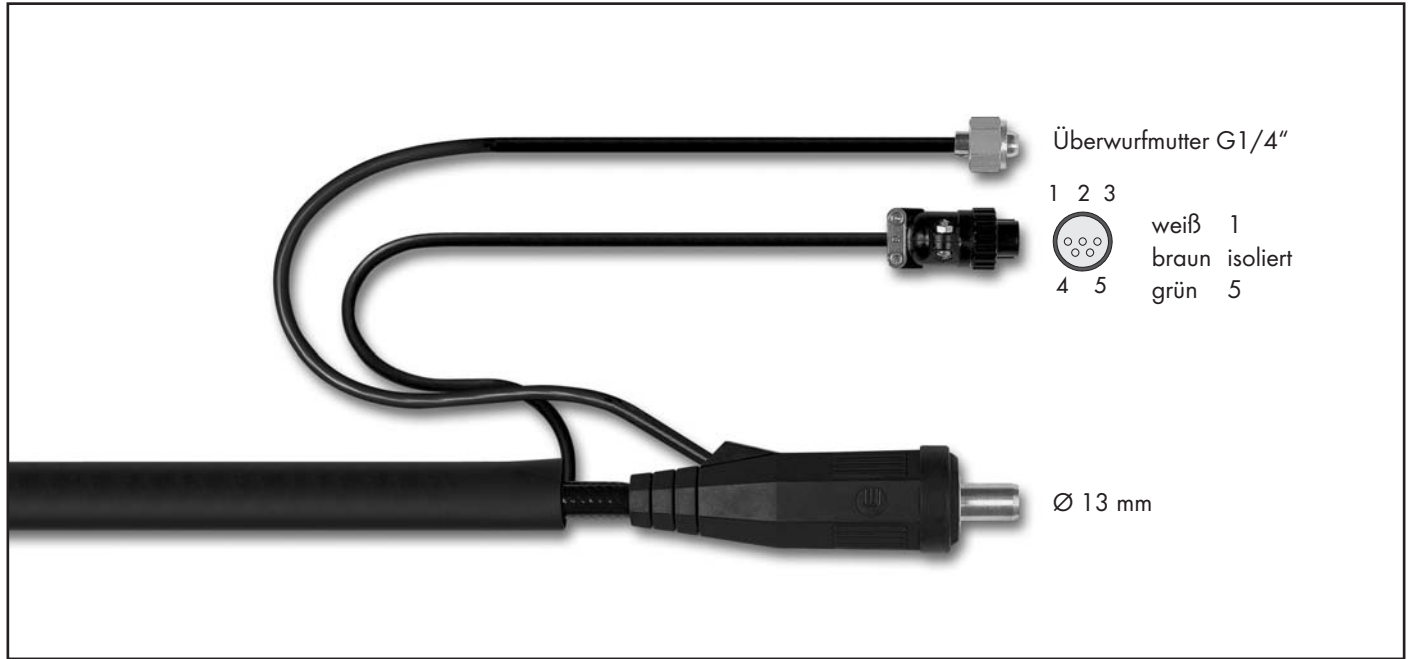

Brennertyp	Länge	Schalterfunktion	maschinenseitiger Anschluss	Schlauchpaketausführung	Bestellnummer
ABITIG® 9	4 m	ED	BSB 35-50 DDK-Stecker 5-pol.	Standard	7S1SK043510043A01
	8 m	ED	BSB 35-50 DDK-Stecker 5-pol.	Standard	7S1SK083510043A01
	4 m	ED	BSB 35-50 DDK-Stecker 5-pol.	High Flex Leder	7S1SH043510043A01
	8 m	ED	BSB 35-50 DDK-Stecker 5-pol.	High Flex Leder	7S1SH083510043A01
ABITIG® 9 Little	4 m	ED	BSB 35-50 DDK-Stecker 5-pol.	High Flex Leder	7L1SH043510043A01
	8 m	ED	BSB 35-50 DDK-Stecker 5-pol.	High Flex Leder	7L1SH083510043A01
ABITIG® 9F	4 m	ED	BSB 35-50 DDK-Stecker 5-pol.	Standard	7S1FK043510043A01
	8 m	ED	BSB 35-50 DDK-Stecker 5-pol.	Standard	7S1FK083510043A01
	4 m	ED	BSB 35-50 DDK-Stecker 5-pol.	High Flex Leder	7S1FH043510043A01
	8 m	ED	BSB 35-50 DDK-Stecker 5-pol.	High Flex Leder	7S1FH083510043A01
ABITIG® 9F Little	4 m	ED	BSB 35-50 DDK-Stecker 5-pol.	High Flex Leder	7L1FH043510043A01
	8 m	ED	BSB 35-50 DDK-Stecker 5-pol.	High Flex Leder	7L1FH083510043A01
ABITIG® 17	4 m	ED	BSB 35-50 DDK-Stecker 5-pol.	Standard	7S2SK043510043A01
	8 m	ED	BSB 35-50 DDK-Stecker 5-pol.	Standard	7S2SK083510043A01
	4 m	ED	BSB 35-50 DDK-Stecker 5-pol.	High Flex Leder	7S2SH043510043A01
	8 m	ED	BSB 35-50 DDK-Stecker 5-pol.	High Flex Leder	7S2SH083510043A01
ABITIG® 17 Little	4 m	ED	BSB 35-50 DDK-Stecker 5-pol.	High Flex Leder	7L2SH043510043A01
	8 m	ED	BSB 35-50 DDK-Stecker 5-pol.	High Flex Leder	7L2SH083510043A01
ABITIG® 17F	4 m	ED	BSB 35-50 DDK-Stecker 5-pol.	Standard	7S2FK043510043A01
	8 m	ED	BSB 35-50 DDK-Stecker 5-pol.	Standard	7S2FK083510043A01
	4 m	ED	BSB 35-50 DDK-Stecker 5-pol.	High Flex Leder	7S2FH043510043A01
	8 m	ED	BSB 35-50 DDK-Stecker 5-pol.	High Flex Leder	7S2FH083510043A01
ABITIG® 17F Little	4 m	ED	BSB 35-50 DDK-Stecker 5-pol.	High Flex Leder	7L2FH043510043A01
	8 m	ED	BSB 35-50 DDK-Stecker 5-pol.	High Flex Leder	7L2FH083510043A01

Technische Änderungen vorbehalten • Verkaufspreise = unverbindliche Preisempfehlung - Angebot freibleibend • © Copyright

ABITIG® GRIP / ABITIG® GRIP Little-Brennerpreisliste

passend für WIG-Stromquellen des Fabrikates „cebora“

Brennertyp	Länge	Schalterfunktion	maschinenseitiger Anschluss	Schlauchpaketausführung	Bestellnummer
ABITIG® 26	4 m	ED	BSB 35-50 DDK-Stecker 5-pol.	Standard	7S3SK043510043A01
	8 m	ED	BSB 35-50 DDK-Stecker 5-pol.	Standard	7S3SK083510043A01
	4 m	ED	BSB 35-50 DDK-Stecker 5-pol.	High Flex Leder	7S3SH043510043A01
	8 m	ED	BSB 35-50 DDK-Stecker 5-pol.	High Flex Leder	7S3SH083510043A01
ABITIG® 26F	4 m	ED	BSB 35-50 DDK-Stecker 5-pol.	Standard	7S3FK043510043A01
	8 m	ED	BSB 35-50 DDK-Stecker 5-pol.	Standard	7S3FK083510043A01
	4 m	ED	BSB 35-50 DDK-Stecker 5-pol.	High Flex Leder	7S3FH043510043A01
	8 m	ED	BSB 35-50 DDK-Stecker 5-pol.	High Flex Leder	7S3FH083510043A01
ABITIG® 24G	4 m	ED	BSB 35-50 DDK-Stecker 5-pol.	Standard	7S8SK043510043A01
	8 m	ED	BSB 35-50 DDK-Stecker 5-pol.	Standard	7S8SK083510043A01
	4 m	ED	BSB 35-50 DDK-Stecker 5-pol.	High Flex Leder	7S8SH043510043A01
	8 m	ED	BSB 35-50 DDK-Stecker 5-pol.	High Flex Leder	7S8SH083510043A01
ABITIG® 24G Little	4 m	ED	BSB 35-50 DDK-Stecker 5-pol.	High Flex Leder	7L8SH043510043A01
	8 m	ED	BSB 35-50 DDK-Stecker 5-pol.	High Flex Leder	7L8SH083510043A01
ABITIG® 200	4 m	ED	BSB 35-50 DDK-Stecker 5-pol.	Standard	7T4SK043510043A01
	8 m	ED	BSB 35-50 DDK-Stecker 5-pol.	Standard	7T4SK083510043A01
	4 m	ED	BSB 35-50 DDK-Stecker 5-pol.	High Flex Leder	7T4SH043510043A01
	8 m	ED	BSB 35-50 DDK-Stecker 5-pol.	High Flex Leder	7T4SH083510043A01
ABITIG® 200F	4 m	ED	BSB 35-50 DDK-Stecker 5-pol.	Standard	7T4FK043510043A01
	8 m	ED	BSB 35-50 DDK-Stecker 5-pol.	Standard	7T4FK083510043A01
	4 m	ED	BSB 35-50 DDK-Stecker 5-pol.	High Flex Leder	7T4FH043510043A01
	8 m	ED	BSB 35-50 DDK-Stecker 5-pol.	High Flex Leder	7T4FH083510043A01
ABITIG® 150	4 m	ED	BSB 35-50 DDK-Stecker 5-pol.	Standard	7T6SK043510043A01
	8 m	ED	BSB 35-50 DDK-Stecker 5-pol.	Standard	7T6SK083510043A01
	4 m	ED	BSB 35-50 DDK-Stecker 5-pol.	High Flex Leder	7T6SH043510043A01
	8 m	ED	BSB 35-50 DDK-Stecker 5-pol.	High Flex Leder	7T6SH083510043A01
ABITIG® 150 Little	4 m	ED	BSB 35-50 DDK-Stecker 5-pol.	High Flex Leder	7L6SH043510043A01
	8 m	ED	BSB 35-50 DDK-Stecker 5-pol.	High Flex Leder	7L6SH083510043A01
ABITIG® 150F	4 m	ED	BSB 35-50 DDK-Stecker 5-pol.	Standard	7T6FK043510043A01
	8 m	ED	BSB 35-50 DDK-Stecker 5-pol.	Standard	7T6FK083510043A01
	4 m	ED	BSB 35-50 DDK-Stecker 5-pol.	High Flex Leder	7T6FH043510043A01
	8 m	ED	BSB 35-50 DDK-Stecker 5-pol.	High Flex Leder	7T6FH083510043A01
ABITIG® 150F Little	4 m	ED	BSB 35-50 DDK-Stecker 5-pol.	High Flex Leder	7L6FH043510043A01
	8 m	ED	BSB 35-50 DDK-Stecker 5-pol.	High Flex Leder	7L6FH083510043A01

ABITIG® GRIP / ABITIG® GRIP Little-Brennerpreisliste

passend für WIG-Stromquellen des Fabrikates „cebora“

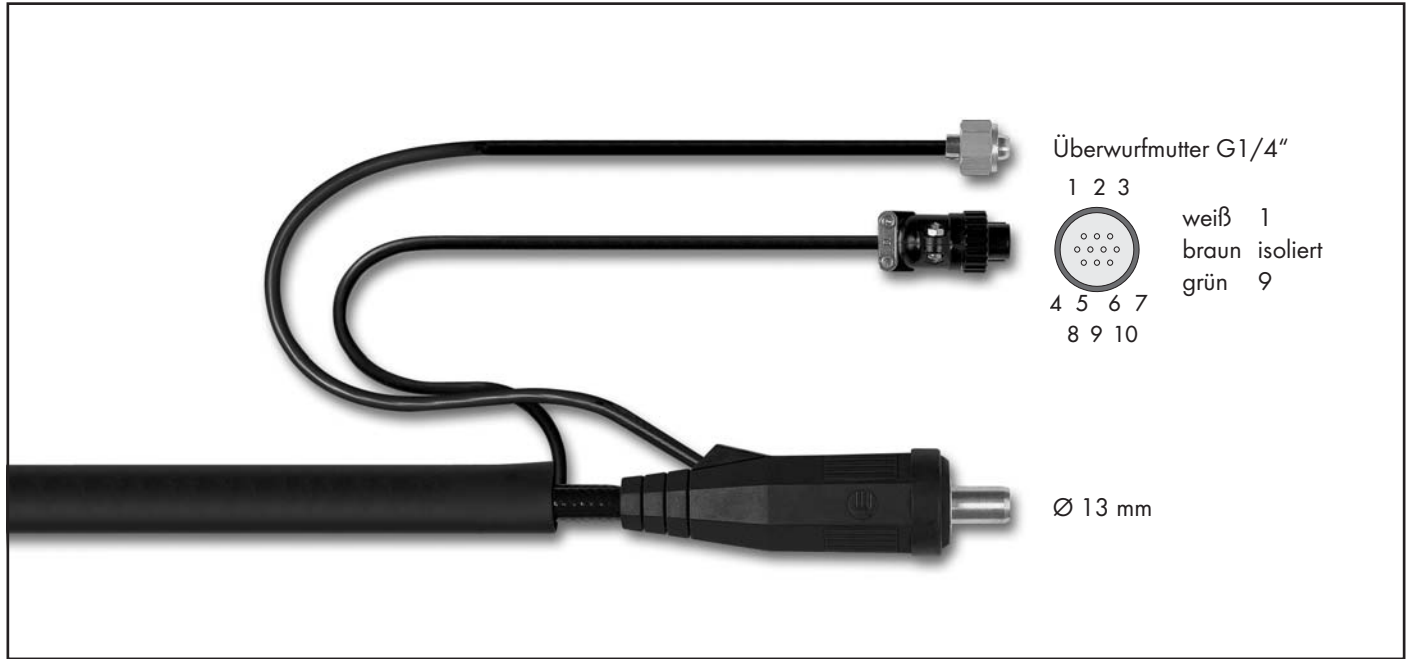

Brennertyp	Länge	Schalterfunktion	maschinenseitiger Anschluss	Schlauchpaketausführung	Bestellnummer
ABITIG® 9	4 m	ED	BSB 35-50 DDK-Stecker 10-pol.	Standard	7S1SK043510043C01
	8 m	ED	BSB 35-50 DDK-Stecker 10-pol.	Standard	7S1SK083510043C01
	4 m	ED	BSB 35-50 DDK-Stecker 10-pol.	High Flex Leder	7S1SH043510043C01
	8 m	ED	BSB 35-50 DDK-Stecker 10-pol.	High Flex Leder	7S1SH083510043C01
ABITIG® 9 Little	4 m	ED	BSB 35-50 DDK-Stecker 10-pol.	High Flex Leder	7L1SH043510043C01
	8 m	ED	BSB 35-50 DDK-Stecker 10-pol.	High Flex Leder	7L1SH083510043C01
ABITIG® 9F	4 m	ED	BSB 35-50 DDK-Stecker 10-pol.	Standard	7S1FK043510043C01
	8 m	ED	BSB 35-50 DDK-Stecker 10-pol.	Standard	7S1FK083510043C01
	4 m	ED	BSB 35-50 DDK-Stecker 10-pol.	High Flex Leder	7S1FH043510043C01
	8 m	ED	BSB 35-50 DDK-Stecker 10-pol.	High Flex Leder	7S1FH083510043C01
ABITIG® 9F Little	4 m	ED	BSB 35-50 DDK-Stecker 10-pol.	High Flex Leder	7L1FH043510043C01
	8 m	ED	BSB 35-50 DDK-Stecker 10-pol.	High Flex Leder	7L1FH083510043C01
ABITIG® 17	4 m	ED	BSB 35-50 DDK-Stecker 10-pol.	Standard	7S2SK043510043C01
	8 m	ED	BSB 35-50 DDK-Stecker 10-pol.	Standard	7S2SK083510043C01
	4 m	ED	BSB 35-50 DDK-Stecker 10-pol.	High Flex Leder	7S2SH043510043C01
	8 m	ED	BSB 35-50 DDK-Stecker 10-pol.	High Flex Leder	7S2SH083510043C01
ABITIG® 17 Little	4 m	ED	BSB 35-50 DDK-Stecker 10-pol.	High Flex Leder	7L2SH043510043C01
	8 m	ED	BSB 35-50 DDK-Stecker 10-pol.	High Flex Leder	7L2SH083510043C01
ABITIG® 17F	4 m	ED	BSB 35-50 DDK-Stecker 10-pol.	Standard	7S2FK043510043C01
	8 m	ED	BSB 35-50 DDK-Stecker 10-pol.	Standard	7S2FK083510043C01
	4 m	ED	BSB 35-50 DDK-Stecker 10-pol.	High Flex Leder	7S2FH043510043C01
	8 m	ED	BSB 35-50 DDK-Stecker 10-pol.	High Flex Leder	7S2FH083510043C01
ABITIG® 17F Little	4 m	ED	BSB 35-50 DDK-Stecker 10-pol.	High Flex Leder	7L2FH043510043C01
	8 m	ED	BSB 35-50 DDK-Stecker 10-pol.	High Flex Leder	7L2FH083510043C01

Technische Änderungen vorbehalten • Verkaufspreise = unverbindliche Preisempfehlung - Angebot freibleibend • © Copyright

ABITIG® GRIP / ABITIG® GRIP Little-Brennerpreisliste

passend für WIG-Stromquellen des Fabrikates „cebora“

Brennertyp	Länge	Schalterfunktion	maschinenseitiger Anschluss	Schlauchpaketausführung	Bestellnummer
ABITIG® 26	4 m	ED	BSB 35-50 DDK-Stecker 10-pol.	Standard	7S3SK043510043C01
	8 m	ED	BSB 35-50 DDK-Stecker 10-pol.	Standard	7S3SK083510043C01
	4 m	ED	BSB 35-50 DDK-Stecker 10-pol.	High Flex Leder	7S3SH043510043C01
	8 m	ED	BSB 35-50 DDK-Stecker 10-pol.	High Flex Leder	7S3SH083510043C01
ABITIG® 26F	4 m	ED	BSB 35-50 DDK-Stecker 10-pol.	Standard	7S3FK043510043C01
	8 m	ED	BSB 35-50 DDK-Stecker 10-pol.	Standard	7S3FK083510043C01
	4 m	ED	BSB 35-50 DDK-Stecker 10-pol.	High Flex Leder	7S3FH043510043C01
	8 m	ED	BSB 35-50 DDK-Stecker 10-pol.	High Flex Leder	7S3FH083510043C01
ABITIG® 24G	4 m	ED	BSB 35-50 DDK-Stecker 10-pol.	Standard	7S8SK043510043C01
	8 m	ED	BSB 35-50 DDK-Stecker 10-pol.	Standard	7S8SK083510043C01
	4 m	ED	BSB 35-50 DDK-Stecker 10-pol.	High Flex Leder	7S8SH043510043C01
	8 m	ED	BSB 35-50 DDK-Stecker 10-pol.	High Flex Leder	7S8SH083510043C01
ABITIG® 24G Little	4 m	ED	BSB 35-50 DDK-Stecker 10-pol.	High Flex Leder	7L8SH043510043C01
	8 m	ED	BSB 35-50 DDK-Stecker 10-pol.	High Flex Leder	7L8SH083510043C01
ABITIG® 200	4 m	ED	BSB 35-50 DDK-Stecker 10-pol.	Standard	7T4SK043510043C01
	8 m	ED	BSB 35-50 DDK-Stecker 10-pol.	Standard	7T4SK083510043C01
	4 m	ED	BSB 35-50 DDK-Stecker 10-pol.	High Flex Leder	7T4SH043510043C01
	8 m	ED	BSB 35-50 DDK-Stecker 10-pol.	High Flex Leder	7T4SH083510043C01
ABITIG® 200F	4 m	ED	BSB 35-50 DDK-Stecker 10-pol.	Standard	7T4FK043510043C01
	8 m	ED	BSB 35-50 DDK-Stecker 10-pol.	Standard	7T4FK083510043C01
	4 m	ED	BSB 35-50 DDK-Stecker 10-pol.	High Flex Leder	7T4FH043510043C01
	8 m	ED	BSB 35-50 DDK-Stecker 10-pol.	High Flex Leder	7T4FH083510043C01
ABITIG® 150	4 m	ED	BSB 35-50 DDK-Stecker 10-pol.	Standard	7T6SK043510043C01
	8 m	ED	BSB 35-50 DDK-Stecker 10-pol.	Standard	7T6SK083510043C01
	4 m	ED	BSB 35-50 DDK-Stecker 10-pol.	High Flex Leder	7T6SH043510043C01
	8 m	ED	BSB 35-50 DDK-Stecker 10-pol.	High Flex Leder	7T6SH083510043C01
ABITIG® 150 Little	4 m	ED	BSB 35-50 DDK-Stecker 10-pol.	High Flex Leder	7L6SH043510043C01
	8 m	ED	BSB 35-50 DDK-Stecker 10-pol.	High Flex Leder	7L6SH083510043C01
ABITIG® 150F	4 m	ED	BSB 35-50 DDK-Stecker 10-pol.	Standard	7T6FK043510043C01
	8 m	ED	BSB 35-50 DDK-Stecker 10-pol.	Standard	7T6FK083510043C01
	4 m	ED	BSB 35-50 DDK-Stecker 10-pol.	High Flex Leder	7T6FH043510043C01
	8 m	ED	BSB 35-50 DDK-Stecker 10-pol.	High Flex Leder	7T6FH083510043C01
ABITIG® 150F Little	4 m	ED	BSB 35-50 DDK-Stecker 10-pol.	High Flex Leder	7L6FH043510043C01
	8 m	ED	BSB 35-50 DDK-Stecker 10-pol.	High Flex Leder	7L6FH083510043C01

ABITIG® GRIP / ABITIG® GRIP Little-Brennerpreisliste

passend für WIG-Stromquellen des Fabrikates „ceborä“ Up/Down

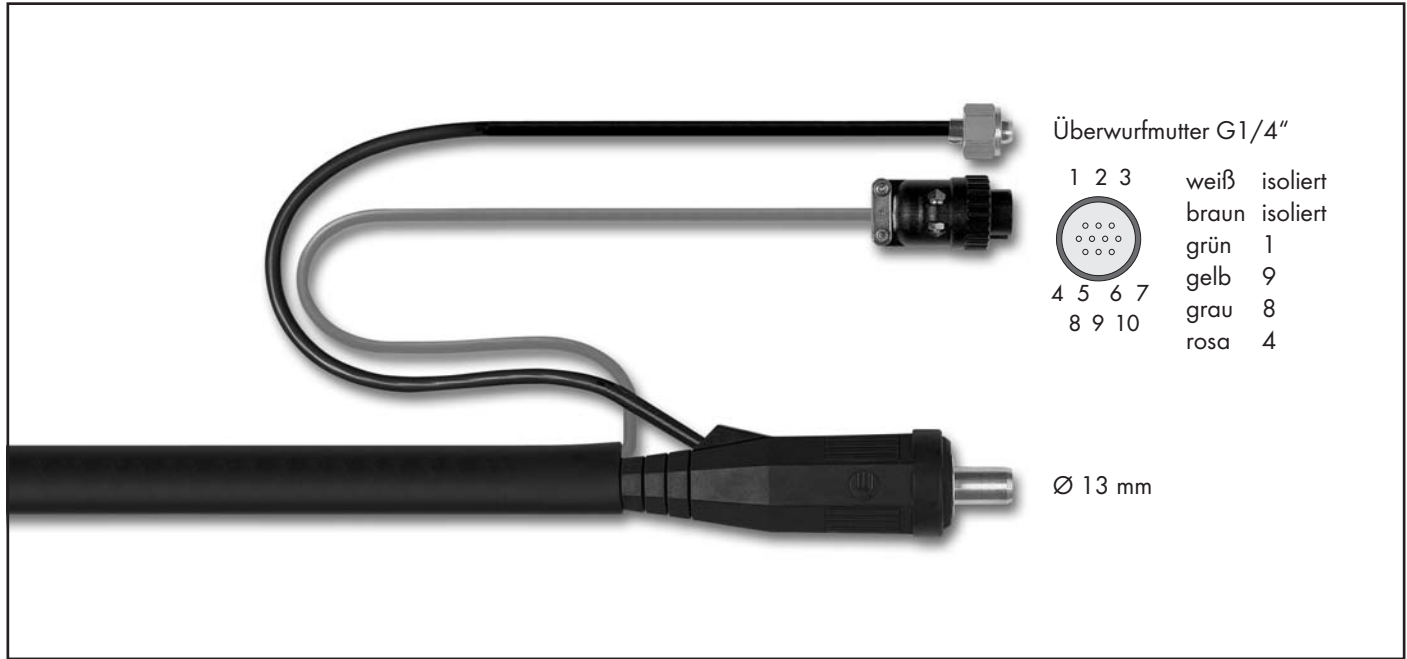

Brennertyp	Länge	Schalterfunktion	maschinenseitiger Anschluss	Schlauchpaketausführung	Bestellnummer
ABITIG® 9	4 m	UD	BSB 35-50 DDK-Stecker 10-pol.	Standard	7S1SK046650043D01
	8 m	UD	BSB 35-50 DDK-Stecker 10-pol.	Standard	7S1SK086650043D01
	4 m	UD	BSB 35-50 DDK-Stecker 10-pol.	High Flex Leder	7S1SH046650043D01
	8 m	UD	BSB 35-50 DDK-Stecker 10-pol.	High Flex Leder	7S1SH086650043D01
ABITIG® 9 Little	4 m	UD	BSB 35-50 DDK-Stecker 10-pol.	High Flex Leder	7L1SH046650043D01
	8 m	UD	BSB 35-50 DDK-Stecker 10-pol.	High Flex Leder	7L1SH086650043D01
ABITIG® 9F	4 m	UD	BSB 35-50 DDK-Stecker 10-pol.	Standard	7S1FK046650043D01
	8 m	UD	BSB 35-50 DDK-Stecker 10-pol.	Standard	7S1FK086650043D01
	4 m	UD	BSB 35-50 DDK-Stecker 10-pol.	High Flex Leder	7S1FH046650043D01
	8 m	UD	BSB 35-50 DDK-Stecker 10-pol.	High Flex Leder	7S1FH086650043D01
ABITIG® 9F Little	4 m	UD	BSB 35-50 DDK-Stecker 10-pol.	High Flex Leder	7L1FH046650043D01
	8 m	UD	BSB 35-50 DDK-Stecker 10-pol.	High Flex Leder	7L1FH086650043D01
ABITIG® 17	4 m	UD	BSB 35-50 DDK-Stecker 10-pol.	Standard	7S2SK046650043D01
	8 m	UD	BSB 35-50 DDK-Stecker 10-pol.	Standard	7S2SK086650043D01
	4 m	UD	BSB 35-50 DDK-Stecker 10-pol.	High Flex Leder	7S2SH046650043D01
	8 m	UD	BSB 35-50 DDK-Stecker 10-pol.	High Flex Leder	7S2SH086650043D01
ABITIG® 17 Little	4 m	UD	BSB 35-50 DDK-Stecker 10-pol.	High Flex Leder	7L2SH046650043D01
	8 m	UD	BSB 35-50 DDK-Stecker 10-pol.	High Flex Leder	7L2SH086650043D01
ABITIG® 17F	4 m	UD	BSB 35-50 DDK-Stecker 10-pol.	Standard	7S2FK046650043D01
	8 m	UD	BSB 35-50 DDK-Stecker 10-pol.	Standard	7S2FK086650043D01
	4 m	UD	BSB 35-50 DDK-Stecker 10-pol.	High Flex Leder	7S2FH046650043D01
	8 m	UD	BSB 35-50 DDK-Stecker 10-pol.	High Flex Leder	7S2FH086650043D01
ABITIG® 17F Little	4 m	UD	BSB 35-50 DDK-Stecker 10-pol.	High Flex Leder	7L2FH046650043D01
	8 m	UD	BSB 35-50 DDK-Stecker 10-pol.	High Flex Leder	7L2FH086650043D01

Technische Änderungen vorbehalten • Verkaufspreise = unverbindliche Preisempfehlung - Angebot freibleibend • © Copyright

ABITIG® GRIP / ABITIG® GRIP Little-Brennerpreisliste

passend für WIG-Stromquellen des Fabrikates „cebora“ Up/Down

Brennertyp	Länge	Schalterfunktion	maschinenseitiger Anschluss	Schlauchpaketausführung	Bestellnummer
ABITIG® 26	4 m	UD	BSB 35-50 DDK-Stecker 10-pol.	Standard	7S3SK046650043D01
	8 m	UD	BSB 35-50 DDK-Stecker 10-pol.	Standard	7S3SK086650043D01
	4 m	UD	BSB 35-50 DDK-Stecker 10-pol.	High Flex Leder	7S3SH046650043D01
	8 m	UD	BSB 35-50 DDK-Stecker 10-pol.	High Flex Leder	7S3SH086650043D01
ABITIG® 26F	4 m	UD	BSB 35-50 DDK-Stecker 10-pol.	Standard	7S3FK046650043D01
	8 m	UD	BSB 35-50 DDK-Stecker 10-pol.	Standard	7S3FK086650043D01
	4 m	UD	BSB 35-50 DDK-Stecker 10-pol.	High Flex Leder	7S3FH046650043D01
	8 m	UD	BSB 35-50 DDK-Stecker 10-pol.	High Flex Leder	7S3FH086650043D01
ABITIG® 24G	4 m	UD	BSB 35-50 DDK-Stecker 10-pol.	Standard	7S8SK046650043D01
	8 m	UD	BSB 35-50 DDK-Stecker 10-pol.	Standard	7S8SK086650043D01
	4 m	UD	BSB 35-50 DDK-Stecker 10-pol.	High Flex Leder	7S8SH046650043D01
	8 m	UD	BSB 35-50 DDK-Stecker 10-pol.	High Flex Leder	7S8SH086650043D01
ABITIG® 24G Little	4 m	UD	BSB 35-50 DDK-Stecker 10-pol.	High Flex Leder	7L8SH046650043D01
	8 m	UD	BSB 35-50 DDK-Stecker 10-pol.	High Flex Leder	7L8SH086650043D01
ABITIG® 200	4 m	UD	BSB 35-50 DDK-Stecker 10-pol.	Standard	7T4SK046650043D01
	8 m	UD	BSB 35-50 DDK-Stecker 10-pol.	Standard	7T4SK086650043D01
	4 m	UD	BSB 35-50 DDK-Stecker 10-pol.	High Flex Leder	7T4SH046650043D01
	8 m	UD	BSB 35-50 DDK-Stecker 10-pol.	High Flex Leder	7T4SH086650043D01
ABITIG® 200F	4 m	UD	BSB 35-50 DDK-Stecker 10-pol.	Standard	7T4FK046650043D01
	8 m	UD	BSB 35-50 DDK-Stecker 10-pol.	Standard	7T4FK086650043D01
	4 m	UD	BSB 35-50 DDK-Stecker 10-pol.	High Flex Leder	7T4FH046650043D01
	8 m	UD	BSB 35-50 DDK-Stecker 10-pol.	High Flex Leder	7T4FH086650043D01
ABITIG® 150	4 m	UD	BSB 35-50 DDK-Stecker 10-pol.	Standard	7T6SK046650043D01
	8 m	UD	BSB 35-50 DDK-Stecker 10-pol.	Standard	7T6SK086650043D01
	4 m	UD	BSB 35-50 DDK-Stecker 10-pol.	High Flex Leder	7T6SH046650043D01
	8 m	UD	BSB 35-50 DDK-Stecker 10-pol.	High Flex Leder	7T6SH086650043D01
ABITIG® 150 Little	4 m	UD	BSB 35-50 DDK-Stecker 10-pol.	High Flex Leder	7L6SH046650043D01
	8 m	UD	BSB 35-50 DDK-Stecker 10-pol.	High Flex Leder	7L6SH086650043D01
ABITIG® 150F	4 m	UD	BSB 35-50 DDK-Stecker 10-pol.	Standard	7T6FK046650043D01
	8 m	UD	BSB 35-50 DDK-Stecker 10-pol.	Standard	7T6FK086650043D01
	4 m	UD	BSB 35-50 DDK-Stecker 10-pol.	High Flex Leder	7T6FH046650043D01
	8 m	UD	BSB 35-50 DDK-Stecker 10-pol.	High Flex Leder	7T6FH086650043D01
ABITIG® 150F Little	4 m	UD	BSB 35-50 DDK-Stecker 10-pol.	High Flex Leder	7L6FH046650043D01
	8 m	UD	BSB 35-50 DDK-Stecker 10-pol.	High Flex Leder	7L6FH086650043D01

ABITIG® GRIP / ABITIG® GRIP Little-Brennerpreisliste

passend für WIG-Stromquellen des Fabrikates „cebora“

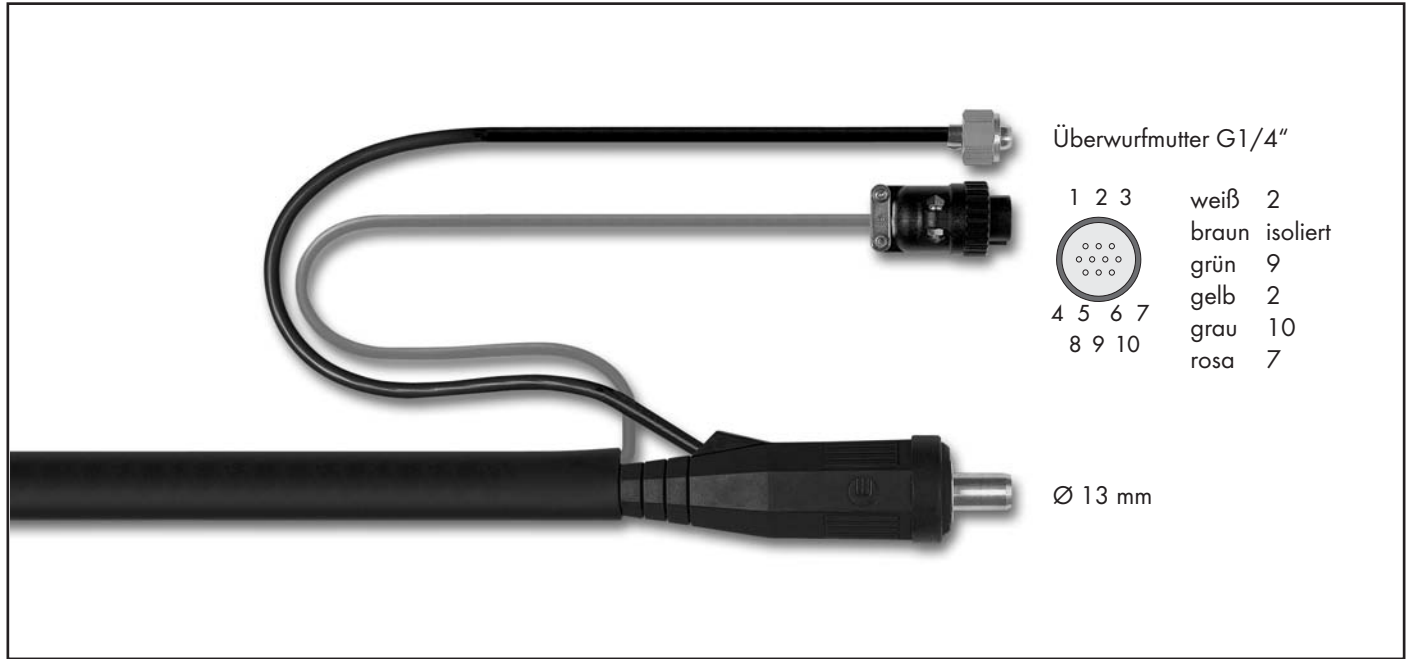

Brennertyp	Länge	Schalterfunktion	maschinenseitiger Anschluss	Schlauchpaketausführung	Bestellnummer
ABITIG® 9	4 m	EDP	BSB 35-50 DDK-Stecker 10-pol.	Standard	7S1SK046540043B01
	8 m	EDP	BSB 35-50 DDK-Stecker 10-pol.	Standard	7S1SK086540043B01
	4 m	EDP	BSB 35-50 DDK-Stecker 10-pol.	High Flex Leder	7S1SH046540043B01
	8 m	EDP	BSB 35-50 DDK-Stecker 10-pol.	High Flex Leder	7S1SH086540043B01
ABITIG® 9F	4 m	EDP	BSB 35-50 DDK-Stecker 10-pol.	Standard	7S1FK046540043B01
	8 m	EDP	BSB 35-50 DDK-Stecker 10-pol.	Standard	7S1FK086540043B01
	4 m	EDP	BSB 35-50 DDK-Stecker 10-pol.	High Flex Leder	7S1FH046540043B01
	8 m	EDP	BSB 35-50 DDK-Stecker 10-pol.	High Flex Leder	7S1FH086540043B01
ABITIG® 17	4 m	EDP	BSB 35-50 DDK-Stecker 10-pol.	Standard	7S2SK046540043B01
	8 m	EDP	BSB 35-50 DDK-Stecker 10-pol.	Standard	7S2SK086540043B01
	4 m	EDP	BSB 35-50 DDK-Stecker 10-pol.	High Flex Leder	7S2SH046540043B01
	8 m	EDP	BSB 35-50 DDK-Stecker 10-pol.	High Flex Leder	7S2SH086540043B01
ABITIG® 17F	4 m	EDP	BSB 35-50 DDK-Stecker 10-pol.	Standard	7S2FK046540043B01
	8 m	EDP	BSB 35-50 DDK-Stecker 10-pol.	Standard	7S2FK086540043B01
	4 m	EDP	BSB 35-50 DDK-Stecker 10-pol.	High Flex Leder	7S2FH046540043B01
	8 m	EDP	BSB 35-50 DDK-Stecker 10-pol.	High Flex Leder	7S2FH086540043B01

Technische Änderungen vorbehalten • Verkaufspreise = unverbindliche Preisempfehlung - Angebot freibleibend • © Copyright

ABITIG® GRIP / ABITIG® GRIP Little-Brennerpreisliste

passend für WIG-Stromquellen des Fabrikates „cebora“

Brennertyp	Länge	Schalterfunktion	maschinenseitiger Anschluss	Schlauchpaketausführung	Bestellnummer
ABITIG® 26	4 m	EDP	BSB 35-50 DDK-Stecker 10-pol.	Standard	7S3SK046540043B01
	8 m	EDP	BSB 35-50 DDK-Stecker 10-pol.	Standard	7S3SK086540043B01
	4 m	EDP	BSB 35-50 DDK-Stecker 10-pol.	High Flex Leder	7S3SH046540043B01
	8 m	EDP	BSB 35-50 DDK-Stecker 10-pol.	High Flex Leder	7S3SH086540043B01
ABITIG® 26F	4 m	EDP	BSB 35-50 DDK-Stecker 10-pol.	Standard	7S3FK046540043B01
	8 m	EDP	BSB 35-50 DDK-Stecker 10-pol.	Standard	7S3FK086540043B01
	4 m	EDP	BSB 35-50 DDK-Stecker 10-pol.	High Flex Leder	7S3FH046540043B01
	8 m	EDP	BSB 35-50 DDK-Stecker 10-pol.	High Flex Leder	7S3FH086540043B01
ABITIG® 24G	4 m	EDP	BSB 35-50 DDK-Stecker 10-pol.	Standard	7S8SK046540043B01
	8 m	EDP	BSB 35-50 DDK-Stecker 10-pol.	Standard	7S8SK086540043B01
	4 m	EDP	BSB 35-50 DDK-Stecker 10-pol.	High Flex Leder	7S8SH046540043B01
	8 m	EDP	BSB 35-50 DDK-Stecker 10-pol.	High Flex Leder	7S8SH086540043B01
ABITIG® 200	4 m	EDP	BSB 35-50 DDK-Stecker 10-pol.	Standard	7T4SK046540043B01
	8 m	EDP	BSB 35-50 DDK-Stecker 10-pol.	Standard	7T4SK086540043B01
	4 m	EDP	BSB 35-50 DDK-Stecker 10-pol.	High Flex Leder	7T4SH046540043B01
	8 m	EDP	BSB 35-50 DDK-Stecker 10-pol.	High Flex Leder	7T4SH086540043B01
ABITIG® 200F	4 m	EDP	BSB 35-50 DDK-Stecker 10-pol.	Standard	7T4FK046540043B01
	8 m	EDP	BSB 35-50 DDK-Stecker 10-pol.	Standard	7T4FK086540043B01
	4 m	EDP	BSB 35-50 DDK-Stecker 10-pol.	High Flex Leder	7T4FH046540043B01
	8 m	EDP	BSB 35-50 DDK-Stecker 10-pol.	High Flex Leder	7T4FH086540043B01
ABITIG® 150	4 m	EDP	BSB 35-50 DDK-Stecker 10-pol.	Standard	7T6SK046540043B01
	8 m	EDP	BSB 35-50 DDK-Stecker 10-pol.	Standard	7T6SK086540043B01
	4 m	EDP	BSB 35-50 DDK-Stecker 10-pol.	High Flex Leder	7T6SH046540043B01
	8 m	EDP	BSB 35-50 DDK-Stecker 10-pol.	High Flex Leder	7T6SH086540043B01
ABITIG® 150F	4 m	EDP	BSB 35-50 DDK-Stecker 10-pol.	Standard	7T6FK046540043B01
	8 m	EDP	BSB 35-50 DDK-Stecker 10-pol.	Standard	7T6FK086540043B01
	4 m	EDP	BSB 35-50 DDK-Stecker 10-pol.	High Flex Leder	7T6FH046540043B01
	8 m	EDP	BSB 35-50 DDK-Stecker 10-pol.	High Flex Leder	7T6FH086540043B01

ABITIG® GRIP / ABITIG® GRIP Little-Brennerpreisliste

passend für WIG-Stromquellen des Fabrikates „cebora“

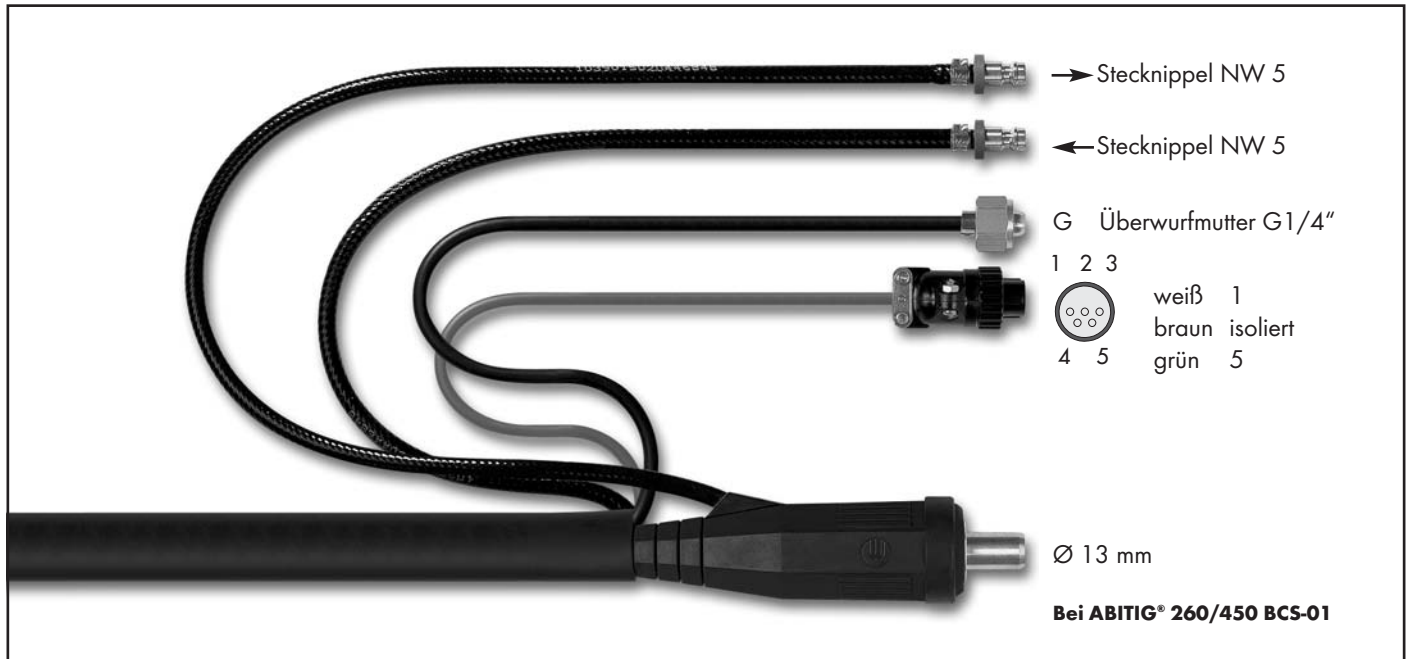

Brennertyp	Länge	Schalterfunktion	maschinenseitiger Anschluss	Schlauchpaketausführung	Bestellnummer
ABITIG® 18	4 m	ED	BSB 35-50 DDK-Stecker 5-pol.	Standard	7S4SK043510043A11
	8 m	ED	BSB 35-50 DDK-Stecker 5-pol.	Standard	7S4SK083510043A11
	4 m	ED	BSB 35-50 DDK-Stecker 5-pol.	High Flex Leder	7S4SH043510043A11
	8 m	ED	BSB 35-50 DDK-Stecker 5-pol.	High Flex Leder	7S4SH083510043A11
ABITIG® 18F	4 m	ED	BSB 35-50 DDK-Stecker 5-pol.	Standard	7S4FK043510043A11
	8 m	ED	BSB 35-50 DDK-Stecker 5-pol.	Standard	7S4FK083510043A11
	4 m	ED	BSB 35-50 DDK-Stecker 5-pol.	High Flex Leder	7S4FH043510043A11
	8 m	ED	BSB 35-50 DDK-Stecker 5-pol.	High Flex Leder	7S4FH083510043A11
ABITIG® 20	4 m	ED	BSB 35-50 DDK-Stecker 5-pol.	Standard	7S5SK043510043A11
	8 m	ED	BSB 35-50 DDK-Stecker 5-pol.	Standard	7S5SK083510043A11
	4 m	ED	BSB 35-50 DDK-Stecker 5-pol.	High Flex Leder	7S5SH043510043A11
	8 m	ED	BSB 35-50 DDK-Stecker 5-pol.	High Flex Leder	7S5SH083510043A11
ABITIG® 20 Little	4 m	ED	BSB 35-50 DDK-Stecker 5-pol.	High Flex Leder	7L5SH043510043A11
	8 m	ED	BSB 35-50 DDK-Stecker 5-pol.	High Flex Leder	7L5SH083510043A11
ABITIG® 20F	4 m	ED	BSB 35-50 DDK-Stecker 5-pol.	Standard	7S5FK043510043A11
	8 m	ED	BSB 35-50 DDK-Stecker 5-pol.	Standard	7S5FK083510043A11
	4 m	ED	BSB 35-50 DDK-Stecker 5-pol.	High Flex Leder	7S5FH043510043A11
	8 m	ED	BSB 35-50 DDK-Stecker 5-pol.	High Flex Leder	7S5FH083510043A11
ABITIG® 20F Little	4 m	ED	BSB 35-50 DDK-Stecker 5-pol.	High Flex Leder	7L5FH043510043A11
	8 m	ED	BSB 35-50 DDK-Stecker 5-pol.	High Flex Leder	7L5FH083510043A11

Technische Änderungen vorbehalten • Verkaufspreise = unverbindliche Preisempfehlung - Angebot freibleibend • © Copyright

ABITIG® GRIP / ABITIG® GRIP Little-Brennerpreisliste

passend für WIG-Stromquellen des Fabrikates „cebora“

Brennertyp	Länge	Schalterfunktion	maschinenseitiger Anschluss	Schlauchpaketausführung	Bestellnummer
ABITIG® 12-1	4 m	ED	BSB 35-50 DDK-Stecker 5-pol.	Standard	7S6SK043510043A11
	8 m	ED	BSB 35-50 DDK-Stecker 5-pol.	Standard	7S6SK083510043A11
	4 m	ED	BSB 35-50 DDK-Stecker 5-pol.	High Flex Leder	7S6SH043510043A11
	8 m	ED	BSB 35-50 DDK-Stecker 5-pol.	High Flex Leder	7S6SH083510043A11
ABITIG® 18SC	4 m	ED	BSB 35-50 DDK-Stecker 5-pol.	Standard	7S7SK043510043A11
	8 m	ED	BSB 35-50 DDK-Stecker 5-pol.	Standard	7S7SK083510043A11
	4 m	ED	BSB 35-50 DDK-Stecker 5-pol.	High Flex Leder	7S7SH043510043A11
	8 m	ED	BSB 35-50 DDK-Stecker 5-pol.	High Flex Leder	7S7SH083510043A11
ABITIG® 24W	4 m	ED	BSB 35-50 DDK-Stecker 5-pol.	Standard	7S9SK043510043A11
	8 m	ED	BSB 35-50 DDK-Stecker 5-pol.	Standard	7S9SK083510043A11
	4 m	ED	BSB 35-50 DDK-Stecker 5-pol.	High Flex Leder	7S9SH043510043A11
	8 m	ED	BSB 35-50 DDK-Stecker 5-pol.	High Flex Leder	7S9SH083510043A11
ABITIG® 24W Little	4 m	ED	BSB 35-50 DDK-Stecker 5-pol.	High Flex Leder	7L9SH043510043A11
	8 m	ED	BSB 35-50 DDK-Stecker 5-pol.	High Flex Leder	7L9SH083510043A11
ABITIG® 450W	4 m	ED	BSB 35-50 DDK-Stecker 5-pol.	Standard	7T5SK043510143A11
	8 m	ED	BSB 35-50 DDK-Stecker 5-pol.	Standard	7T5SK083510143A11
	4 m	ED	BSB 35-50 DDK-Stecker 5-pol.	High Flex Leder	7T5SH043510143A11
	8 m	ED	BSB 35-50 DDK-Stecker 5-pol.	High Flex Leder	7T5SH083510143A11
ABITIG® 260W	4 m	ED	BSB 35-50 DDK-Stecker 5-pol.	Standard	7T7SK043510143A11
	8 m	ED	BSB 35-50 DDK-Stecker 5-pol.	Standard	7T7SK083510143A11
	4 m	ED	BSB 35-50 DDK-Stecker 5-pol.	High Flex Leder	7T7SH043510143A11
	8 m	ED	BSB 35-50 DDK-Stecker 5-pol.	High Flex Leder	7T7SH083510143A11
ABITIG® 260W Little	4 m	ED	BSB 35-50 DDK-Stecker 5-pol.	High Flex Leder	7L7SH043510143A11
	8 m	ED	BSB 35-50 DDK-Stecker 5-pol.	High Flex Leder	7L7SH083510143A11
ABITIG® 450W SC	4 m	ED	BSB 35-50 DDK-Stecker 5-pol.	Standard	
	8 m	ED	BSB 35-50 DDK-Stecker 5-pol.	Standard	
	4 m	ED	BSB 35-50 DDK-Stecker 5-pol.	High Flex Leder	7T8SH043510143A11
	8 m	ED	BSB 35-50 DDK-Stecker 5-pol.	High Flex Leder	7T8SH083510143A11

ABITIG® GRIP / ABITIG® GRIP Little-Brennerpreisliste

passend für WIG-Stromquellen des Fabrikates „cebora“

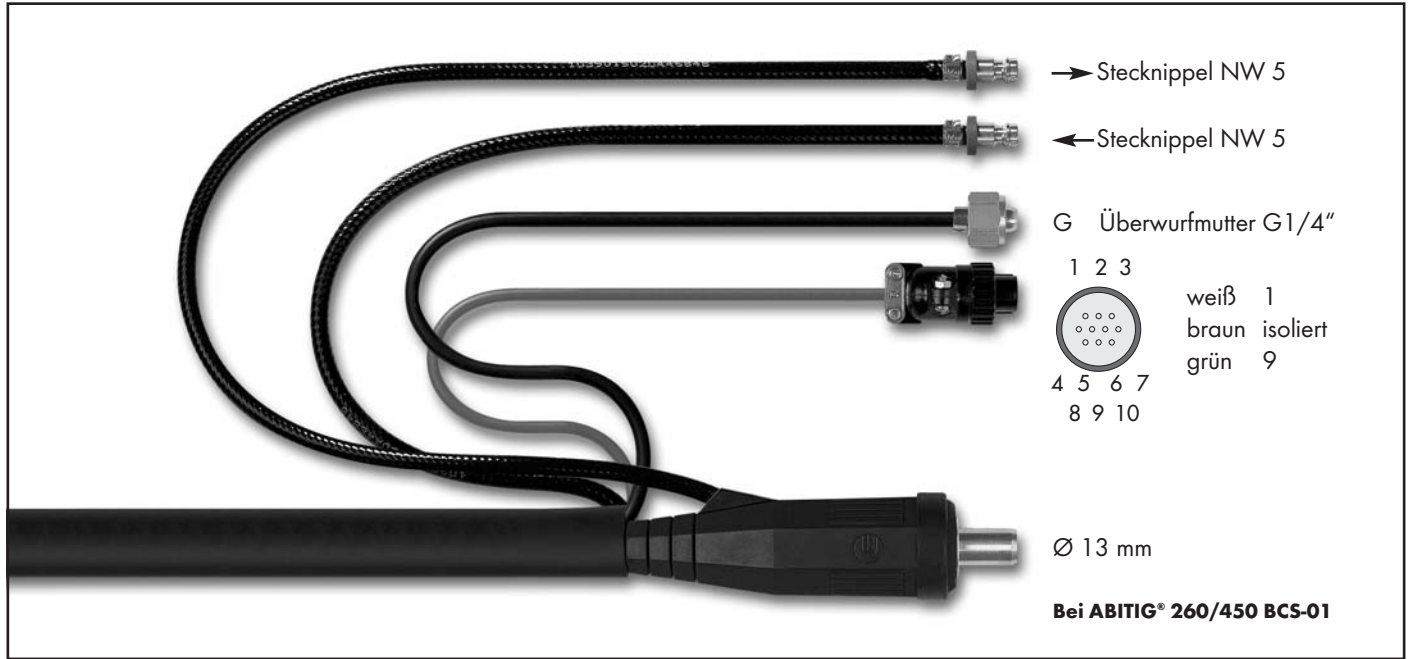

Brennertyp	Länge	Schalterfunktion	maschinenseitiger Anschluss	Schlauchpaketausführung	Bestellnummer
ABITIG® 18	4 m	ED	BSB 35-50 DDK-Stecker 10-pol.	Standard	7S4SK043510043C11
	8 m	ED	BSB 35-50 DDK-Stecker 10-pol.	Standard	7S4SK083510043C11
	4 m	ED	BSB 35-50 DDK-Stecker 10-pol.	High Flex Leder	7S4SH043510043C11
	8 m	ED	BSB 35-50 DDK-Stecker 10-pol.	High Flex Leder	7S4SH083510043C11
ABITIG® 18F	4 m	ED	BSB 35-50 DDK-Stecker 10-pol.	Standard	7S4FK043510043C11
	8 m	ED	BSB 35-50 DDK-Stecker 10-pol.	Standard	7S4FK083510043C11
	4 m	ED	BSB 35-50 DDK-Stecker 10-pol.	High Flex Leder	7S4FH043510043C11
	8 m	ED	BSB 35-50 DDK-Stecker 10-pol.	High Flex Leder	7S4FH083510043C11
ABITIG® 20	4 m	ED	BSB 35-50 DDK-Stecker 10-pol.	Standard	7S5SK043510043C11
	8 m	ED	BSB 35-50 DDK-Stecker 10-pol.	Standard	7S5SK083510043C11
	4 m	ED	BSB 35-50 DDK-Stecker 10-pol.	High Flex Leder	7S5SH043510043C11
	8 m	ED	BSB 35-50 DDK-Stecker 10-pol.	High Flex Leder	7S5SH083510043C11
ABITIG® 20 Little	4 m	ED	BSB 35-50 DDK-Stecker 10-pol.	High Flex Leder	7L5SH043510043C11
	8 m	ED	BSB 35-50 DDK-Stecker 10-pol.	High Flex Leder	7L5SH083510043C11
ABITIG® 20F	4 m	ED	BSB 35-50 DDK-Stecker 10-pol.	Standard	7S5FK043510043C11
	8 m	ED	BSB 35-50 DDK-Stecker 10-pol.	Standard	7S5FK083510043C11
	4 m	ED	BSB 35-50 DDK-Stecker 10-pol.	High Flex Leder	7S5FH043510043C11
	8 m	ED	BSB 35-50 DDK-Stecker 10-pol.	High Flex Leder	7S5FH083510043C11
ABITIG® 20F Little	4 m	ED	BSB 35-50 DDK-Stecker 10-pol.	High Flex Leder	7L5FH043510043C11
	8 m	ED	BSB 35-50 DDK-Stecker 10-pol.	High Flex Leder	7L5FH083510043C11

Technische Änderungen vorbehalten • Verkaufspreise = unverbindliche Preisempfehlung - Angebot freibleibend • © Copyright

ABITIG® GRIP / ABITIG® GRIP Little-Brennerpreisliste

passend für WIG-Stromquellen des Fabrikates „cebora“

Brennertyp	Länge	Schalterfunktion	maschinenseitiger Anschluss	Schlauchpaket-ausführung	Bestellnummer
ABITIG® 12-1	4 m	ED	BSB 35-50 DDK-Stecker 10-pol.	Standard	7S6SK043510043C11
	8 m	ED	BSB 35-50 DDK-Stecker 10-pol.	Standard	7S6SK083510043C11
	4 m	ED	BSB 35-50 DDK-Stecker 10-pol.	High Flex Leder	7S6SH043510043C11
	8 m	ED	BSB 35-50 DDK-Stecker 10-pol.	High Flex Leder	7S6SH083510043C11
<hr/>					
ABITIG® 18SC	4 m	ED	BSB 35-50 DDK-Stecker 10-pol.	Standard	7S7SK043510043C11
	8 m	ED	BSB 35-50 DDK-Stecker 10-pol.	Standard	7S7SK083510043C11
	4 m	ED	BSB 35-50 DDK-Stecker 10-pol.	High Flex Leder	7S7SH043510043C11
	8 m	ED	BSB 35-50 DDK-Stecker 10-pol.	High Flex Leder	7S7SH083510043C11
<hr/>					
ABITIG® 24W	4 m	ED	BSB 35-50 DDK-Stecker 10-pol.	Standard	7S9SK043510043C11
	8 m	ED	BSB 35-50 DDK-Stecker 10-pol.	Standard	7S9SK083510043C11
	4 m	ED	BSB 35-50 DDK-Stecker 10-pol.	High Flex Leder	7S9SH043510043C11
	8 m	ED	BSB 35-50 DDK-Stecker 10-pol.	High Flex Leder	7S9SH083510043C11
ABITIG® 24W Little	4 m	ED	BSB 35-50 DDK-Stecker 10-pol.	High Flex Leder	7L9SH043510043C11
	8 m	ED	BSB 35-50 DDK-Stecker 10-pol.	High Flex Leder	7L9SH083510043C11
<hr/>					
ABITIG® 450W	4 m	ED	BSB 35-50 DDK-Stecker 10-pol.	Standard	7T5SK043510143C11
	8 m	ED	BSB 35-50 DDK-Stecker 10-pol.	Standard	7T5SK083510143C11
	4 m	ED	BSB 35-50 DDK-Stecker 10-pol.	High Flex Leder	7T5SH043510143C11
	8 m	ED	BSB 35-50 DDK-Stecker 10-pol.	High Flex Leder	7T5SH083510143C11
<hr/>					
ABITIG® 260W	4 m	ED	BSB 35-50 DDK-Stecker 10-pol.	Standard	7T7SK043510143C11
	8 m	ED	BSB 35-50 DDK-Stecker 10-pol.	Standard	7T7SK083510143C11
	4 m	ED	BSB 35-50 DDK-Stecker 10-pol.	High Flex Leder	7T7SH043510143C11
	8 m	ED	BSB 35-50 DDK-Stecker 10-pol.	High Flex Leder	7T7SH083510143C11
ABITIG® 260W Little	4 m	ED	BSB 35-50 DDK-Stecker 10-pol.	High Flex Leder	7L7SH043510143C11
	4 m	ED	BSB 35-50 DDK-Stecker 10-pol.	High Flex Leder	7L7SH043510143C11
<hr/>					
ABITIG® 450W SC	4 m	ED	BSB 35-50 DDK-Stecker 10-pol.	Standard	
	8 m	ED	BSB 35-50 DDK-Stecker 10-pol.	Standard	
	4 m	ED	BSB 35-50 DDK-Stecker 10-pol.	High Flex Leder	7T8SH043510143C11
	8 m	ED	BSB 35-50 DDK-Stecker 10-pol.	High Flex Leder	7T8SH083510143C11

ABITIG® GRIP / ABITIG® GRIP Little-Brennerpreisliste

passend für WIG-Stromquellen des Fabrikates „cebora“ Up/Down

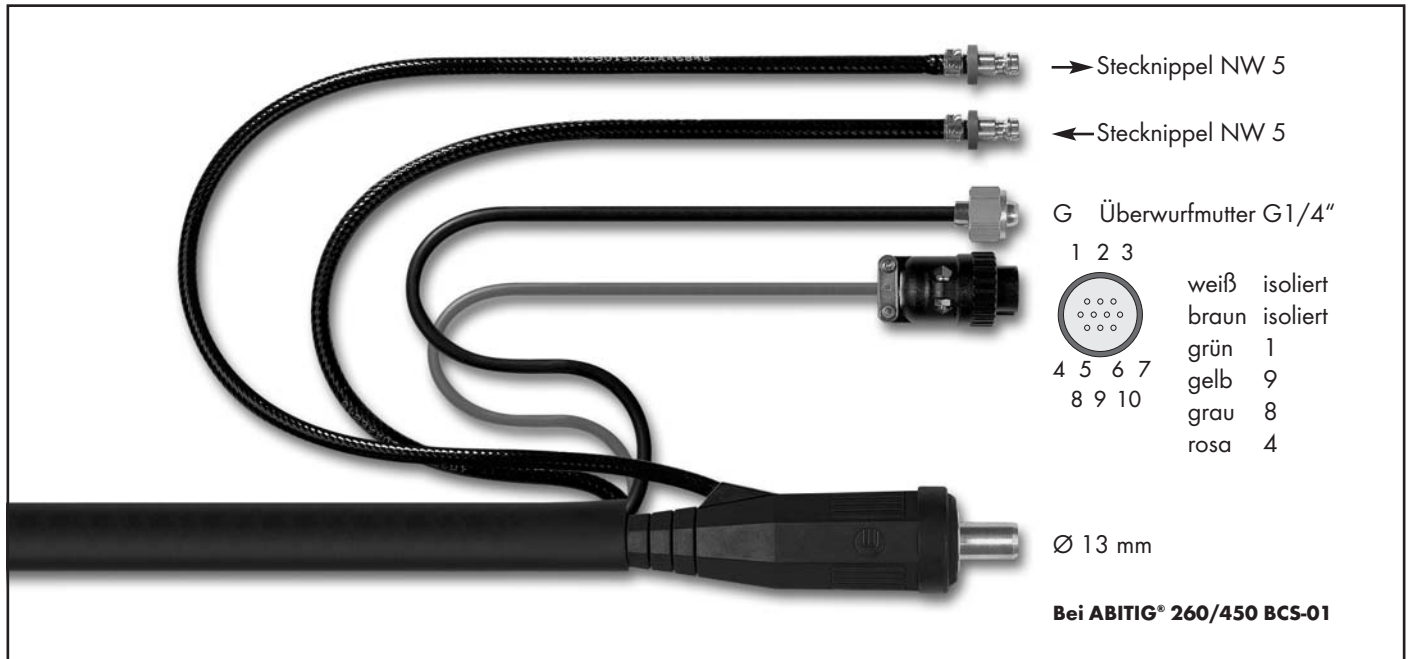

Brennertyp	Länge	Schalterfunktion	maschinenseitiger Anschluss	Schlauchpaketausführung	Bestellnummer
ABITIG® 18	4 m	UD	BSB 35-50 DDK-Stecker 10-pol.	Standard	7S4SK046650043D11
	8 m	UD	BSB 35-50 DDK-Stecker 10-pol.	Standard	7S4SK086650043D11
	4 m	UD	BSB 35-50 DDK-Stecker 10-pol.	High Flex Leder	7S4SH046650043D11
	8 m	UD	BSB 35-50 DDK-Stecker 10-pol.	High Flex Leder	7S4SH086650043D11
ABITIG® 18F	4 m	UD	BSB 35-50 DDK-Stecker 10-pol.	Standard	7S4FK046650043D11
	8 m	UD	BSB 35-50 DDK-Stecker 10-pol.	Standard	7S4FK086650043D11
	4 m	UD	BSB 35-50 DDK-Stecker 10-pol.	High Flex Leder	7S4FH046650043D11
	8 m	UD	BSB 35-50 DDK-Stecker 10-pol.	High Flex Leder	7S4FH086650043D11
ABITIG® 20	4 m	UD	BSB 35-50 DDK-Stecker 10-pol.	Standard	7S5SK046650043D11
	8 m	UD	BSB 35-50 DDK-Stecker 10-pol.	Standard	7S5SK086650043D11
	4 m	UD	BSB 35-50 DDK-Stecker 10-pol.	High Flex Leder	7S5SH046650043D11
	8 m	UD	BSB 35-50 DDK-Stecker 10-pol.	High Flex Leder	7S5SH086650043D11
ABITIG® 20 Little	4 m	UD	BSB 35-50 DDK-Stecker 10-pol.	High Flex Leder	7L5SH046650043D11
	8 m	UD	BSB 35-50 DDK-Stecker 10-pol.	High Flex Leder	7L5SH086650043D11
ABITIG® 20F	4 m	UD	BSB 35-50 DDK-Stecker 10-pol.	Standard	7S5FK046650043D11
	8 m	UD	BSB 35-50 DDK-Stecker 10-pol.	Standard	7S5FK086650043D11
	4 m	UD	BSB 35-50 DDK-Stecker 10-pol.	High Flex Leder	7S5FH046650043D11
	8 m	UD	BSB 35-50 DDK-Stecker 10-pol.	High Flex Leder	7S5FH086650043D11
ABITIG® 20F Little	4 m	UD	BSB 35-50 DDK-Stecker 10-pol.	High Flex Leder	7L5FH046650043D11
	8 m	UD	BSB 35-50 DDK-Stecker 10-pol.	High Flex Leder	7L5FH086650043D11

Technische Änderungen vorbehalten • Verkaufspreise = unverbindliche Preisempfehlung - Angebot freibleibend • © Copyright

ABITIG® GRIP / ABITIG® GRIP Little-Brennerpreisliste

passend für WIG-Stromquellen des Fabrikates „cebora“ Up/Down

Brennertyp	Länge	Schalterfunktion	maschinenseitiger Anschluss	Schlauchpaketausführung	Bestellnummer
ABITIG® 12-1	4 m	UD	BSB 35-50 DDK-Stecker 10-pol.	Standard	7S6SK046650043D11
	8 m	UD	BSB 35-50 DDK-Stecker 10-pol.	Standard	7S6SK086650043D11
	4 m	UD	BSB 35-50 DDK-Stecker 10-pol.	High Flex Leder	7S6SH046650043D11
	8 m	UD	BSB 35-50 DDK-Stecker 10-pol.	High Flex Leder	7S6SH086650043D11
ABITIG® 18SC	4 m	UD	BSB 35-50 DDK-Stecker 10-pol.	Standard	7S7SK046650043D11
	8 m	UD	BSB 35-50 DDK-Stecker 10-pol.	Standard	7S7SK086650043D11
	4 m	UD	BSB 35-50 DDK-Stecker 10-pol.	High Flex Leder	7S7SH046650043D11
	8 m	UD	BSB 35-50 DDK-Stecker 10-pol.	High Flex Leder	7S7SH086650043D11
ABITIG® 24W	4 m	UD	BSB 35-50 DDK-Stecker 10-pol.	Standard	7S9SK046650043D11
	8 m	UD	BSB 35-50 DDK-Stecker 10-pol.	Standard	7S9SK086650043D11
	4 m	UD	BSB 35-50 DDK-Stecker 10-pol.	High Flex Leder	7S9SH046650043D11
	8 m	UD	BSB 35-50 DDK-Stecker 10-pol.	High Flex Leder	7S9SH086650043D11
ABITIG® 24W Little	4 m	UD	BSB 35-50 DDK-Stecker 10-pol.	High Flex Leder	7L9SH046650043D11
	8 m	UD	BSB 35-50 DDK-Stecker 10-pol.	High Flex Leder	7L9SH086650043D11
ABITIG® 450W	4 m	UD	BSB 35-50 DDK-Stecker 10-pol.	Standard	7T5SK046650143D11
	8 m	UD	BSB 35-50 DDK-Stecker 10-pol.	Standard	7T5SK086650143D11
	4 m	UD	BSB 35-50 DDK-Stecker 10-pol.	High Flex Leder	7T5SH046650143D11
	8 m	UD	BSB 35-50 DDK-Stecker 10-pol.	High Flex Leder	7T5SH086650143D11
ABITIG® 260W	4 m	UD	BSB 35-50 DDK-Stecker 10-pol.	Standard	7T7SK046650143D11
	8 m	UD	BSB 35-50 DDK-Stecker 10-pol.	Standard	7T7SK086650143D11
	4 m	UD	BSB 35-50 DDK-Stecker 10-pol.	High Flex Leder	7T7SH046650143D11
	8 m	UD	BSB 35-50 DDK-Stecker 10-pol.	High Flex Leder	7T7SH086650143D11
ABITIG® 260W Little	4 m	UD	BSB 35-50 DDK-Stecker 10-pol.	High Flex Leder	7L7SH046650143D11
	8 m	UD	BSB 35-50 DDK-Stecker 10-pol.	High Flex Leder	7L7SH086650143D11
ABITIG® 450W SC	4 m	UD	BSB 35-50 DDK-Stecker 10-pol.	Standard	
	8 m	UD	BSB 35-50 DDK-Stecker 10-pol.	Standard	
	4 m	UD	BSB 35-50 DDK-Stecker 10-pol.	High Flex Leder	7T8SH046650143D11
	8 m	UD	BSB 35-50 DDK-Stecker 10-pol.	High Flex Leder	7T8SH086650143D11

ABITIG® GRIP / ABITIG® GRIP Little-Brennerpreisliste

passend für WIG-Stromquellen des Fabrikates „cebor“

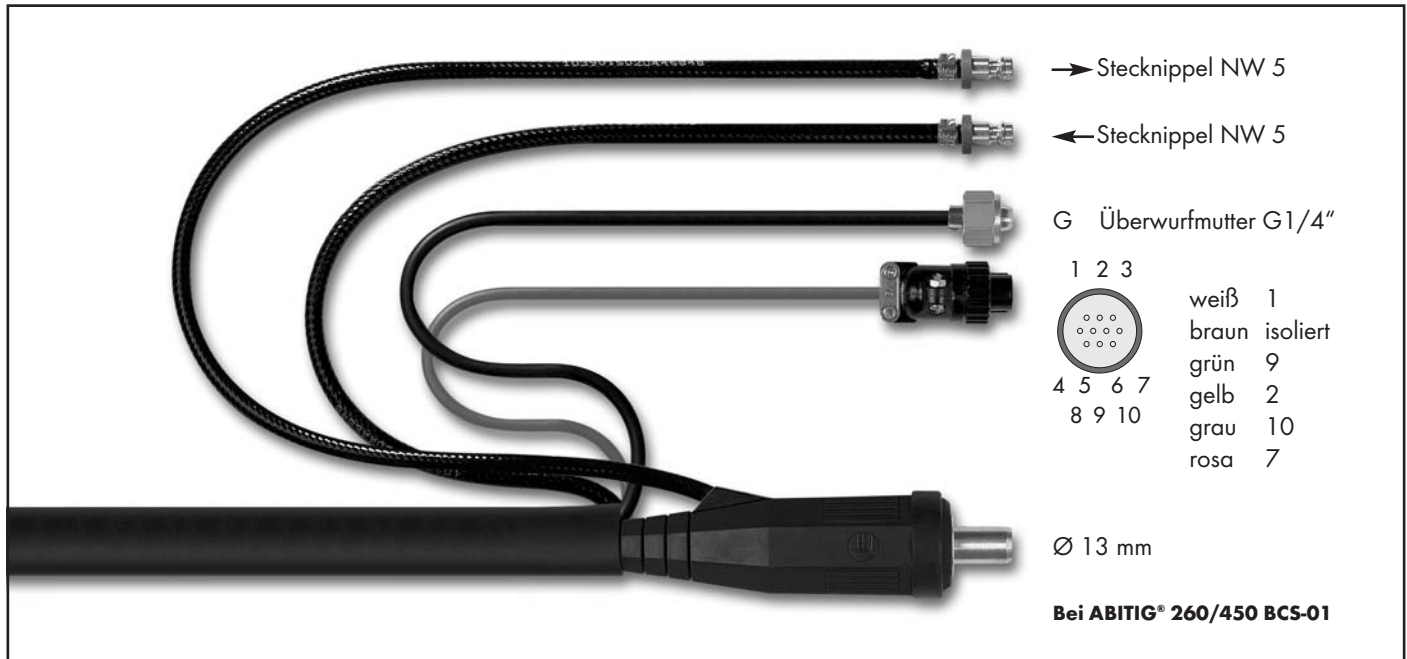

Brennertyp	Länge	Schalterfunktion	maschinenseitiger Anschluss	Schlauchpaketausführung	Bestellnummer
ABITIG® 18	4 m	EDP	BSB 35-50 DDK-Stecker 10-pol.	Standard	7S4SK046540043B11
	8 m	EDP	BSB 35-50 DDK-Stecker 10-pol.	Standard	7S4SK086540043B11
	4 m	EDP	BSB 35-50 DDK-Stecker 10-pol.	High Flex Leder	7S4SH046540043B11
	8 m	EDP	BSB 35-50 DDK-Stecker 10-pol.	High Flex Leder	7S4SH086540043B11
ABITIG® 18F	4 m	EDP	BSB 35-50 DDK-Stecker 10-pol.	Standard	7S4FK046540043B11
	8 m	EDP	BSB 35-50 DDK-Stecker 10-pol.	Standard	7S4FK086540043B11
	4 m	EDP	BSB 35-50 DDK-Stecker 10-pol.	High Flex Leder	7S4FH046540043B11
	8 m	EDP	BSB 35-50 DDK-Stecker 10-pol.	High Flex Leder	7S4FH086540043B11
ABITIG® 20	4 m	EDP	BSB 35-50 DDK-Stecker 10-pol.	Standard	7S5SK046540043B11
	8 m	EDP	BSB 35-50 DDK-Stecker 10-pol.	Standard	7S5SK086540043B11
	4 m	EDP	BSB 35-50 DDK-Stecker 10-pol.	High Flex Leder	7S5SH046540043B11
	8 m	EDP	BSB 35-50 DDK-Stecker 10-pol.	High Flex Leder	7S5SH086540043B11
ABITIG® 20F	4 m	EDP	BSB 35-50 DDK-Stecker 10-pol.	Standard	7S5FK046540043B11
	8 m	EDP	BSB 35-50 DDK-Stecker 10-pol.	Standard	7S5FK086540043B11
	4 m	EDP	BSB 35-50 DDK-Stecker 10-pol.	High Flex Leder	7S5FH046540043B11
	8 m	EDP	BSB 35-50 DDK-Stecker 10-pol.	High Flex Leder	7S5FH086540043B11

Technische Änderungen vorbehalten • Verkaufspreise = unverbindliche Preisempfehlung - Angebot freibleibend • © Copyright

ABITIG® GRIP / ABITIG® GRIP Little-Brennerpreisliste

passend für WIG-Stromquellen des Fabrikates „cebora“

Brennertyp	Länge	Schalterfunktion	maschinenseitiger Anschluss	Schlauchpaketausführung	Bestellnummer
ABITIG® 12-1	4 m	EDP	BSB 35-50 DDK-Stecker 10-pol.	Standard	7S6SK046540043B11
	8 m	EDP	BSB 35-50 DDK-Stecker 10-pol.	Standard	7S6SK086540043B11
	4 m	EDP	BSB 35-50 DDK-Stecker 10-pol.	High Flex Leder	7S6SH046540043B11
	8 m	EDP	BSB 35-50 DDK-Stecker 10-pol.	High Flex Leder	7S6SH086540043B11

ABITIG® 18SC	4 m	EDP	BSB 35-50 DDK-Stecker 10-pol.	Standard	7S7SK046540043B11
	8 m	EDP	BSB 35-50 DDK-Stecker 10-pol.	Standard	7S7SK086540043B11
	4 m	EDP	BSB 35-50 DDK-Stecker 10-pol.	High Flex Leder	7S7SH046540043B11
	8 m	EDP	BSB 35-50 DDK-Stecker 10-pol.	High Flex Leder	7S7SH086540043B11

ABITIG® 24W	4 m	EDP	BSB 35-50 DDK-Stecker 10-pol.	Standard	7S9SK046540043B11
	8 m	EDP	BSB 35-50 DDK-Stecker 10-pol.	Standard	7S9SK086540043B11
	4 m	EDP	BSB 35-50 DDK-Stecker 10-pol.	High Flex Leder	7S9SH046540043B11
	8 m	EDP	BSB 35-50 DDK-Stecker 10-pol.	High Flex Leder	7S9SH086540043B11

ABITIG® 450W	4 m	EDP	BSB 35-50 DDK-Stecker 10-pol.	Standard	7T5SK046540143B11
	8 m	EDP	BSB 35-50 DDK-Stecker 10-pol.	Standard	7T5SK086540143B11
	4 m	EDP	BSB 35-50 DDK-Stecker 10-pol.	High Flex Leder	7T5SH046540143B11
	8 m	EDP	BSB 35-50 DDK-Stecker 10-pol.	High Flex Leder	7T5SH086540143B11

ABITIG® 260W	4 m	EDP	BSB 35-50 DDK-Stecker 10-pol.	Standard	7T7SK046540143B11
	8 m	EDP	BSB 35-50 DDK-Stecker 10-pol.	Standard	7T7SK086540143B11
	4 m	EDP	BSB 35-50 DDK-Stecker 10-pol.	High Flex Leder	7T7SH046540143B11
	8 m	EDP	BSB 35-50 DDK-Stecker 10-pol.	High Flex Leder	7T7SH086540143B11

ABITIG® 450W SC	4 m	EDP	BSB 35-50 DDK-Stecker 10-pol.	Standard	
	8 m	EDP	BSB 35-50 DDK-Stecker 10-pol.	Standard	
	4 m	EDP	BSB 35-50 DDK-Stecker 10-pol.	High Flex Leder	7T8SH046540143B11
	8 m	EDP	BSB 35-50 DDK-Stecker 10-pol.	High Flex Leder	7T8SH086540143B11

ABITIG® GRIP / ABITIG® GRIP Little-Brennerpreisliste

passend für WIG-Stromquellen des Fabrikates „cloos“



Brennertyp	Länge	Schalterfunktion	maschinenseitiger Anschluss	Schlauchpaketausführung	Bestellnummer
ABITIG® 9	4 m	DD	cloos Tuchel 3-pol.	Standard	7S1SK043520513A00
	8 m	DD	cloos Tuchel 3-pol.	Standard	7S1SK083520513A00
	4 m	DD	cloos Tuchel 3-pol.	High Flex Leder	7S1SH043520513A00
	8 m	DD	cloos Tuchel 3-pol.	High Flex Leder	7S1SH083520513A00
ABITIG® 9 Little	4 m	DD	cloos Tuchel 3-pol.	High Flex Leder	7L1SH043520513A00
	8 m	DD	cloos Tuchel 3-pol.	High Flex Leder	7L1SH083520513A00
ABITIG® 9F	4 m	DD	cloos Tuchel 3-pol.	Standard	7S1FK043520513A00
	8 m	DD	cloos Tuchel 3-pol.	Standard	7S1FK083520513A00
	4 m	DD	cloos Tuchel 3-pol.	High Flex Leder	7S1FH043520513A00
	8 m	DD	cloos Tuchel 3-pol.	High Flex Leder	7S1FH083520513A00
ABITIG® 9F Little	4 m	DD	cloos Tuchel 3-pol.	High Flex Leder	7L1FH043520513A00
	8 m	DD	cloos Tuchel 3-pol.	High Flex Leder	7L1FH083520513A00
ABITIG® 17	4 m	DD	cloos Tuchel 3-pol.	Standard	7S2SK043520513A00
	8 m	DD	cloos Tuchel 3-pol.	Standard	7S2SK083520513A00
	4 m	DD	cloos Tuchel 3-pol.	High Flex Leder	7S2SH043520513A00
	8 m	DD	cloos Tuchel 3-pol.	High Flex Leder	7S2SH083520513A00
ABITIG® 17 Little	4 m	DD	cloos Tuchel 3-pol.	High Flex Leder	7L2SH043520513A00
	8 m	DD	cloos Tuchel 3-pol.	High Flex Leder	7L2SH083520513A00
ABITIG® 17F	4 m	DD	cloos Tuchel 3-pol.	Standard	7S2FK043520513A00
	8 m	DD	cloos Tuchel 3-pol.	Standard	7S2FK083520513A00
	4 m	DD	cloos Tuchel 3-pol.	High Flex Leder	7S2FH043520513A00
	8 m	DD	cloos Tuchel 3-pol.	High Flex Leder	7S2FH083520513A00
ABITIG® 17F Little	4 m	DD	cloos Tuchel 3-pol.	High Flex Leder	7L2FH043520513A00
	8 m	DD	cloos Tuchel 3-pol.	High Flex Leder	7L2FH083520513A00

Technische Änderungen vorbehalten • Verkaufspreise = unverbindliche Preisempfehlung - Angebot freibleibend • © Copyright

ABITIG® GRIP / ABITIG® GRIP Little-Brennerpreisliste

passend für WIG-Stromquellen des Fabrikates „cloos“

Brennertyp	Länge	Schalterfunktion	maschinenseitiger Anschluss	Schlauchpaketausführung	Bestellnummer
ABITIG® 26	4 m	DD	cloos Tuchel 3-pol.	Standard	7S3SK043520513A00
	8 m	DD	cloos Tuchel 3-pol.	Standard	7S3SK083520513A00
	4 m	DD	cloos Tuchel 3-pol.	High Flex Leder	7S3SH043520513A00
	8 m	DD	cloos Tuchel 3-pol.	High Flex Leder	7S3SH083520513A00
ABITIG® 26F	4 m	DD	cloos Tuchel 3-pol.	Standard	7S3FK043520513A00
	8 m	DD	cloos Tuchel 3-pol.	Standard	7S3FK083520513A00
	4 m	DD	cloos Tuchel 3-pol.	High Flex Leder	7S3FH043520513A00
	8 m	DD	cloos Tuchel 3-pol.	High Flex Leder	7S3FH083520513A00
ABITIG® 24G	4 m	DD	cloos Tuchel 3-pol.	Standard	7S8SK043520513A00
	8 m	DD	cloos Tuchel 3-pol.	Standard	7S8SK083520513A00
	4 m	DD	cloos Tuchel 3-pol.	High Flex Leder	7S8SH043520513A00
	8 m	DD	cloos Tuchel 3-pol.	High Flex Leder	7S8SH083520513A00
ABITIG® 24G Little	4 m	DD	cloos Tuchel 3-pol.	High Flex Leder	7L8SH043520513A00
	8 m	DD	cloos Tuchel 3-pol.	High Flex Leder	7L8SH083520513A00
ABITIG® 200	4 m	DD	cloos Tuchel 3-pol.	Standard	7T4SK043520513A00
	8 m	DD	cloos Tuchel 3-pol.	Standard	7T4SK083520513A00
	4 m	DD	cloos Tuchel 3-pol.	High Flex Leder	7T4SH043520513A00
	8 m	DD	cloos Tuchel 3-pol.	High Flex Leder	7T4SH083520513A00
ABITIG® 200F	4 m	DD	cloos Tuchel 3-pol.	Standard	7T4FK043520513A00
	8 m	DD	cloos Tuchel 3-pol.	Standard	7T4FK083520513A00
	4 m	DD	cloos Tuchel 3-pol.	High Flex Leder	7T4FH043520513A00
	8 m	DD	cloos Tuchel 3-pol.	High Flex Leder	7T4FH083520513A00
ABITIG® 150	4 m	DD	cloos Tuchel 3-pol.	Standard	7T6SK043520513A00
	8 m	DD	cloos Tuchel 3-pol.	Standard	7T6SK083520513A00
	4 m	DD	cloos Tuchel 3-pol.	High Flex Leder	7T6SH043520513A00
	8 m	DD	cloos Tuchel 3-pol.	High Flex Leder	7T6SH083520513A00
ABITIG® 150 Little	4 m	DD	cloos Tuchel 3-pol.	High Flex Leder	7L6SH043520513A00
	8 m	DD	cloos Tuchel 3-pol.	High Flex Leder	7L6SH083520513A00
ABITIG® 150F	4 m	DD	cloos Tuchel 3-pol.	Standard	7T6FK043520513A00
	8 m	DD	cloos Tuchel 3-pol.	Standard	7T6FK083520513A00
	4 m	DD	cloos Tuchel 3-pol.	High Flex Leder	7T6FH043520513A00
	8 m	DD	cloos Tuchel 3-pol.	High Flex Leder	7T6FH083520513A00
ABITIG® 150F Little	4 m	DD	cloos Tuchel 3-pol.	High Flex Leder	7L6FH043520513A00
	8 m	DD	cloos Tuchel 3-pol.	High Flex Leder	7L6FH083520513A00

ABITIG® GRIP / ABITIG® GRIP Little-Brennerpreisliste

passend für WIG-Stromquellen des Fabrikates „cloos“



Brennertyp	Länge	Schalterfunktion	maschinenseitiger Anschluss	Schlauchpaketausführung	Bestellnummer
ABITIG® 9	4 m	ED	cloos Tuchel 3-pol.	Standard	7S1SK043510513C00
	8 m	ED	cloos Tuchel 3-pol.	Standard	7S1SK083510513C00
	4 m	ED	cloos Tuchel 3-pol.	High Flex Leder	7S1SH043510513C00
	8 m	ED	cloos Tuchel 3-pol.	High Flex Leder	7S1SH083510513C00
ABITIG® 9 Little	4 m	ED	cloos Tuchel 3-pol.	High Flex Leder	7L1SH043510513C00
	8 m	ED	cloos Tuchel 3-pol.	High Flex Leder	7L1SH083510513C00
ABITIG® 9F	4 m	ED	cloos Tuchel 3-pol.	Standard	7S1FK043510513C00
	8 m	ED	cloos Tuchel 3-pol.	Standard	7S1FK083510513C00
	4 m	ED	cloos Tuchel 3-pol.	High Flex Leder	7S1FH043510513C00
	8 m	ED	cloos Tuchel 3-pol.	High Flex Leder	7S1FH083510513C00
ABITIG® 9F Little	4 m	ED	cloos Tuchel 3-pol.	High Flex Leder	7L1FH043510513C00
	8 m	ED	cloos Tuchel 3-pol.	High Flex Leder	7L1FH083510513C00
ABITIG® 17	4 m	ED	cloos Tuchel 3-pol.	Standard	7S2SK043510513C00
	8 m	ED	cloos Tuchel 3-pol.	Standard	7S2SK083510513C00
	4 m	ED	cloos Tuchel 3-pol.	High Flex Leder	7S2SH043510513C00
	8 m	ED	cloos Tuchel 3-pol.	High Flex Leder	7S2SH083510513C00
ABITIG® 17 Little	4 m	ED	cloos Tuchel 3-pol.	High Flex Leder	7L2SH043510513C00
	8 m	ED	cloos Tuchel 3-pol.	High Flex Leder	7L2SH083510513C00
ABITIG® 17F	4 m	ED	cloos Tuchel 3-pol.	Standard	7S2FK043510513C00
	8 m	ED	cloos Tuchel 3-pol.	Standard	7S2FK083510513C00
	4 m	ED	cloos Tuchel 3-pol.	High Flex Leder	7S2FH043510513C00
	8 m	ED	cloos Tuchel 3-pol.	High Flex Leder	7S2FH083510513C00
ABITIG® 17F Little	4 m	ED	cloos Tuchel 3-pol.	High Flex Leder	7L2FH043510513C00
	8 m	ED	cloos Tuchel 3-pol.	High Flex Leder	7L2FH083510513C00

Technische Änderungen vorbehalten • Verkaufspreise = unverbindliche Preisempfehlung - Angebot freibleibend • © Copyright

ABITIG® GRIP / ABITIG® GRIP Little-Brennerpreisliste

passend für WIG-Stromquellen des Fabrikates „cloos“

Brennertyp	Länge	Schalterfunktion	maschinenseitiger Anschluss	Schlauchpaket-ausführung	Bestellnummer
ABITIG® 26	4 m	ED	cloos Tuchel 3-pol.	Standard	7S3SK043510513C00
	8 m	ED	cloos Tuchel 3-pol.	Standard	7S3SK083510513C00
	4 m	ED	cloos Tuchel 3-pol.	High Flex Leder	7S3SH043510513C00
	8 m	ED	cloos Tuchel 3-pol.	High Flex Leder	7S3SH083510513C00
ABITIG® 26F	4 m	ED	cloos Tuchel 3-pol.	Standard	7S3FK043510513C00
	8 m	ED	cloos Tuchel 3-pol.	Standard	7S3FK083510513C00
	4 m	ED	cloos Tuchel 3-pol.	High Flex Leder	7S3FH043510513C00
	8 m	ED	cloos Tuchel 3-pol.	High Flex Leder	7S3FH083510513C00
ABITIG® 24G	4 m	ED	cloos Tuchel 3-pol.	Standard	7S8SK043510513C00
	8 m	ED	cloos Tuchel 3-pol.	Standard	7S8SK083510513C00
	4 m	ED	cloos Tuchel 3-pol.	High Flex Leder	7S8SH043510513C00
	8 m	ED	cloos Tuchel 3-pol.	High Flex Leder	7S8SH083510513C00
ABITIG® 24G Little	4 m	ED	cloos Tuchel 3-pol.	High Flex Leder	7L8SH043510513C00
	8 m	ED	cloos Tuchel 3-pol.	High Flex Leder	7L8SH083510513C00
ABITIG® 200	4 m	ED	cloos Tuchel 3-pol.	Standard	7T4SK043510513C00
	8 m	ED	cloos Tuchel 3-pol.	Standard	7T4SK083510513C00
	4 m	ED	cloos Tuchel 3-pol.	High Flex Leder	7T4SH043510513C00
	8 m	ED	cloos Tuchel 3-pol.	High Flex Leder	7T4SH083510513C00
ABITIG® 200F	4 m	ED	cloos Tuchel 3-pol.	Standard	7T4FK043510513C00
	8 m	ED	cloos Tuchel 3-pol.	Standard	7T4FK083510513C00
	4 m	ED	cloos Tuchel 3-pol.	High Flex Leder	7T4FH043510513C00
	8 m	ED	cloos Tuchel 3-pol.	High Flex Leder	7T4FH083510513C00
ABITIG® 150	4 m	ED	cloos Tuchel 3-pol.	Standard	7T6SK043510513C00
	8 m	ED	cloos Tuchel 3-pol.	Standard	7T6SK083510513C00
	4 m	ED	cloos Tuchel 3-pol.	High Flex Leder	7T6SH043510513C00
	8 m	ED	cloos Tuchel 3-pol.	High Flex Leder	7T6SH083510513C00
ABITIG® 150 Little	4 m	ED	cloos Tuchel 3-pol.	High Flex Leder	7L6SH043510513C00
	8 m	ED	cloos Tuchel 3-pol.	High Flex Leder	7L6SH083510513C00
ABITIG® 150F	4 m	ED	cloos Tuchel 3-pol.	Standard	7T6FK043510513C00
	8 m	ED	cloos Tuchel 3-pol.	Standard	7T6FK083510513C00
	4 m	ED	cloos Tuchel 3-pol.	High Flex Leder	7T6FH043510513C00
	8 m	ED	cloos Tuchel 3-pol.	High Flex Leder	7T6FH083510513C00
ABITIG® 150F Little	4 m	ED	cloos Tuchel 3-pol.	High Flex Leder	7L6FH043510513C00
	8 m	ED	cloos Tuchel 3-pol.	High Flex Leder	7L6FH083510513C00

ABITIG® GRIP / ABITIG® GRIP Little-Brennerpreisliste

passend für WIG-Stromquellen des Fabrikates „cloos“

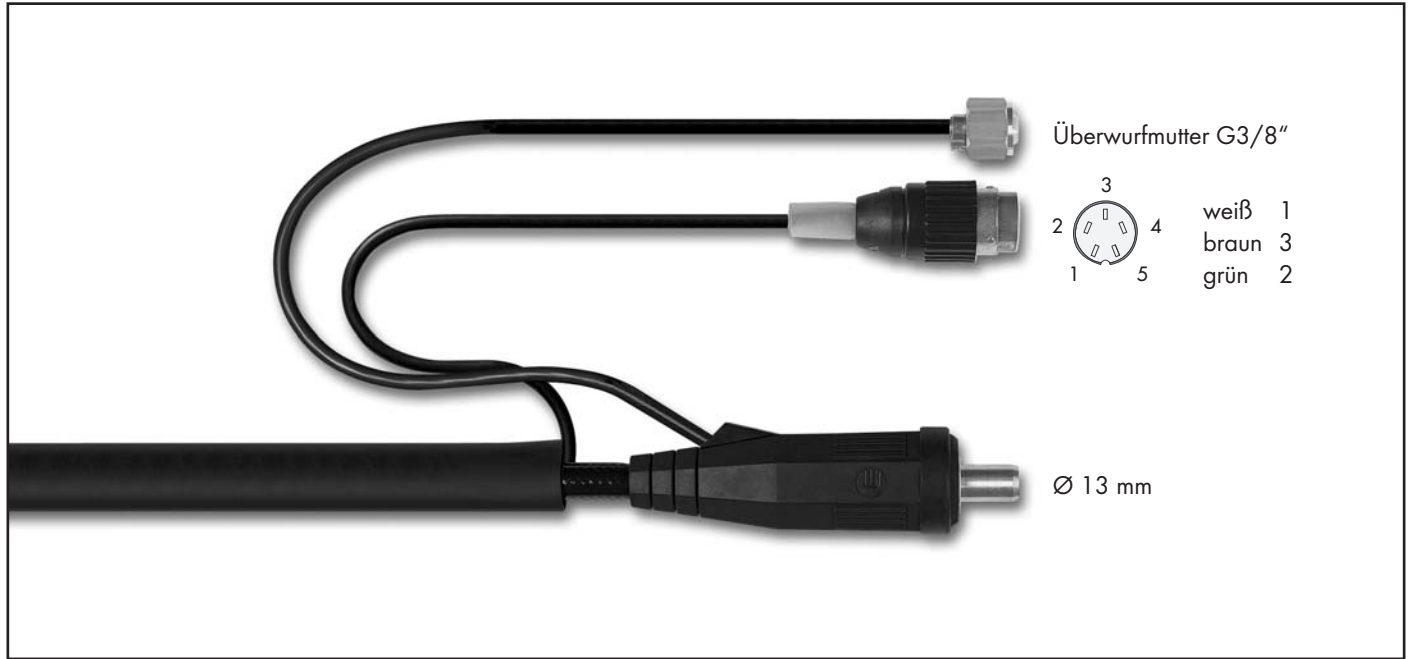

Brennertyp	Länge	Schalterfunktion	maschinenseitiger Anschluss	Schlauchpaketausführung	Bestellnummer
ABITIG® 9	4 m	ED/DD	BSB 35-50 Tuchel 5-pol.	Standard	7S1SK043520001B02
	8 m	ED/DD	BSB 35-50 Tuchel 5-pol.	Standard	7S1SK083520001B02
	4 m	ED/DD	BSB 35-50 Tuchel 5-pol.	High Flex Leder	7S1SH043520001B02
	8 m	ED/DD	BSB 35-50 Tuchel 5-pol.	High Flex Leder	7S1SH083520001B02
ABITIG® 9 Little	4 m	ED/DD	BSB 35-50 Tuchel 5-pol.	High Flex Leder	7L1SH043520001B02
	8 m	ED/DD	BSB 35-50 Tuchel 5-pol.	High Flex Leder	7L1SH083520001B02
ABITIG® 9F	4 m	ED/DD	BSB 35-50 Tuchel 5-pol.	Standard	7S1FK043520001B02
	8 m	ED/DD	BSB 35-50 Tuchel 5-pol.	Standard	7S1FK083520001B02
	4 m	ED/DD	BSB 35-50 Tuchel 5-pol.	High Flex Leder	7S1FH043520001B02
	8 m	ED/DD	BSB 35-50 Tuchel 5-pol.	High Flex Leder	7S1FH083520001B02
ABITIG® 9F Little	4 m	ED/DD	BSB 35-50 Tuchel 5-pol.	High Flex Leder	7L1FH043520001B02
	8 m	ED/DD	BSB 35-50 Tuchel 5-pol.	High Flex Leder	7L1FH083520001B02
ABITIG® 17	4 m	ED/DD	BSB 35-50 Tuchel 5-pol.	Standard	7S2SK043520001B02
	8 m	ED/DD	BSB 35-50 Tuchel 5-pol.	Standard	7S2SK083520001B02
	4 m	ED/DD	BSB 35-50 Tuchel 5-pol.	High Flex Leder	7S2SH043520001B02
	8 m	ED/DD	BSB 35-50 Tuchel 5-pol.	High Flex Leder	7S2SH083520001B02
ABITIG® 17 Little	4 m	ED/DD	BSB 35-50 Tuchel 5-pol.	High Flex Leder	7L2SH043520001B02
	8 m	ED/DD	BSB 35-50 Tuchel 5-pol.	High Flex Leder	7L2SH083520001B02
ABITIG® 17F	4 m	ED/DD	BSB 35-50 Tuchel 5-pol.	Standard	7S2FK043520001B02
	8 m	ED/DD	BSB 35-50 Tuchel 5-pol.	Standard	7S2FK083520001B02
	4 m	ED/DD	BSB 35-50 Tuchel 5-pol.	High Flex Leder	7S2FH043520001B02
	8 m	ED/DD	BSB 35-50 Tuchel 5-pol.	High Flex Leder	7S2FH083520001B02
ABITIG® 17F Little	4 m	ED/DD	BSB 35-50 Tuchel 5-pol.	High Flex Leder	7L2FH043520001B02
	8 m	ED/DD	BSB 35-50 Tuchel 5-pol.	High Flex Leder	7L2FH083520001B02

Technische Änderungen vorbehalten • Verkaufspreise = unverbindliche Preisempfehlung - Angebot freibleibend • © Copyright

ABITIG® GRIP / ABITIG® GRIP Little-Brennerpreisliste

passend für WIG-Stromquellen des Fabrikates „cloos“

Brennertyp	Länge	Schalterfunktion	maschinenseitiger Anschluss	Schlauchpaketausführung	Bestellnummer
ABITIG® 26	4 m	ED/DD	BSB 35-50 Tuchel 5-pol.	Standard	7S3SK043520001B02
	8 m	ED/DD	BSB 35-50 Tuchel 5-pol.	Standard	7S3SK083520001B02
	4 m	ED/DD	BSB 35-50 Tuchel 5-pol.	High Flex Leder	7S3SH043520001B02
	8 m	ED/DD	BSB 35-50 Tuchel 5-pol.	High Flex Leder	7S3SH083520001B02
ABITIG® 26F	4 m	ED/DD	BSB 35-50 Tuchel 5-pol.	Standard	7S3FK043520001B02
	8 m	ED/DD	BSB 35-50 Tuchel 5-pol.	Standard	7S3FK083520001B02
	4 m	ED/DD	BSB 35-50 Tuchel 5-pol.	High Flex Leder	7S3FH043520001B02
	8 m	ED/DD	BSB 35-50 Tuchel 5-pol.	High Flex Leder	7S3FH083520001B02
ABITIG® 24G	4 m	ED/DD	BSB 35-50 Tuchel 5-pol.	Standard	7S8SK043520001B02
	8 m	ED/DD	BSB 35-50 Tuchel 5-pol.	Standard	7S8SK083520001B02
	4 m	ED/DD	BSB 35-50 Tuchel 5-pol.	High Flex Leder	7S8SH043520001B02
	8 m	ED/DD	BSB 35-50 Tuchel 5-pol.	High Flex Leder	7S8SH083520001B02
ABITIG® 24G Little	4 m	ED/DD	BSB 35-50 Tuchel 5-pol.	High Flex Leder	7L8SH043520001B02
	8 m	ED/DD	BSB 35-50 Tuchel 5-pol.	High Flex Leder	7L8SH083520001B02
ABITIG® 200	4 m	ED/DD	BSB 35-50 Tuchel 5-pol.	Standard	7T4SK043520001B02
	8 m	ED/DD	BSB 35-50 Tuchel 5-pol.	Standard	7T4SK083520001B02
	4 m	ED/DD	BSB 35-50 Tuchel 5-pol.	High Flex Leder	7T4SH043520001B02
	8 m	ED/DD	BSB 35-50 Tuchel 5-pol.	High Flex Leder	7T4SH083520001B02
ABITIG® 200F	4 m	ED/DD	BSB 35-50 Tuchel 5-pol.	Standard	7T4FK043520001B02
	8 m	ED/DD	BSB 35-50 Tuchel 5-pol.	Standard	7T4FK083520001B02
	4 m	ED/DD	BSB 35-50 Tuchel 5-pol.	High Flex Leder	7T4FH043520001B02
	8 m	ED/DD	BSB 35-50 Tuchel 5-pol.	High Flex Leder	7T4FH083520001B02
ABITIG® 150	4 m	ED/DD	BSB 35-50 Tuchel 5-pol.	Standard	7T6SK043520001B02
	8 m	ED/DD	BSB 35-50 Tuchel 5-pol.	Standard	7T6SK083520001B02
	4 m	ED/DD	BSB 35-50 Tuchel 5-pol.	High Flex Leder	7T6SH043520001B02
	8 m	ED/DD	BSB 35-50 Tuchel 5-pol.	High Flex Leder	7T6SH083520001B02
ABITIG® 150 Little	4 m	ED/DD	BSB 35-50 Tuchel 5-pol.	High Flex Leder	7L6SH043520001B02
	8 m	ED/DD	BSB 35-50 Tuchel 5-pol.	High Flex Leder	7L6SH083520001B02
ABITIG® 150F	4 m	ED/DD	BSB 35-50 Tuchel 5-pol.	Standard	7T6FK043520001B02
	8 m	ED/DD	BSB 35-50 Tuchel 5-pol.	Standard	7T6FK083520001B02
	4 m	ED/DD	BSB 35-50 Tuchel 5-pol.	High Flex Leder	7T6FH043520001B02
	8 m	ED/DD	BSB 35-50 Tuchel 5-pol.	High Flex Leder	7T6FH083520001B02
ABITIG® 150F Little	4 m	ED/DD	BSB 35-50 Tuchel 5-pol.	High Flex Leder	7L6FH043520001B02
	8 m	ED/DD	BSB 35-50 Tuchel 5-pol.	High Flex Leder	7L6FH083520001B02

ABITIG® GRIP / ABITIG® GRIP Little-Brennerpreisliste

passend für WIG-Stromquellen des Fabrikates „cloos“

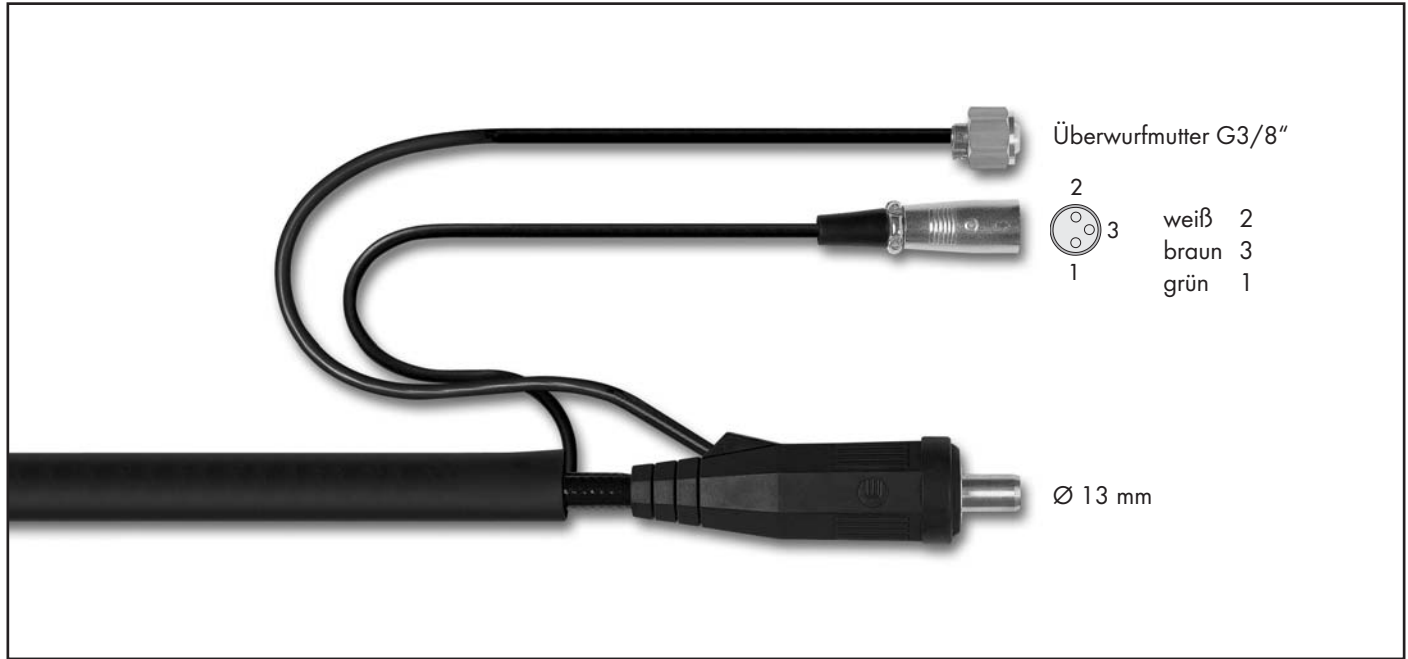

Brennertyp	Länge	Schalterfunktion	maschinenseitiger Anschluss	Schlauchpaketausführung	Bestellnummer
ABITIG® 9	4 m	ED/DD	BSB 35-50 Rundsteckverb. 3-pol.	Standard	7S1SK043520041A02
	8 m	ED/DD	BSB 35-50 Rundsteckverb. 3-pol.	Standard	7S1SK083520041A02
	4 m	ED/DD	BSB 35-50 Rundsteckverb. 3-pol.	High Flex Leder	7S1SH043520041A02
	8 m	ED/DD	BSB 35-50 Rundsteckverb. 3-pol.	High Flex Leder	7S1SH083520041A02
ABITIG® 9 Little	4 m	ED/DD	BSB 35-50 Rundsteckverb. 3-pol.	High Flex Leder	7L1SH043520041A02
	8 m	ED/DD	BSB 35-50 Rundsteckverb. 3-pol.	High Flex Leder	7L1SH083520041A02
ABITIG® 9F	4 m	ED/DD	BSB 35-50 Rundsteckverb. 3-pol.	Standard	7S1FK043520041A02
	8 m	ED/DD	BSB 35-50 Rundsteckverb. 3-pol.	Standard	7S1FK083520041A02
	4 m	ED/DD	BSB 35-50 Rundsteckverb. 3-pol.	High Flex Leder	7S1FH043520041A02
	8 m	ED/DD	BSB 35-50 Rundsteckverb. 3-pol.	High Flex Leder	7S1FH083520041A02
ABITIG® 9F Little	4 m	ED/DD	BSB 35-50 Rundsteckverb. 3-pol.	High Flex Leder	7L1FH043520041A02
	8 m	ED/DD	BSB 35-50 Rundsteckverb. 3-pol.	High Flex Leder	7L1FH083520041A02
ABITIG® 17	4 m	ED/DD	BSB 35-50 Rundsteckverb. 3-pol.	Standard	7S2SK043520041A02
	8 m	ED/DD	BSB 35-50 Rundsteckverb. 3-pol.	Standard	7S2SK083520041A02
	4 m	ED/DD	BSB 35-50 Rundsteckverb. 3-pol.	High Flex Leder	7S2SH043520041A02
	8 m	ED/DD	BSB 35-50 Rundsteckverb. 3-pol.	High Flex Leder	7S2SH083520041A02
ABITIG® 17 Little	4 m	ED/DD	BSB 35-50 Rundsteckverb. 3-pol.	High Flex Leder	7L2SH043520041A02
	8 m	ED/DD	BSB 35-50 Rundsteckverb. 3-pol.	High Flex Leder	7L2SH083520041A02
ABITIG® 17F	4 m	ED/DD	BSB 35-50 Rundsteckverb. 3-pol.	Standard	7S2FK043520041A02
	8 m	ED/DD	BSB 35-50 Rundsteckverb. 3-pol.	Standard	7S2FK083520041A02
	4 m	ED/DD	BSB 35-50 Rundsteckverb. 3-pol.	High Flex Leder	7S2FH043520041A02
	8 m	ED/DD	BSB 35-50 Rundsteckverb. 3-pol.	High Flex Leder	7S2FH083520041A02
ABITIG® 17F Little	4 m	ED/DD	BSB 35-50 Rundsteckverb. 3-pol.	High Flex Leder	7L2FH043520041A02
	8 m	ED/DD	BSB 35-50 Rundsteckverb. 3-pol.	High Flex Leder	7L2FH083520041A02

Technische Änderungen vorbehalten • Verkaufspreise = unverbindliche Preisempfehlung - Angebot freibleibend • © Copyright

ABITIG® GRIP / ABITIG® GRIP Little-Brennerpreisliste

passend für WIG-Stromquellen des Fabrikates „cloos“

Brennertyp	Länge	Schalterfunktion	maschinenseitiger Anschluss	Schlauchpaketausführung	Bestellnummer
ABITIG® 26	4 m	ED/DD	BSB 35-50 Rundsteckverb. 3-pol.	Standard	7S3SK043520041A02
	8 m	ED/DD	BSB 35-50 Rundsteckverb. 3-pol.	Standard	7S3SK083520041A02
	4 m	ED/DD	BSB 35-50 Rundsteckverb. 3-pol.	High Flex Leder	7S3SH043520041A02
	8 m	ED/DD	BSB 35-50 Rundsteckverb. 3-pol.	High Flex Leder	7S3SH083520041A02
ABITIG® 26F	4 m	ED/DD	BSB 35-50 Rundsteckverb. 3-pol.	Standard	7S3FK043520041A02
	8 m	ED/DD	BSB 35-50 Rundsteckverb. 3-pol.	Standard	7S3FK083520041A02
	4 m	ED/DD	BSB 35-50 Rundsteckverb. 3-pol.	High Flex Leder	7S3FH043520041A02
	8 m	ED/DD	BSB 35-50 Rundsteckverb. 3-pol.	High Flex Leder	7S3FH083520041A02
ABITIG® 24G	4 m	ED/DD	BSB 35-50 Rundsteckverb. 3-pol.	Standard	7S8SK043520041A02
	8 m	ED/DD	BSB 35-50 Rundsteckverb. 3-pol.	Standard	7S8SK083520041A02
	4 m	ED/DD	BSB 35-50 Rundsteckverb. 3-pol.	High Flex Leder	7S8SH043520041A02
	8 m	ED/DD	BSB 35-50 Rundsteckverb. 3-pol.	High Flex Leder	7S8SH083520041A02
ABITIG® 24G Little	4 m	ED/DD	BSB 35-50 Rundsteckverb. 3-pol.	High Flex Leder	7L8SH043520041A02
	8 m	ED/DD	BSB 35-50 Rundsteckverb. 3-pol.	High Flex Leder	7L8SH083520041A02
ABITIG® 200	4 m	ED/DD	BSB 35-50 Rundsteckverb. 3-pol.	Standard	7T4SK043520041A02
	8 m	ED/DD	BSB 35-50 Rundsteckverb. 3-pol.	Standard	7T4SK083520041A02
	4 m	ED/DD	BSB 35-50 Rundsteckverb. 3-pol.	High Flex Leder	7T4SH043520041A02
	8 m	ED/DD	BSB 35-50 Rundsteckverb. 3-pol.	High Flex Leder	7T4SH083520041A02
ABITIG® 200F	4 m	ED/DD	BSB 35-50 Rundsteckverb. 3-pol.	Standard	7T4FK043520041A02
	8 m	ED/DD	BSB 35-50 Rundsteckverb. 3-pol.	Standard	7T4FK083520041A02
	4 m	ED/DD	BSB 35-50 Rundsteckverb. 3-pol.	High Flex Leder	7T4FH043520041A02
	8 m	ED/DD	BSB 35-50 Rundsteckverb. 3-pol.	High Flex Leder	7T4FH083520041A02
ABITIG® 150	4 m	ED/DD	BSB 35-50 Rundsteckverb. 3-pol.	Standard	7T6SK043520041A02
	8 m	ED/DD	BSB 35-50 Rundsteckverb. 3-pol.	Standard	7T6SK083520041A02
	4 m	ED/DD	BSB 35-50 Rundsteckverb. 3-pol.	High Flex Leder	7T6SH043520041A02
	8 m	ED/DD	BSB 35-50 Rundsteckverb. 3-pol.	High Flex Leder	7T6SH083520041A02
ABITIG® 150 Little	4 m	ED/DD	BSB 35-50 Rundsteckverb. 3-pol.	High Flex Leder	7L6SH043520041A02
	8 m	ED/DD	BSB 35-50 Rundsteckverb. 3-pol.	High Flex Leder	7L6SH083520041A02
ABITIG® 150F	4 m	ED/DD	BSB 35-50 Rundsteckverb. 3-pol.	Standard	7T6FK043520041A02
	8 m	ED/DD	BSB 35-50 Rundsteckverb. 3-pol.	Standard	7T6FK083520041A02
	4 m	ED/DD	BSB 35-50 Rundsteckverb. 3-pol.	High Flex Leder	7T6FH043520041A02
	8 m	ED/DD	BSB 35-50 Rundsteckverb. 3-pol.	High Flex Leder	7T6FH083520041A02
ABITIG® 150F Little	4 m	ED/DD	BSB 35-50 Rundsteckverb. 3-pol.	High Flex Leder	7L6FH043520041A02
	8 m	ED/DD	BSB 35-50 Rundsteckverb. 3-pol.	High Flex Leder	7L6FH083520041A02

ABITIG® GRIP / ABITIG® GRIP Little-Brennerpreisliste

passend für WIG-Stromquellen des Fabrikates „cloos“



Brennertyp	Länge	Schalterfunktion	maschinenseitiger Anschluss	Schlauchpaketausführung	Bestellnummer
ABITIG® 9	4 m	ED	MAG - ZA	Standard	7S1SK043513496A00
	8 m	ED	MAG - ZA	Standard	7S1SK083513496A00
	4 m	ED	MAG - ZA	High Flex Leder	7S1SH043513496A00
	8 m	ED	MAG - ZA	High Flex Leder	7S1SH083513496A00
ABITIG® 9 Little	4 m	ED	MAG - ZA	High Flex Leder	7L1SH043513496A00
	8 m	ED	MAG - ZA	High Flex Leder	7L1SH083513496A00
ABITIG® 9F	4 m	ED	MAG - ZA	Standard	7S1FK043513496A00
	8 m	ED	MAG - ZA	Standard	7S1FK083513496A00
	4 m	ED	MAG - ZA	High Flex Leder	7S1FH043513496A00
	8 m	ED	MAG - ZA	High Flex Leder	7S1FH083513496A00
ABITIG® 9F Little	4 m	ED	MAG - ZA	High Flex Leder	7L1FH043513496A00
	8 m	ED	MAG - ZA	High Flex Leder	7L1FH083513496A00
ABITIG® 17	4 m	ED	MAG - ZA	Standard	7S2SK043513496A00
	8 m	ED	MAG - ZA	Standard	7S2SK083513496A00
	4 m	ED	MAG - ZA	High Flex Leder	7S2SH043513496A00
	8 m	ED	MAG - ZA	High Flex Leder	7S2SH083513496A00
ABITIG® 17 Little	4 m	ED	MAG - ZA	High Flex Leder	7L2SH043513496A00
	8 m	ED	MAG - ZA	High Flex Leder	7L2SH083513496A00
ABITIG® 17F	4 m	ED	MAG - ZA	Standard	7S2FK043513496A00
	8 m	ED	MAG - ZA	Standard	7S2FK083513496A00
	4 m	ED	MAG - ZA	High Flex Leder	7S2FH043513496A00
	8 m	ED	MAG - ZA	High Flex Leder	7S2FH083513496A00
ABITIG® 17F Little	4 m	ED	MAG - ZA	High Flex Leder	7L2FH043513496A00
	8 m	ED	MAG - ZA	High Flex Leder	7L2FH083513496A00

Technische Änderungen vorbehalten • Verkaufspreise = unverbindliche Preisempfehlung - Angebot freibleibend • © Copyright

ABITIG® GRIP / ABITIG® GRIP Little-Brennerpreisliste

passend für WIG-Stromquellen des Fabrikates „cloos“

Brennertyp	Länge	Schalterfunktion	maschinenseitiger Anschluss	Schlauchpaketausführung	Bestellnummer
ABITIG® 26	4 m	ED	MAG - ZA	Standard	7S3SK043513496A00
	8 m	ED	MAG - ZA	Standard	7S3SK083513496A00
	4 m	ED	MAG - ZA	High Flex Leder	7S3SH043513496A00
	8 m	ED	MAG - ZA	High Flex Leder	7S3SH083513496A00
ABITIG® 26F	4 m	ED	MAG - ZA	Standard	7S3FK043513496A00
	8 m	ED	MAG - ZA	Standard	7S3FK083513496A00
	4 m	ED	MAG - ZA	High Flex Leder	7S3FH043513496A00
	8 m	ED	MAG - ZA	High Flex Leder	7S3FH083513496A00
ABITIG® 24G	4 m	ED	MAG - ZA	Standard	7S8SK043513496A00
	8 m	ED	MAG - ZA	Standard	7S8SK083513496A00
	4 m	ED	MAG - ZA	High Flex Leder	7S8SH043513496A00
	8 m	ED	MAG - ZA	High Flex Leder	7S8SH083513496A00
ABITIG® 24G Little	4 m	ED	MAG - ZA	High Flex Leder	7L8SH043513496A00
	8 m	ED	MAG - ZA	High Flex Leder	7L8SH083513496A00
ABITIG® 200	4 m	ED	MAG - ZA	Standard	7T4SK043513496A00
	8 m	ED	MAG - ZA	Standard	7T4SK083513496A00
	4 m	ED	MAG - ZA	High Flex Leder	7T4SH043513496A00
	8 m	ED	MAG - ZA	High Flex Leder	7T4SH083513496A00
ABITIG® 200F	4 m	ED	MAG - ZA	Standard	7T4FK043513496A00
	8 m	ED	MAG - ZA	Standard	7T4FK083513496A00
	4 m	ED	MAG - ZA	High Flex Leder	7T4FH043513496A00
	8 m	ED	MAG - ZA	High Flex Leder	7T4FH083513496A00
ABITIG® 150	4 m	ED	MAG - ZA	Standard	7T6SK043513496A00
	8 m	ED	MAG - ZA	Standard	7T6SK083513496A00
	4 m	ED	MAG - ZA	High Flex Leder	7T6SH043513496A00
	8 m	ED	MAG - ZA	High Flex Leder	7T6SH083513496A00
ABITIG® 150 Little	4 m	ED	MAG - ZA	High Flex Leder	7L6SH043513496A00
	8 m	ED	MAG - ZA	High Flex Leder	7L6SH083513496A00
ABITIG® 150F	4 m	ED	MAG - ZA	Standard	7T6FK043513496A00
	8 m	ED	MAG - ZA	Standard	7T6FK083513496A00
	4 m	ED	MAG - ZA	High Flex Leder	7T6FH043513496A00
	8 m	ED	MAG - ZA	High Flex Leder	7T6FH083513496A00
ABITIG® 150F Little	4 m	ED	MAG - ZA	High Flex Leder	7L6FH043513496A00
	8 m	ED	MAG - ZA	High Flex Leder	7L6FH083513496A00

ABITIG® GRIP / ABITIG® GRIP Little-Brennerpreisliste

passend für WIG-Stromquellen des Fabrikates „cloos“



Brennertyp	Länge	Schalterfunktion	maschinenseitiger Anschluss	Schlauchpaketausführung	Bestellnummer
ABITIG® 18	4 m	DD	cloos Tuchel 3-pol.	Standard	7S4SK043520513A13
	8 m	DD	cloos Tuchel 3-pol.	Standard	7S4SK083520513A13
	4 m	DD	cloos Tuchel 3-pol.	High Flex Leder	7S4SH043520513A13
	8 m	DD	cloos Tuchel 3-pol.	High Flex Leder	7S4SH083520513A13
ABITIG® 18F	4 m	DD	cloos Tuchel 3-pol.	Standard	7S4FK043520513A13
	8 m	DD	cloos Tuchel 3-pol.	Standard	7S4FK083520513A13
	4 m	DD	cloos Tuchel 3-pol.	High Flex Leder	7S4FH043520513A13
	8 m	DD	cloos Tuchel 3-pol.	High Flex Leder	7S4FH083520513A13
ABITIG® 20	4 m	DD	cloos Tuchel 3-pol.	Standard	7S5SK043520513A13
	8 m	DD	cloos Tuchel 3-pol.	Standard	7S5SK083520513A13
	4 m	DD	cloos Tuchel 3-pol.	High Flex Leder	7S5SH043520513A13
	8 m	DD	cloos Tuchel 3-pol.	High Flex Leder	7S5SH083520513A13
ABITIG® 20 Little	4 m	DD	cloos Tuchel 3-pol.	High Flex Leder	7L5SH043520513A13
	8 m	DD	cloos Tuchel 3-pol.	High Flex Leder	7L5SH083520513A13
ABITIG® 20F	4 m	DD	cloos Tuchel 3-pol.	Standard	7S5FK043520513A13
	8 m	DD	cloos Tuchel 3-pol.	Standard	7S5FK083520513A13
	4 m	DD	cloos Tuchel 3-pol.	High Flex Leder	7S5FH043520513A13
	8 m	DD	cloos Tuchel 3-pol.	High Flex Leder	7S5FH083520513A13
ABITIG® 20F Little	4 m	DD	cloos Tuchel 3-pol.	High Flex Leder	7L5FH043520513A13
	8 m	DD	cloos Tuchel 3-pol.	High Flex Leder	7L5FH083520513A13

Technische Änderungen vorbehalten • Verkaufspreise = unverbindliche Preisempfehlung - Angebot freibleibend • © Copyright

ABITIG® GRIP / ABITIG® GRIP Little-Brennerpreisliste

passend für WIG-Stromquellen des Fabrikates „cloos“

Brennertyp	Länge	Schalterfunktion	maschinenseitiger Anschluss	Schlauchpaketausführung	Bestellnummer
ABITIG® 12-1	4 m	DD	cloos Tuchel 3-pol.	Standard	7S6SK043520513A13
	8 m	DD	cloos Tuchel 3-pol.	Standard	7S6SK083520513A13
	4 m	DD	cloos Tuchel 3-pol.	High Flex Leder	7S6SH043520513A13
	8 m	DD	cloos Tuchel 3-pol.	High Flex Leder	7S6SH083520513A13
ABITIG® 18SC	4 m	DD	cloos Tuchel 3-pol.	Standard	7S7SK043520513A13
	8 m	DD	cloos Tuchel 3-pol.	Standard	7S7SK083520513A13
	4 m	DD	cloos Tuchel 3-pol.	High Flex Leder	7S7SH043520513A13
	8 m	DD	cloos Tuchel 3-pol.	High Flex Leder	7S7SH083520513A13
ABITIG® 24W	4 m	DD	cloos Tuchel 3-pol.	Standard	7S9SK043520513A13
	8 m	DD	cloos Tuchel 3-pol.	Standard	7S9SK083520513A13
	4 m	DD	cloos Tuchel 3-pol.	High Flex Leder	7S9SH043520513A13
	8 m	DD	cloos Tuchel 3-pol.	High Flex Leder	7S9SH083520513A13
ABITIG® 24W Little	4 m	DD	cloos Tuchel 3-pol.	High Flex Leder	7L9SH043520513A13
	8 m	DD	cloos Tuchel 3-pol.	High Flex Leder	7L9SH083520513A13
ABITIG® 450W	4 m	DD	cloos Tuchel 3-pol.	Standard	7T5SK043520513A13
	8 m	DD	cloos Tuchel 3-pol.	Standard	7T5SK083520513A13
	4 m	DD	cloos Tuchel 3-pol.	High Flex Leder	7T5SH043520513A13
	8 m	DD	cloos Tuchel 3-pol.	High Flex Leder	7T5SH083520513A13
ABITIG® 260W	4 m	DD	cloos Tuchel 3-pol.	Standard	7T7SK043520513A13
	8 m	DD	cloos Tuchel 3-pol.	Standard	7T7SK083520513A13
	4 m	DD	cloos Tuchel 3-pol.	High Flex Leder	7T7SH043520513A13
	8 m	DD	cloos Tuchel 3-pol.	High Flex Leder	7T7SH083520513A13
ABITIG® 260W Little	4 m	DD	cloos Tuchel 3-pol.	High Flex Leder	7L7SH043520513A13
	8 m	DD	cloos Tuchel 3-pol.	High Flex Leder	7L7SH083520513A13
ABITIG® 450W SC	4 m	DD	cloos Tuchel 3-pol.	Standard	
	8 m	DD	cloos Tuchel 3-pol.	Standard	
	4 m	DD	cloos Tuchel 3-pol.	High Flex Leder	7T8SH043520513A13
	8 m	DD	cloos Tuchel 3-pol.	High Flex Leder	7T8SH083520513A13

ABITIG® GRIP / ABITIG® GRIP Little-Brennerpreisliste

passend für WIG-Stromquellen des Fabrikates „cloos“



Brennertyp	Länge	Schalterfunktion	maschinenseitiger Anschluss	Schlauchpaketausführung	Bestellnummer
ABITIG® 18	4 m	ED	cloos Tuchel 3-pol.	Standard	7S4SK043510513C13
	8 m	ED	cloos Tuchel 3-pol.	Standard	7S4SK083510513C13
	4 m	ED	cloos Tuchel 3-pol.	High Flex Leder	7S4SH043510513C13
	8 m	ED	cloos Tuchel 3-pol.	High Flex Leder	7S4SH083510513C13
ABITIG® 18F	4 m	ED	cloos Tuchel 3-pol.	Standard	7S4FK043510513C13
	8 m	ED	cloos Tuchel 3-pol.	Standard	7S4FK083510513C13
	4 m	ED	cloos Tuchel 3-pol.	High Flex Leder	7S4FH043510513C13
	8 m	ED	cloos Tuchel 3-pol.	High Flex Leder	7S4FH083510513C13
ABITIG® 20	4 m	ED	cloos Tuchel 3-pol.	Standard	7S5SK043510513C13
	8 m	ED	cloos Tuchel 3-pol.	Standard	7S5SK083510513C13
	4 m	ED	cloos Tuchel 3-pol.	High Flex Leder	7S5SH043510513C13
	8 m	ED	cloos Tuchel 3-pol.	High Flex Leder	7S5SH083510513C13
ABITIG® 20 Little	4 m	ED	cloos Tuchel 3-pol.	High Flex Leder	7L5SH043510513C13
	8 m	ED	cloos Tuchel 3-pol.	High Flex Leder	7L5SH083510513C13
ABITIG® 20F	4 m	ED	cloos Tuchel 3-pol.	Standard	7S5FK043510513C13
	8 m	ED	cloos Tuchel 3-pol.	Standard	7S5FK083510513C13
	4 m	ED	cloos Tuchel 3-pol.	High Flex Leder	7S5FH043510513C13
	8 m	ED	cloos Tuchel 3-pol.	High Flex Leder	7S5FH083510513C13
ABITIG® 20F Little	4 m	ED	cloos Tuchel 3-pol.	High Flex Leder	7L5FH043510513C13
	8 m	ED	cloos Tuchel 3-pol.	High Flex Leder	7L5FH083510513C13

Technische Änderungen vorbehalten • Verkaufspreise = unverbindliche Preisempfehlung - Angebot freibleibend • © Copyright

ABITIG® GRIP / ABITIG® GRIP Little-Brennerpreisliste

passend für WIG-Stromquellen des Fabrikates „cloos“

Brennertyp	Länge	Schalterfunktion	maschinenseitiger Anschluss	Schlauchpaketausführung	Bestellnummer
ABITIG® 12-1	4 m	ED	cloos Tuchel 3-pol.	Standard	7S6SK043510513C13
	8 m	ED	cloos Tuchel 3-pol.	Standard	7S6SK083510513C13
	4 m	ED	cloos Tuchel 3-pol.	High Flex Leder	7S6SH043510513C13
	8 m	ED	cloos Tuchel 3-pol.	High Flex Leder	7S6SH083510513C13
ABITIG® 18SC	4 m	ED	cloos Tuchel 3-pol.	Standard	7S7SK043510513C13
	8 m	ED	cloos Tuchel 3-pol.	Standard	7S7SK083510513C13
	4 m	ED	cloos Tuchel 3-pol.	High Flex Leder	7S7SH043510513C13
	8 m	ED	cloos Tuchel 3-pol.	High Flex Leder	7S7SH083510513C13
ABITIG® 24W	4 m	ED	cloos Tuchel 3-pol.	Standard	7S9SK043510513C13
	8 m	ED	cloos Tuchel 3-pol.	Standard	7S9SK083510513C13
	4 m	ED	cloos Tuchel 3-pol.	High Flex Leder	7S9SH043510513C13
	8 m	ED	cloos Tuchel 3-pol.	High Flex Leder	7S9SH083510513C13
ABITIG® 24W Little	4 m	ED	cloos Tuchel 3-pol.	High Flex Leder	7L9SH043510513C13
	8 m	ED	cloos Tuchel 3-pol.	High Flex Leder	7L9SH083510513C13
ABITIG® 450W	4 m	ED	cloos Tuchel 3-pol.	Standard	7T5SK043510513C13
	8 m	ED	cloos Tuchel 3-pol.	Standard	7T5SK083510513C13
	4 m	ED	cloos Tuchel 3-pol.	High Flex Leder	7T5SH043510513C13
	8 m	ED	cloos Tuchel 3-pol.	High Flex Leder	7T5SH083510513C13
ABITIG® 260W	4 m	ED	cloos Tuchel 3-pol.	Standard	7T7SK043510513C13
	8 m	ED	cloos Tuchel 3-pol.	Standard	7T7SK083510513C13
	4 m	ED	cloos Tuchel 3-pol.	High Flex Leder	7T7SH043510513C13
	8 m	ED	cloos Tuchel 3-pol.	High Flex Leder	7T7SH083510513C13
ABITIG® 260W Little	4 m	ED	cloos Tuchel 3-pol.	High Flex Leder	7L7SH043510513C13
	8 m	ED	cloos Tuchel 3-pol.	High Flex Leder	7L7SH083510513C13
ABITIG® 450W SC	4 m	ED	cloos Tuchel 3-pol.	Standard	
	8 m	ED	cloos Tuchel 3-pol.	Standard	
	4 m	ED	cloos Tuchel 3-pol.	High Flex Leder	7T8SH043510513C13
	8 m	ED	cloos Tuchel 3-pol.	High Flex Leder	7T8SH083510513C13

ABITIG® GRIP / ABITIG® GRIP Little-Brennerpreisliste

passend für WIG-Stromquellen des Fabrikates „cloos“

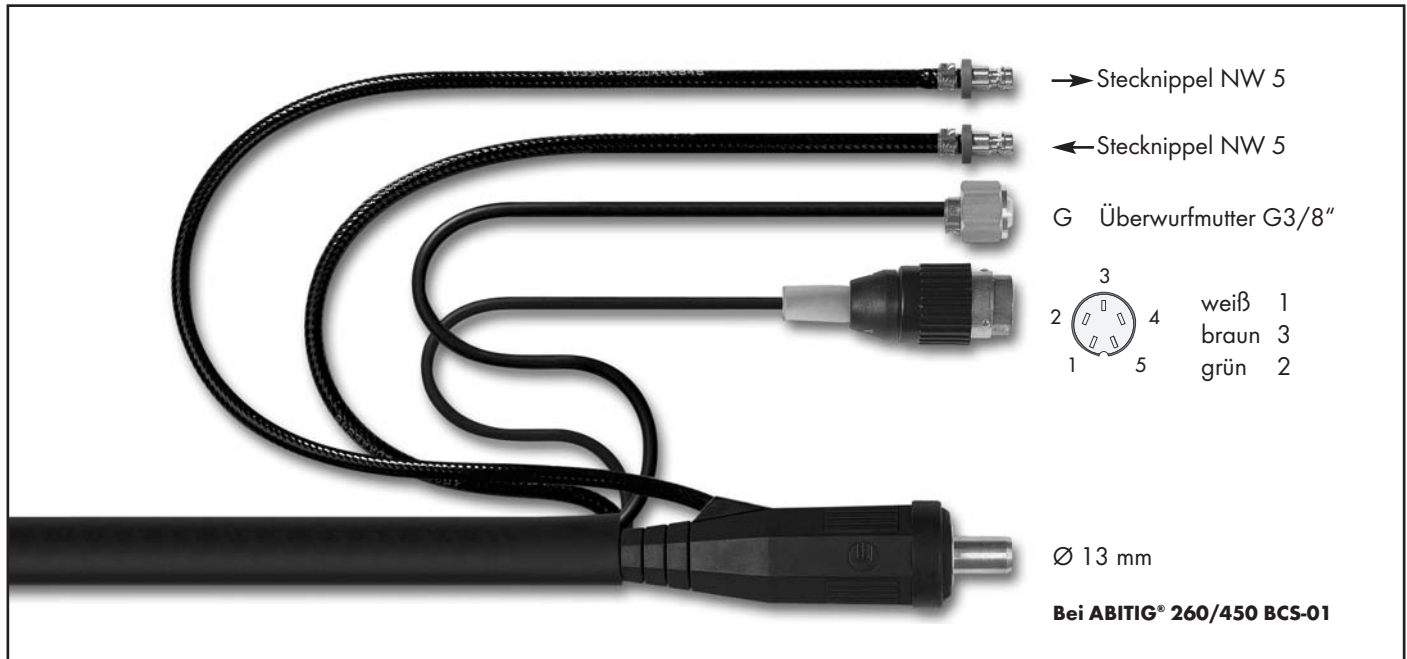

Brennertyp	Länge	Schalterfunktion	maschinenseitiger Anschluss	Schlauchpaketausführung	Bestellnummer
ABITIG® 18	4 m	ED/DD	BSB 35-50 Tuchel 5-pol.	Standard	7S4SK043520001B26
	8 m	ED/DD	BSB 35-50 Tuchel 5-pol.	Standard	7S4SK083520001B26
	4 m	ED/DD	BSB 35-50 Tuchel 5-pol.	High Flex Leder	7S4SH043520001B26
	8 m	ED/DD	BSB 35-50 Tuchel 5-pol.	High Flex Leder	7S4SH083520001B26
ABITIG® 18F	4 m	ED/DD	BSB 35-50 Tuchel 5-pol.	Standard	7S4FK043520001B26
	8 m	ED/DD	BSB 35-50 Tuchel 5-pol.	Standard	7S4FK083520001B26
	4 m	ED/DD	BSB 35-50 Tuchel 5-pol.	High Flex Leder	7S4FH043520001B26
	8 m	ED/DD	BSB 35-50 Tuchel 5-pol.	High Flex Leder	7S4FH083520001B26
ABITIG® 20	4 m	ED/DD	BSB 35-50 Tuchel 5-pol.	Standard	7S5SK043520001B26
	8 m	ED/DD	BSB 35-50 Tuchel 5-pol.	Standard	7S5SK083520001B26
	4 m	ED/DD	BSB 35-50 Tuchel 5-pol.	High Flex Leder	7S5SH043520001B26
	8 m	ED/DD	BSB 35-50 Tuchel 5-pol.	High Flex Leder	7S5SH083520001B26
ABITIG® 20 Little	4 m	ED/DD	BSB 35-50 Tuchel 5-pol.	High Flex Leder	7L5SH043520001B26
	8 m	ED/DD	BSB 35-50 Tuchel 5-pol.	High Flex Leder	7L5SH083520001B26
ABITIG® 20F	4 m	ED/DD	BSB 35-50 Tuchel 5-pol.	Standard	7S5FK043520001B26
	8 m	ED/DD	BSB 35-50 Tuchel 5-pol.	Standard	7S5FK083520001B26
	4 m	ED/DD	BSB 35-50 Tuchel 5-pol.	High Flex Leder	7S5FH043520001B26
	8 m	ED/DD	BSB 35-50 Tuchel 5-pol.	High Flex Leder	7S5FH083520001B26
ABITIG® 20F Little	4 m	ED/DD	BSB 35-50 Tuchel 5-pol.	High Flex Leder	7L5FH043520001B26
	8 m	ED/DD	BSB 35-50 Tuchel 5-pol.	High Flex Leder	7L5FH083520001B26

Technische Änderungen vorbehalten • Verkaufspreise = unverbindliche Preisempfehlung - Angebot freibleibend • © Copyright

ABITIG® GRIP / ABITIG® GRIP Little-Brennerpreisliste

passend für WIG-Stromquellen des Fabrikates „cloos“

Brennertyp	Länge	Schalterfunktion	maschinenseitiger Anschluss	Schlauchpaketausführung	Bestellnummer
ABITIG® 12-1	4 m	ED/DD	BSB 35-50 Tuchel 5-pol.	Standard	7S6SK043520001B26
	8 m	ED/DD	BSB 35-50 Tuchel 5-pol.	Standard	7S6SK083520001B26
	4 m	ED/DD	BSB 35-50 Tuchel 5-pol.	High Flex Leder	7S6SH043520001B26
	8 m	ED/DD	BSB 35-50 Tuchel 5-pol.	High Flex Leder	7S6SH083520001B26
<hr/>					
ABITIG® 18SC	4 m	ED/DD	BSB 35-50 Tuchel 5-pol.	Standard	7S7SK043520001B26
	8 m	ED/DD	BSB 35-50 Tuchel 5-pol.	Standard	7S7SK083520001B26
	4 m	ED/DD	BSB 35-50 Tuchel 5-pol.	High Flex Leder	7S7SH043520001B26
	8 m	ED/DD	BSB 35-50 Tuchel 5-pol.	High Flex Leder	7S7SH083520001B26
<hr/>					
ABITIG® 24W	4 m	ED/DD	BSB 35-50 Tuchel 5-pol.	Standard	7S9SK043520001B26
	8 m	ED/DD	BSB 35-50 Tuchel 5-pol.	Standard	7S9SK083520001B26
	4 m	ED/DD	BSB 35-50 Tuchel 5-pol.	High Flex Leder	7S9SH043520001B26
	8 m	ED/DD	BSB 35-50 Tuchel 5-pol.	High Flex Leder	7S9SH083520001B26
ABITIG® 24W Little	4 m	ED/DD	BSB 35-50 Tuchel 5-pol.	High Flex Leder	7L9SH043520001B26
	8 m	ED/DD	BSB 35-50 Tuchel 5-pol.	High Flex Leder	7L9SH083520001B26
<hr/>					
ABITIG® 450W	4 m	ED/DD	BSB 35-50 Tuchel 5-pol.	Standard	7T5SK043520101B26
	8 m	ED/DD	BSB 35-50 Tuchel 5-pol.	Standard	7T5SK083520101B26
	4 m	ED/DD	BSB 35-50 Tuchel 5-pol.	High Flex Leder	7T5SH043520101B26
	8 m	ED/DD	BSB 35-50 Tuchel 5-pol.	High Flex Leder	7T5SH083520101B26
<hr/>					
ABITIG® 260W	4 m	ED/DD	BSB 35-50 Tuchel 5-pol.	Standard	7T7SK043520101B26
	8 m	ED/DD	BSB 35-50 Tuchel 5-pol.	Standard	7T7SK083520101B26
	4 m	ED/DD	BSB 35-50 Tuchel 5-pol.	High Flex Leder	7T7SH043520101B26
	8 m	ED/DD	BSB 35-50 Tuchel 5-pol.	High Flex Leder	7T7SH083520101B26
ABITIG® 260W Little	4 m	ED/DD	BSB 35-50 Tuchel 5-pol.	High Flex Leder	7L7SH043520101B26
	8 m	ED/DD	BSB 35-50 Tuchel 5-pol.	High Flex Leder	7L7SH083520101B26
<hr/>					
ABITIG® 450W SC	4 m	ED/DD	BSB 35-50 Tuchel 5-pol.	Standard	
	8 m	ED/DD	BSB 35-50 Tuchel 5-pol.	Standard	
	4 m	ED/DD	BSB 35-50 Tuchel 5-pol.	High Flex Leder	7T8SH043520101B26
	8 m	ED/DD	BSB 35-50 Tuchel 5-pol.	High Flex Leder	7T8SH083520101B26
<hr/>					
<hr/>					

ABITIG® GRIP / ABITIG® GRIP Little-Brennerpreisliste

passend für WIG-Stromquellen des Fabrikates „cloos“

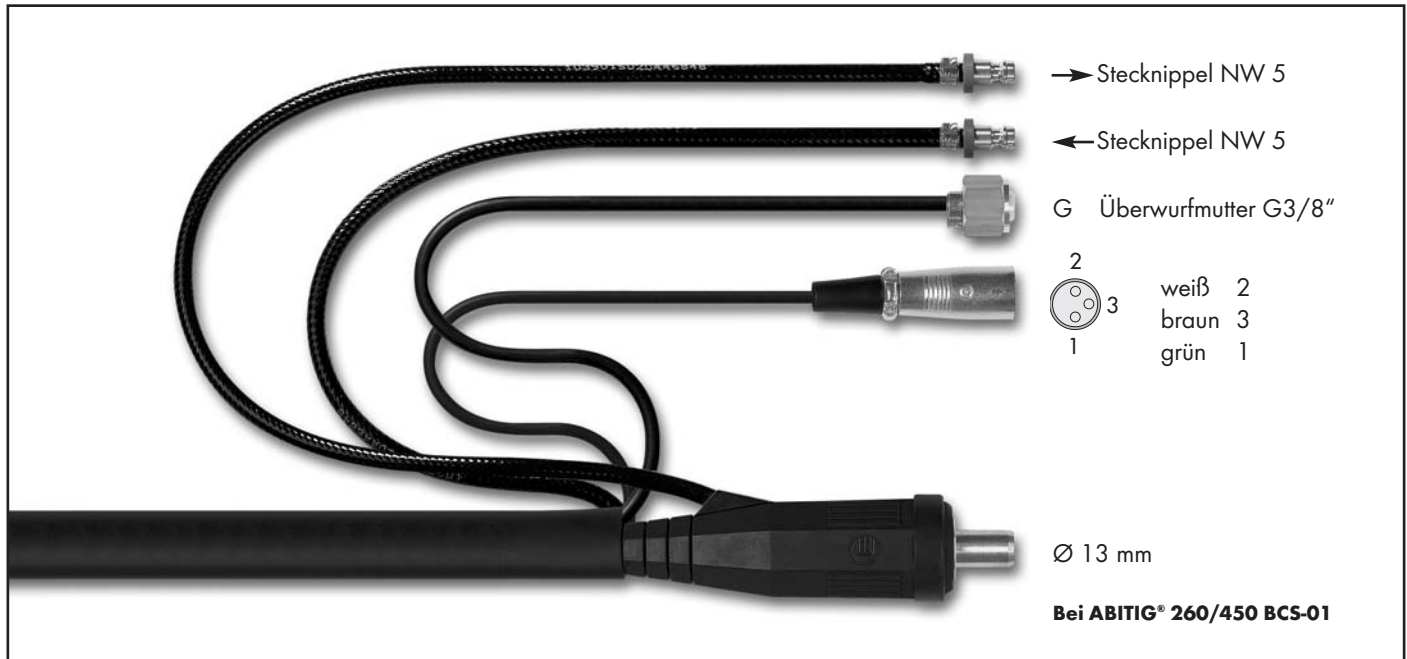

Brennertyp	Länge	Schalterfunktion	maschinenseitiger Anschluss	Schlauchpaketausführung	Bestellnummer
ABITIG® 18	4 m	ED/DD	BSB 35-50 Rundsteckverb. 3-pol.	Standard	7S4SK043520041A26
	8 m	ED/DD	BSB 35-50 Rundsteckverb. 3-pol.	Standard	7S4SK083520041A26
	4 m	ED/DD	BSB 35-50 Rundsteckverb. 3-pol.	High Flex Leder	7S4SH043520041A26
	8 m	ED/DD	BSB 35-50 Rundsteckverb. 3-pol.	High Flex Leder	7S4SH083520041A26
ABITIG® 18F	4 m	ED/DD	BSB 35-50 Rundsteckverb. 3-pol.	Standard	7S4FK043520041A26
	8 m	ED/DD	BSB 35-50 Rundsteckverb. 3-pol.	Standard	7S4FK083520041A26
	4 m	ED/DD	BSB 35-50 Rundsteckverb. 3-pol.	High Flex Leder	7S4FH043520041A26
	8 m	ED/DD	BSB 35-50 Rundsteckverb. 3-pol.	High Flex Leder	7S4FH083520041A26
ABITIG® 20	4 m	ED/DD	BSB 35-50 Rundsteckverb. 3-pol.	Standard	7S5SK043520041A26
	8 m	ED/DD	BSB 35-50 Rundsteckverb. 3-pol.	Standard	7S5SK083520041A26
	4 m	ED/DD	BSB 35-50 Rundsteckverb. 3-pol.	High Flex Leder	7S5SH043520041A26
	8 m	ED/DD	BSB 35-50 Rundsteckverb. 3-pol.	High Flex Leder	7S5SH083520041A26
ABITIG® 20 Little	4 m	ED/DD	BSB 35-50 Rundsteckverb. 3-pol.	High Flex Leder	7L5SH043520041A26
	8 m	ED/DD	BSB 35-50 Rundsteckverb. 3-pol.	High Flex Leder	7L5SH083520041A26
ABITIG® 20F	4 m	ED/DD	BSB 35-50 Rundsteckverb. 3-pol.	Standard	7S5FK043520041A26
	8 m	ED/DD	BSB 35-50 Rundsteckverb. 3-pol.	Standard	7S5FK083520041A26
	4 m	ED/DD	BSB 35-50 Rundsteckverb. 3-pol.	High Flex Leder	7S5FH043520041A26
	8 m	ED/DD	BSB 35-50 Rundsteckverb. 3-pol.	High Flex Leder	7S5FH083520041A26
ABITIG® 20F Little	4 m	ED/DD	BSB 35-50 Rundsteckverb. 3-pol.	High Flex Leder	7L5FH043520041A26
	8 m	ED/DD	BSB 35-50 Rundsteckverb. 3-pol.	High Flex Leder	7L5FH083520041A26

Technische Änderungen vorbehalten • Verkaufspreise = unverbindliche Preisempfehlung - Angebot freibleibend • © Copyright

ABITIG® GRIP / ABITIG® GRIP Little-Brennerpreisliste

passend für WIG-Stromquellen des Fabrikates „cloos“

Brennertyp	Länge	Schalterfunktion	maschinenseitiger Anschluss	Schlauchpaketausführung	Bestellnummer
ABITIG® 12-1	4 m	ED/DD	BSB 35-50 Rundsteckverb. 3-pol.	Standard	7S6SK043520041A26
	8 m	ED/DD	BSB 35-50 Rundsteckverb. 3-pol.	Standard	7S6SK083520041A26
	4 m	ED/DD	BSB 35-50 Rundsteckverb. 3-pol.	High Flex Leder	7S6SH043520041A26
	8 m	ED/DD	BSB 35-50 Rundsteckverb. 3-pol.	High Flex Leder	7S6SH083520041A26
<hr/>					
ABITIG® 18SC	4 m	ED/DD	BSB 35-50 Rundsteckverb. 3-pol.	Standard	7S7SK043520041A26
	8 m	ED/DD	BSB 35-50 Rundsteckverb. 3-pol.	Standard	7S7SK083520041A26
	4 m	ED/DD	BSB 35-50 Rundsteckverb. 3-pol.	High Flex Leder	7S7SH043520041A26
	8 m	ED/DD	BSB 35-50 Rundsteckverb. 3-pol.	High Flex Leder	7S7SH083520041A26
<hr/>					
ABITIG® 24W	4 m	ED/DD	BSB 35-50 Rundsteckverb. 3-pol.	Standard	7S9SK043520041A26
	8 m	ED/DD	BSB 35-50 Rundsteckverb. 3-pol.	Standard	7S9SK083520041A26
	4 m	ED/DD	BSB 35-50 Rundsteckverb. 3-pol.	High Flex Leder	7S9SH043520041A26
	8 m	ED/DD	BSB 35-50 Rundsteckverb. 3-pol.	High Flex Leder	7S9SH083520041A26
ABITIG® 24W Little	4 m	ED/DD	BSB 35-50 Rundsteckverb. 3-pol.	High Flex Leder	7L9SH043520041A26
	8 m	ED/DD	BSB 35-50 Rundsteckverb. 3-pol.	High Flex Leder	7L9SH083520041A26
<hr/>					
ABITIG® 450W	4 m	ED/DD	BSB 35-50 Rundsteckverb. 3-pol.	Standard	7T5SK043520141A26
	8 m	ED/DD	BSB 35-50 Rundsteckverb. 3-pol.	Standard	7T5SK083520141A26
	4 m	ED/DD	BSB 35-50 Rundsteckverb. 3-pol.	High Flex Leder	7T5SH043520141A26
	8 m	ED/DD	BSB 35-50 Rundsteckverb. 3-pol.	High Flex Leder	7T5SH083520141A26
<hr/>					
ABITIG® 260W	4 m	ED/DD	BSB 35-50 Rundsteckverb. 3-pol.	Standard	7T7SK043520141A26
	8 m	ED/DD	BSB 35-50 Rundsteckverb. 3-pol.	Standard	7T7SK083520141A26
	4 m	ED/DD	BSB 35-50 Rundsteckverb. 3-pol.	High Flex Leder	7T7SH043520141A26
	8 m	ED/DD	BSB 35-50 Rundsteckverb. 3-pol.	High Flex Leder	7T7SH083520141A26
ABITIG® 260W Little	4 m	ED/DD	BSB 35-50 Rundsteckverb. 3-pol.	High Flex Leder	7L7SH043520141A26
	8 m	ED/DD	BSB 35-50 Rundsteckverb. 3-pol.	High Flex Leder	7L7SH083520141A26
<hr/>					
ABITIG® 450W SC	4 m	ED/DD	BSB 35-50 Rundsteckverb. 3-pol.	Standard	
	8 m	ED/DD	BSB 35-50 Rundsteckverb. 3-pol.	Standard	
	4 m	ED/DD	BSB 35-50 Rundsteckverb. 3-pol.	High Flex Leder	7T8SH043520141A26
	8 m	ED/DD	BSB 35-50 Rundsteckverb. 3-pol.	High Flex Leder	7T8SH083520141A26

ABITIG® GRIP / ABITIG® GRIP Little-Brennerpreisliste

passend für WIG-Stromquellen des Fabrikates „dalex“

Für dieses Gerätefabrikat ist in der Bestellnummer und somit auch im Lieferumfang das Ansteuermodul BIS-10 enthalten. Das Ansteuermodul BIS-10 enthält im Gegensatz zu BIS-02 die verstärkte Schalterausführung (2x) wegen der geräteabhängigen höheren Schaltströme.

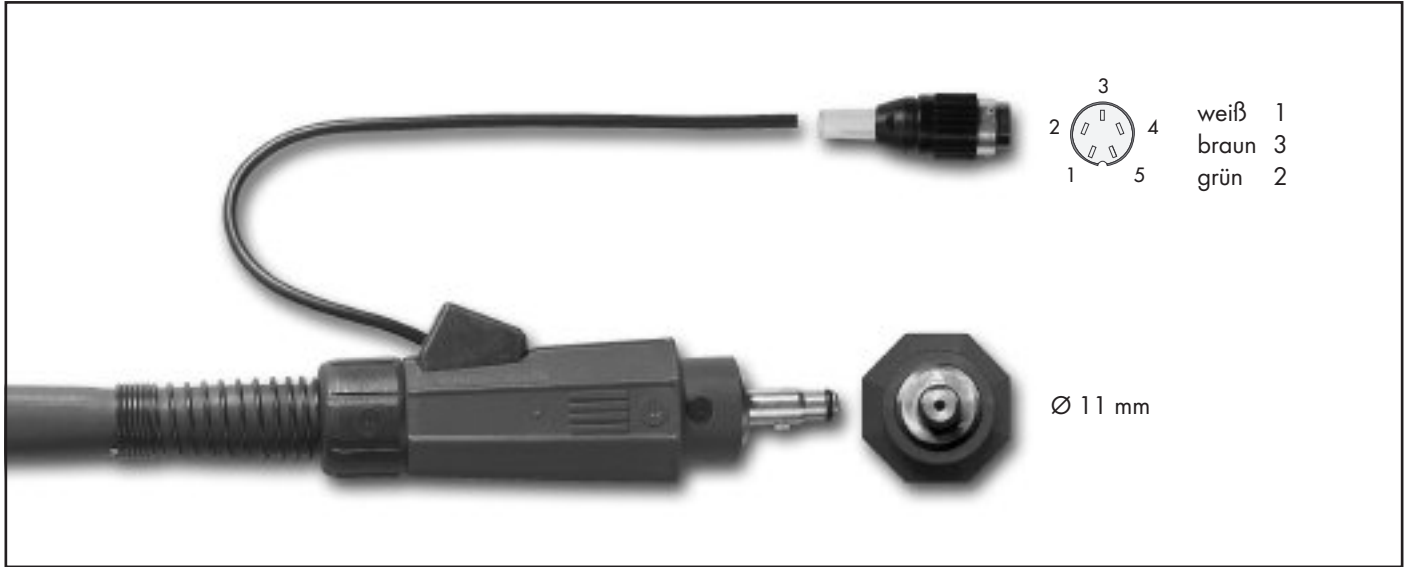

Brennertyp	Länge	Schalterfunktion	maschinenseitiger Anschluss	Schlauchpaketausführung	Bestellnummer	Preis (€)
ABITIG® 9	4 m	DD	dalex - BSB / CG Tuchel 5-pol.	Standard	7S1SK043602001B00	123.64
	8 m	DD	dalex - BSB / CG Tuchel 5-pol.	Standard	7S1SK083602001B00	147.78
	4 m	DD	dalex - BSB / CG Tuchel 5-pol.	High Flex Leder	7S1SH043602001B00	159.86
	8 m	DD	dalex - BSB / CG Tuchel 5-pol.	High Flex Leder	7S1SH083602001B00	193.45

ABITIG® 9F	4 m	DD	dalex - BSB / CG Tuchel 5-pol.	Standard	7S1FK043602001B00	129.43
	8 m	DD	dalex - BSB / CG Tuchel 5-pol.	Standard	7S1FK083602001B00	153.57
	4 m	DD	dalex - BSB / CG Tuchel 5-pol.	High Flex Leder	7S1FH043602001B00	165.65
	8 m	DD	dalex - BSB / CG Tuchel 5-pol.	High Flex Leder	7S1FH083602001B00	199.24

ABITIG® 17	4 m	DD	dalex - BSB / CG Tuchel 5-pol.	Standard	7S2SK043602001B00	126.89
	8 m	DD	dalex - BSB / CG Tuchel 5-pol.	Standard	7S2SK083602001B00	151.03
	4 m	DD	dalex - BSB / CG Tuchel 5-pol.	High Flex Leder	7S2SH043602001B00	168.34
	8 m	DD	dalex - BSB / CG Tuchel 5-pol.	High Flex Leder	7S2SH083602001B00	208.81

ABITIG® 17F	4 m	DD	dalex - BSB / CG Tuchel 5-pol.	Standard	7S2FK043602001B00	130.32
	8 m	DD	dalex - BSB / CG Tuchel 5-pol.	Standard	7S2FK083602001B00	154.46
	4 m	DD	dalex - BSB / CG Tuchel 5-pol.	High Flex Leder	7S2FH043602001B00	171.77
	8 m	DD	dalex - BSB / CG Tuchel 5-pol.	High Flex Leder	7S2FH083602001B00	212.24

Technische Änderungen vorbehalten • Verkaufspreise = unverbindliche Preisempfehlung - Angebot freibleibend • © Copyright

ABITIG® GRIP / ABITIG® GRIP Little-Brennerpreisliste

passend für WIG-Stromquellen des Fabrikates „dalex“

Brennertyp	Länge	Schalterfunktion	maschinenseitiger Anschluss	Schlauchpaketausführung	Bestellnummer	Preis (€)
ABITIG® 26	4 m	DD	dalex - BSB / CG Tuchel 5-pol.	Standard	7S3SK043602001B00	133.90
	8 m	DD	dalex - BSB / CG Tuchel 5-pol.	Standard	7S3SK083602001B00	164.48
	4 m	DD	dalex - BSB / CG Tuchel 5-pol.	High Flex Leder	7S3SH043602001B00	172.55
	8 m	DD	dalex - BSB / CG Tuchel 5-pol.	High Flex Leder	7S3SH083602001B00	217.74
ABITIG® 26F	4 m	DD	dalex - BSB / CG Tuchel 5-pol.	Standard	7S3FK043602001B00	140.30
	8 m	DD	dalex - BSB / CG Tuchel 5-pol.	Standard	7S3FK083602001B00	170.88
	4 m	DD	dalex - BSB / CG Tuchel 5-pol.	High Flex Leder	7S3FH043602001B00	178.95
	8 m	DD	dalex - BSB / CG Tuchel 5-pol.	High Flex Leder	7S3FH083602001B00	224.14
ABITIG® 24G	4 m	DD	dalex - BSB / CG Tuchel 5-pol.	Standard	7S8SK043602001B00	136.08
	8 m	DD	dalex - BSB / CG Tuchel 5-pol.	Standard	7S8SK083602001B00	160.22
	4 m	DD	dalex - BSB / CG Tuchel 5-pol.	High Flex Leder	7S8SH043602001B00	177.53
	8 m	DD	dalex - BSB / CG Tuchel 5-pol.	High Flex Leder	7S8SH083602001B00	218.00
ABITIG® 200	4 m	DD	dalex - BSB / CG Tuchel 5-pol.	Standard	7T4SK043602001B00	174.45
	8 m	DD	dalex - BSB / CG Tuchel 5-pol.	Standard	7T4SK083602001B00	213.45
	4 m	DD	dalex - BSB / CG Tuchel 5-pol.	High Flex Leder	7T4SH043602001B00	224.42
	8 m	DD	dalex - BSB / CG Tuchel 5-pol.	High Flex Leder	7T4SH083602001B00	282.53
ABITIG® 200F	4 m	DD	dalex - BSB / CG Tuchel 5-pol.	Standard	7T4FK043602001B00	183.61
	8 m	DD	dalex - BSB / CG Tuchel 5-pol.	Standard	7T4FK083602001B00	222.61
	4 m	DD	dalex - BSB / CG Tuchel 5-pol.	High Flex Leder	7T4FH043602001B00	233.58
	8 m	DD	dalex - BSB / CG Tuchel 5-pol.	High Flex Leder	7T4FH083602001B00	291.69
ABITIG® 150	4 m	DD	dalex - BSB / CG Tuchel 5-pol.	Standard	7T6SK043602001B00	166.47
	8 m	DD	dalex - BSB / CG Tuchel 5-pol.	Standard	7T6SK083602001B00	196.35
	4 m	DD	dalex - BSB / CG Tuchel 5-pol.	High Flex Leder	7T6SH043602001B00	218.58
	8 m	DD	dalex - BSB / CG Tuchel 5-pol.	High Flex Leder	7T6SH083602001B00	269.17
ABITIG® 150F	4 m	DD	dalex - BSB / CG Tuchel 5-pol.	Standard	7T6FK043602001B00	166.66
	8 m	DD	dalex - BSB / CG Tuchel 5-pol.	Standard	7T6FK083602001B00	196.54
	4 m	DD	dalex - BSB / CG Tuchel 5-pol.	High Flex Leder	7T6FH043602001B00	218.77
	8 m	DD	dalex - BSB / CG Tuchel 5-pol.	High Flex Leder	7T6FH083602001B00	269.36

ABITIG® GRIP / ABITIG® GRIP Little-Brennerpreisliste

passend für WIG-Stromquellen des Fabrikates „dalex“



Brennertyp	Länge	Schalterfunktion	maschinenseitiger Anschluss	Schlauchpaketausführung	Bestellnummer	Preis (€)
ABITIG® 9	4 m	DDP	dalex - BSB / CG Tuchel 5-pol. + Tuchel 7-pol.	Standard	7S1SK046542033A00	177.60
	8 m	DDP	dalex - BSB / CG Tuchel 5-pol. + Tuchel 7-pol.	Standard	7S1SK086542033A00	202.59
	4 m	DDP	dalex - BSB / CG Tuchel 5-pol. + Tuchel 7-pol.	High Flex Leder	7S1SH046542033A00	213.81
	8 m	DDP	dalex - BSB / CG Tuchel 5-pol. + Tuchel 7-pol.	High Flex Leder	7S1SH086542033A00	248.23

ABITIG® 9F	4 m	DDP	dalex - BSB / CG Tuchel 5-pol. + Tuchel 7-pol.	Standard	7S1FK046542033A00	183.39
	8 m	DDP	dalex - BSB / CG Tuchel 5-pol. + Tuchel 7-pol.	Standard	7S1FK086542033A00	208.38
	4 m	DDP	dalex - BSB / CG Tuchel 5-pol. + Tuchel 7-pol.	High Flex Leder	7S1FH046542033A00	219.60
	8 m	DDP	dalex - BSB / CG Tuchel 5-pol. + Tuchel 7-pol.	High Flex Leder	7S1FH086542033A00	254.02

ABITIG® 17	4 m	DDP	dalex - BSB / CG Tuchel 5-pol. + Tuchel 7-pol.	Standard	7S2SK046542033A00	180.85
	8 m	DDP	dalex - BSB / CG Tuchel 5-pol. + Tuchel 7-pol.	Standard	7S2SK086542033A00	205.84
	4 m	DDP	dalex - BSB / CG Tuchel 5-pol. + Tuchel 7-pol.	High Flex Leder	7S2SH046542033A00	222.25
	8 m	DDP	dalex - BSB / CG Tuchel 5-pol. + Tuchel 7-pol.	High Flex Leder	7S2SH086542033A00	263.61

ABITIG® 17F	4 m	DDP	dalex - BSB / CG Tuchel 5-pol. + Tuchel 7-pol.	Standard	7S2FK046542033A00	184.28
	8 m	DDP	dalex - BSB / CG Tuchel 5-pol. + Tuchel 7-pol.	Standard	7S2FK086542033A00	209.27
	4 m	DDP	dalex - BSB / CG Tuchel 5-pol. + Tuchel 7-pol.	High Flex Leder	7S2FH046542033A00	225.68
	8 m	DDP	dalex - BSB / CG Tuchel 5-pol. + Tuchel 7-pol.	High Flex Leder	7S2FH086542033A00	267.04

Technische Änderungen vorbehalten • Verkaufspreise = unverbindliche Preisempfehlung - Angebot freibleibend • © Copyright

ABITIG® GRIP / ABITIG® GRIP Little-Brennerpreisliste

passend für WIG-Stromquellen des Fabrikates „dalex“

Brennertyp	Länge	Schalterfunktion	maschinenseitiger Anschluss	Schlauchpaketausführung	Bestellnummer	Preis (€)
ABITIG® 26	4 m	DDP	dalex - BSB / CG Tuchel 5-pol. + Tuchel 7-pol.	Standard	7S3SK046542033A00	187.82
	8 m	DDP	dalex - BSB / CG Tuchel 5-pol. + Tuchel 7-pol.	Standard	7S3SK086542033A00	219.25
	4 m	DDP	dalex - BSB / CG Tuchel 5-pol. + Tuchel 7-pol.	High Flex Leder	7S3SH046542033A00	226.46
	8 m	DDP	dalex - BSB / CG Tuchel 5-pol. + Tuchel 7-pol.	High Flex Leder	7S3SH086542033A00	272.51

ABITIG® 26F	4 m	DDP	dalex - BSB / CG Tuchel 5-pol. + Tuchel 7-pol.	Standard	7S3FK046542033A00	194.22
	8 m	DDP	dalex - BSB / CG Tuchel 5-pol. + Tuchel 7-pol.	Standard	7S3FK086542033A00	225.65
	4 m	DDP	dalex - BSB / CG Tuchel 5-pol. + Tuchel 7-pol.	High Flex Leder	7S3FH046542033A00	232.86
	8 m	DDP	dalex - BSB / CG Tuchel 5-pol. + Tuchel 7-pol.	High Flex Leder	7S3FH086542033A00	278.91

ABITIG® 24G	4 m	DDP	dalex - BSB / CG Tuchel 5-pol. + Tuchel 7-pol.	Standard	7S8SK046542033A00	190.04
	8 m	DDP	dalex - BSB / CG Tuchel 5-pol. + Tuchel 7-pol.	Standard	7S8SK086542033A00	215.03
	4 m	DDP	dalex - BSB / CG Tuchel 5-pol. + Tuchel 7-pol.	High Flex Leder	7S8SH046542033A00	231.44
	8 m	DDP	dalex - BSB / CG Tuchel 5-pol. + Tuchel 7-pol.	High Flex Leder	7S8SH086542033A00	272.80

ABITIG® 200	4 m	DDP	dalex - BSB / CG Tuchel 5-pol. + Tuchel 7-pol.	Standard	7T4SK046542033A00	242.99
	8 m	DDP	dalex - BSB / CG Tuchel 5-pol. + Tuchel 7-pol.	Standard	7T4SK086542033A00	283.86
	4 m	DDP	dalex - BSB / CG Tuchel 5-pol. + Tuchel 7-pol.	High Flex Leder	7T4SH046542033A00	293.74
	8 m	DDP	dalex - BSB / CG Tuchel 5-pol. + Tuchel 7-pol.	High Flex Leder	7T4SH086542033A00	352.94

ABITIG® 200F	4 m	DDP	dalex - BSB / CG Tuchel 5-pol. + Tuchel 7-pol.	Standard	7T4FK046542033A00	252.15
	8 m	DDP	dalex - BSB / CG Tuchel 5-pol. + Tuchel 7-pol.	Standard	7T4FK086542033A00	293.02
	4 m	DDP	dalex - BSB / CG Tuchel 5-pol. + Tuchel 7-pol.	High Flex Leder	7T4FH046542033A00	302.90
	8 m	DDP	dalex - BSB / CG Tuchel 5-pol. + Tuchel 7-pol.	High Flex Leder	7T4FH086542033A00	362.10

ABITIG® 150	4 m	DDP	dalex - BSB / CG Tuchel 5-pol. + Tuchel 7-pol.	Standard	7T6SK046542033A00	233.87
	8 m	DDP	dalex - BSB / CG Tuchel 5-pol. + Tuchel 7-pol.	Standard	7T6SK086542033A00	264.82
	4 m	DDP	dalex - BSB / CG Tuchel 5-pol. + Tuchel 7-pol.	High Flex Leder	7T6SH046542033A00	285.98
	8 m	DDP	dalex - BSB / CG Tuchel 5-pol. + Tuchel 7-pol.	High Flex Leder	7T6SH086542033A00	337.63

ABITIG® 150F	4 m	DDP	dalex - BSB / CG Tuchel 5-pol. + Tuchel 7-pol.	Standard	7T6FK046542033A00	234.06
	8 m	DDP	dalex - BSB / CG Tuchel 5-pol. + Tuchel 7-pol.	Standard	7T6FK086542033A00	265.01
	4 m	DDP	dalex - BSB / CG Tuchel 5-pol. + Tuchel 7-pol.	High Flex Leder	7T6FH046542033A00	286.17
	8 m	DDP	dalex - BSB / CG Tuchel 5-pol. + Tuchel 7-pol.	High Flex Leder	7T6FH086542033A00	337.82

ABITIG® GRIP / ABITIG® GRIP Little-Brennerpreisliste

passend für WIG-Stromquellen des Fabrikates „d+l“



Brennertyp	Länge	Schalterfunktion	maschinenseitiger Anschluss	Schlauchpaketausführung	Bestellnummer
ABITIG® 18	4 m	ED	BSB 35-50 Tuchel 5-pol.	Standard	7S4SK043510001A11
	8 m	ED	BSB 35-50 Tuchel 5-pol.	Standard	7S4SK083510001A11
	4 m	ED	BSB 35-50 Tuchel 5-pol.	High Flex Leder	7S4SH043510001A11
	8 m	ED	BSB 35-50 Tuchel 5-pol.	High Flex Leder	7S4SH083510001A11
ABITIG® 18F	4 m	ED	BSB 35-50 Tuchel 5-pol.	Standard	7S4FK043510001A11
	8 m	ED	BSB 35-50 Tuchel 5-pol.	Standard	7S4FK083510001A11
	4 m	ED	BSB 35-50 Tuchel 5-pol.	High Flex Leder	7S4FH043510001A11
	8 m	ED	BSB 35-50 Tuchel 5-pol.	High Flex Leder	7S4FH083510001A11
ABITIG® 20	4 m	ED	BSB 35-50 Tuchel 5-pol.	Standard	7S5SK043510001A11
	8 m	ED	BSB 35-50 Tuchel 5-pol.	Standard	7S5SK083510001A11
	4 m	ED	BSB 35-50 Tuchel 5-pol.	High Flex Leder	7S5SH043510001A11
	8 m	ED	BSB 35-50 Tuchel 5-pol.	High Flex Leder	7S5SH083510001A11
ABITIG® 20 Little	4 m	ED	BSB 35-50 Tuchel 5-pol.	High Flex Leder	7L5SH043510001A11
	8 m	ED	BSB 35-50 Tuchel 5-pol.	High Flex Leder	7L5SH083510001A11
ABITIG® 20F	4 m	ED	BSB 35-50 Tuchel 5-pol.	Standard	7S5FK043510001A11
	8 m	ED	BSB 35-50 Tuchel 5-pol.	Standard	7S5FK083510001A11
	4 m	ED	BSB 35-50 Tuchel 5-pol.	High Flex Leder	7S5FH043510001A11
	8 m	ED	BSB 35-50 Tuchel 5-pol.	High Flex Leder	7S5FH083510001A11
ABITIG® 20F Little	4 m	ED	BSB 35-50 Tuchel 5-pol.	High Flex Leder	7L5FH043510001A11
	8 m	ED	BSB 35-50 Tuchel 5-pol.	High Flex Leder	7L5FH083510001A11

Technische Änderungen vorbehalten • Verkaufspreise = unverbindliche Preisempfehlung - Angebot freibleibend • © Copyright

ABITIG® GRIP / ABITIG® GRIP Little-Brennerpreisliste

passend für WIG-Stromquellen des Fabrikates „d+l“

Brennertyp	Länge	Schalterfunktion	maschinenseitiger Anschluss	Schlauchpaketausführung	Bestellnummer
ABITIG® 12-1	4 m	ED	BSB 35-50 Tuchel 5-pol.	Standard	7S6SK043510001A11
	8 m	ED	BSB 35-50 Tuchel 5-pol.	Standard	7S6SK083510001A11
	4 m	ED	BSB 35-50 Tuchel 5-pol.	High Flex Leder	7S6SH043510001A11
	8 m	ED	BSB 35-50 Tuchel 5-pol.	High Flex Leder	7S6SH083510001A11
ABITIG® 18SC	4 m	ED	BSB 35-50 Tuchel 5-pol.	Standard	7S7SK043510001A11
	8 m	ED	BSB 35-50 Tuchel 5-pol.	Standard	7S7SK083510001A11
	4 m	ED	BSB 35-50 Tuchel 5-pol.	High Flex Leder	7S7SH043510001A11
	8 m	ED	BSB 35-50 Tuchel 5-pol.	High Flex Leder	7S7SH083510001A11
ABITIG® 24W	4 m	ED	BSB 35-50 Tuchel 5-pol.	Standard	7S9SK043510001A11
	8 m	ED	BSB 35-50 Tuchel 5-pol.	Standard	7S9SK083510001A11
	4 m	ED	BSB 35-50 Tuchel 5-pol.	High Flex Leder	7S9SH043510001A11
	8 m	ED	BSB 35-50 Tuchel 5-pol.	High Flex Leder	7S9SH083510001A11
ABITIG® 24W Little	4 m	ED	BSB 35-50 Tuchel 5-pol.	High Flex Leder	7L9SH043510001A11
	8 m	ED	BSB 35-50 Tuchel 5-pol.	High Flex Leder	7L9SH083510001A11
ABITIG® 450W	4 m	ED	BSB 35-50 Tuchel 5-pol.	Standard	7T5SK043510101A11
	8 m	ED	BSB 35-50 Tuchel 5-pol.	Standard	7T5SK083510101A11
	4 m	ED	BSB 35-50 Tuchel 5-pol.	High Flex Leder	7T5SH043510101A11
	8 m	ED	BSB 35-50 Tuchel 5-pol.	High Flex Leder	7T5SH083510101A11
ABITIG® 260W	4 m	ED	BSB 35-50 Tuchel 5-pol.	Standard	7T7SK043510101A11
	8 m	ED	BSB 35-50 Tuchel 5-pol.	Standard	7T7SK083510101A11
	4 m	ED	BSB 35-50 Tuchel 5-pol.	High Flex Leder	7T7SH043510101A11
	8 m	ED	BSB 35-50 Tuchel 5-pol.	High Flex Leder	7T7SH083510101A11
ABITIG® 260W Little	4 m	ED	BSB 35-50 Tuchel 5-pol.	High Flex Leder	7L7SH043510101A11
	8 m	ED	BSB 35-50 Tuchel 5-pol.	High Flex Leder	7L7SH083510101A11
ABITIG® 450W SC	4 m	ED	BSB 35-50 Tuchel 5-pol.	Standard	
	8 m	ED	BSB 35-50 Tuchel 5-pol.	Standard	
	4 m	ED	BSB 35-50 Tuchel 5-pol.	High Flex Leder	7T8SH043510101A11
	8 m	ED	BSB 35-50 Tuchel 5-pol.	High Flex Leder	7T8SH083510101A11

ABITIG® GRIP / ABITIG® GRIP Little-Brennerpreisliste

passend für WIG-Stromquellen des Fabrikates „dalex“

Für dieses Gerätefabrikat ist in der Bestellnummer und somit auch im Lieferumfang das Ansteuermodul BIS-10 enthalten. Das Ansteuermodul BIS-10 enthält im Gegensatz zu BIS-02 die verstärkte Schalterausführung (2x) wegen der geräteabhängigen höheren Schaltströme.

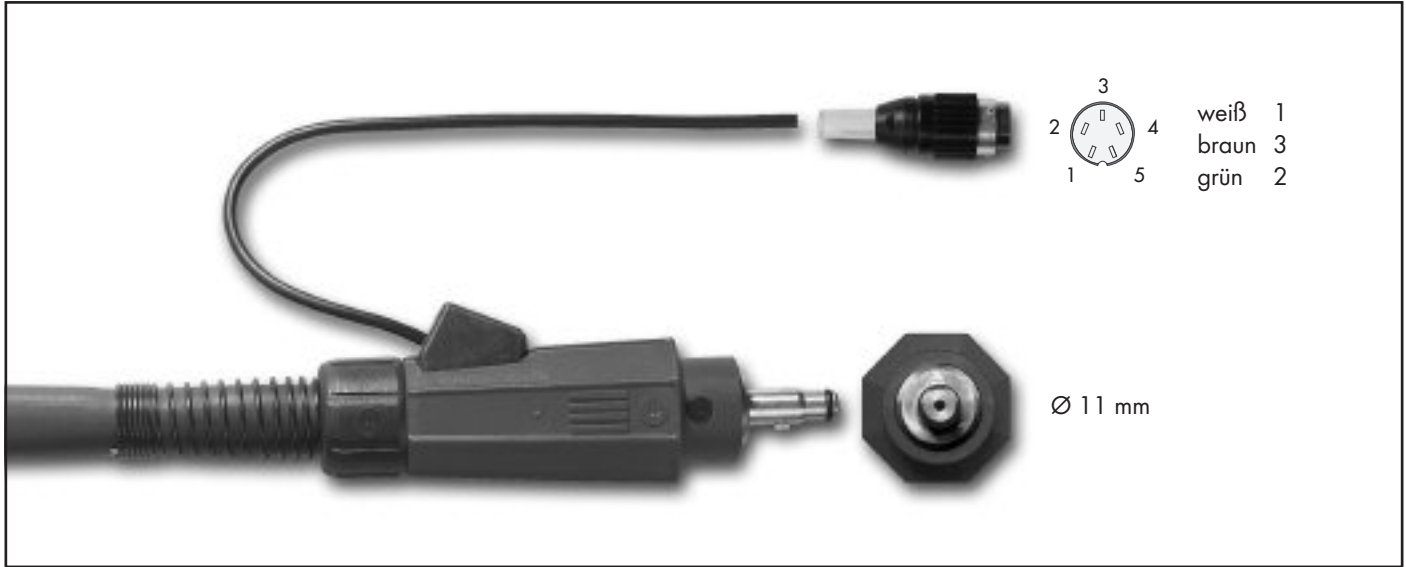

Brennertyp	Länge	Schalterfunktion	maschinenseitiger Anschluss	Schlauchpaketausführung	Bestellnummer
ABITIG® 9	4 m	DD	dalex - BSB / CG Tuchel 5-pol.	Standard	7S1SK043602001B00
	8 m	DD	dalex - BSB / CG Tuchel 5-pol.	Standard	7S1SK083602001B00
	4 m	DD	dalex - BSB / CG Tuchel 5-pol.	High Flex Leder	7S1SH043602001B00
	8 m	DD	dalex - BSB / CG Tuchel 5-pol.	High Flex Leder	7S1SH083602001B00
ABITIG® 9F	4 m	DD	dalex - BSB / CG Tuchel 5-pol.	Standard	7S1FK043602001B00
	8 m	DD	dalex - BSB / CG Tuchel 5-pol.	Standard	7S1FK083602001B00
	4 m	DD	dalex - BSB / CG Tuchel 5-pol.	High Flex Leder	7S1FH043602001B00
	8 m	DD	dalex - BSB / CG Tuchel 5-pol.	High Flex Leder	7S1FH083602001B00
ABITIG® 17	4 m	DD	dalex - BSB / CG Tuchel 5-pol.	Standard	7S2SK043602001B00
	8 m	DD	dalex - BSB / CG Tuchel 5-pol.	Standard	7S2SK083602001B00
	4 m	DD	dalex - BSB / CG Tuchel 5-pol.	High Flex Leder	7S2SH043602001B00
	8 m	DD	dalex - BSB / CG Tuchel 5-pol.	High Flex Leder	7S2SH083602001B00
ABITIG® 17F	4 m	DD	dalex - BSB / CG Tuchel 5-pol.	Standard	7S2FK043602001B00
	8 m	DD	dalex - BSB / CG Tuchel 5-pol.	Standard	7S2FK083602001B00
	4 m	DD	dalex - BSB / CG Tuchel 5-pol.	High Flex Leder	7S2FH043602001B00
	8 m	DD	dalex - BSB / CG Tuchel 5-pol.	High Flex Leder	7S2FH083602001B00

Technische Änderungen vorbehalten • Verkaufspreise = unverbindliche Preisempfehlung - Angebot freibleibend • © Copyright

ABITIG® GRIP / ABITIG® GRIP Little-Brennerpreisliste

passend für WIG-Stromquellen des Fabrikates „dalex“

Brennertyp	Länge	Schalterfunktion	maschinenseitiger Anschluss	Schlauchpaketausführung	Bestellnummer
ABITIG® 26	4 m	DD	dalex - BSB / CG Tuchel 5-pol.	Standard	7S3SK043602001B00
	8 m	DD	dalex - BSB / CG Tuchel 5-pol.	Standard	7S3SK083602001B00
	4 m	DD	dalex - BSB / CG Tuchel 5-pol.	High Flex Leder	7S3SH043602001B00
	8 m	DD	dalex - BSB / CG Tuchel 5-pol.	High Flex Leder	7S3SH083602001B00
ABITIG® 26F	4 m	DD	dalex - BSB / CG Tuchel 5-pol.	Standard	7S3FK043602001B00
	8 m	DD	dalex - BSB / CG Tuchel 5-pol.	Standard	7S3FK083602001B00
	4 m	DD	dalex - BSB / CG Tuchel 5-pol.	High Flex Leder	7S3FH043602001B00
	8 m	DD	dalex - BSB / CG Tuchel 5-pol.	High Flex Leder	7S3FH083602001B00
ABITIG® 24G	4 m	DD	dalex - BSB / CG Tuchel 5-pol.	Standard	7S8SK043602001B00
	8 m	DD	dalex - BSB / CG Tuchel 5-pol.	Standard	7S8SK083602001B00
	4 m	DD	dalex - BSB / CG Tuchel 5-pol.	High Flex Leder	7S8SH043602001B00
	8 m	DD	dalex - BSB / CG Tuchel 5-pol.	High Flex Leder	7S8SH083602001B00
ABITIG® 200	4 m	DD	dalex - BSB / CG Tuchel 5-pol.	Standard	7T4SK043602001B00
	8 m	DD	dalex - BSB / CG Tuchel 5-pol.	Standard	7T4SK083602001B00
	4 m	DD	dalex - BSB / CG Tuchel 5-pol.	High Flex Leder	7T4SH043602001B00
	8 m	DD	dalex - BSB / CG Tuchel 5-pol.	High Flex Leder	7T4SH083602001B00
ABITIG® 200F	4 m	DD	dalex - BSB / CG Tuchel 5-pol.	Standard	7T4FK043602001B00
	8 m	DD	dalex - BSB / CG Tuchel 5-pol.	Standard	7T4FK083602001B00
	4 m	DD	dalex - BSB / CG Tuchel 5-pol.	High Flex Leder	7T4FH043602001B00
	8 m	DD	dalex - BSB / CG Tuchel 5-pol.	High Flex Leder	7T4FH083602001B00
ABITIG® 150	4 m	DD	dalex - BSB / CG Tuchel 5-pol.	Standard	7T6SK043602001B00
	8 m	DD	dalex - BSB / CG Tuchel 5-pol.	Standard	7T6SK083602001B00
	4 m	DD	dalex - BSB / CG Tuchel 5-pol.	High Flex Leder	7T6SH043602001B00
	8 m	DD	dalex - BSB / CG Tuchel 5-pol.	High Flex Leder	7T6SH083602001B00
ABITIG® 150F	4 m	DD	dalex - BSB / CG Tuchel 5-pol.	Standard	7T6FK043602001B00
	8 m	DD	dalex - BSB / CG Tuchel 5-pol.	Standard	7T6FK083602001B00
	4 m	DD	dalex - BSB / CG Tuchel 5-pol.	High Flex Leder	7T6FH043602001B00
	8 m	DD	dalex - BSB / CG Tuchel 5-pol.	High Flex Leder	7T6FH083602001B00

ABITIG® GRIP / ABITIG® GRIP Little-Brennerpreisliste

passend für WIG-Stromquellen des Fabrikates „dalex“



Brennertyp	Länge	Schalterfunktion	maschinenseitiger Anschluss	Schlauchpaketausführung	Bestellnummer
ABITIG® 9	4 m	DDP	dalex - BSB / CG Tuchel 5-pol. + Tuchel 7-pol.	Standard	7S1SK046542033A00
	8 m	DDP	dalex - BSB / CG Tuchel 5-pol. + Tuchel 7-pol.	Standard	7S1SK086542033A00
	4 m	DDP	dalex - BSB / CG Tuchel 5-pol. + Tuchel 7-pol.	High Flex Leder	7S1SH046542033A00
	8 m	DDP	dalex - BSB / CG Tuchel 5-pol. + Tuchel 7-pol.	High Flex Leder	7S1SH086542033A00
ABITIG® 9F	4 m	DDP	dalex - BSB / CG Tuchel 5-pol. + Tuchel 7-pol.	Standard	7S1FK046542033A00
	8 m	DDP	dalex - BSB / CG Tuchel 5-pol. + Tuchel 7-pol.	Standard	7S1FK086542033A00
	4 m	DDP	dalex - BSB / CG Tuchel 5-pol. + Tuchel 7-pol.	High Flex Leder	7S1FH046542033A00
	8 m	DDP	dalex - BSB / CG Tuchel 5-pol. + Tuchel 7-pol.	High Flex Leder	7S1FH086542033A00
ABITIG® 17	4 m	DDP	dalex - BSB / CG Tuchel 5-pol. + Tuchel 7-pol.	Standard	7S2SK046542033A00
	8 m	DDP	dalex - BSB / CG Tuchel 5-pol. + Tuchel 7-pol.	Standard	7S2SK086542033A00
	4 m	DDP	dalex - BSB / CG Tuchel 5-pol. + Tuchel 7-pol.	High Flex Leder	7S2SH046542033A00
	8 m	DDP	dalex - BSB / CG Tuchel 5-pol. + Tuchel 7-pol.	High Flex Leder	7S2SH086542033A00
ABITIG® 17F	4 m	DDP	dalex - BSB / CG Tuchel 5-pol. + Tuchel 7-pol.	Standard	7S2FK046542033A00
	8 m	DDP	dalex - BSB / CG Tuchel 5-pol. + Tuchel 7-pol.	Standard	7S2FK086542033A00
	4 m	DDP	dalex - BSB / CG Tuchel 5-pol. + Tuchel 7-pol.	High Flex Leder	7S2FH046542033A00
	8 m	DDP	dalex - BSB / CG Tuchel 5-pol. + Tuchel 7-pol.	High Flex Leder	7S2FH086542033A00

Technische Änderungen vorbehalten • Verkaufspreise = unverbindliche Preisempfehlung - Angebot freibleibend • © Copyright

ABITIG® GRIP / ABITIG® GRIP Little-Brennerpreisliste

passend für WIG-Stromquellen des Fabrikates „dalex“

Brennertyp	Länge	Schalterfunktion	maschinenseitiger Anschluss	Schlauchpaketausführung	Bestellnummer
ABITIG® 26	4 m	DDP	dalex - BSB / CG Tuchel 5-pol. + Tuchel 7-pol.	Standard	7S3SK046542033A00
	8 m	DDP	dalex - BSB / CG Tuchel 5-pol. + Tuchel 7-pol.	Standard	7S3SK086542033A00
	4 m	DDP	dalex - BSB / CG Tuchel 5-pol. + Tuchel 7-pol.	High Flex Leder	7S3SH046542033A00
	8 m	DDP	dalex - BSB / CG Tuchel 5-pol. + Tuchel 7-pol.	High Flex Leder	7S3SH086542033A00
ABITIG® 26F	4 m	DDP	dalex - BSB / CG Tuchel 5-pol. + Tuchel 7-pol.	Standard	7S3FK046542033A00
	8 m	DDP	dalex - BSB / CG Tuchel 5-pol. + Tuchel 7-pol.	Standard	7S3FK086542033A00
	4 m	DDP	dalex - BSB / CG Tuchel 5-pol. + Tuchel 7-pol.	High Flex Leder	7S3FH046542033A00
	8 m	DDP	dalex - BSB / CG Tuchel 5-pol. + Tuchel 7-pol.	High Flex Leder	7S3FH086542033A00
ABITIG® 24G	4 m	DDP	dalex - BSB / CG Tuchel 5-pol. + Tuchel 7-pol.	Standard	7S8SK046542033A00
	8 m	DDP	dalex - BSB / CG Tuchel 5-pol. + Tuchel 7-pol.	Standard	7S8SK086542033A00
	4 m	DDP	dalex - BSB / CG Tuchel 5-pol. + Tuchel 7-pol.	High Flex Leder	7S8SH046542033A00
	8 m	DDP	dalex - BSB / CG Tuchel 5-pol. + Tuchel 7-pol.	High Flex Leder	7S8SH086542033A00
ABITIG® 200	4 m	DDP	dalex - BSB / CG Tuchel 5-pol. + Tuchel 7-pol.	Standard	7T4SK046542033A00
	8 m	DDP	dalex - BSB / CG Tuchel 5-pol. + Tuchel 7-pol.	Standard	7T4SK086542033A00
	4 m	DDP	dalex - BSB / CG Tuchel 5-pol. + Tuchel 7-pol.	High Flex Leder	7T4SH046542033A00
	8 m	DDP	dalex - BSB / CG Tuchel 5-pol. + Tuchel 7-pol.	High Flex Leder	7T4SH086542033A00
ABITIG® 200F	4 m	DDP	dalex - BSB / CG Tuchel 5-pol. + Tuchel 7-pol.	Standard	7T4FK046542033A00
	8 m	DDP	dalex - BSB / CG Tuchel 5-pol. + Tuchel 7-pol.	Standard	7T4FK086542033A00
	4 m	DDP	dalex - BSB / CG Tuchel 5-pol. + Tuchel 7-pol.	High Flex Leder	7T4FH046542033A00
	8 m	DDP	dalex - BSB / CG Tuchel 5-pol. + Tuchel 7-pol.	High Flex Leder	7T4FH086542033A00
ABITIG® 150	4 m	DDP	dalex - BSB / CG Tuchel 5-pol. + Tuchel 7-pol.	Standard	7T6SK046542033A00
	8 m	DDP	dalex - BSB / CG Tuchel 5-pol. + Tuchel 7-pol.	Standard	7T6SK086542033A00
	4 m	DDP	dalex - BSB / CG Tuchel 5-pol. + Tuchel 7-pol.	High Flex Leder	7T6SH046542033A00
	8 m	DDP	dalex - BSB / CG Tuchel 5-pol. + Tuchel 7-pol.	High Flex Leder	7T6SH086542033A00
ABITIG® 150F	4 m	DDP	dalex - BSB / CG Tuchel 5-pol. + Tuchel 7-pol.	Standard	7T6FK046542033A00
	8 m	DDP	dalex - BSB / CG Tuchel 5-pol. + Tuchel 7-pol.	Standard	7T6FK086542033A00
	4 m	DDP	dalex - BSB / CG Tuchel 5-pol. + Tuchel 7-pol.	High Flex Leder	7T6FH046542033A00
	8 m	DDP	dalex - BSB / CG Tuchel 5-pol. + Tuchel 7-pol.	High Flex Leder	7T6FH086542033A00

ABITIG® GRIP / ABITIG® GRIP Little-Brennerpreisliste

passend für WIG-Stromquellen des Fabrikates „dalex“

Für dieses Gerätefabrikat ist in der Bestellnummer und somit auch im Lieferumfang das Ansteuermodul BIS-10 enthalten. Das Ansteuermodul BIS-10 enthält im Gegensatz zu BIS-02 die verstärkte Schalterausführung (2x) wegen der geräteabhängigen höheren Schaltströme.



Brennertyp	Länge	Schalterfunktion	maschinenseitiger Anschluss	Schlauchpaketausführung	Bestellnummer
ABITIG® 9	4 m	ED	EA Tuchel 3-pol.	Standard	7S1SK043600920A00
	8 m	ED	EA Tuchel 3-pol.	Standard	7S1SK083600920A00
	4 m	ED	EA Tuchel 3-pol.	High Flex Leder	7S1SH043600920A00
	8 m	ED	EA Tuchel 3-pol.	High Flex Leder	7S1SH083600920A00
ABITIG® 9F	4 m	ED	EA Tuchel 3-pol.	Standard	7S1FK043600920A00
	8 m	ED	EA Tuchel 3-pol.	Standard	7S1FK083600920A00
	4 m	ED	EA Tuchel 3-pol.	High Flex Leder	7S1FH043600920A00
	8 m	ED	EA Tuchel 3-pol.	High Flex Leder	7S1FH083600920A00
ABITIG® 17	4 m	ED	EA Tuchel 3-pol.	Standard	7S2SK043600920A00
	8 m	ED	EA Tuchel 3-pol.	Standard	7S2SK083600920A00
	4 m	ED	EA Tuchel 3-pol.	High Flex Leder	7S2SH043600920A00
	8 m	ED	EA Tuchel 3-pol.	High Flex Leder	7S2SH083600920A00
ABITIG® 17F	4 m	ED	EA Tuchel 3-pol.	Standard	7S2FK043600920A00
	8 m	ED	EA Tuchel 3-pol.	Standard	7S2FK083600920A00
	4 m	ED	EA Tuchel 3-pol.	High Flex Leder	7S2FH043600920A00
	8 m	ED	EA Tuchel 3-pol.	High Flex Leder	7S2FH083600920A00

ABITIG® GRIP / ABITIG® GRIP Little-Brennerpreisliste

passend für WIG-Stromquellen des Fabrikates „dalex“

Brennertyp	Länge	Schalterfunktion	maschinenseitiger Anschluss	Schlauchpaketausführung	Bestellnummer
ABITIG® 26	4 m	ED	EA Tuchel 3-pol.	Standard	7S3SK043600920A00
	8 m	ED	EA Tuchel 3-pol.	Standard	7S3SK083600920A00
	4 m	ED	EA Tuchel 3-pol.	High Flex Leder	7S3SH043600920A00
	8 m	ED	EA Tuchel 3-pol.	High Flex Leder	7S3SH083600920A00
ABITIG® 26F	4 m	ED	EA Tuchel 3-pol.	Standard	7S3FK043600920A00
	8 m	ED	EA Tuchel 3-pol.	Standard	7S3FK083600920A00
	4 m	ED	EA Tuchel 3-pol.	High Flex Leder	7S3FH043600920A00
	8 m	ED	EA Tuchel 3-pol.	High Flex Leder	7S3FH083600920A00
ABITIG® 24G	4 m	ED	EA Tuchel 3-pol.	Standard	7S8SK043600920A00
	8 m	ED	EA Tuchel 3-pol.	Standard	7S8SK083600920A00
	4 m	ED	EA Tuchel 3-pol.	High Flex Leder	7S8SH043600920A00
	8 m	ED	EA Tuchel 3-pol.	High Flex Leder	7S8SH083600920A00
ABITIG® 200	4 m	ED	EA Tuchel 3-pol.	Standard	7T4SK043600920A00
	8 m	ED	EA Tuchel 3-pol.	Standard	7T4SK083600920A00
	4 m	ED	EA Tuchel 3-pol.	High Flex Leder	7T4SH043600920A00
	8 m	ED	EA Tuchel 3-pol.	High Flex Leder	7T4SH083600920A00
ABITIG® 200F	4 m	ED	EA Tuchel 3-pol.	Standard	7T4FK043600920A00
	8 m	ED	EA Tuchel 3-pol.	Standard	7T4FK083600920A00
	4 m	ED	EA Tuchel 3-pol.	High Flex Leder	7T4FH043600920A00
	8 m	ED	EA Tuchel 3-pol.	High Flex Leder	7T4FH083600920A00
ABITIG® 150	4 m	ED	EA Tuchel 3-pol.	Standard	7T6SK043600920A00
	8 m	ED	EA Tuchel 3-pol.	Standard	7T6SK083600920A00
	4 m	ED	EA Tuchel 3-pol.	High Flex Leder	7T6SH043600920A00
	8 m	ED	EA Tuchel 3-pol.	High Flex Leder	7T6SH083600920A00
ABITIG® 150F	4 m	ED	EA Tuchel 3-pol.	Standard	7T6FK043600920A00
	8 m	ED	EA Tuchel 3-pol.	Standard	7T6FK083600920A00
	4 m	ED	EA Tuchel 3-pol.	High Flex Leder	7T6FH043600920A00
	8 m	ED	EA Tuchel 3-pol.	High Flex Leder	7T6FH083600920A00

ABITIG® GRIP / ABITIG® GRIP Little-Brennerpreisliste

passend für WIG-Stromquellen des Fabrikates „dalex“

Für dieses Gerätefabrikat ist in der Bestellnummer und somit auch im Lieferumfang das Ansteuermodul BIS-10 enthalten. Das Ansteuermodul BIS-10 enthält im Gegensatz zu BIS-02 die verstärkte Schalterausführung (2x) wegen der geräteabhängigen höheren Schaltströme.

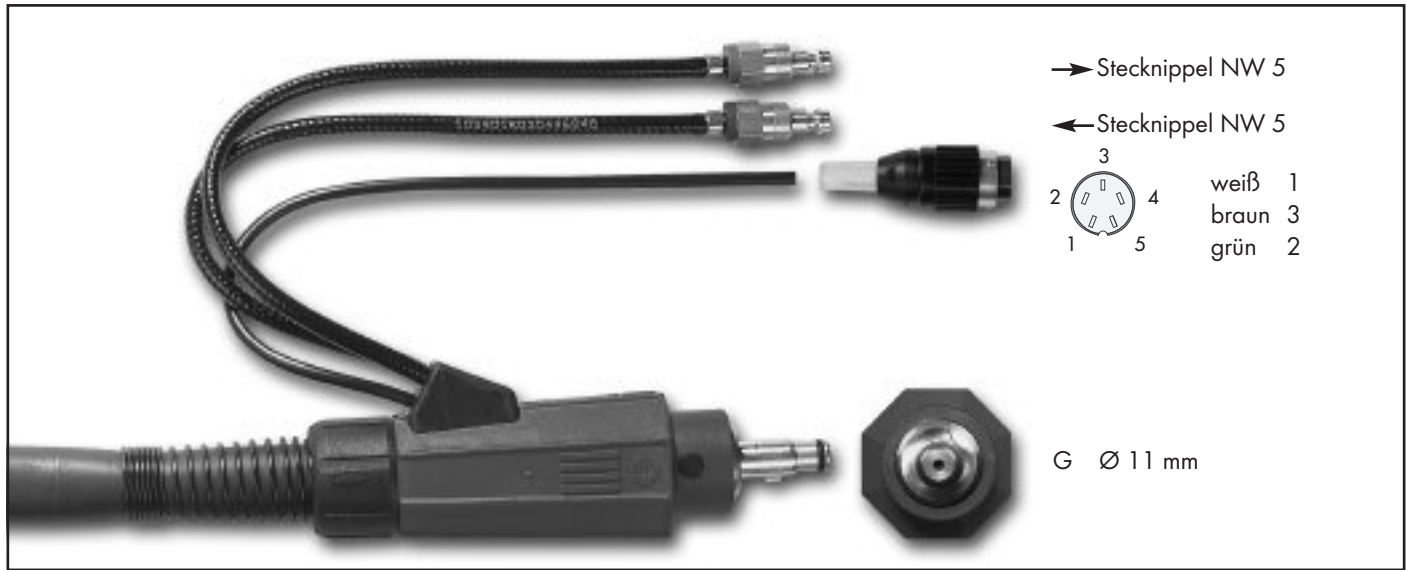

Brennertyp	Länge	Schalterfunktion	maschinenseitiger Anschluss	Schlauchpaketausführung	Bestellnummer
ABITIG® 18	4 m	DD	dalex - BSB / CG Tuchel 5-pol.	Standard	7S4SK043602001B18
	8 m	DD	dalex - BSB / CG Tuchel 5-pol.	Standard	7S4SK083602001B18
	4 m	DD	dalex - BSB / CG Tuchel 5-pol.	High Flex Leder	7S4SH043602001B18
	8 m	DD	dalex - BSB / CG Tuchel 5-pol.	High Flex Leder	7S4SH083602001B18
ABITIG® 18F	4 m	DD	dalex - BSB / CG Tuchel 5-pol.	Standard	7S4FK043602001B18
	8 m	DD	dalex - BSB / CG Tuchel 5-pol.	Standard	7S4FK083602001B18
	4 m	DD	dalex - BSB / CG Tuchel 5-pol.	High Flex Leder	7S4FH043602001B18
	8 m	DD	dalex - BSB / CG Tuchel 5-pol.	High Flex Leder	7S4FH083602001B18
ABITIG® 20	4 m	DD	dalex - BSB / CG Tuchel 5-pol.	Standard	7S5SK043602001B18
	8 m	DD	dalex - BSB / CG Tuchel 5-pol.	Standard	7S5SK083602001B18
	4 m	DD	dalex - BSB / CG Tuchel 5-pol.	High Flex Leder	7S5SH043602001B18
	8 m	DD	dalex - BSB / CG Tuchel 5-pol.	High Flex Leder	7S5SH083602001B18
ABITIG® 20F	4 m	DD	dalex - BSB / CG Tuchel 5-pol.	Standard	7S5FK043602001B18
	8 m	DD	dalex - BSB / CG Tuchel 5-pol.	Standard	7S5FK083602001B18
	4 m	DD	dalex - BSB / CG Tuchel 5-pol.	High Flex Leder	7S5FH043602001B18
	8 m	DD	dalex - BSB / CG Tuchel 5-pol.	High Flex Leder	7S5FH083602001B18

Technische Änderungen vorbehalten • Verkaufspreise = unverbindliche Preisempfehlung - Angebot freibleibend • © Copyright

ABITIG® GRIP / ABITIG® GRIP Little-Brennerpreisliste

passend für WIG-Stromquellen des Fabrikates „dalex“

Brennertyp	Länge	Schalterfunktion	maschinenseitiger Anschluss	Schlauchpaketausführung	Bestellnummer
ABITIG® 12-1	4 m	DD	dalex - BSB / CG Tuchel 5-pol.	Standard	7S6SK043602001B18
	8 m	DD	dalex - BSB / CG Tuchel 5-pol.	Standard	7S6SK083602001B18
	4 m	DD	dalex - BSB / CG Tuchel 5-pol.	High Flex Leder	7S6SH043602001B18
	8 m	DD	dalex - BSB / CG Tuchel 5-pol.	High Flex Leder	7S6SH083602001B18
ABITIG® 18SC	4 m	DD	dalex - BSB / CG Tuchel 5-pol.	Standard	7S7SK043602001B18
	8 m	DD	dalex - BSB / CG Tuchel 5-pol.	Standard	7S7SK083602001B18
	4 m	DD	dalex - BSB / CG Tuchel 5-pol.	High Flex Leder	7S7SH043602001B18
	8 m	DD	dalex - BSB / CG Tuchel 5-pol.	High Flex Leder	7S7SH083602001B18
ABITIG® 24W	4 m	DD	dalex - BSB / CG Tuchel 5-pol.	Standard	7S9SK043602001B18
	8 m	DD	dalex - BSB / CG Tuchel 5-pol.	Standard	7S9SK083602001B18
	4 m	DD	dalex - BSB / CG Tuchel 5-pol.	High Flex Leder	7S9SH043602001B18
	8 m	DD	dalex - BSB / CG Tuchel 5-pol.	High Flex Leder	7S9SH083602001B18
ABITIG® 450W	4 m	DD	dalex - BSB / CG Tuchel 5-pol.	Standard	7T5SK043602001B18
	8 m	DD	dalex - BSB / CG Tuchel 5-pol.	Standard	7T5SK083602001B18
	4 m	DD	dalex - BSB / CG Tuchel 5-pol.	High Flex Leder	7T5SH043602001B18
	8 m	DD	dalex - BSB / CG Tuchel 5-pol.	High Flex Leder	7T5SH083602001B18
ABITIG® 260W	4 m	DD	dalex - BSB / CG Tuchel 5-pol.	Standard	7T7SK043602001B18
	8 m	DD	dalex - BSB / CG Tuchel 5-pol.	Standard	7T7SK083602001B18
	4 m	DD	dalex - BSB / CG Tuchel 5-pol.	High Flex Leder	7T7SH043602001B18
	8 m	DD	dalex - BSB / CG Tuchel 5-pol.	High Flex Leder	7T7SH083602001B18
ABITIG® 450W SC	4 m	DD	dalex - BSB / CG Tuchel 5-pol.	Standard	
	8 m	DD	dalex - BSB / CG Tuchel 5-pol.	Standard	
	4 m	DD	dalex - BSB / CG Tuchel 5-pol.	High Flex Leder	7T8SH043602001B18
	8 m	DD	dalex - BSB / CG Tuchel 5-pol.	High Flex Leder	7T8SH083602001B18

ABITIG® GRIP / ABITIG® GRIP Little-Brennerpreisliste

passend für WIG-Stromquellen des Fabrikates „dalex“

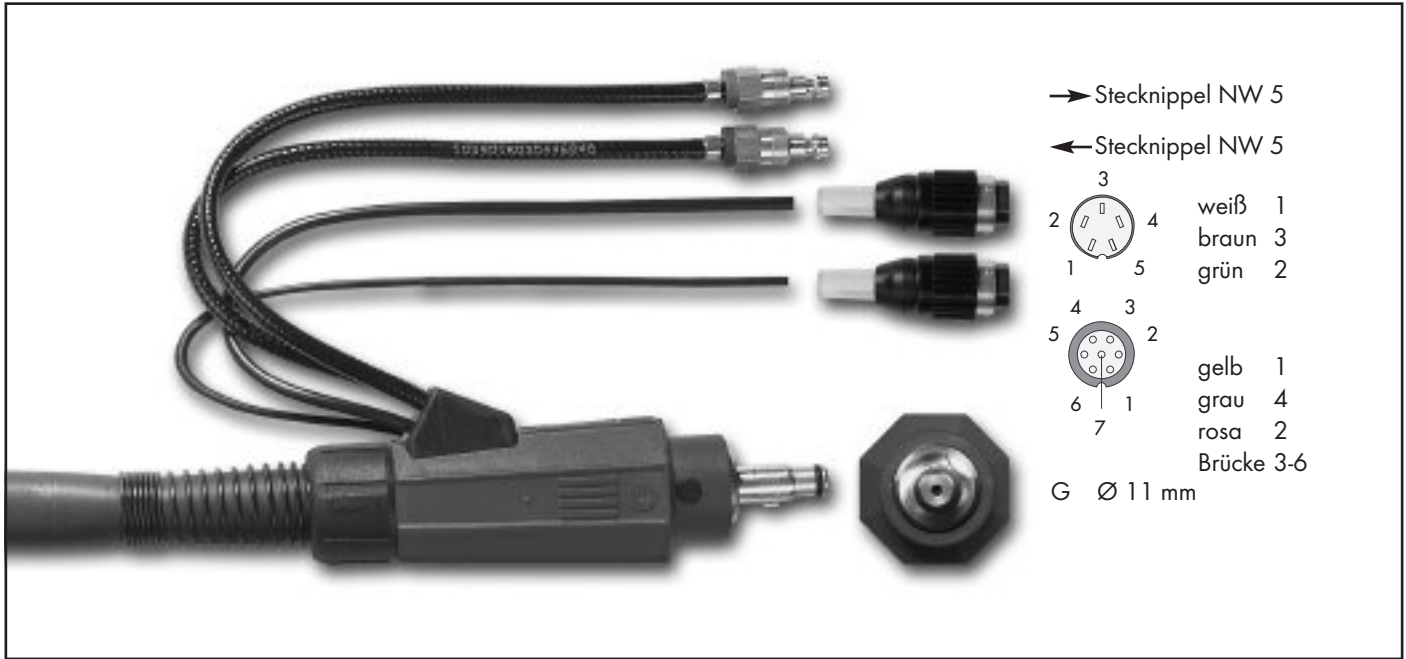

Brennertyp	Länge	Schalterfunktion	maschinenseitiger Anschluss	Schlauchpaketausführung	Bestellnummer
ABITIG® 18	4 m	DDP	dalex - BSB / CG Tuchel 5-pol. + Tuchel 7-pol.	Standard	7S4SK046542033A18
	8 m	DDP	dalex - BSB / CG Tuchel 5-pol. + Tuchel 7-pol.	Standard	7S4SK086542033A18
	4 m	DDP	dalex - BSB / CG Tuchel 5-pol. + Tuchel 7-pol.	High Flex Leder	7S4SH046542033A18
	8 m	DDP	dalex - BSB / CG Tuchel 5-pol. + Tuchel 7-pol.	High Flex Leder	7S4SH086542033A18
ABITIG® 18F	4 m	DDP	dalex - BSB / CG Tuchel 5-pol. + Tuchel 7-pol.	Standard	7S4FK046542033A18
	8 m	DDP	dalex - BSB / CG Tuchel 5-pol. + Tuchel 7-pol.	Standard	7S4FK086542033A18
	4 m	DDP	dalex - BSB / CG Tuchel 5-pol. + Tuchel 7-pol.	High Flex Leder	7S4FH046542033A18
	8 m	DDP	dalex - BSB / CG Tuchel 5-pol. + Tuchel 7-pol.	High Flex Leder	7S4FH086542033A18
ABITIG® 20	4 m	DDP	dalex - BSB / CG Tuchel 5-pol. + Tuchel 7-pol.	Standard	7S5SK046542033A18
	8 m	DDP	dalex - BSB / CG Tuchel 5-pol. + Tuchel 7-pol.	Standard	7S5SK086542033A18
	4 m	DDP	dalex - BSB / CG Tuchel 5-pol. + Tuchel 7-pol.	High Flex Leder	7S5SH046542033A18
	8 m	DDP	dalex - BSB / CG Tuchel 5-pol. + Tuchel 7-pol.	High Flex Leder	7S5SH086542033A18
ABITIG® 20F	4 m	DDP	dalex - BSB / CG Tuchel 5-pol. + Tuchel 7-pol.	Standard	7S5FK046542033A18
	8 m	DDP	dalex - BSB / CG Tuchel 5-pol. + Tuchel 7-pol.	Standard	7S5FK086542033A18
	4 m	DDP	dalex - BSB / CG Tuchel 5-pol. + Tuchel 7-pol.	High Flex Leder	7S5FH046542033A18
	8 m	DDP	dalex - BSB / CG Tuchel 5-pol. + Tuchel 7-pol.	High Flex Leder	7S5FH086542033A18

Technische Änderungen vorbehalten • Verkaufspreise = unverbindliche Preisempfehlung - Angebot freibleibend • © Copyright

ABITIG® GRIP / ABITIG® GRIP Little-Brennerpreisliste

passend für WIG-Stromquellen des Fabrikates „dalex“

Brennertyp	Länge	Schalterfunktion	maschinenseitiger Anschluss	Schlauchpaketausführung	Bestellnummer
ABITIG® 12-1	4 m	DDP	dalex - BSB / CG Tuchel 5-pol. + Tuchel 7-pol.	Standard	7S6SK046542033A18
	8 m	DDP	dalex - BSB / CG Tuchel 5-pol. + Tuchel 7-pol.	Standard	7S6SK086542033A18
	4 m	DDP	dalex - BSB / CG Tuchel 5-pol. + Tuchel 7-pol.	High Flex Leder	7S6SH046542033A18
	8 m	DDP	dalex - BSB / CG Tuchel 5-pol. + Tuchel 7-pol.	High Flex Leder	7S6SH086542033A18
ABITIG® 18SC	4 m	DDP	dalex - BSB / CG Tuchel 5-pol. + Tuchel 7-pol.	Standard	7S7SK046542033A18
	8 m	DDP	dalex - BSB / CG Tuchel 5-pol. + Tuchel 7-pol.	Standard	7S7SK086542033A18
	4 m	DDP	dalex - BSB / CG Tuchel 5-pol. + Tuchel 7-pol.	High Flex Leder	7S7SH046542033A18
	8 m	DDP	dalex - BSB / CG Tuchel 5-pol. + Tuchel 7-pol.	High Flex Leder	7S7SH086542033A18
ABITIG® 24W	4 m	DDP	dalex - BSB / CG Tuchel 5-pol. + Tuchel 7-pol.	Standard	7S9SK046542033A18
	8 m	DDP	dalex - BSB / CG Tuchel 5-pol. + Tuchel 7-pol.	Standard	7S9SK086542033A18
	4 m	DDP	dalex - BSB / CG Tuchel 5-pol. + Tuchel 7-pol.	High Flex Leder	7S9SH046542033A18
	8 m	DDP	dalex - BSB / CG Tuchel 5-pol. + Tuchel 7-pol.	High Flex Leder	7S9SH086542033A18
ABITIG® 450W	4 m	DDP	dalex - BSB / CG Tuchel 5-pol. + Tuchel 7-pol.	Standard	7T5SK046542033A18
	8 m	DDP	dalex - BSB / CG Tuchel 5-pol. + Tuchel 7-pol.	Standard	7T5SK086542033A18
	4 m	DDP	dalex - BSB / CG Tuchel 5-pol. + Tuchel 7-pol.	High Flex Leder	7T5SH046542033A18
	8 m	DDP	dalex - BSB / CG Tuchel 5-pol. + Tuchel 7-pol.	High Flex Leder	7T5SH086542033A18
ABITIG® 260W	4 m	DDP	dalex - BSB / CG Tuchel 5-pol. + Tuchel 7-pol.	Standard	7T7SK046542033A18
	8 m	DDP	dalex - BSB / CG Tuchel 5-pol. + Tuchel 7-pol.	Standard	7T7SK086542033A18
	4 m	DDP	dalex - BSB / CG Tuchel 5-pol. + Tuchel 7-pol.	High Flex Leder	7T7SH046542033A18
	8 m	DDP	dalex - BSB / CG Tuchel 5-pol. + Tuchel 7-pol.	High Flex Leder	7T7SH086542033A18
ABITIG® 450W SC	4 m	DDP	dalex - BSB / CG Tuchel 5-pol. + Tuchel 7-pol.	Standard	
	8 m	DDP	dalex - BSB / CG Tuchel 5-pol. + Tuchel 7-pol.	Standard	
	4 m	DDP	dalex - BSB / CG Tuchel 5-pol. + Tuchel 7-pol.	High Flex Leder	7T8SH046542033A18
	8 m	DDP	dalex - BSB / CG Tuchel 5-pol. + Tuchel 7-pol.	High Flex Leder	7T8SH086542033A18

ABITIG® GRIP / ABITIG® GRIP Little-Brennerpreisliste

passend für WIG-Stromquellen des Fabrikates „dalex“

Für dieses Gerätefabrikat ist in der Bestellnummer und somit auch im Lieferumfang das Ansteuermodul BIS-10 enthalten. Das Ansteuermodul BIS-10 enthält im Gegensatz zu BIS-02 die verstärkte Schalterausführung (2x) wegen der geräteabhängigen höheren Schaltströme.

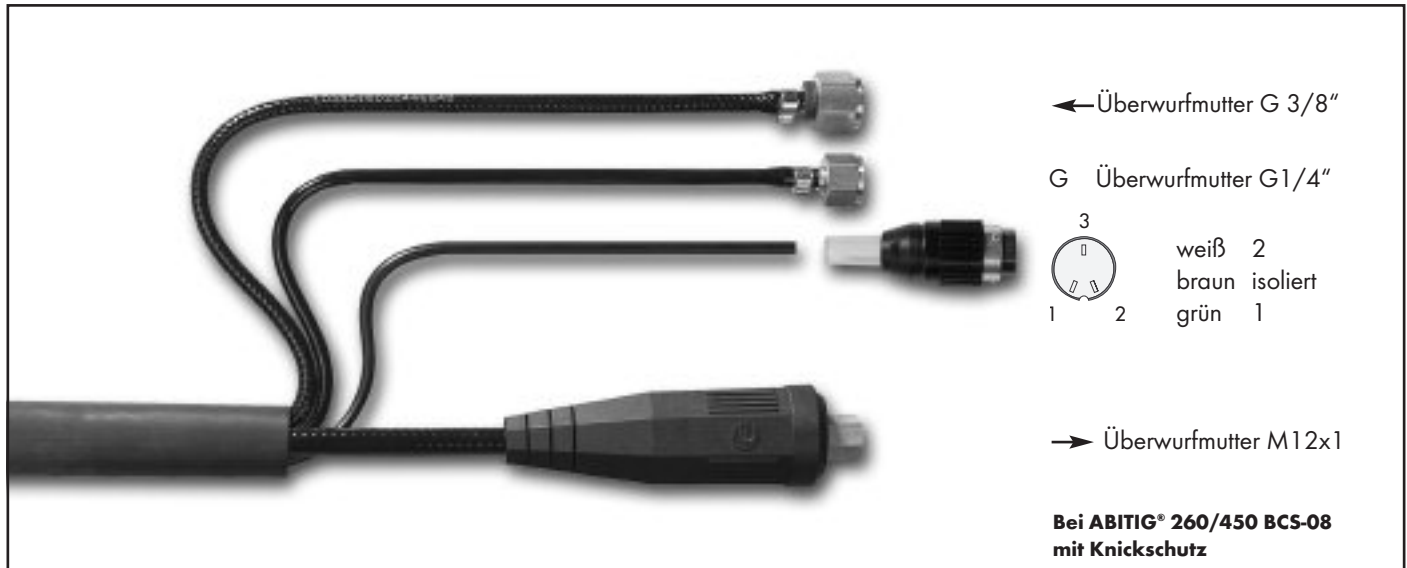

Brennertyp	Länge	Schalterfunktion	maschinenseitiger Anschluss	Schlauchpaketausführung	Bestellnummer
ABITIG® 18	4 m	ED	EA Tuchel 3-pol.	Standard	7S4SK043600813A15
	8 m	ED	EA Tuchel 3-pol.	Standard	7S4SK083600813A15
	4 m	ED	EA Tuchel 3-pol.	High Flex Leder	7S4SH043600813A15
	8 m	ED	EA Tuchel 3-pol.	High Flex Leder	7S4SH083600813A15
ABITIG® 18F	4 m	ED	EA Tuchel 3-pol.	Standard	7S4FK043600813A15
	8 m	ED	EA Tuchel 3-pol.	Standard	7S4FK083600813A15
	4 m	ED	EA Tuchel 3-pol.	High Flex Leder	7S4FH043600813A15
	8 m	ED	EA Tuchel 3-pol.	High Flex Leder	7S4FH083600813A15
ABITIG® 20	4 m	ED	EA Tuchel 3-pol.	Standard	7S5SK043600813A15
	8 m	ED	EA Tuchel 3-pol.	Standard	7S5SK083600813A15
	4 m	ED	EA Tuchel 3-pol.	High Flex Leder	7S5SH043600813A15
	8 m	ED	EA Tuchel 3-pol.	High Flex Leder	7S5SH083600813A15
ABITIG® 20F	4 m	ED	EA Tuchel 3-pol.	Standard	7S5FK043600813A15
	8 m	ED	EA Tuchel 3-pol.	Standard	7S5FK083600813A15
	4 m	ED	EA Tuchel 3-pol.	High Flex Leder	7S5FH043600813A15
	8 m	ED	EA Tuchel 3-pol.	High Flex Leder	7S5FH083600813A15

Technische Änderungen vorbehalten • Verkaufspreise = unverbindliche Preisempfehlung - Angebot freibleibend • © Copyright

ABITIG® GRIP / ABITIG® GRIP Little-Brennerpreisliste

passend für WIG-Stromquellen des Fabrikates „dalex“

Brennertyp	Länge	Schalterfunktion	maschinenseitiger Anschluss	Schlauchpaketausführung	Bestellnummer
ABITIG® 12-1	4 m	ED	EA Tuchel 3-pol.	Standard	7S6SK043600813A15
	8 m	ED	EA Tuchel 3-pol.	Standard	7S6SK083600813A15
	4 m	ED	EA Tuchel 3-pol.	High Flex Leder	7S6SH043600813A15
	8 m	ED	EA Tuchel 3-pol.	High Flex Leder	7S6SH083600813A15
ABITIG® 18SC	4 m	ED	EA Tuchel 3-pol.	Standard	7S7SK043600813A15
	8 m	ED	EA Tuchel 3-pol.	Standard	7S7SK083600813A15
	4 m	ED	EA Tuchel 3-pol.	High Flex Leder	7S7SH043600813A15
	8 m	ED	EA Tuchel 3-pol.	High Flex Leder	7S7SH083600813A15
ABITIG® 24W	4 m	ED	EA Tuchel 3-pol.	Standard	7S9SK043600813A15
	8 m	ED	EA Tuchel 3-pol.	Standard	7S9SK083600813A15
	4 m	ED	EA Tuchel 3-pol.	High Flex Leder	7S9SH043600813A15
	8 m	ED	EA Tuchel 3-pol.	High Flex Leder	7S9SH083600813A15
ABITIG® 450W	4 m	ED	EA Tuchel 3-pol.	Standard	7T5SK043600813A15
	8 m	ED	EA Tuchel 3-pol.	Standard	7T5SK083600813A15
	4 m	ED	EA Tuchel 3-pol.	High Flex Leder	7T5SH043600813A15
	8 m	ED	EA Tuchel 3-pol.	High Flex Leder	7T5SH083600813A15
ABITIG® 260W	4 m	ED	EA Tuchel 3-pol.	Standard	7T7SK043600813A15
	8 m	ED	EA Tuchel 3-pol.	Standard	7T7SK083600813A15
	4 m	ED	EA Tuchel 3-pol.	High Flex Leder	7T7SH043600813A15
	8 m	ED	EA Tuchel 3-pol.	High Flex Leder	7T7SH083600813A15
ABITIG® 450W SC	4 m	ED	EA Tuchel 3-pol.	Standard	
	8 m	ED	EA Tuchel 3-pol.	Standard	
	4 m	ED	EA Tuchel 3-pol.	High Flex Leder	7T8SH043600813A15
	8 m	ED	EA Tuchel 3-pol.	High Flex Leder	7T8SH083600813A15

ABITIG® GRIP / ABITIG® GRIP Little-Brennerpreisliste

passend für WIG-Stromquellen des Fabrikates „elekra-beckum“



Brennertyp	Länge	Schalterfunktion	maschinenseitiger Anschluss	Schlauchpaketausführung	Bestellnummer
ABITIG® 9	4 m	DD	BSB 10-25 Stecker 7-pol.	Standard	7S1SK043522217A06
	8 m	DD	BSB 10-25 Stecker 7-pol.	Standard	7S1SK083522217A06
	4 m	DD	BSB 10-25 Stecker 7-pol.	High Flex Leder	7S1SH043522217A06
	8 m	DD	BSB 10-25 Stecker 7-pol.	High Flex Leder	7S1SH083522217A06
ABITIG® 9 Little	4 m	DD	BSB 10-25 Stecker 7-pol.	High Flex Leder	7L1SH043522217A06
	8 m	DD	BSB 10-25 Stecker 7-pol.	High Flex Leder	7L1SH083522217A06
ABITIG® 9F	4 m	DD	BSB 10-25 Stecker 7-pol.	Standard	7S1FK043522217A06
	8 m	DD	BSB 10-25 Stecker 7-pol.	Standard	7S1FK083522217A06
	4 m	DD	BSB 10-25 Stecker 7-pol.	High Flex Leder	7S1FH043522217A06
	8 m	DD	BSB 10-25 Stecker 7-pol.	High Flex Leder	7S1FH083522217A06
ABITIG® 9F Little	4 m	DD	BSB 10-25 Stecker 7-pol.	High Flex Leder	7L1FH043522217A06
	8 m	DD	BSB 10-25 Stecker 7-pol.	High Flex Leder	7L1FH083522217A06
ABITIG® 17	4 m	DD	BSB 10-25 Stecker 7-pol.	Standard	7S2SK043522217A06
	8 m	DD	BSB 10-25 Stecker 7-pol.	Standard	7S2SK083522217A06
	4 m	DD	BSB 10-25 Stecker 7-pol.	High Flex Leder	7S2SH043522217A06
	8 m	DD	BSB 10-25 Stecker 7-pol.	High Flex Leder	7S2SH083522217A06
ABITIG® 17 Little	4 m	DD	BSB 10-25 Stecker 7-pol.	High Flex Leder	7L2SH043522217A06
	8 m	DD	BSB 10-25 Stecker 7-pol.	High Flex Leder	7L2SH083522217A06
ABITIG® 17F	4 m	DD	BSB 10-25 Stecker 7-pol.	Standard	7S2FK043522217A06
	8 m	DD	BSB 10-25 Stecker 7-pol.	Standard	7S2FK083522217A06
	4 m	DD	BSB 10-25 Stecker 7-pol.	High Flex Leder	7S2FH043522217A06
	8 m	DD	BSB 10-25 Stecker 7-pol.	High Flex Leder	7S2FH083522217A06
ABITIG® 17F Little	4 m	DD	BSB 10-25 Stecker 7-pol.	High Flex Leder	7L2FH043522217A06
	8 m	DD	BSB 10-25 Stecker 7-pol.	High Flex Leder	7L2FH083522217A06

Technische Änderungen vorbehalten • Verkaufspreise = unverbindliche Preisempfehlung - Angebot freibleibend • © Copyright

ABITIG® GRIP / ABITIG® GRIP Little-Brennerpreisliste

passend für WIG-Stromquellen des Fabrikates „elektro-beckum“

Brennertyp	Länge	Schalterfunktion	maschinenseitiger Anschluss	Schlauchpaketausführung	Bestellnummer
ABITIG® 26					
ABITIG® 26F					
ABITIG® 24G					
	4 m	DD	BSB 10-25 Stecker 7-pol.	Standard	7S8SK043522217A06
	8 m	DD	BSB 10-25 Stecker 7-pol.	Standard	7S8SK083522217A06
	4 m	DD	BSB 10-25 Stecker 7-pol.	High Flex Leder	7S8SH043522217A06
	8 m	DD	BSB 10-25 Stecker 7-pol.	High Flex Leder	7S8SH083522217A06
ABITIG® 24G Little					
	4 m	DD	BSB 10-25 Stecker 7-pol.	High Flex Leder	7L8SH043522217A06
	8 m	DD	BSB 10-25 Stecker 7-pol.	High Flex Leder	7L8SH083522217A06
ABITIG® 200					
ABITIG® 200F					
ABITIG® 150					
	4 m	DD	BSB 10-25 Stecker 7-pol.	Standard	7T6SK043522217A06
	8 m	DD	BSB 10-25 Stecker 7-pol.	Standard	7T6SK083522217A06
	4 m	DD	BSB 10-25 Stecker 7-pol.	High Flex Leder	7T6SH043522217A06
	8 m	DD	BSB 10-25 Stecker 7-pol.	High Flex Leder	7T6SH083522217A06
ABITIG® 150 Little					
	4 m	DD	BSB 10-25 Stecker 7-pol.	High Flex Leder	7L6SH043522217A06
	8 m	DD	BSB 10-25 Stecker 7-pol.	High Flex Leder	7L6SH083522217A06
ABITIG® 150F					
	4 m	DD	BSB 10-25 Stecker 7-pol.	Standard	7T6FK043522217A06
	8 m	DD	BSB 10-25 Stecker 7-pol.	Standard	7T6FK083522217A06
	4 m	DD	BSB 10-25 Stecker 7-pol.	High Flex Leder	7T6FH043522217A06
	8 m	DD	BSB 10-25 Stecker 7-pol.	High Flex Leder	7T6FH083522217A06
ABITIG® 150F Little					
	4 m	DD	BSB 10-25 Stecker 7-pol.	High Flex Leder	7L6FH043522217A06
	8 m	DD	BSB 10-25 Stecker 7-pol.	High Flex Leder	7L6FH083522217A06

ABITIG® GRIP / ABITIG® GRIP Little-Brennerpreisliste

passend für WIG-Stromquellen des Fabrikates „elekra-beckum“



Brennertyp	Länge	Schalterfunktion	maschinenseitiger Anschluss	Schlauchpaketausführung	Bestellnummer
ABITIG® 9	4 m	DD	BSB 35-50 Stecker 7-pol.	Standard	7S1SK043520017A06
	8 m	DD	BSB 35-50 Stecker 7-pol.	Standard	7S1SK083520017A06
	4 m	DD	BSB 35-50 Stecker 7-pol.	High Flex Leder	7S1SH043520017A06
	8 m	DD	BSB 35-50 Stecker 7-pol.	High Flex Leder	7S1SH083520017A06
ABITIG® 9 Little	4 m	DD	BSB 35-50 Stecker 7-pol.	High Flex Leder	7L1SH043520017A06
	8 m	DD	BSB 35-50 Stecker 7-pol.	High Flex Leder	7L1SH083520017A06
ABITIG® 9F	4 m	DD	BSB 35-50 Stecker 7-pol.	Standard	7S1FK043520017A06
	8 m	DD	BSB 35-50 Stecker 7-pol.	Standard	7S1FK083520017A06
	4 m	DD	BSB 35-50 Stecker 7-pol.	High Flex Leder	7S1FH043520017A06
	8 m	DD	BSB 35-50 Stecker 7-pol.	High Flex Leder	7S1FH083520017A06
ABITIG® 9F Little	4 m	DD	BSB 35-50 Stecker 7-pol.	High Flex Leder	7L1FH043520017A06
	8 m	DD	BSB 35-50 Stecker 7-pol.	High Flex Leder	7L1FH083520017A06
ABITIG® 17	4 m	DD	BSB 35-50 Stecker 7-pol.	Standard	7S2SK043520017A06
	8 m	DD	BSB 35-50 Stecker 7-pol.	Standard	7S2SK083520017A06
	4 m	DD	BSB 35-50 Stecker 7-pol.	High Flex Leder	7S2SH043520017A06
	8 m	DD	BSB 35-50 Stecker 7-pol.	High Flex Leder	7S2SH083520017A06
ABITIG® 17 Little	4 m	DD	BSB 35-50 Stecker 7-pol.	High Flex Leder	7L2SH043520017A06
	8 m	DD	BSB 35-50 Stecker 7-pol.	High Flex Leder	7L2SH083520017A06
ABITIG® 17F	4 m	DD	BSB 35-50 Stecker 7-pol.	Standard	7S2FK043520017A06
	8 m	DD	BSB 35-50 Stecker 7-pol.	Standard	7S2FK083520017A06
	4 m	DD	BSB 35-50 Stecker 7-pol.	High Flex Leder	7S2FH043520017A06
	8 m	DD	BSB 35-50 Stecker 7-pol.	High Flex Leder	7S2FH083520017A06
ABITIG® 17F Little	4 m	DD	BSB 35-50 Stecker 7-pol.	High Flex Leder	7L2FH043520017A06
	8 m	DD	BSB 35-50 Stecker 7-pol.	High Flex Leder	7L2FH083520017A06

Technische Änderungen vorbehalten • Verkaufspreise = unverbindliche Preisempfehlung - Angebot freibleibend • © Copyright

ABITIG® GRIP / ABITIG® GRIP Little-Brennerpreisliste

passend für WIG-Stromquellen des Fabrikates „elektro-beckum“

Brennertyp	Länge	Schalterfunktion	maschinenseitiger Anschluss	Schlauchpaketausführung	Bestellnummer
ABITIG® 26	4 m	DD	BSB 35-50 Stecker 7-pol.	Standard	7S3SK043520017A06
	8 m	DD	BSB 35-50 Stecker 7-pol.	Standard	7S3SK083520017A06
	4 m	DD	BSB 35-50 Stecker 7-pol.	High Flex Leder	7S3SH043520017A06
	8 m	DD	BSB 35-50 Stecker 7-pol.	High Flex Leder	7S3SH083520017A06
ABITIG® 26F	4 m	DD	BSB 35-50 Stecker 7-pol.	Standard	7S3FK043520017A06
	8 m	DD	BSB 35-50 Stecker 7-pol.	Standard	7S3FK083520017A06
	4 m	DD	BSB 35-50 Stecker 7-pol.	High Flex Leder	7S3FH043520017A06
	8 m	DD	BSB 35-50 Stecker 7-pol.	High Flex Leder	7S3FH083520017A06
ABITIG® 24G	4 m	DD	BSB 35-50 Stecker 7-pol.	Standard	7S8SK043520017A06
	8 m	DD	BSB 35-50 Stecker 7-pol.	Standard	7S8SK083520017A06
	4 m	DD	BSB 35-50 Stecker 7-pol.	High Flex Leder	7S8SH043520017A06
	8 m	DD	BSB 35-50 Stecker 7-pol.	High Flex Leder	7S8SH083520017A06
ABITIG® 24G Little	4 m	DD	BSB 35-50 Stecker 7-pol.	High Flex Leder	7L8SH043520017A06
	8 m	DD	BSB 35-50 Stecker 7-pol.	High Flex Leder	7L8SH083520017A06
ABITIG® 200	4 m	DD	BSB 35-50 Stecker 7-pol.	Standard	7T4SK043520017A06
	8 m	DD	BSB 35-50 Stecker 7-pol.	Standard	7T4SK083520017A06
	4 m	DD	BSB 35-50 Stecker 7-pol.	High Flex Leder	7T4SH043520017A06
	8 m	DD	BSB 35-50 Stecker 7-pol.	High Flex Leder	7T4SH083520017A06
ABITIG® 200 Little	4 m	DD	BSB 35-50 Stecker 7-pol.	High Flex Leder	7L4SH043520017A06
	8 m	DD	BSB 35-50 Stecker 7-pol.	High Flex Leder	7L4SH083520017A06
ABITIG® 200F	4 m	DD	BSB 35-50 Stecker 7-pol.	Standard	7T4FK043520017A06
	8 m	DD	BSB 35-50 Stecker 7-pol.	Standard	7T4FK083520017A06
	4 m	DD	BSB 35-50 Stecker 7-pol.	High Flex Leder	7T4FH043520017A06
	8 m	DD	BSB 35-50 Stecker 7-pol.	High Flex Leder	7T4FH083520017A06
ABITIG® 200F Little	4 m	DD	BSB 35-50 Stecker 7-pol.	High Flex Leder	7L4FH043520017A06
	8 m	DD	BSB 35-50 Stecker 7-pol.	High Flex Leder	7L4FH083520017A06
ABITIG® 150	4 m	DD	BSB 35-50 Stecker 7-pol.	Standard	7T6SK043520017A06
	8 m	DD	BSB 35-50 Stecker 7-pol.	Standard	7T6SK083520017A06
	4 m	DD	BSB 35-50 Stecker 7-pol.	High Flex Leder	7T6SH043520017A06
	8 m	DD	BSB 35-50 Stecker 7-pol.	High Flex Leder	7T6SH083520017A06
ABITIG® 150 Little	4 m	DD	BSB 35-50 Stecker 7-pol.	High Flex Leder	7L6SH043520017A06
	8 m	DD	BSB 35-50 Stecker 7-pol.	High Flex Leder	7L6SH083520017A06
ABITIG® 150F	4 m	DD	BSB 35-50 Stecker 7-pol.	Standard	7T6FK043520017A06
	8 m	DD	BSB 35-50 Stecker 7-pol.	Standard	7T6FK083520017A06
	4 m	DD	BSB 35-50 Stecker 7-pol.	High Flex Leder	7T6FH043520017A06
	8 m	DD	BSB 35-50 Stecker 7-pol.	High Flex Leder	7T6FH083520017A06
ABITIG® 150F Little	4 m	DD	BSB 35-50 Stecker 7-pol.	High Flex Leder	7L6FH043520017A06
	8 m	DD	BSB 35-50 Stecker 7-pol.	High Flex Leder	7L6FH083520017A06

ABITIG® GRIP / ABITIG® GRIP Little-Brennerpreisliste

passend für WIG-Stromquellen des Fabrikates „elekra-beckum“



Brennertyp	Länge	Schalterfunktion	maschinenseitiger Anschluss	Schlauchpaketausführung	Bestellnummer
ABITIG® 9	4 m	DDP	BSB 10-25 Stecker 7-pol.	Standard	7S1SK046542219A06
	8 m	DDP	BSB 10-25 Stecker 7-pol.	Standard	7S1SK086542219A06
	4 m	DDP	BSB 10-25 Stecker 7-pol.	High Flex Leder	7S1SH046542219A06
	8 m	DDP	BSB 10-25 Stecker 7-pol.	High Flex Leder	7S1SH086542219A06
ABITIG® 9F	4 m	DDP	BSB 10-25 Stecker 7-pol.	Standard	7S1FK046542219A06
	8 m	DDP	BSB 10-25 Stecker 7-pol.	Standard	7S1FK086542219A06
	4 m	DDP	BSB 10-25 Stecker 7-pol.	High Flex Leder	7S1FH046542219A06
	8 m	DDP	BSB 10-25 Stecker 7-pol.	High Flex Leder	7S1FH086542219A06
ABITIG® 17	4 m	DDP	BSB 10-25 Stecker 7-pol.	Standard	7S2SK046542219A06
	8 m	DDP	BSB 10-25 Stecker 7-pol.	Standard	7S2SK086542219A06
	4 m	DDP	BSB 10-25 Stecker 7-pol.	High Flex Leder	7S2SH046542219A06
	8 m	DDP	BSB 10-25 Stecker 7-pol.	High Flex Leder	7S2SH086542219A06
ABITIG® 17F	4 m	DDP	BSB 10-25 Stecker 7-pol.	Standard	7S2FK046542219A06
	8 m	DDP	BSB 10-25 Stecker 7-pol.	Standard	7S2FK086542219A06
	4 m	DDP	BSB 10-25 Stecker 7-pol.	High Flex Leder	7S2FH046542219A06
	8 m	DDP	BSB 10-25 Stecker 7-pol.	High Flex Leder	7S2FH086542219A06

Technische Änderungen vorbehalten • Verkaufspreise = unverbindliche Preisempfehlung - Angebot freibleibend • © Copyright

ABITIG® GRIP / ABITIG® GRIP Little-Brennerpreisliste

passend für WIG-Stromquellen des Fabrikates „elekra-beckum“

Brennertyp	Länge	Schalterfunktion	maschinenseitiger Anschluss	Schlauchpaketausführung	Bestellnummer
------------	-------	------------------	-----------------------------	-------------------------	---------------

ABITIG® 26

ABITIG® 26F

ABITIG® 24G	4 m	DDP	BSB 10-25 Stecker 7-pol.	Standard	7S8SK046542219A06
	8 m	DDP	BSB 10-25 Stecker 7-pol.	Standard	7S8SK086542219A06
	4 m	DDP	BSB 10-25 Stecker 7-pol.	High Flex Leder	7S8SH046542219A06
	8 m	DDP	BSB 10-25 Stecker 7-pol.	High Flex Leder	7S8SH086542219A06

ABITIG® 200

ABITIG® 200F

ABITIG® 150	4 m	DDP	BSB 10-25 Stecker 7-pol.	Standard	7T6SK046542219A06
	8 m	DDP	BSB 10-25 Stecker 7-pol.	Standard	7T6SK086542219A06
	4 m	DDP	BSB 10-25 Stecker 7-pol.	High Flex Leder	7T6SH046542219A06
	8 m	DDP	BSB 10-25 Stecker 7-pol.	High Flex Leder	7T6SH086542219A06

ABITIG® 150F	4 m	DDP	BSB 10-25 Stecker 7-pol.	Standard	7T6FK046542219A06
	8 m	DDP	BSB 10-25 Stecker 7-pol.	Standard	7T6FK086542219A06
	4 m	DDP	BSB 10-25 Stecker 7-pol.	High Flex Leder	7T6FH046542219A06
	8 m	DDP	BSB 10-25 Stecker 7-pol.	High Flex Leder	7T6FH086542219A06

ABITIG® GRIP / ABITIG® GRIP Little-Brennerpreisliste

passend für WIG-Stromquellen des Fabrikates „elekra-beckum“



Brennertyp	Länge	Schalterfunktion	maschinenseitiger Anschluss	Schlauchpaketausführung	Bestellnummer
ABITIG® 9	4 m	DDP	BSB 35-50 Stecker 7-pol.	Standard	7S1SK046540019A06
	8 m	DDP	BSB 35-50 Stecker 7-pol.	Standard	7S1SK086540019A06
	4 m	DDP	BSB 35-50 Stecker 7-pol.	High Flex Leder	7S1SH046540019A06
	8 m	DDP	BSB 35-50 Stecker 7-pol.	High Flex Leder	7S1SH086540019A06
ABITIG® 9F	4 m	DDP	BSB 35-50 Stecker 7-pol.	Standard	7S1FK046540019A06
	8 m	DDP	BSB 35-50 Stecker 7-pol.	Standard	7S1FK086540019A06
	4 m	DDP	BSB 35-50 Stecker 7-pol.	High Flex Leder	7S1FH046540019A06
	8 m	DDP	BSB 35-50 Stecker 7-pol.	High Flex Leder	7S1FH086540019A06
ABITIG® 17	4 m	DDP	BSB 35-50 Stecker 7-pol.	Standard	7S2SK046540019A06
	8 m	DDP	BSB 35-50 Stecker 7-pol.	Standard	7S2SK086540019A06
	4 m	DDP	BSB 35-50 Stecker 7-pol.	High Flex Leder	7S2SH046540019A06
	8 m	DDP	BSB 35-50 Stecker 7-pol.	High Flex Leder	7S2SH086540019A06
ABITIG® 17F	4 m	DDP	BSB 35-50 Stecker 7-pol.	Standard	7S2FK046540019A06
	8 m	DDP	BSB 35-50 Stecker 7-pol.	Standard	7S2FK086540019A06
	4 m	DDP	BSB 35-50 Stecker 7-pol.	High Flex Leder	7S2FH046540019A06
	8 m	DDP	BSB 35-50 Stecker 7-pol.	High Flex Leder	7S2FH086540019A06

Technische Änderungen vorbehalten • Verkaufspreise = unverbindliche Preisempfehlung - Angebot freibleibend • © Copyright

ABITIG® GRIP / ABITIG® GRIP Little-Brennerpreisliste

passend für WIG-Stromquellen des Fabrikates „elekra-beckum“

Brennertyp	Länge	Schalterfunktion	maschinenseitiger Anschluss	Schlauchpaketausführung	Bestellnummer
ABITIG® 26	4 m	DDP	BSB 35-50 Stecker 7-pol.	Standard	7S3SK046540019A06
	8 m	DDP	BSB 35-50 Stecker 7-pol.	Standard	7S3SK086540019A06
	4 m	DDP	BSB 35-50 Stecker 7-pol.	High Flex Leder	7S3SH046540019A06
	8 m	DDP	BSB 35-50 Stecker 7-pol.	High Flex Leder	7S3SH086540019A06
ABITIG® 26F	4 m	DDP	BSB 35-50 Stecker 7-pol.	Standard	7S3FK046540019A06
	8 m	DDP	BSB 35-50 Stecker 7-pol.	Standard	7S3FK086540019A06
	4 m	DDP	BSB 35-50 Stecker 7-pol.	High Flex Leder	7S3FH046540019A06
	8 m	DDP	BSB 35-50 Stecker 7-pol.	High Flex Leder	7S3FH086540019A06
ABITIG® 24G	4 m	DDP	BSB 35-50 Stecker 7-pol.	Standard	7S8SK046540019A06
	8 m	DDP	BSB 35-50 Stecker 7-pol.	Standard	7S8SK086540019A06
	4 m	DDP	BSB 35-50 Stecker 7-pol.	High Flex Leder	7S8SH046540019A06
	8 m	DDP	BSB 35-50 Stecker 7-pol.	High Flex Leder	7S8SH086540019A06
ABITIG® 200	4 m	DDP	BSB 35-50 Stecker 7-pol.	Standard	7T4SK046540019A06
	8 m	DDP	BSB 35-50 Stecker 7-pol.	Standard	7T4SK086540019A06
	4 m	DDP	BSB 35-50 Stecker 7-pol.	High Flex Leder	7T4SH046540019A06
	8 m	DDP	BSB 35-50 Stecker 7-pol.	High Flex Leder	7T4SH086540019A06
ABITIG® 200F	4 m	DDP	BSB 35-50 Stecker 7-pol.	Standard	7T4FK046540019A06
	8 m	DDP	BSB 35-50 Stecker 7-pol.	Standard	7T4FK086540019A06
	4 m	DDP	BSB 35-50 Stecker 7-pol.	High Flex Leder	7T4FH046540019A06
	8 m	DDP	BSB 35-50 Stecker 7-pol.	High Flex Leder	7T4FH086540019A06
ABITIG® 150	4 m	DDP	BSB 35-50 Stecker 7-pol.	Standard	7T6SK046540019A06
	8 m	DDP	BSB 35-50 Stecker 7-pol.	Standard	7T6SK086540019A06
	4 m	DDP	BSB 35-50 Stecker 7-pol.	High Flex Leder	7T6SH046540019A06
	8 m	DDP	BSB 35-50 Stecker 7-pol.	High Flex Leder	7T6SH086540019A06
ABITIG® 150F	4 m	DDP	BSB 35-50 Stecker 7-pol.	Standard	7T6FK046540019A06
	8 m	DDP	BSB 35-50 Stecker 7-pol.	Standard	7T6FK086540019A06
	4 m	DDP	BSB 35-50 Stecker 7-pol.	High Flex Leder	7T6FH046540019A06
	8 m	DDP	BSB 35-50 Stecker 7-pol.	High Flex Leder	7T6FH086540019A06

ABITIG® GRIP / ABITIG® GRIP Little-Brennerpreisliste

passend für WIG-Stromquellen des Fabrikates „elekra-beckum“



Brennertyp	Länge	Schalterfunktion	maschinenseitiger Anschluss	Schlauchpaketausführung	Bestellnummer
ABITIG® 18	4 m	DD	BSB 35-50 Stecker 7-pol.	Standard	7S4SK043520017A20
	8 m	DD	BSB 35-50 Stecker 7-pol.	Standard	7S4SK083520017A20
	4 m	DD	BSB 35-50 Stecker 7-pol.	High Flex Leder	7S4SH043520017A20
	8 m	DD	BSB 35-50 Stecker 7-pol.	High Flex Leder	7S4SH083520017A20
ABITIG® 18F	4 m	DD	BSB 35-50 Stecker 7-pol.	Standard	7S4FK043520017A20
	8 m	DD	BSB 35-50 Stecker 7-pol.	Standard	7S4FK083520017A20
	4 m	DD	BSB 35-50 Stecker 7-pol.	High Flex Leder	7S4FH043520017A20
	8 m	DD	BSB 35-50 Stecker 7-pol.	High Flex Leder	7S4FH083520017A20
ABITIG® 20	4 m	DD	BSB 35-50 Stecker 7-pol.	Standard	7S5SK043520017A20
	8 m	DD	BSB 35-50 Stecker 7-pol.	Standard	7S5SK083520017A20
	4 m	DD	BSB 35-50 Stecker 7-pol.	High Flex Leder	7S5SH043520017A20
	8 m	DD	BSB 35-50 Stecker 7-pol.	High Flex Leder	7S5SH083520017A20
ABITIG® 20 Little	4 m	DD	BSB 35-50 Stecker 7-pol.	High Flex Leder	7L5SH043520017A20
	8 m	DD	BSB 35-50 Stecker 7-pol.	High Flex Leder	7L5SH083520017A20
ABITIG® 20F	4 m	DD	BSB 35-50 Stecker 7-pol.	Standard	7S5FK043520017A20
	8 m	DD	BSB 35-50 Stecker 7-pol.	Standard	7S5FK083520017A20
	4 m	DD	BSB 35-50 Stecker 7-pol.	High Flex Leder	7S5FH043520017A20
	8 m	DD	BSB 35-50 Stecker 7-pol.	High Flex Leder	7S5FH083520017A20
ABITIG® 20F Little	4 m	DD	BSB 35-50 Stecker 7-pol.	High Flex Leder	7L5FH043520017A20
	8 m	DD	BSB 35-50 Stecker 7-pol.	High Flex Leder	7L5FH083520017A20

Technische Änderungen vorbehalten • Verkaufspreise = unverbindliche Preisempfehlung - Angebot freibleibend • © Copyright

ABITIG® GRIP / ABITIG® GRIP Little-Brennerpreisliste

passend für WIG-Stromquellen des Fabrikates „elektro-beckum“

Brennertyp	Länge	Schalterfunktion	maschinenseitiger Anschluss	Schlauchpaketausführung	Bestellnummer
ABITIG® 12-1	4 m	DD	BSB 35-50 Stecker 7-pol.	Standard	7S6SK043520017A20
	8 m	DD	BSB 35-50 Stecker 7-pol.	Standard	7S6SK083520017A20
	4 m	DD	BSB 35-50 Stecker 7-pol.	High Flex Leder	7S6SH043520017A20
	8 m	DD	BSB 35-50 Stecker 7-pol.	High Flex Leder	7S6SH083520017A20
ABITIG® 18SC	4 m	DD	BSB 35-50 Stecker 7-pol.	Standard	7S7SK043520017A20
	8 m	DD	BSB 35-50 Stecker 7-pol.	Standard	7S7SK083520017A20
	4 m	DD	BSB 35-50 Stecker 7-pol.	High Flex Leder	7S7SH043520017A20
	8 m	DD	BSB 35-50 Stecker 7-pol.	High Flex Leder	7S7SH083520017A20
ABITIG® 24W	4 m	DD	BSB 35-50 Stecker 7-pol.	Standard	7S9SK043520017A20
	8 m	DD	BSB 35-50 Stecker 7-pol.	Standard	7S9SK083520017A20
	4 m	DD	BSB 35-50 Stecker 7-pol.	High Flex Leder	7S9SH043520017A20
	8 m	DD	BSB 35-50 Stecker 7-pol.	High Flex Leder	7S9SH083520017A20
ABITIG® 24W Little	4 m	DD	BSB 35-50 Stecker 7-pol.	High Flex Leder	7L9SH043520017A20
	8 m	DD	BSB 35-50 Stecker 7-pol.	High Flex Leder	7L9SH083520017A20
ABITIG® 450W	4 m	DD	BSB 35-50 Stecker 7-pol.	Standard	7T5SK043520117A20
	8 m	DD	BSB 35-50 Stecker 7-pol.	Standard	7T5SK083520117A20
	4 m	DD	BSB 35-50 Stecker 7-pol.	High Flex Leder	7T5SH043520117A20
	8 m	DD	BSB 35-50 Stecker 7-pol.	High Flex Leder	7T5SH083520117A20
ABITIG® 260W	4 m	DD	BSB 35-50 Stecker 7-pol.	Standard	7T7SK043520117A20
	8 m	DD	BSB 35-50 Stecker 7-pol.	Standard	7T7SK083520117A20
	4 m	DD	BSB 35-50 Stecker 7-pol.	High Flex Leder	7T7SH043520117A20
	8 m	DD	BSB 35-50 Stecker 7-pol.	High Flex Leder	7T7SH083520117A20
ABITIG® 260W Little	4 m	DD	BSB 35-50 Stecker 7-pol.	High Flex Leder	7L7SH043520117A20
	8 m	DD	BSB 35-50 Stecker 7-pol.	High Flex Leder	7L7SH083520117A20
ABITIG® 450W SC	4 m	DD	BSB 35-50 Stecker 7-pol.	Standard	
	8 m	DD	BSB 35-50 Stecker 7-pol.	Standard	
	4 m	DD	BSB 35-50 Stecker 7-pol.	High Flex Leder	7T8SH043520117A20
	8 m	DD	BSB 35-50 Stecker 7-pol.	High Flex Leder	7T8SH083520117A20

ABITIG® GRIP / ABITIG® GRIP Little-Brennerpreisliste

passend für WIG-Stromquellen des Fabrikates „elekra-beckum“

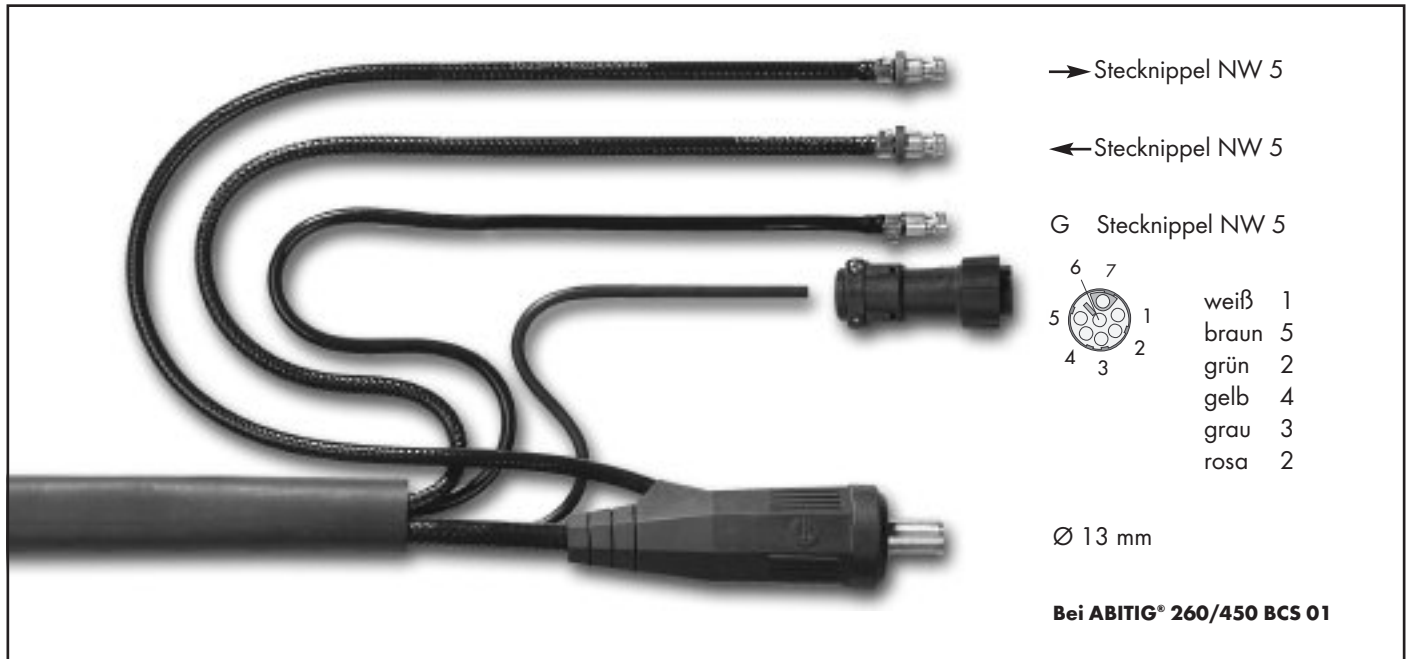

Brennertyp	Länge	Schalterfunktion	maschinenseitiger Anschluss	Schlauchpaketausführung	Bestellnummer
ABITIG® 18	4 m	DDP	BSB 35-50 Stecker 7-pol.	Standard	7S4SK046540019A20
	8 m	DDP	BSB 35-50 Stecker 7-pol.	Standard	7S4SK086540019A20
	4 m	DDP	BSB 35-50 Stecker 7-pol.	High Flex Leder	7S4SH046540019A20
	8 m	DDP	BSB 35-50 Stecker 7-pol.	High Flex Leder	7S4SH086540019A20
ABITIG® 18F	4 m	DDP	BSB 35-50 Stecker 7-pol.	Standard	7S4FK046540019A20
	8 m	DDP	BSB 35-50 Stecker 7-pol.	Standard	7S4FK086540019A20
	4 m	DDP	BSB 35-50 Stecker 7-pol.	High Flex Leder	7S4FH046540019A20
	8 m	DDP	BSB 35-50 Stecker 7-pol.	High Flex Leder	7S4FH086540019A20
ABITIG® 20	4 m	DDP	BSB 35-50 Stecker 7-pol.	Standard	7S5SK046540019A20
	8 m	DDP	BSB 35-50 Stecker 7-pol.	Standard	7S5SK086540019A20
	4 m	DDP	BSB 35-50 Stecker 7-pol.	High Flex Leder	7S5SH046540019A20
	8 m	DDP	BSB 35-50 Stecker 7-pol.	High Flex Leder	7S5SH086540019A20
ABITIG® 20F	4 m	DDP	BSB 35-50 Stecker 7-pol.	Standard	7S5FK046540019A20
	8 m	DDP	BSB 35-50 Stecker 7-pol.	Standard	7S5FK086540019A20
	4 m	DDP	BSB 35-50 Stecker 7-pol.	High Flex Leder	7S5FH046540019A20
	8 m	DDP	BSB 35-50 Stecker 7-pol.	High Flex Leder	7S5FH086540019A20

Technische Änderungen vorbehalten • Verkaufspreise = unverbindliche Preisempfehlung - Angebot freibleibend • © Copyright

ABITIG® GRIP / ABITIG® GRIP Little-Brennerpreisliste

passend für WIG-Stromquellen des Fabrikates „elektro-beckum“

Brennertyp	Länge	Schalterfunktion	maschinenseitiger Anschluss	Schlauchpaketausführung	Bestellnummer
ABITIG® 12-1	4 m	DDP	BSB 35-50 Stecker 7-pol.	Standard	7S6SK046540019A20
	8 m	DDP	BSB 35-50 Stecker 7-pol.	Standard	7S6SK086540019A20
	4 m	DDP	BSB 35-50 Stecker 7-pol.	High Flex Leder	7S6SH046540019A20
	8 m	DDP	BSB 35-50 Stecker 7-pol.	High Flex Leder	7S6SH086540019A20
ABITIG® 18SC	4 m	DDP	BSB 35-50 Stecker 7-pol.	Standard	7S7SK046540019A20
	8 m	DDP	BSB 35-50 Stecker 7-pol.	Standard	7S7SK086540019A20
	4 m	DDP	BSB 35-50 Stecker 7-pol.	High Flex Leder	7S7SH046540019A20
	8 m	DDP	BSB 35-50 Stecker 7-pol.	High Flex Leder	7S7SH086540019A20
ABITIG® 24W	4 m	DDP	BSB 35-50 Stecker 7-pol.	Standard	7S9SK046540019A20
	8 m	DDP	BSB 35-50 Stecker 7-pol.	Standard	7S9SK086540019A20
	4 m	DDP	BSB 35-50 Stecker 7-pol.	High Flex Leder	7S9SH046540019A20
	8 m	DDP	BSB 35-50 Stecker 7-pol.	High Flex Leder	7S9SH086540019A20
ABITIG® 450W	4 m	DDP	BSB 35-50 Stecker 7-pol.	Standard	7T5SK046540119A20
	8 m	DDP	BSB 35-50 Stecker 7-pol.	Standard	7T5SK086540119A20
	4 m	DDP	BSB 35-50 Stecker 7-pol.	High Flex Leder	7T5SH046540119A20
	8 m	DDP	BSB 35-50 Stecker 7-pol.	High Flex Leder	7T5SH086540119A20
ABITIG® 260W	4 m	DDP	BSB 35-50 Stecker 7-pol.	Standard	7T7SK046540119A20
	8 m	DDP	BSB 35-50 Stecker 7-pol.	Standard	7T7SK086540119A20
	4 m	DDP	BSB 35-50 Stecker 7-pol.	High Flex Leder	7T7SH046540119A20
	8 m	DDP	BSB 35-50 Stecker 7-pol.	High Flex Leder	7T7SH086540119A20
ABITIG® 450W SC	4 m	DDP	BSB 35-50 Stecker 7-pol.	Standard	
	8 m	DDP	BSB 35-50 Stecker 7-pol.	Standard	
	4 m	DDP	BSB 35-50 Stecker 7-pol.	High Flex Leder	7T8SH046540119A20
	8 m	DDP	BSB 35-50 Stecker 7-pol.	High Flex Leder	7T8SH086540119A20

ABITIG® GRIP / ABITIG® GRIP Little-Brennerpreisliste

passend für WIG-Stromquellen des Fabrikates „esab“



Brennertyp	Länge	Schalterfunktion	maschinenseitiger Anschluss	Schlauchpaketausführung	Bestellnummer
ABITIG® 9	4 m	ED	ZA 9-pol.	Standard	7S1SK047510799A00
	8 m	ED	ZA 9-pol.	Standard	7S1SK087510799A00
	4 m	ED	ZA 9-pol.	High Flex Leder	7S1SH047510799A00
	8 m	ED	ZA 9-pol.	High Flex Leder	7S1SH087510799A00
ABITIG® 9 Little	4 m	ED	ZA 9-pol.	High Flex Leder	7L1SH047510799A00
	8 m	ED	ZA 9-pol.	High Flex Leder	7L1SH087510799A00
ABITIG® 9F	4 m	ED	ZA 9-pol.	Standard	7S1FK047510799A00
	8 m	ED	ZA 9-pol.	Standard	7S1FK087510799A00
	4 m	ED	ZA 9-pol.	High Flex Leder	7S1FH047510799A00
	8 m	ED	ZA 9-pol.	High Flex Leder	7S1FH087510799A00
ABITIG® 9F Little	4 m	ED	ZA 9-pol.	High Flex Leder	7L1FH047510799A00
	8 m	ED	ZA 9-pol.	High Flex Leder	7L1FH087510799A00
ABITIG® 17	4 m	ED	ZA 9-pol.	Standard	7S2SK047510799A00
	8 m	ED	ZA 9-pol.	Standard	7S2SK087510799A00
	4 m	ED	ZA 9-pol.	High Flex Leder	7S2SH047510799A00
	8 m	ED	ZA 9-pol.	High Flex Leder	7S2SH087510799A00
ABITIG® 17 Little	4 m	ED	ZA 9-pol.	High Flex Leder	7L2SH047510799A00
	8 m	ED	ZA 9-pol.	High Flex Leder	7L2SH087510799A00
ABITIG® 17F	4 m	ED	ZA 9-pol.	Standard	7S2FK047510799A00
	8 m	ED	ZA 9-pol.	Standard	7S2FK087510799A00
	4 m	ED	ZA 9-pol.	High Flex Leder	7S2FH047510799A00
	8 m	ED	ZA 9-pol.	High Flex Leder	7S2FH087510799A00
ABITIG® 17F Little	4 m	ED	ZA 9-pol.	High Flex Leder	7L2FH047510799A00
	8 m	ED	ZA 9-pol.	High Flex Leder	7L2FH087510799A00

Technische Änderungen vorbehalten • Verkaufspreise = unverbindliche Preisempfehlung - Angebot freibleibend • © Copyright

ABITIG® GRIP / ABITIG® GRIP Little-Brennerpreisliste

passend für WIG-Stromquellen des Fabrikates „esab“

Brennertyp	Länge	Schalterfunktion	maschinenseitiger Anschluss	Schlauchpaketausführung	Bestellnummer
ABITIG® 26	4 m	ED	ZA 9-pol.	Standard	7S3SK047510799A00
	8 m	ED	ZA 9-pol.	Standard	7S3SK087510799A00
	4 m	ED	ZA 9-pol.	High Flex Leder	7S3SH047510799A00
	8 m	ED	ZA 9-pol.	High Flex Leder	7S3SH087510799A00
ABITIG® 26F	4 m	ED	ZA 9-pol.	Standard	7S3FK047510799A00
	8 m	ED	ZA 9-pol.	Standard	7S3FK087510799A00
	4 m	ED	ZA 9-pol.	High Flex Leder	7S3FH047510799A00
	8 m	ED	ZA 9-pol.	High Flex Leder	7S3FH087510799A00
ABITIG® 24G	4 m	ED	ZA 9-pol.	Standard	7S8SK047510799A00
	8 m	ED	ZA 9-pol.	Standard	7S8SK087510799A00
	4 m	ED	ZA 9-pol.	High Flex Leder	7S8SH047510799A00
	8 m	ED	ZA 9-pol.	High Flex Leder	7S8SH087510799A00
ABITIG® 24G Little	4 m	ED	ZA 9-pol.	High Flex Leder	7L8SH047510799A00
	8 m	ED	ZA 9-pol.	High Flex Leder	7L8SH087510799A00
ABITIG® 200	4 m	ED	ZA 9-pol.	Standard	7T4SK047510799A00
	8 m	ED	ZA 9-pol.	Standard	7T4SK087510799A00
	4 m	ED	ZA 9-pol.	High Flex Leder	7T4SH047510799A00
	8 m	ED	ZA 9-pol.	High Flex Leder	7T4SH087510799A00
ABITIG® 200F	4 m	ED	ZA 9-pol.	Standard	7T4FK047510799A00
	8 m	ED	ZA 9-pol.	Standard	7T4FK087510799A00
	4 m	ED	ZA 9-pol.	High Flex Leder	7T4FH047510799A00
	8 m	ED	ZA 9-pol.	High Flex Leder	7T4FH087510799A00
ABITIG® 150	4 m	ED	ZA 9-pol.	Standard	7T6SK047510799A00
	8 m	ED	ZA 9-pol.	Standard	7T6SK087510799A00
	4 m	ED	ZA 9-pol.	High Flex Leder	7T6SH047510799A00
	8 m	ED	ZA 9-pol.	High Flex Leder	7T6SH087510799A00
ABITIG® 150 Little	4 m	ED	ZA 9-pol.	High Flex Leder	7L6SH047510799A00
	8 m	ED	ZA 9-pol.	High Flex Leder	7L6SH087510799A00
ABITIG® 150F	4 m	ED	ZA 9-pol.	Standard	7T6FK047510799A00
	8 m	ED	ZA 9-pol.	Standard	7T6FK087510799A00
	4 m	ED	ZA 9-pol.	High Flex Leder	7T6FH047510799A00
	8 m	ED	ZA 9-pol.	High Flex Leder	7T6FH087510799A00
ABITIG® 150F Little	4 m	ED	ZA 9-pol.	High Flex Leder	7L6FH047510799A00
	8 m	ED	ZA 9-pol.	High Flex Leder	7L6FH087510799A00

ABITIG® GRIP / ABITIG® GRIP Little-Brennerpreisliste

passend für WIG-Stromquellen des Fabrikates „esab“



Brennertyp	Länge	Schalterfunktion	maschinenseitiger Anschluss	Schlauchpaketausführung	Bestellnummer
ABITIG® 9	4 m	ED	BSB 35-50 Amphenol 2-pol.	Standard	7S1SK047510009A03
	8 m	ED	BSB 35-50 Amphenol 2-pol.	Standard	7S1SK087510009A03
	4 m	ED	BSB 35-50 Amphenol 2-pol.	High Flex Leder	7S1SH047510009A03
	8 m	ED	BSB 35-50 Amphenol 2-pol.	High Flex Leder	7S1SH087510009A03
ABITIG® 9 Little	4 m	ED	BSB 35-50 Amphenol 2-pol.	High Flex Leder	7L1SH047510009A03
	8 m	ED	BSB 35-50 Amphenol 2-pol.	High Flex Leder	7L1SH087510009A03
ABITIG® 9F	4 m	ED	BSB 35-50 Amphenol 2-pol.	Standard	7S1FK047510009A03
	8 m	ED	BSB 35-50 Amphenol 2-pol.	Standard	7S1FK087510009A03
	4 m	ED	BSB 35-50 Amphenol 2-pol.	High Flex Leder	7S1FH047510009A03
	8 m	ED	BSB 35-50 Amphenol 2-pol.	High Flex Leder	7S1FH087510009A03
ABITIG® 9F Little	4 m	ED	BSB 35-50 Amphenol 2-pol.	High Flex Leder	7L1FH047510009A03
	8 m	ED	BSB 35-50 Amphenol 2-pol.	High Flex Leder	7L1FH087510009A03
ABITIG® 17	4 m	ED	BSB 35-50 Amphenol 2-pol.	Standard	7S2SK047510009A03
	8 m	ED	BSB 35-50 Amphenol 2-pol.	Standard	7S2SK087510009A03
	4 m	ED	BSB 35-50 Amphenol 2-pol.	High Flex Leder	7S2SH047510009A03
	8 m	ED	BSB 35-50 Amphenol 2-pol.	High Flex Leder	7S2SH087510009A03
ABITIG® 17 Little	4 m	ED	BSB 35-50 Amphenol 2-pol.	High Flex Leder	7L2SH047510009A03
	8 m	ED	BSB 35-50 Amphenol 2-pol.	High Flex Leder	7L2SH087510009A03
ABITIG® 17F	4 m	ED	BSB 35-50 Amphenol 2-pol.	Standard	7S2FK047510009A03
	8 m	ED	BSB 35-50 Amphenol 2-pol.	Standard	7S2FK087510009A03
	4 m	ED	BSB 35-50 Amphenol 2-pol.	High Flex Leder	7S2FH047510009A03
	8 m	ED	BSB 35-50 Amphenol 2-pol.	High Flex Leder	7S2FH087510009A03
ABITIG® 17F Little	4 m	ED	BSB 35-50 Amphenol 2-pol.	High Flex Leder	7L2FH047510009A03
	8 m	ED	BSB 35-50 Amphenol 2-pol.	High Flex Leder	7L2FH087510009A03

Technische Änderungen vorbehalten • Verkaufspreise = unverbindliche Preisempfehlung - Angebot freibleibend • © Copyright

ABITIG® GRIP / ABITIG® GRIP Little-Brennerpreisliste

passend für WIG-Stromquellen des Fabrikates „esab“

Brennertyp	Länge	Schalterfunktion	maschinenseitiger Anschluss	Schlauchpaketausführung	Bestellnummer
ABITIG® 26	4 m	ED	BSB 35-50 Amphenol 2-pol.	Standard	7S3SK047510009A03
	8 m	ED	BSB 35-50 Amphenol 2-pol.	Standard	7S3SK087510009A03
	4 m	ED	BSB 35-50 Amphenol 2-pol.	High Flex Leder	7S3SH047510009A03
	8 m	ED	BSB 35-50 Amphenol 2-pol.	High Flex Leder	7S3SH087510009A03
ABITIG® 26F	4 m	ED	BSB 35-50 Amphenol 2-pol.	Standard	7S3FK047510009A03
	8 m	ED	BSB 35-50 Amphenol 2-pol.	Standard	7S3FK087510009A03
	4 m	ED	BSB 35-50 Amphenol 2-pol.	High Flex Leder	7S3FH047510009A03
	8 m	ED	BSB 35-50 Amphenol 2-pol.	High Flex Leder	7S3FH087510009A03
ABITIG® 24G	4 m	ED	BSB 35-50 Amphenol 2-pol.	Standard	7S8SK047510009A03
	8 m	ED	BSB 35-50 Amphenol 2-pol.	Standard	7S8SK087510009A03
	4 m	ED	BSB 35-50 Amphenol 2-pol.	High Flex Leder	7S8SH047510009A03
	8 m	ED	BSB 35-50 Amphenol 2-pol.	High Flex Leder	7S8SH087510009A03
ABITIG® 24G Little	4 m	ED	BSB 35-50 Amphenol 2-pol.	High Flex Leder	7L8SH047510009A03
	8 m	ED	BSB 35-50 Amphenol 2-pol.	High Flex Leder	7L8SH087510009A03
ABITIG® 200	4 m	ED	BSB 35-50 Amphenol 2-pol.	Standard	7T4SK047510009A03
	8 m	ED	BSB 35-50 Amphenol 2-pol.	Standard	7T4SK087510009A03
	4 m	ED	BSB 35-50 Amphenol 2-pol.	High Flex Leder	7T4SH047510009A03
	8 m	ED	BSB 35-50 Amphenol 2-pol.	High Flex Leder	7T4SH087510009A03
ABITIG® 200F	4 m	ED	BSB 35-50 Amphenol 2-pol.	Standard	7T4FK047510009A03
	8 m	ED	BSB 35-50 Amphenol 2-pol.	Standard	7T4FK087510009A03
	4 m	ED	BSB 35-50 Amphenol 2-pol.	High Flex Leder	7T4FH047510009A03
	8 m	ED	BSB 35-50 Amphenol 2-pol.	High Flex Leder	7T4FH087510009A03
ABITIG® 150	4 m	ED	BSB 35-50 Amphenol 2-pol.	Standard	7T6SK047510009A03
	8 m	ED	BSB 35-50 Amphenol 2-pol.	Standard	7T6SK087510009A03
	4 m	ED	BSB 35-50 Amphenol 2-pol.	High Flex Leder	7T6SH047510009A03
	8 m	ED	BSB 35-50 Amphenol 2-pol.	High Flex Leder	7T6SH087510009A03
ABITIG® 150 Little	4 m	ED	BSB 35-50 Amphenol 2-pol.	High Flex Leder	7L6SH047510009A03
	8 m	ED	BSB 35-50 Amphenol 2-pol.	High Flex Leder	7L6SH087510009A03
ABITIG® 150F	4 m	ED	BSB 35-50 Amphenol 2-pol.	Standard	7T6FK047510009A03
	8 m	ED	BSB 35-50 Amphenol 2-pol.	Standard	7T6FK087510009A03
	4 m	ED	BSB 35-50 Amphenol 2-pol.	High Flex Leder	7T6FH047510009A03
	8 m	ED	BSB 35-50 Amphenol 2-pol.	High Flex Leder	7T6FH087510009A03
ABITIG® 150F Little	4 m	ED	BSB 35-50 Amphenol 2-pol.	High Flex Leder	7L6FH047510009A03
	8 m	ED	BSB 35-50 Amphenol 2-pol.	High Flex Leder	7L6FH087510009A03

ABITIG® GRIP / ABITIG® GRIP Little-Brennerpreisliste

passend für WIG-Stromquellen des Fabrikates „esab“

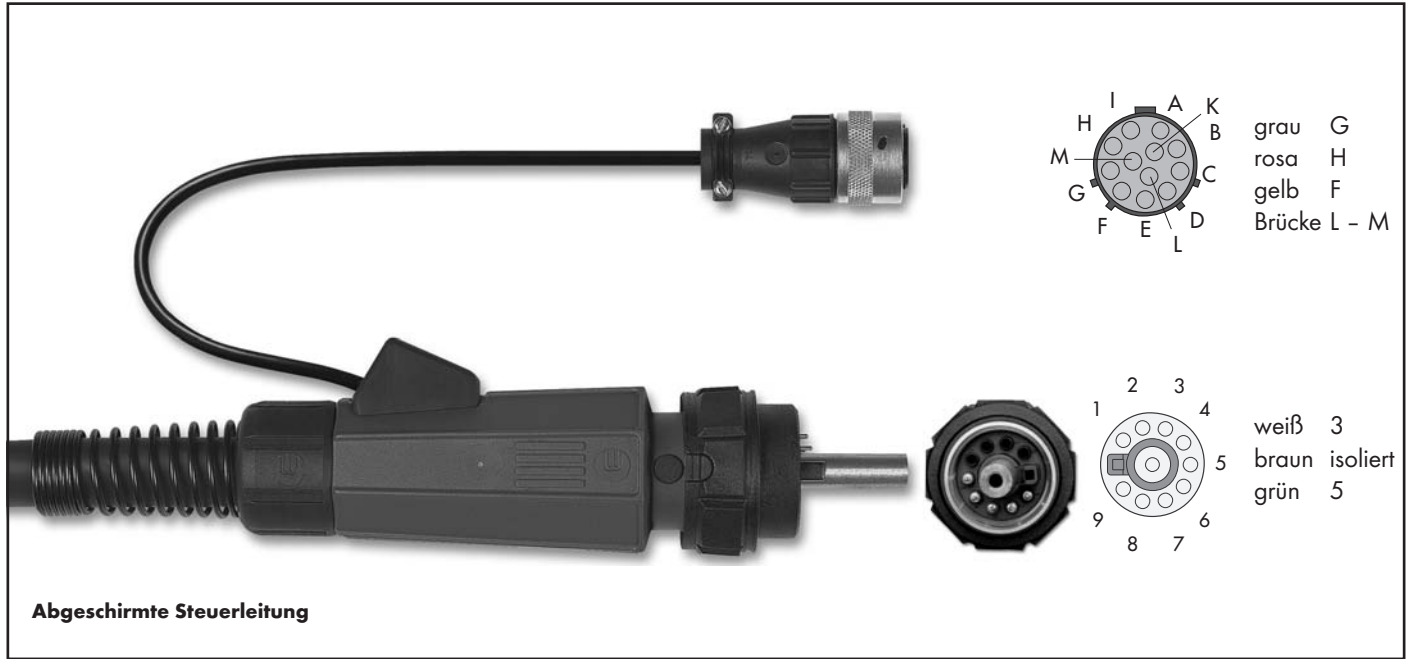

Brennertyp	Länge	Schalterfunktion	maschinenseitiger Anschluss	Schlauchpaketausführung	Bestellnummer
ABITIG® 9	4 m	EDP	ZA 9-pol./Burndy 12-pol.	Standard	7S1SK047540739A00
	8 m	EDP	ZA 9-pol./Burndy 12-pol.	Standard	7S1SK087540739A00
	4 m	EDP	ZA 9-pol./Burndy 12-pol.	High Flex Leder	7S1SH047540739A00
	8 m	EDP	ZA 9-pol./Burndy 12-pol.	High Flex Leder	7S1SH087540739A00
ABITIG® 9F	4 m	EDP	ZA 9-pol./Burndy 12-pol.	Standard	7S1FK047540739A00
	8 m	EDP	ZA 9-pol./Burndy 12-pol.	Standard	7S1FK087540739A00
	4 m	EDP	ZA 9-pol./Burndy 12-pol.	High Flex Leder	7S1FH047540739A00
	8 m	EDP	ZA 9-pol./Burndy 12-pol.	High Flex Leder	7S1FH087540739A00
ABITIG® 17	4 m	EDP	ZA 9-pol./Burndy 12-pol.	Standard	7S2SK047540739A00
	8 m	EDP	ZA 9-pol./Burndy 12-pol.	Standard	7S2SK087540739A00
	4 m	EDP	ZA 9-pol./Burndy 12-pol.	High Flex Leder	7S2SH047540739A00
	8 m	EDP	ZA 9-pol./Burndy 12-pol.	High Flex Leder	7S2SH087540739A00
ABITIG® 17F	4 m	EDP	ZA 9-pol./Burndy 12-pol.	Standard	7S2FK047540739A00
	8 m	EDP	ZA 9-pol./Burndy 12-pol.	Standard	7S2FK087540739A00
	4 m	EDP	ZA 9-pol./Burndy 12-pol.	High Flex Leder	7S2FH047540739A00
	8 m	EDP	ZA 9-pol./Burndy 12-pol.	High Flex Leder	7S2FH087540739A00

Technische Änderungen vorbehalten • Verkaufspreise = unverbindliche Preisempfehlung - Angebot freibleibend • © Copyright

ABITIG® GRIP / ABITIG® GRIP Little-Brennerpreisliste

passend für WIG-Stromquellen des Fabrikates „esab“

Brennertyp	Länge	Schalterfunktion	maschinenseitiger Anschluss	Schlauchpaketausführung	Bestellnummer
ABITIG® 26	4 m	EDP	ZA 9-pol./Burndy 12-pol.	Standard	7S3SK047540739A00
	8 m	EDP	ZA 9-pol./Burndy 12-pol.	Standard	7S3SK087540739A00
	4 m	EDP	ZA 9-pol./Burndy 12-pol.	High Flex Leder	7S3SH047540739A00
	8 m	EDP	ZA 9-pol./Burndy 12-pol.	High Flex Leder	7S3SH087540739A00
ABITIG® 26F	4 m	EDP	ZA 9-pol./Burndy 12-pol.	Standard	7S3FK047540739A00
	8 m	EDP	ZA 9-pol./Burndy 12-pol.	Standard	7S3FK087540739A00
	4 m	EDP	ZA 9-pol./Burndy 12-pol.	High Flex Leder	7S3FH047540739A00
	8 m	EDP	ZA 9-pol./Burndy 12-pol.	High Flex Leder	7S3FH087540739A00
ABITIG® 24G	4 m	EDP	ZA 9-pol./Burndy 12-pol.	Standard	7S8SK047540739A00
	8 m	EDP	ZA 9-pol./Burndy 12-pol.	Standard	7S8SK087540739A00
	4 m	EDP	ZA 9-pol./Burndy 12-pol.	High Flex Leder	7S8SH047540739A00
	8 m	EDP	ZA 9-pol./Burndy 12-pol.	High Flex Leder	7S8SH087540739A00
ABITIG® 200	4 m	EDP	ZA 9-pol./Burndy 12-pol.	Standard	7T4SK047540739A00
	8 m	EDP	ZA 9-pol./Burndy 12-pol.	Standard	7T4SK087540739A00
	4 m	EDP	ZA 9-pol./Burndy 12-pol.	High Flex Leder	7T4SH047540739A00
	8 m	EDP	ZA 9-pol./Burndy 12-pol.	High Flex Leder	7T4SH087540739A00
ABITIG® 200F	4 m	EDP	ZA 9-pol./Burndy 12-pol.	Standard	7T4FK047540739A00
	8 m	EDP	ZA 9-pol./Burndy 12-pol.	Standard	7T4FK087540739A00
	4 m	EDP	ZA 9-pol./Burndy 12-pol.	High Flex Leder	7T4FH047540739A00
	8 m	EDP	ZA 9-pol./Burndy 12-pol.	High Flex Leder	7T4FH087540739A00
ABITIG® 150	4 m	EDP	ZA 9-pol./Burndy 12-pol.	Standard	7T6SK047540739A00
	8 m	EDP	ZA 9-pol./Burndy 12-pol.	Standard	7T6SK087540739A00
	4 m	EDP	ZA 9-pol./Burndy 12-pol.	High Flex Leder	7T6SH047540739A00
	8 m	EDP	ZA 9-pol./Burndy 12-pol.	High Flex Leder	7T6SH087540739A00
ABITIG® 150F	4 m	EDP	ZA 9-pol./Burndy 12-pol.	Standard	7T6FK047540739A00
	8 m	EDP	ZA 9-pol./Burndy 12-pol.	Standard	7T6FK087540739A00
	4 m	EDP	ZA 9-pol./Burndy 12-pol.	High Flex Leder	7T6FH047540739A00
	8 m	EDP	ZA 9-pol./Burndy 12-pol.	High Flex Leder	7T6FH087540739A00

ABITIG® GRIP / ABITIG® GRIP Little-Brennerpreisliste

passend für WIG-Stromquellen des Fabrikates „esab“



Brennertyp	Länge	Schalterfunktion	maschinenseitiger Anschluss	Schlauchpaketausführung	Bestellnummer
ABITIG® 9	4 m	ED	BSB 10-25 Amphenol 2-pol.	Standard	7S1SK047512709A03
	8 m	ED	BSB 10-25 Amphenol 2-pol.	Standard	7S1SK087512709A03
	4 m	ED	BSB 10-25 Amphenol 2-pol.	High Flex Leder	7S1SH047512709A03
	8 m	ED	BSB 10-25 Amphenol 2-pol.	High Flex Leder	7S1SH087512709A03
ABITIG® 9 Little	4 m	ED	BSB 10-25 Amphenol 2-pol.	High Flex Leder	7L1SH047512709A03
	8 m	ED	BSB 10-25 Amphenol 2-pol.	High Flex Leder	7L1SH087512709A03
ABITIG® 9F	4 m	ED	BSB 10-25 Amphenol 2-pol.	Standard	7S1FK047512709A03
	8 m	ED	BSB 10-25 Amphenol 2-pol.	Standard	7S1FK087512709A03
	4 m	ED	BSB 10-25 Amphenol 2-pol.	High Flex Leder	7S1FH047512709A03
	8 m	ED	BSB 10-25 Amphenol 2-pol.	High Flex Leder	7S1FH087512709A03
ABITIG® 9F Little	4 m	ED	BSB 10-25 Amphenol 2-pol.	High Flex Leder	7L1FH047512709A03
	8 m	ED	BSB 10-25 Amphenol 2-pol.	High Flex Leder	7L1FH087512709A03
ABITIG® 17	4 m	ED	BSB 10-25 Amphenol 2-pol.	Standard	7S2SK047512709A03
	8 m	ED	BSB 10-25 Amphenol 2-pol.	Standard	7S2SK087512709A03
	4 m	ED	BSB 10-25 Amphenol 2-pol.	High Flex Leder	7S2SH047512709A03
	8 m	ED	BSB 10-25 Amphenol 2-pol.	High Flex Leder	7S2SH087512709A03
ABITIG® 17 Little	4 m	ED	BSB 10-25 Amphenol 2-pol.	High Flex Leder	7L2SH047512709A03
	8 m	ED	BSB 10-25 Amphenol 2-pol.	High Flex Leder	7L2SH087512709A03
ABITIG® 17F	4 m	ED	BSB 10-25 Amphenol 2-pol.	Standard	7S2FK047512709A03
	8 m	ED	BSB 10-25 Amphenol 2-pol.	Standard	7S2FK087512709A03
	4 m	ED	BSB 10-25 Amphenol 2-pol.	High Flex Leder	7S2FH047512709A03
	8 m	ED	BSB 10-25 Amphenol 2-pol.	High Flex Leder	7S2FH087512709A03
ABITIG® 17F Little	4 m	ED	BSB 10-25 Amphenol 2-pol.	High Flex Leder	7L2FH047512709A03
	8 m	ED	BSB 10-25 Amphenol 2-pol.	High Flex Leder	7L2FH087512709A03

Technische Änderungen vorbehalten • Verkaufspreise = unverbindliche Preisempfehlung - Angebot freibleibend • © Copyright

ABITIG® GRIP / ABITIG® GRIP Little-Brennerpreisliste

passend für WIG-Stromquellen des Fabrikates „esab“

Brennertyp	Länge	Schalterfunktion	maschinenseitiger Anschluss	Schlauchpaketausführung	Bestellnummer
ABITIG® 26	4 m	ED	BSB 10-25 Amphenol 2-pol.	Standard	7S3SK047512709A03
	8 m	ED	BSB 10-25 Amphenol 2-pol.	Standard	7S3SK087512709A03
	4 m	ED	BSB 10-25 Amphenol 2-pol.	High Flex Leder	7S3SH047512709A03
	8 m	ED	BSB 10-25 Amphenol 2-pol.	High Flex Leder	7S3SH087512709A03
ABITIG® 26F	4 m	ED	BSB 10-25 Amphenol 2-pol.	Standard	7S3FK047512709A03
	8 m	ED	BSB 10-25 Amphenol 2-pol.	Standard	7S3FK087512709A03
	4 m	ED	BSB 10-25 Amphenol 2-pol.	High Flex Leder	7S3FH047512709A03
	8 m	ED	BSB 10-25 Amphenol 2-pol.	High Flex Leder	7S3FH087512709A03
ABITIG® 24G	4 m	ED	BSB 10-25 Amphenol 2-pol.	Standard	7S8SK047512709A03
	8 m	ED	BSB 10-25 Amphenol 2-pol.	Standard	7S8SK087512709A03
	4 m	ED	BSB 10-25 Amphenol 2-pol.	High Flex Leder	7S8SH047512709A03
	8 m	ED	BSB 10-25 Amphenol 2-pol.	High Flex Leder	7S8SH087512709A03
ABITIG® 24G Little	4 m	ED	BSB 10-25 Amphenol 2-pol.	High Flex Leder	7L8SH047512709A03
	8 m	ED	BSB 10-25 Amphenol 2-pol.	High Flex Leder	7L8SH087512709A03
ABITIG® 200	4 m	ED	BSB 10-25 Amphenol 2-pol.	Standard	7T4SK047512709A03
	8 m	ED	BSB 10-25 Amphenol 2-pol.	Standard	7T4SK087512709A03
	4 m	ED	BSB 10-25 Amphenol 2-pol.	High Flex Leder	7T4SH047512709A03
	8 m	ED	BSB 10-25 Amphenol 2-pol.	High Flex Leder	7T4SH087512709A03
ABITIG® 200F	4 m	ED	BSB 10-25 Amphenol 2-pol.	Standard	7T4FK047512709A03
	8 m	ED	BSB 10-25 Amphenol 2-pol.	Standard	7T4FK087512709A03
	4 m	ED	BSB 10-25 Amphenol 2-pol.	High Flex Leder	7T4FH047512709A03
	8 m	ED	BSB 10-25 Amphenol 2-pol.	High Flex Leder	7T4FH087512709A03
ABITIG® 150	4 m	ED	BSB 10-25 Amphenol 2-pol.	Standard	7T6SK047512709A03
	8 m	ED	BSB 10-25 Amphenol 2-pol.	Standard	7T6SK087512709A03
	4 m	ED	BSB 10-25 Amphenol 2-pol.	High Flex Leder	7T6SH047512709A03
	8 m	ED	BSB 10-25 Amphenol 2-pol.	High Flex Leder	7T6SH087512709A03
ABITIG® 150 Little	4 m	ED	BSB 10-25 Amphenol 2-pol.	High Flex Leder	7L6SH047512709A03
	8 m	ED	BSB 10-25 Amphenol 2-pol.	High Flex Leder	7L6SH087512709A03
ABITIG® 150F	4 m	ED	BSB 10-25 Amphenol 2-pol.	Standard	7T6FK047512709A03
	8 m	ED	BSB 10-25 Amphenol 2-pol.	Standard	7T6FK087512709A03
	4 m	ED	BSB 10-25 Amphenol 2-pol.	High Flex Leder	7T6FH047512709A03
	8 m	ED	BSB 10-25 Amphenol 2-pol.	High Flex Leder	7T6FH087512709A03
ABITIG® 150F Little	4 m	ED	BSB 10-25 Amphenol 2-pol.	High Flex Leder	7L6FH047512709A03
	8 m	ED	BSB 10-25 Amphenol 2-pol.	High Flex Leder	7L6FH087512709A03

ABITIG® GRIP / ABITIG® GRIP Little-Brennerpreisliste

passend für WIG-Stromquellen des Fabrikates „esab“



Brennertyp	Länge	Schalterfunktion	maschinenseitiger Anschluss	Schlauchpaketausführung	Bestellnummer
ABITIG® 9	4 m	ED	BSB 10-25 Redelstecker 2-pol.	Standard	7S1SK047512754A05
	8 m	ED	BSB 10-25 Redelstecker 2-pol.	Standard	7S1SK087512754A05
	4 m	ED	BSB 10-25 Redelstecker 2-pol.	High Flex Leder	7S1SH047512754A05
	8 m	ED	BSB 10-25 Redelstecker 2-pol.	High Flex Leder	7S1SH087512754A05
ABITIG® 9 Little	4 m	ED	BSB 10-25 Redelstecker 2-pol.	High Flex Leder	7L1SH047512754A05
	8 m	ED	BSB 10-25 Redelstecker 2-pol.	High Flex Leder	7L1SH087512754A05
ABITIG® 9F	4 m	ED	BSB 10-25 Redelstecker 2-pol.	Standard	7S1FK047512754A05
	8 m	ED	BSB 10-25 Redelstecker 2-pol.	Standard	7S1FK087512754A05
	4 m	ED	BSB 10-25 Redelstecker 2-pol.	High Flex Leder	7S1FH047512754A05
	8 m	ED	BSB 10-25 Redelstecker 2-pol.	High Flex Leder	7S1FH087512754A05
ABITIG® 9F Little	4 m	ED	BSB 10-25 Redelstecker 2-pol.	High Flex Leder	7L1FH047512754A05
	8 m	ED	BSB 10-25 Redelstecker 2-pol.	High Flex Leder	7L1FH087512754A05
ABITIG® 17	4 m	ED	BSB 10-25 Redelstecker 2-pol.	Standard	7S2SK047512754A05
	8 m	ED	BSB 10-25 Redelstecker 2-pol.	Standard	7S2SK087512754A05
	4 m	ED	BSB 10-25 Redelstecker 2-pol.	High Flex Leder	7S2SH047512754A05
	8 m	ED	BSB 10-25 Redelstecker 2-pol.	High Flex Leder	7S2SH087512754A05
ABITIG® 17 Little	4 m	ED	BSB 10-25 Redelstecker 2-pol.	High Flex Leder	7L2SH047512754A05
	8 m	ED	BSB 10-25 Redelstecker 2-pol.	High Flex Leder	7L2SH087512754A05
ABITIG® 17F	4 m	ED	BSB 10-25 Redelstecker 2-pol.	Standard	7S2FK047512754A05
	8 m	ED	BSB 10-25 Redelstecker 2-pol.	Standard	7S2FK087512754A05
	4 m	ED	BSB 10-25 Redelstecker 2-pol.	High Flex Leder	7S2FH047512754A05
	8 m	ED	BSB 10-25 Redelstecker 2-pol.	High Flex Leder	7S2FH087512754A05
ABITIG® 17F Little	4 m	ED	BSB 10-25 Redelstecker 2-pol.	High Flex Leder	7L2FH047512754A05
	8 m	ED	BSB 10-25 Redelstecker 2-pol.	High Flex Leder	7L2FH087512754A05

Technische Änderungen vorbehalten • Verkaufspreise = unverbindliche Preisempfehlung - Angebot freibleibend • © Copyright

ABITIG® GRIP / ABITIG® GRIP Little-Brennerpreisliste

passend für WIG-Stromquellen des Fabrikates „esab“

Brennertyp	Länge	Schalterfunktion	maschinenseitiger Anschluss	Schlauchpaketausführung	Bestellnummer
ABITIG® 26	4 m	ED	BSB 10-25 Redelstecker 2-pol.	Standard	7S3SK047512754A05
	8 m	ED	BSB 10-25 Redelstecker 2-pol.	Standard	7S3SK087512754A05
	4 m	ED	BSB 10-25 Redelstecker 2-pol.	High Flex Leder	7S3SH047512754A05
	8 m	ED	BSB 10-25 Redelstecker 2-pol.	High Flex Leder	7S3SH087512754A05
ABITIG® 26F	4 m	ED	BSB 10-25 Redelstecker 2-pol.	Standard	7S3FK047512754A05
	8 m	ED	BSB 10-25 Redelstecker 2-pol.	Standard	7S3FK087512754A05
	4 m	ED	BSB 10-25 Redelstecker 2-pol.	High Flex Leder	7S3FH047512754A05
	8 m	ED	BSB 10-25 Redelstecker 2-pol.	High Flex Leder	7S3FH087512754A05
ABITIG® 24G	4 m	ED	BSB 10-25 Redelstecker 2-pol.	Standard	7S8SK047512754A05
	8 m	ED	BSB 10-25 Redelstecker 2-pol.	Standard	7S8SK087512754A05
	4 m	ED	BSB 10-25 Redelstecker 2-pol.	High Flex Leder	7S8SH047512754A05
	8 m	ED	BSB 10-25 Redelstecker 2-pol.	High Flex Leder	7S8SH087512754A05
ABITIG® 24G Little	4 m	ED	BSB 10-25 Redelstecker 2-pol.	High Flex Leder	7L8SH047512754A05
	8 m	ED	BSB 10-25 Redelstecker 2-pol.	High Flex Leder	7L8SH087512754A05
ABITIG® 200	4 m	ED	BSB 10-25 Redelstecker 2-pol.	Standard	7T4SK047512754A05
	8 m	ED	BSB 10-25 Redelstecker 2-pol.	Standard	7T4SK087512754A05
	4 m	ED	BSB 10-25 Redelstecker 2-pol.	High Flex Leder	7T4SH047512754A05
	8 m	ED	BSB 10-25 Redelstecker 2-pol.	High Flex Leder	7T4SH087512754A05
ABITIG® 200F	4 m	ED	BSB 10-25 Redelstecker 2-pol.	Standard	7T4FK047512754A05
	8 m	ED	BSB 10-25 Redelstecker 2-pol.	Standard	7T4FK087512754A05
	4 m	ED	BSB 10-25 Redelstecker 2-pol.	High Flex Leder	7T4FH047512754A05
	8 m	ED	BSB 10-25 Redelstecker 2-pol.	High Flex Leder	7T4FH087512754A05
ABITIG® 150	4 m	ED	BSB 10-25 Redelstecker 2-pol.	Standard	7T6SK047512754A05
	8 m	ED	BSB 10-25 Redelstecker 2-pol.	Standard	7T6SK087512754A05
	4 m	ED	BSB 10-25 Redelstecker 2-pol.	High Flex Leder	7T6SH047512754A05
	8 m	ED	BSB 10-25 Redelstecker 2-pol.	High Flex Leder	7T6SH087512754A05
ABITIG® 150 Little	4 m	ED	BSB 10-25 Redelstecker 2-pol.	High Flex Leder	7L6SH047512754A05
	8 m	ED	BSB 10-25 Redelstecker 2-pol.	High Flex Leder	7L6SH087512754A05
ABITIG® 150F	4 m	ED	BSB 10-25 Redelstecker 2-pol.	Standard	7T6FK047512754A05
	8 m	ED	BSB 10-25 Redelstecker 2-pol.	Standard	7T6FK087512754A05
	4 m	ED	BSB 10-25 Redelstecker 2-pol.	High Flex Leder	7T6FH047512754A05
	8 m	ED	BSB 10-25 Redelstecker 2-pol.	High Flex Leder	7T6FH087512754A05
ABITIG® 150F Little	4 m	ED	BSB 10-25 Redelstecker 2-pol.	High Flex Leder	7L6FH047512754A05
	8 m	ED	BSB 10-25 Redelstecker 2-pol.	High Flex Leder	7L6FH087512754A05

ABITIG® GRIP / ABITIG® GRIP Little-Brennerpreisliste

passend für WIG-Stromquellen des Fabrikates „esab“



Brennertyp	Länge	Schalterfunktion	maschinenseitiger Anschluss	Schlauchpaketausführung	Bestellnummer
ABITIG® 18	4 m	ED	ZA 9-pol.	Standard	7S4SK047510799B12
	8 m	ED	ZA 9-pol.	Standard	7S4SK087510799B12
	4 m	ED	ZA 9-pol.	High Flex Leder	7S4SH047510799B12
	8 m	ED	ZA 9-pol.	High Flex Leder	7S4SH087510799B12
ABITIG® 18F	4 m	ED	ZA 9-pol.	Standard	7S4FK047510799B12
	8 m	ED	ZA 9-pol.	Standard	7S4FK087510799B12
	4 m	ED	ZA 9-pol.	High Flex Leder	7S4FH047510799B12
	8 m	ED	ZA 9-pol.	High Flex Leder	7S4FH087510799B12
ABITIG® 20	4 m	ED	ZA 9-pol.	Standard	7S5SK047510799B12
	8 m	ED	ZA 9-pol.	Standard	7S5SK087510799B12
	4 m	ED	ZA 9-pol.	High Flex Leder	7S5SH047510799B12
	8 m	ED	ZA 9-pol.	High Flex Leder	7S5SH087510799B12
ABITIG® 20 Little	4 m	ED	ZA 9-pol.	High Flex Leder	7L5SH047510799B12
	8 m	ED	ZA 9-pol.	High Flex Leder	7L5SH087510799B12
ABITIG® 20F	4 m	ED	ZA 9-pol.	Standard	7S5FK047510799B12
	8 m	ED	ZA 9-pol.	Standard	7S5FK087510799B12
	4 m	ED	ZA 9-pol.	High Flex Leder	7S5FH047510799B12
	8 m	ED	ZA 9-pol.	High Flex Leder	7S5FH087510799B12
ABITIG® 20F Little	4 m	ED	ZA 9-pol.	High Flex Leder	7L5FH047510799B12
	8 m	ED	ZA 9-pol.	High Flex Leder	7L5FH087510799B12

Technische Änderungen vorbehalten • Verkaufspreise = unverbindliche Preisempfehlung - Angebot freibleibend • © Copyright

ABITIG® GRIP / ABITIG® GRIP Little-Brennerpreisliste

passend für WIG-Stromquellen des Fabrikates „esab“

Brennertyp	Länge	Schalterfunktion	maschinenseitiger Anschluss	Schlauchpaketausführung	Bestellnummer
ABITIG® 12-1	4 m	ED	ZA 9-pol.	Standard	7S6SK047510799B12
	8 m	ED	ZA 9-pol.	Standard	7S6SK087510799B12
	4 m	ED	ZA 9-pol.	High Flex Leder	7S6SH047510799B12
	8 m	ED	ZA 9-pol.	High Flex Leder	7S6SH087510799B12
ABITIG® 18SC	4 m	ED	ZA 9-pol.	Standard	7S7SK047510799B12
	8 m	ED	ZA 9-pol.	Standard	7S7SK087510799B12
	4 m	ED	ZA 9-pol.	High Flex Leder	7S7SH047510799B12
	8 m	ED	ZA 9-pol.	High Flex Leder	7S7SH087510799B12
ABITIG® 24W	4 m	ED	ZA 9-pol.	Standard	7S9SK047510799B12
	8 m	ED	ZA 9-pol.	Standard	7S9SK087510799B12
	4 m	ED	ZA 9-pol.	High Flex Leder	7S9SH047510799B12
	8 m	ED	ZA 9-pol.	High Flex Leder	7S9SH087510799B12
ABITIG® 24W Little	4 m	ED	ZA 9-pol.	High Flex Leder	7L9SH047510799B12
	8 m	ED	ZA 9-pol.	High Flex Leder	7L9SH087510799B12
ABITIG® 450W	4 m	ED	ZA 9-pol.	Standard	7T5SK047510799B12
	8 m	ED	ZA 9-pol.	Standard	7T5SK087510799B12
	4 m	ED	ZA 9-pol.	High Flex Leder	7T5SH047510799B12
	8 m	ED	ZA 9-pol.	High Flex Leder	7T5SH087510799B12
ABITIG® 260W	4 m	ED	ZA 9-pol.	Standard	7T7SK047510799B12
	8 m	ED	ZA 9-pol.	Standard	7T7SK087510799B12
	4 m	ED	ZA 9-pol.	High Flex Leder	7T7SH047510799B12
	8 m	ED	ZA 9-pol.	High Flex Leder	7T7SH087510799B12
ABITIG® 260W Little	4 m	ED	ZA 9-pol.	High Flex Leder	7L7SH047510799B12
	8 m	ED	ZA 9-pol.	High Flex Leder	7L7SH087510799B12
ABITIG® 450W SC	4 m	ED	ZA 9-pol.	Standard	
	8 m	ED	ZA 9-pol.	Standard	
	4 m	ED	ZA 9-pol.	High Flex Leder	7T8SH047510799B12
	8 m	ED	ZA 9-pol.	High Flex Leder	7T8SH087510799B12

ABITIG® GRIP / ABITIG® GRIP Little-Brennerpreisliste

passend für WIG-Stromquellen des Fabrikates „esab“

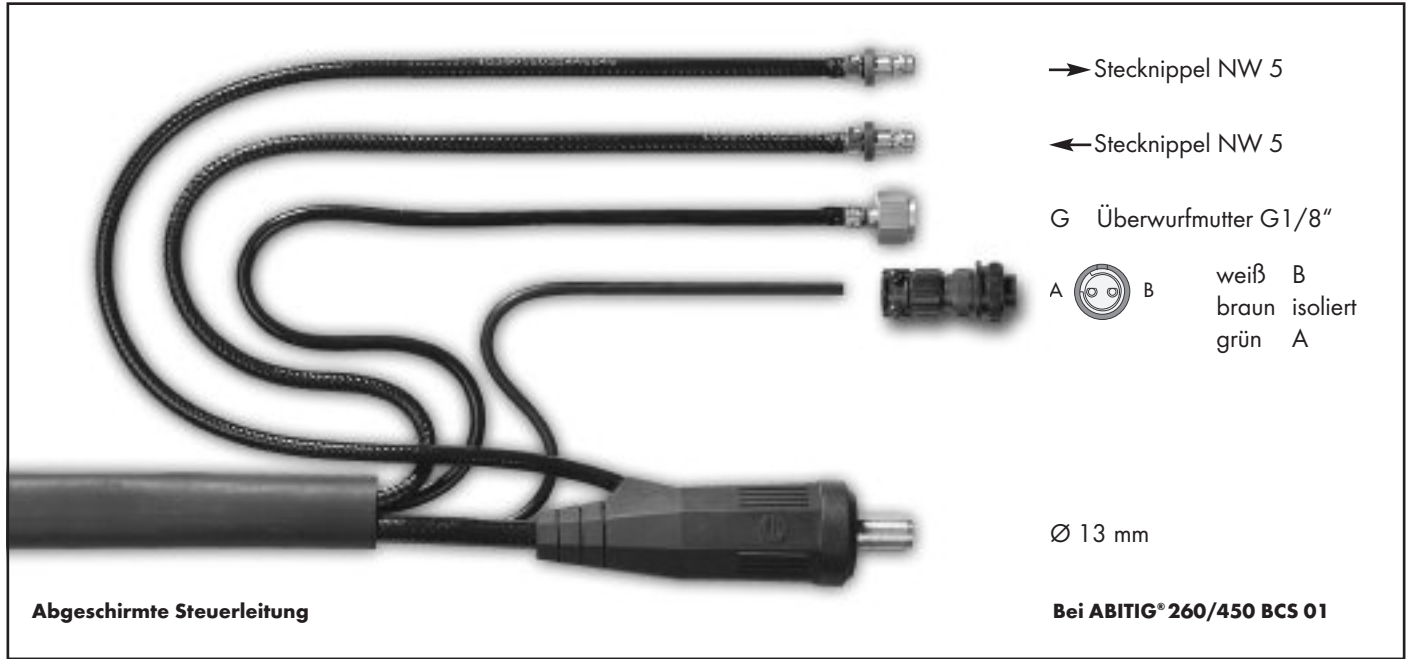

Brennertyp	Länge	Schalterfunktion	maschinenseitiger Anschluss	Schlauchpaketausführung	Bestellnummer
ABITIG® 18	4 m	ED	BSB 35-50 Amphenol 2-pol.	Standard	7S4SK047510009A21
	8 m	ED	BSB 35-50 Amphenol 2-pol.	Standard	7S4SK087510009A21
	4 m	ED	BSB 35-50 Amphenol 2-pol.	High Flex Leder	7S4SH047510009A21
	8 m	ED	BSB 35-50 Amphenol 2-pol.	High Flex Leder	7S4SH087510009A21
ABITIG® 18F	4 m	ED	BSB 35-50 Amphenol 2-pol.	Standard	7S4FK047510009A21
	8 m	ED	BSB 35-50 Amphenol 2-pol.	Standard	7S4FK087510009A21
	4 m	ED	BSB 35-50 Amphenol 2-pol.	High Flex Leder	7S4FH047510009A21
	8 m	ED	BSB 35-50 Amphenol 2-pol.	High Flex Leder	7S4FH087510009A21
ABITIG® 20	4 m	ED	BSB 35-50 Amphenol 2-pol.	Standard	7S5SK047510009A21
	8 m	ED	BSB 35-50 Amphenol 2-pol.	Standard	7S5SK087510009A21
	4 m	ED	BSB 35-50 Amphenol 2-pol.	High Flex Leder	7S5SH047510009A21
	8 m	ED	BSB 35-50 Amphenol 2-pol.	High Flex Leder	7S5SH087510009A21
ABITIG® 20 Little	4 m	ED	BSB 35-50 Amphenol 2-pol.	High Flex Leder	7L5SH047510009A21
	8 m	ED	BSB 35-50 Amphenol 2-pol.	High Flex Leder	7L5SH087510009A21
ABITIG® 20F	4 m	ED	BSB 35-50 Amphenol 2-pol.	Standard	7S5FK047510009A21
	8 m	ED	BSB 35-50 Amphenol 2-pol.	Standard	7S5FK087510009A21
	4 m	ED	BSB 35-50 Amphenol 2-pol.	High Flex Leder	7S5FH047510009A21
	8 m	ED	BSB 35-50 Amphenol 2-pol.	High Flex Leder	7S5FH087510009A21
ABITIG® 20F Little	4 m	ED	BSB 35-50 Amphenol 2-pol.	High Flex Leder	7L5FH047510009A21
	8 m	ED	BSB 35-50 Amphenol 2-pol.	High Flex Leder	7L5FH087510009A21

Technische Änderungen vorbehalten • Verkaufspreise = unverbindliche Preisempfehlung - Angebot freibleibend • © Copyright

ABITIG® GRIP / ABITIG® GRIP Little-Brennerpreisliste

passend für WIG-Stromquellen des Fabrikates „esab“

Brennertyp	Länge	Schalterfunktion	maschinenseitiger Anschluss	Schlauchpaketausführung	Bestellnummer
ABITIG® 12-1	4 m	ED	BSB 35-50 Amphenol 2-pol.	Standard	7S6SK047510009A21
	8 m	ED	BSB 35-50 Amphenol 2-pol.	Standard	7S6SK087510009A21
	4 m	ED	BSB 35-50 Amphenol 2-pol.	High Flex Leder	7S6SH047510009A21
	8 m	ED	BSB 35-50 Amphenol 2-pol.	High Flex Leder	7S6SH087510009A21
ABITIG® 18SC	4 m	ED	BSB 35-50 Amphenol 2-pol.	Standard	7S7SK047510009A21
	8 m	ED	BSB 35-50 Amphenol 2-pol.	Standard	7S7SK087510009A21
	4 m	ED	BSB 35-50 Amphenol 2-pol.	High Flex Leder	7S7SH047510009A21
	8 m	ED	BSB 35-50 Amphenol 2-pol.	High Flex Leder	7S7SH087510009A21
ABITIG® 24W	4 m	ED	BSB 35-50 Amphenol 2-pol.	Standard	7S9SK047510009A21
	8 m	ED	BSB 35-50 Amphenol 2-pol.	Standard	7S9SK087510009A21
	4 m	ED	BSB 35-50 Amphenol 2-pol.	High Flex Leder	7S9SH047510009A21
	8 m	ED	BSB 35-50 Amphenol 2-pol.	High Flex Leder	7S9SH087510009A21
ABITIG® 24W Little	4 m	ED	BSB 35-50 Amphenol 2-pol.	High Flex Leder	7L9SH047510009A21
	8 m	ED	BSB 35-50 Amphenol 2-pol.	High Flex Leder	7L9SH087510009A21
ABITIG® 450W	4 m	ED	BSB 35-50 Amphenol 2-pol.	Standard	7T5SK047510109A21
	8 m	ED	BSB 35-50 Amphenol 2-pol.	Standard	7T5SK087510109A21
	4 m	ED	BSB 35-50 Amphenol 2-pol.	High Flex Leder	7T5SH047510109A21
	8 m	ED	BSB 35-50 Amphenol 2-pol.	High Flex Leder	7T5SH087510109A21
ABITIG® 260W	4 m	ED	BSB 35-50 Amphenol 2-pol.	Standard	7T7SK047510109A21
	8 m	ED	BSB 35-50 Amphenol 2-pol.	Standard	7T7SK087510109A21
	4 m	ED	BSB 35-50 Amphenol 2-pol.	High Flex Leder	7T7SH047510109A21
	8 m	ED	BSB 35-50 Amphenol 2-pol.	High Flex Leder	7T7SH087510109A21
ABITIG® 260W Little	4 m	ED	BSB 35-50 Amphenol 2-pol.	High Flex Leder	7L7SH047510109A21
	8 m	ED	BSB 35-50 Amphenol 2-pol.	High Flex Leder	7L7SH087510109A21
ABITIG® 450W SC	4 m	ED	BSB 35-50 Amphenol 2-pol.	Standard	
	8 m	ED	BSB 35-50 Amphenol 2-pol.	Standard	
	4 m	ED	BSB 35-50 Amphenol 2-pol.	High Flex Leder	7T8SH047510109A21
	8 m	ED	BSB 35-50 Amphenol 2-pol.	High Flex Leder	7T8SH087510109A21

ABITIG® GRIP / ABITIG® GRIP Little-Brennerpreisliste

passend für WIG-Stromquellen des Fabrikates „esab“

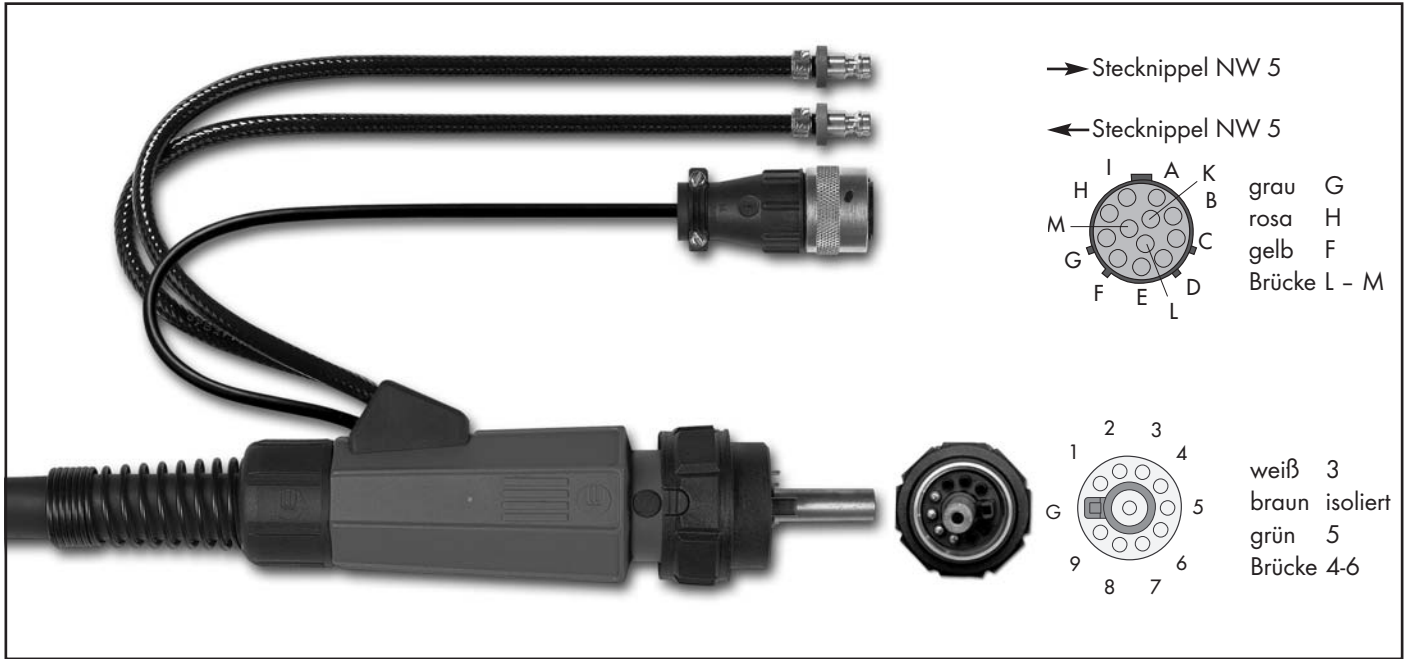

Brennertyp	Länge	Schalterfunktion	maschinenseitiger Anschluss	Schlauchpaketausführung	Bestellnummer
ABITIG® 18	4 m	EDP	ZA 9-pol./Burndy 12-pol.	Standard	7S4SK047540739B12
	8 m	EDP	ZA 9-pol./Burndy 12-pol.	Standard	7S4SK087540739B12
	4 m	EDP	ZA 9-pol./Burndy 12-pol.	High Flex Leder	7S4SH047540739B12
	8 m	EDP	ZA 9-pol./Burndy 12-pol.	High Flex Leder	7S4SH087540739B12
ABITIG® 18F	4 m	EDP	ZA 9-pol./Burndy 12-pol.	Standard	7S4FK047540739B12
	8 m	EDP	ZA 9-pol./Burndy 12-pol.	Standard	7S4FK087540739B12
	4 m	EDP	ZA 9-pol./Burndy 12-pol.	High Flex Leder	7S4FH047540739B12
	8 m	EDP	ZA 9-pol./Burndy 12-pol.	High Flex Leder	7S4FH087540739B12
ABITIG® 20	4 m	EDP	ZA 9-pol./Burndy 12-pol.	Standard	7S5SK047540739B12
	8 m	EDP	ZA 9-pol./Burndy 12-pol.	Standard	7S5SK087540739B12
	4 m	EDP	ZA 9-pol./Burndy 12-pol.	High Flex Leder	7S5SH047540739B12
	8 m	EDP	ZA 9-pol./Burndy 12-pol.	High Flex Leder	7S5SH087540739B12
ABITIG® 20F	4 m	EDP	ZA 9-pol./Burndy 12-pol.	Standard	7S5FK047540739B12
	8 m	EDP	ZA 9-pol./Burndy 12-pol.	Standard	7S5FK087540739B12
	4 m	EDP	ZA 9-pol./Burndy 12-pol.	High Flex Leder	7S5FH047540739B12
	8 m	EDP	ZA 9-pol./Burndy 12-pol.	High Flex Leder	7S5FH087540739B12

Technische Änderungen vorbehalten • Verkaufspreise = unverbindliche Preisempfehlung - Angebot freibleibend • © Copyright

ABITIG® GRIP / ABITIG® GRIP Little-Brennerpreisliste

passend für WIG-Stromquellen des Fabrikates „esab“

Brennertyp	Länge	Schalterfunktion	maschinenseitiger Anschluss	Schlauchpaketausführung	Bestellnummer
ABITIG® 12-1	4 m	EDP	ZA 9-pol./Burndy 12-pol.	Standard	7S6SK047540739B12
	8 m	EDP	ZA 9-pol./Burndy 12-pol.	Standard	7S6SK087540739B12
	4 m	EDP	ZA 9-pol./Burndy 12-pol.	High Flex Leder	7S6SH047540739B12
	8 m	EDP	ZA 9-pol./Burndy 12-pol.	High Flex Leder	7S6SH087540739B12

ABITIG® 18SC	4 m	EDP	ZA 9-pol./Burndy 12-pol.	Standard	7S7SK047540739B12
	8 m	EDP	ZA 9-pol./Burndy 12-pol.	Standard	7S7SK087540739B12
	4 m	EDP	ZA 9-pol./Burndy 12-pol.	High Flex Leder	7S7SH047540739B12
	8 m	EDP	ZA 9-pol./Burndy 12-pol.	High Flex Leder	7S7SH087540739B12

ABITIG® 24W	4 m	EDP	ZA 9-pol./Burndy 12-pol.	Standard	7S9SK047540739B12
	8 m	EDP	ZA 9-pol./Burndy 12-pol.	Standard	7S9SK087540739B12
	4 m	EDP	ZA 9-pol./Burndy 12-pol.	High Flex Leder	7S9SH047540739B12
	8 m	EDP	ZA 9-pol./Burndy 12-pol.	High Flex Leder	7S9SH087540739B12

ABITIG® 450W	4 m	EDP	ZA 9-pol./Burndy 12-pol.	Standard	7T5SK047540739B12
	8 m	EDP	ZA 9-pol./Burndy 12-pol.	Standard	7T5SK087540739B12
	4 m	EDP	ZA 9-pol./Burndy 12-pol.	High Flex Leder	7T5SH047540739B12
	8 m	EDP	ZA 9-pol./Burndy 12-pol.	High Flex Leder	7T5SH087540739B12

ABITIG® 260W	4 m	EDP	ZA 9-pol./Burndy 12-pol.	Standard	7T7SK047540739B12
	8 m	EDP	ZA 9-pol./Burndy 12-pol.	Standard	7T7SK087540739B12
	4 m	EDP	ZA 9-pol./Burndy 12-pol.	High Flex Leder	7T7SH047540739B12
	8 m	EDP	ZA 9-pol./Burndy 12-pol.	High Flex Leder	7T7SH087540739B12

ABITIG® 450W SC	4 m	EDP	ZA 9-pol./Burndy 12-pol.	Standard	
	8 m	EDP	ZA 9-pol./Burndy 12-pol.	Standard	
	4 m	EDP	ZA 9-pol./Burndy 12-pol.	High Flex Leder	7T8SH047540739B12
	8 m	EDP	ZA 9-pol./Burndy 12-pol.	High Flex Leder	7T8SH087540739B12

ABITIG® GRIP / ABITIG® GRIP Little-Brennerpreisliste

passend für WIG-Stromquellen des Fabrikates „ess“

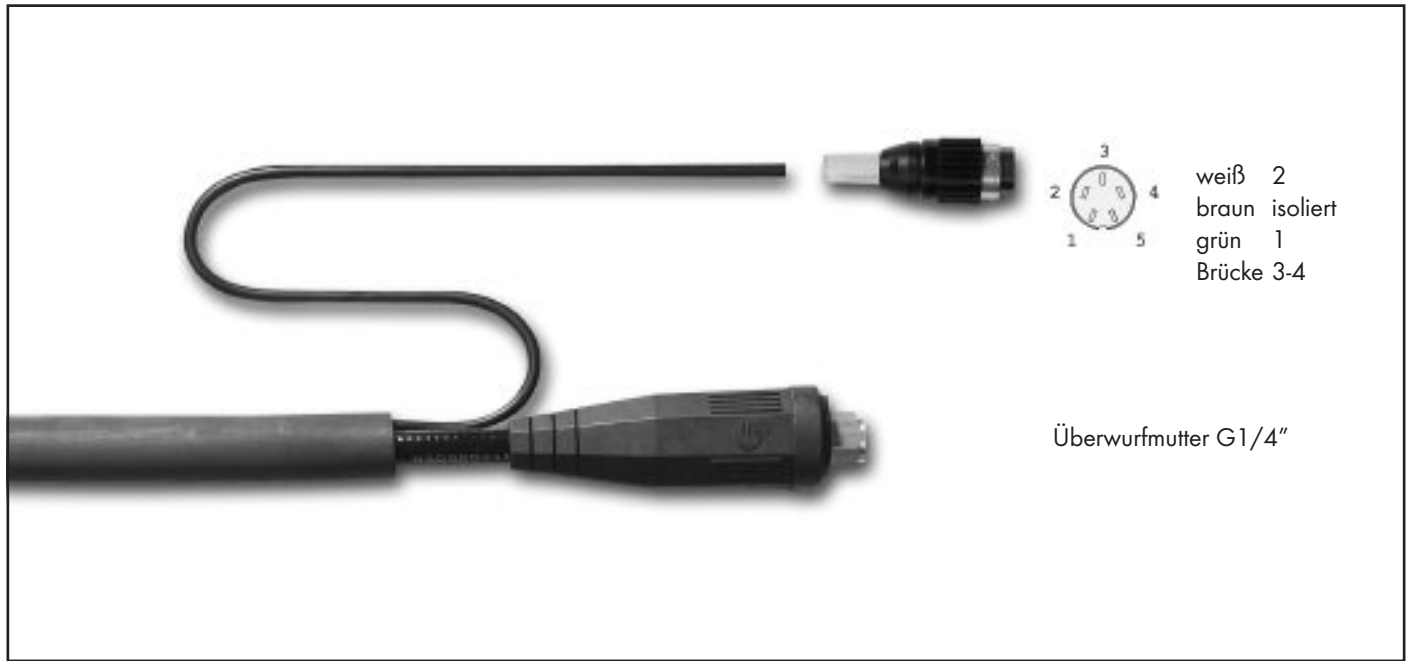

Brennertyp	Länge	Schalterfunktion	maschinenseitiger Anschluss	Schlauchpaketausführung	Bestellnummer
ABITIG® 9	4 m	ED	EA Tuchel 5-pol.	Standard	7S1SK043511106A00
	8 m	ED	EA Tuchel 5-pol.	Standard	7S1SK083511106A00
	4 m	ED	EA Tuchel 5-pol.	High Flex Leder	7S1SH043511106A00
	8 m	ED	EA Tuchel 5-pol.	High Flex Leder	7S1SH083511106A00
ABITIG® 9 Little	4 m	ED	EA Tuchel 5-pol.	High Flex Leder	7L1SH043511106A00
	8 m	ED	EA Tuchel 5-pol.	High Flex Leder	7L1SH083511106A00
ABITIG® 9F	4 m	ED	EA Tuchel 5-pol.	Standard	7S1FK043511106A00
	8 m	ED	EA Tuchel 5-pol.	Standard	7S1FK083511106A00
	4 m	ED	EA Tuchel 5-pol.	High Flex Leder	7S1FH043511106A00
	8 m	ED	EA Tuchel 5-pol.	High Flex Leder	7S1FH083511106A00
ABITIG® 9F Little	4 m	ED	EA Tuchel 5-pol.	High Flex Leder	7L1FH043511106A00
	8 m	ED	EA Tuchel 5-pol.	High Flex Leder	7L1FH083511106A00
ABITIG® 17	4 m	ED	EA Tuchel 5-pol.	Standard	7S2SK043511106A00
	8 m	ED	EA Tuchel 5-pol.	Standard	7S2SK083511106A00
	4 m	ED	EA Tuchel 5-pol.	High Flex Leder	7S2SH043511106A00
	8 m	ED	EA Tuchel 5-pol.	High Flex Leder	7S2SH083511106A00
ABITIG® 17 Little	4 m	ED	EA Tuchel 5-pol.	High Flex Leder	7L2SH043511106A00
	8 m	ED	EA Tuchel 5-pol.	High Flex Leder	7L2SH083511106A00
ABITIG® 17F	4 m	ED	EA Tuchel 5-pol.	Standard	7S2FK043511106A00
	8 m	ED	EA Tuchel 5-pol.	Standard	7S2FK083511106A00
	4 m	ED	EA Tuchel 5-pol.	High Flex Leder	7S2FH043511106A00
	8 m	ED	EA Tuchel 5-pol.	High Flex Leder	7S2FH083511106A00
ABITIG® 17F Little	4 m	ED	EA Tuchel 5-pol.	High Flex Leder	7L2FH043511106A00
	8 m	ED	EA Tuchel 5-pol.	High Flex Leder	7L2FH083511106A00

Technische Änderungen vorbehalten • Verkaufspreise = unverbindliche Preisempfehlung - Angebot freibleibend • © Copyright

ABITIG® GRIP / ABITIG® GRIP Little-Brennerpreisliste

passend für WIG-Stromquellen des Fabrikates „ess“

Brennertyp	Länge	Schalterfunktion	maschinenseitiger Anschluss	Schlauchpaketausführung	Bestellnummer
ABITIG® 26	4 m	ED	EA Tuchel 5-pol.	Standard	7S3SK043511106A00
	8 m	ED	EA Tuchel 5-pol.	Standard	7S3SK083511106A00
	4 m	ED	EA Tuchel 5-pol.	High Flex Leder	7S3SH043511106A00
	8 m	ED	EA Tuchel 5-pol.	High Flex Leder	7S3SH083511106A00
ABITIG® 26F	4 m	ED	EA Tuchel 5-pol.	Standard	7S3FK043511106A00
	8 m	ED	EA Tuchel 5-pol.	Standard	7S3FK083511106A00
	4 m	ED	EA Tuchel 5-pol.	High Flex Leder	7S3FH043511106A00
	8 m	ED	EA Tuchel 5-pol.	High Flex Leder	7S3FH083511106A00
ABITIG® 24G	4 m	ED	EA Tuchel 5-pol.	Standard	7S8SK043511106A00
	8 m	ED	EA Tuchel 5-pol.	Standard	7S8SK083511106A00
	4 m	ED	EA Tuchel 5-pol.	High Flex Leder	7S8SH043511106A00
	8 m	ED	EA Tuchel 5-pol.	High Flex Leder	7S8SH083511106A00
ABITIG® 24G Little	4 m	ED	EA Tuchel 5-pol.	High Flex Leder	7L8SH043511106A00
	8 m	ED	EA Tuchel 5-pol.	High Flex Leder	7L8SH083511106A00
ABITIG® 200	4 m	ED	EA Tuchel 5-pol.	Standard	7T4SK043511106A00
	8 m	ED	EA Tuchel 5-pol.	Standard	7T4SK083511106A00
	4 m	ED	EA Tuchel 5-pol.	High Flex Leder	7T4SH043511106A00
	8 m	ED	EA Tuchel 5-pol.	High Flex Leder	7T4SH083511106A00
ABITIG® 200F	4 m	ED	EA Tuchel 5-pol.	Standard	7T4FK043511106A00
	8 m	ED	EA Tuchel 5-pol.	Standard	7T4FK083511106A00
	4 m	ED	EA Tuchel 5-pol.	High Flex Leder	7T4FH043511106A00
	8 m	ED	EA Tuchel 5-pol.	High Flex Leder	7T4FH083511106A00
ABITIG® 150	4 m	ED	EA Tuchel 5-pol.	Standard	7T6SK043511106A00
	8 m	ED	EA Tuchel 5-pol.	Standard	7T6SK083511106A00
	4 m	ED	EA Tuchel 5-pol.	High Flex Leder	7T6SH043511106A00
	8 m	ED	EA Tuchel 5-pol.	High Flex Leder	7T6SH083511106A00
ABITIG® 150 Little	4 m	ED	EA Tuchel 5-pol.	High Flex Leder	7L6SH043511106A00
	8 m	ED	EA Tuchel 5-pol.	High Flex Leder	7L6SH083511106A00
ABITIG® 150F	4 m	ED	EA Tuchel 5-pol.	Standard	7T6FK043511106A00
	8 m	ED	EA Tuchel 5-pol.	Standard	7T6FK083511106A00
	4 m	ED	EA Tuchel 5-pol.	High Flex Leder	7T6FH043511106A00
	8 m	ED	EA Tuchel 5-pol.	High Flex Leder	7T6FH083511106A00
ABITIG® 150F Little	4 m	ED	EA Tuchel 5-pol.	High Flex Leder	7L6FH043511106A00
	8 m	ED	EA Tuchel 5-pol.	High Flex Leder	7L6FH083511106A00

ABITIG® GRIP / ABITIG® GRIP Little-Brennerpreisliste

passend für WIG-Stromquellen des Fabrikates „ess“



Brennertyp	Länge	Schalterfunktion	maschinenseitiger Anschluss	Schlauchpaketausführung	Bestellnummer
ABITIG® 9	4 m	ED	BSB 35-50 Tuchel 5-pol.	Standard	7S1SK043510006A01
	8 m	ED	BSB 35-50 Tuchel 5-pol.	Standard	7S1SK083510006A01
	4 m	ED	BSB 35-50 Tuchel 5-pol.	High Flex Leder	7S1SH043510006A01
	8 m	ED	BSB 35-50 Tuchel 5-pol.	High Flex Leder	7S1SH083510006A01
ABITIG® 9 Little	4 m	ED	BSB 35-50 Tuchel 5-pol.	High Flex Leder	7L1SH043510006A01
	8 m	ED	BSB 35-50 Tuchel 5-pol.	High Flex Leder	7L1SH083510006A01
ABITIG® 9F	4 m	ED	BSB 35-50 Tuchel 5-pol.	Standard	7S1FK043510006A01
	8 m	ED	BSB 35-50 Tuchel 5-pol.	Standard	7S1FK083510006A01
	4 m	ED	BSB 35-50 Tuchel 5-pol.	High Flex Leder	7S1FH043510006A01
	8 m	ED	BSB 35-50 Tuchel 5-pol.	High Flex Leder	7S1FH083510006A01
ABITIG® 9F Little	4 m	ED	BSB 35-50 Tuchel 5-pol.	High Flex Leder	7L1FH043510006A01
	8 m	ED	BSB 35-50 Tuchel 5-pol.	High Flex Leder	7L1FH083510006A01
ABITIG® 17	4 m	ED	BSB 35-50 Tuchel 5-pol.	Standard	7S2SK043510006A01
	8 m	ED	BSB 35-50 Tuchel 5-pol.	Standard	7S2SK083510006A01
	4 m	ED	BSB 35-50 Tuchel 5-pol.	High Flex Leder	7S2SH043510006A01
	8 m	ED	BSB 35-50 Tuchel 5-pol.	High Flex Leder	7S2SH083510006A01
ABITIG® 17 Little	4 m	ED	BSB 35-50 Tuchel 5-pol.	High Flex Leder	7L2SH043510006A01
	8 m	ED	BSB 35-50 Tuchel 5-pol.	High Flex Leder	7L2SH083510006A01
ABITIG® 17F	4 m	ED	BSB 35-50 Tuchel 5-pol.	Standard	7S2FK043510006A01
	8 m	ED	BSB 35-50 Tuchel 5-pol.	Standard	7S2FK083510006A01
	4 m	ED	BSB 35-50 Tuchel 5-pol.	High Flex Leder	7S2FH043510006A01
	8 m	ED	BSB 35-50 Tuchel 5-pol.	High Flex Leder	7S2FH083510006A01
ABITIG® 17F Little	4 m	ED	BSB 35-50 Tuchel 5-pol.	High Flex Leder	7L2FH043510006A01
	8 m	ED	BSB 35-50 Tuchel 5-pol.	High Flex Leder	7L2FH083510006A01

Technische Änderungen vorbehalten • Verkaufspreise = unverbindliche Preisempfehlung - Angebot freibleibend • © Copyright

ABITIG® GRIP / ABITIG® GRIP Little-Brennerpreisliste

passend für WIG-Stromquellen des Fabrikates „ess“

Brennertyp	Länge	Schalterfunktion	maschinenseitiger Anschluss	Schlauchpaketausführung	Bestellnummer
ABITIG® 26	4 m	ED	BSB 35-50 Tuchel 5-pol.	Standard	7S3SK043510006A01
	8 m	ED	BSB 35-50 Tuchel 5-pol.	Standard	7S3SK083510006A01
	4 m	ED	BSB 35-50 Tuchel 5-pol.	High Flex Leder	7S3SH043510006A01
	8 m	ED	BSB 35-50 Tuchel 5-pol.	High Flex Leder	7S3SH083510006A01
ABITIG® 26F	4 m	ED	BSB 35-50 Tuchel 5-pol.	Standard	7S3FK043510006A01
	8 m	ED	BSB 35-50 Tuchel 5-pol.	Standard	7S3FK083510006A01
	4 m	ED	BSB 35-50 Tuchel 5-pol.	High Flex Leder	7S3FH043510006A01
	8 m	ED	BSB 35-50 Tuchel 5-pol.	High Flex Leder	7S3FH083510006A01
ABITIG® 24G	4 m	ED	BSB 35-50 Tuchel 5-pol.	Standard	7S8SK043510006A01
	8 m	ED	BSB 35-50 Tuchel 5-pol.	Standard	7S8SK083510006A01
	4 m	ED	BSB 35-50 Tuchel 5-pol.	High Flex Leder	7S8SH043510006A01
	8 m	ED	BSB 35-50 Tuchel 5-pol.	High Flex Leder	7S8SH083510006A01
ABITIG® 24G Little	4 m	ED	BSB 35-50 Tuchel 5-pol.	High Flex Leder	7L8SH043510006A01
	8 m	ED	BSB 35-50 Tuchel 5-pol.	High Flex Leder	7L8SH083510006A01
ABITIG® 200	4 m	ED	BSB 35-50 Tuchel 5-pol.	Standard	7T4SK043510006A01
	8 m	ED	BSB 35-50 Tuchel 5-pol.	Standard	7T4SK083510006A01
	4 m	ED	BSB 35-50 Tuchel 5-pol.	High Flex Leder	7T4SH043510006A01
	8 m	ED	BSB 35-50 Tuchel 5-pol.	High Flex Leder	7T4SH083510006A01
ABITIG® 200F	4 m	ED	BSB 35-50 Tuchel 5-pol.	Standard	7T4FK043510006A01
	8 m	ED	BSB 35-50 Tuchel 5-pol.	Standard	7T4FK083510006A01
	4 m	ED	BSB 35-50 Tuchel 5-pol.	High Flex Leder	7T4FH043510006A01
	8 m	ED	BSB 35-50 Tuchel 5-pol.	High Flex Leder	7T4FH083510006A01
ABITIG® 150	4 m	ED	BSB 35-50 Tuchel 5-pol.	Standard	7T6SK043510006A01
	8 m	ED	BSB 35-50 Tuchel 5-pol.	Standard	7T6SK083510006A01
	4 m	ED	BSB 35-50 Tuchel 5-pol.	High Flex Leder	7T6SH043510006A01
	8 m	ED	BSB 35-50 Tuchel 5-pol.	High Flex Leder	7T6SH083510006A01
ABITIG® 150 Little	4 m	ED	BSB 35-50 Tuchel 5-pol.	High Flex Leder	7L6SH043510006A01
	8 m	ED	BSB 35-50 Tuchel 5-pol.	High Flex Leder	7L6SH083510006A01
ABITIG® 150F	4 m	ED	BSB 35-50 Tuchel 5-pol.	Standard	7T6FK043510006A01
	8 m	ED	BSB 35-50 Tuchel 5-pol.	Standard	7T6FK083510006A01
	4 m	ED	BSB 35-50 Tuchel 5-pol.	High Flex Leder	7T6FH043510006A01
	8 m	ED	BSB 35-50 Tuchel 5-pol.	High Flex Leder	7T6FH083510006A01
ABITIG® 150F Little	4 m	ED	BSB 35-50 Tuchel 5-pol.	High Flex Leder	7L6FH043510006A01
	8 m	ED	BSB 35-50 Tuchel 5-pol.	High Flex Leder	7L6FH083510006A01

ABITIG® GRIP / ABITIG® GRIP Little-Brennerpreisliste

passend für WIG-Stromquellen des Fabrikates „ess“

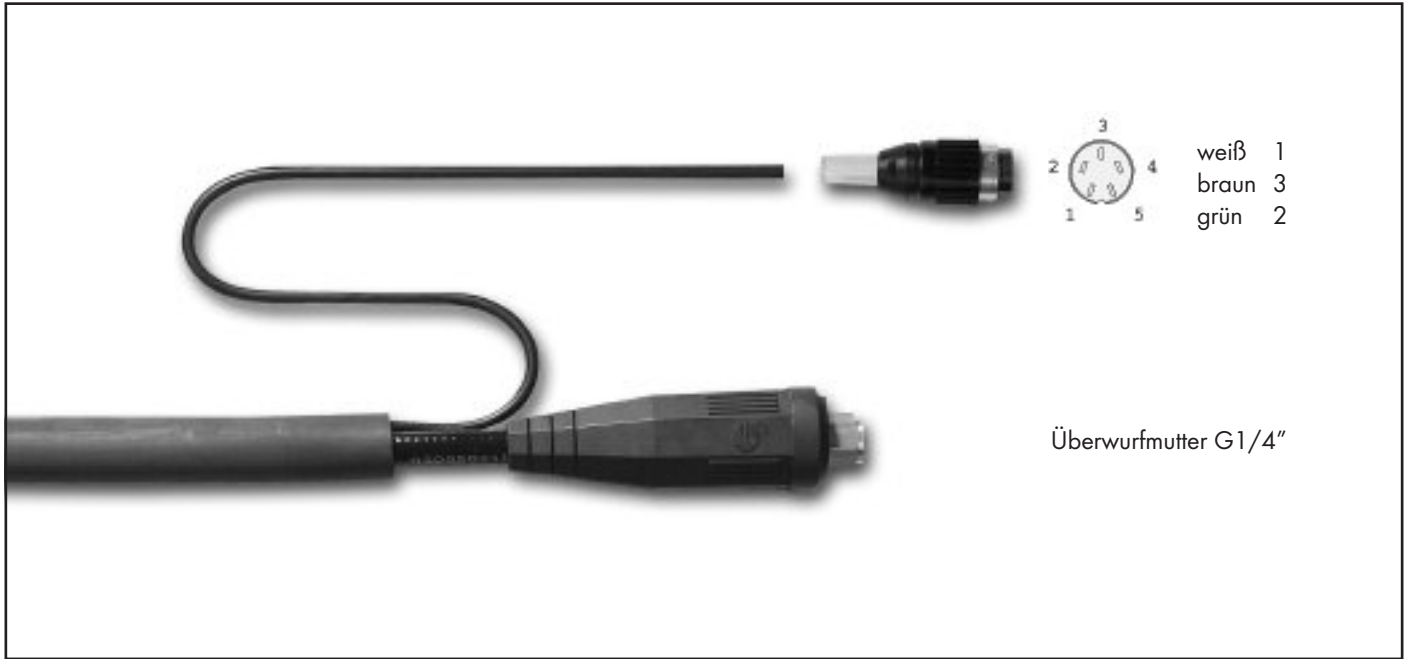

Brennertyp	Länge	Schalterfunktion	maschinenseitiger Anschluss	Schlauchpaketausführung	Bestellnummer
ABITIG® 9	4 m	DD	EA Tuchel 5-pol.	Standard	7S1SK043521101B00
	8 m	DD	EA Tuchel 5-pol.	Standard	7S1SK083521101B00
	4 m	DD	EA Tuchel 5-pol.	High Flex Leder	7S1SH043521101B00
	8 m	DD	EA Tuchel 5-pol.	High Flex Leder	7S1SH083521101B00
ABITIG® 9 Little	4 m	DD	EA Tuchel 5-pol.	High Flex Leder	7L1SH043521101B00
	8 m	DD	EA Tuchel 5-pol.	High Flex Leder	7L1SH083521101B00
ABITIG® 9F	4 m	DD	EA Tuchel 5-pol.	Standard	7S1FK043521101B00
	8 m	DD	EA Tuchel 5-pol.	Standard	7S1FK083521101B00
	4 m	DD	EA Tuchel 5-pol.	High Flex Leder	7S1FH043521101B00
	8 m	DD	EA Tuchel 5-pol.	High Flex Leder	7S1FH083521101B00
ABITIG® 9F Little	4 m	DD	EA Tuchel 5-pol.	High Flex Leder	7L1FH043521101B00
	8 m	DD	EA Tuchel 5-pol.	High Flex Leder	7L1FH083521101B00
ABITIG® 17	4 m	DD	EA Tuchel 5-pol.	Standard	7S2SK043521101B00
	8 m	DD	EA Tuchel 5-pol.	Standard	7S2SK083521101B00
	4 m	DD	EA Tuchel 5-pol.	High Flex Leder	7S2SH043521101B00
	8 m	DD	EA Tuchel 5-pol.	High Flex Leder	7S2SH083521101B00
ABITIG® 17 Little	4 m	DD	EA Tuchel 5-pol.	High Flex Leder	7L2SH043521101B00
	8 m	DD	EA Tuchel 5-pol.	High Flex Leder	7L2SH083521101B00
ABITIG® 17F	4 m	DD	EA Tuchel 5-pol.	Standard	7S2FK043521101B00
	8 m	DD	EA Tuchel 5-pol.	Standard	7S2FK083521101B00
	4 m	DD	EA Tuchel 5-pol.	High Flex Leder	7S2FH043521101B00
	8 m	DD	EA Tuchel 5-pol.	High Flex Leder	7S2FH083521101B00
ABITIG® 17F Little	4 m	DD	EA Tuchel 5-pol.	High Flex Leder	7L2FH043521101B00
	8 m	DD	EA Tuchel 5-pol.	High Flex Leder	7L2FH083521101B00

Technische Änderungen vorbehalten • Verkaufspreise = unverbindliche Preisempfehlung - Angebot freibleibend • © Copyright

ABITIG® GRIP / ABITIG® GRIP Little-Brennerpreisliste

passend für WIG-Stromquellen des Fabrikates „ess“

Brennertyp	Länge	Schalterfunktion	maschinenseitiger Anschluss	Schlauchpaketausführung	Bestellnummer
ABITIG® 26	4 m	DD	EA Tuchel 5-pol.	Standard	7S3SK043521101B00
	8 m	DD	EA Tuchel 5-pol.	Standard	7S3SK083521101B00
	4 m	DD	EA Tuchel 5-pol.	High Flex Leder	7S3SH043521101B00
	8 m	DD	EA Tuchel 5-pol.	High Flex Leder	7S3SH083521101B00
ABITIG® 26F	4 m	DD	EA Tuchel 5-pol.	Standard	7S3FK043521101B00
	8 m	DD	EA Tuchel 5-pol.	Standard	7S3FK083521101B00
	4 m	DD	EA Tuchel 5-pol.	High Flex Leder	7S3FH043521101B00
	8 m	DD	EA Tuchel 5-pol.	High Flex Leder	7S3FH083521101B00
ABITIG® 24G	4 m	DD	EA Tuchel 5-pol.	Standard	7S8SK043521101B00
	8 m	DD	EA Tuchel 5-pol.	Standard	7S8SK083521101B00
	4 m	DD	EA Tuchel 5-pol.	High Flex Leder	7S8SH043521101B00
	8 m	DD	EA Tuchel 5-pol.	High Flex Leder	7S8SH083521101B00
ABITIG® 24G Little	4 m	DD	EA Tuchel 5-pol.	High Flex Leder	7L8SH043521101B00
	8 m	DD	EA Tuchel 5-pol.	High Flex Leder	7L8SH083521101B00
ABITIG® 200	4 m	DD	EA Tuchel 5-pol.	Standard	7T4SK043521101B00
	8 m	DD	EA Tuchel 5-pol.	Standard	7T4SK083521101B00
	4 m	DD	EA Tuchel 5-pol.	High Flex Leder	7T4SH043521101B00
	8 m	DD	EA Tuchel 5-pol.	High Flex Leder	7T4SH083521101B00
ABITIG® 200F	4 m	DD	EA Tuchel 5-pol.	Standard	7T4FK043521101B00
	8 m	DD	EA Tuchel 5-pol.	Standard	7T4FK083521101B00
	4 m	DD	EA Tuchel 5-pol.	High Flex Leder	7T4FH043521101B00
	8 m	DD	EA Tuchel 5-pol.	High Flex Leder	7T4FH083521101B00
ABITIG® 150	4 m	DD	EA Tuchel 5-pol.	Standard	7T6SK043521101B00
	8 m	DD	EA Tuchel 5-pol.	Standard	7T6SK083521101B00
	4 m	DD	EA Tuchel 5-pol.	High Flex Leder	7T6SH043521101B00
	8 m	DD	EA Tuchel 5-pol.	High Flex Leder	7T6SH083521101B00
ABITIG® 150 Little	4 m	DD	EA Tuchel 5-pol.	High Flex Leder	7L6SH043521101B00
	8 m	DD	EA Tuchel 5-pol.	High Flex Leder	7L6SH083521101B00
ABITIG® 150F	4 m	DD	EA Tuchel 5-pol.	Standard	7T6FK043521101B00
	8 m	DD	EA Tuchel 5-pol.	Standard	7T6FK083521101B00
	4 m	DD	EA Tuchel 5-pol.	High Flex Leder	7T6FH043521101B00
	8 m	DD	EA Tuchel 5-pol.	High Flex Leder	7T6FH083521101B00
ABITIG® 150F Little	4 m	DD	EA Tuchel 5-pol.	High Flex Leder	7L6FH043521101B00
	8 m	DD	EA Tuchel 5-pol.	High Flex Leder	7L6FH083521101B00

ABITIG® GRIP / ABITIG® GRIP Little-Brennerpreisliste

passend für WIG-Stromquellen des Fabrikates „ess“



Brennertyp	Länge	Schalterfunktion	maschinenseitiger Anschluss	Schlauchpaketausführung	Bestellnummer
ABITIG® 9	4 m	DD	BSB 35-50 Tuchel 5-pol.	Standard	7S1SK043520001B01
	8 m	DD	BSB 35-50 Tuchel 5-pol.	Standard	7S1SK083520001B01
	4 m	DD	BSB 35-50 Tuchel 5-pol.	High Flex Leder	7S1SH043520001B01
	8 m	DD	BSB 35-50 Tuchel 5-pol.	High Flex Leder	7S1SH083520001B01
ABITIG® 9 Little	4 m	DD	BSB 35-50 Tuchel 5-pol.	High Flex Leder	7L1SH043520001B01
	8 m	DD	BSB 35-50 Tuchel 5-pol.	High Flex Leder	7L1SH083520001B01
ABITIG® 9F	4 m	DD	BSB 35-50 Tuchel 5-pol.	Standard	7S1FK043520001B01
	8 m	DD	BSB 35-50 Tuchel 5-pol.	Standard	7S1FK083520001B01
	4 m	DD	BSB 35-50 Tuchel 5-pol.	High Flex Leder	7S1FH043520001B01
	8 m	DD	BSB 35-50 Tuchel 5-pol.	High Flex Leder	7S1FH083520001B01
ABITIG® 9F Little	4 m	DD	BSB 35-50 Tuchel 5-pol.	High Flex Leder	7L1FH043520001B01
	8 m	DD	BSB 35-50 Tuchel 5-pol.	High Flex Leder	7L1FH083520001B01
ABITIG® 17	4 m	DD	BSB 35-50 Tuchel 5-pol.	Standard	7S2SK043520001B01
	8 m	DD	BSB 35-50 Tuchel 5-pol.	Standard	7S2SK083520001B01
	4 m	DD	BSB 35-50 Tuchel 5-pol.	High Flex Leder	7S2SH043520001B01
	8 m	DD	BSB 35-50 Tuchel 5-pol.	High Flex Leder	7S2SH083520001B01
ABITIG® 17 Little	4 m	DD	BSB 35-50 Tuchel 5-pol.	High Flex Leder	7L2SH043520001B01
	8 m	DD	BSB 35-50 Tuchel 5-pol.	High Flex Leder	7L2SH083520001B01
ABITIG® 17F	4 m	DD	BSB 35-50 Tuchel 5-pol.	Standard	7S2FK043520001B01
	8 m	DD	BSB 35-50 Tuchel 5-pol.	Standard	7S2FK083520001B01
	4 m	DD	BSB 35-50 Tuchel 5-pol.	High Flex Leder	7S2FH043520001B01
	8 m	DD	BSB 35-50 Tuchel 5-pol.	High Flex Leder	7S2FH083520001B01
ABITIG® 17F Little	4 m	DD	BSB 35-50 Tuchel 5-pol.	High Flex Leder	7L2FH043520001B01
	8 m	DD	BSB 35-50 Tuchel 5-pol.	High Flex Leder	7L2FH083520001B01

Technische Änderungen vorbehalten • Verkaufspreise = unverbindliche Preisempfehlung - Angebot freibleibend • © Copyright

ABITIG® GRIP / ABITIG® GRIP Little-Brennerpreisliste

passend für WIG-Stromquellen des Fabrikates „ess“

Brennertyp	Länge	Schalterfunktion	maschinenseitiger Anschluss	Schlauchpaketausführung	Bestellnummer
ABITIG® 26	4 m	DD	BSB 35-50 Tuchel 5-pol.	Standard	7S3SK043520001B01
	8 m	DD	BSB 35-50 Tuchel 5-pol.	Standard	7S3SK083520001B01
	4 m	DD	BSB 35-50 Tuchel 5-pol.	High Flex Leder	7S3SH043520001B01
	8 m	DD	BSB 35-50 Tuchel 5-pol.	High Flex Leder	7S3SH083520001B01
ABITIG® 26F	4 m	DD	BSB 35-50 Tuchel 5-pol.	Standard	7S3FK043520001B01
	8 m	DD	BSB 35-50 Tuchel 5-pol.	Standard	7S3FK083520001B01
	4 m	DD	BSB 35-50 Tuchel 5-pol.	High Flex Leder	7S3FH043520001B01
	8 m	DD	BSB 35-50 Tuchel 5-pol.	High Flex Leder	7S3FH083520001B01
ABITIG® 24G	4 m	DD	BSB 35-50 Tuchel 5-pol.	Standard	7S8SK043520001B01
	8 m	DD	BSB 35-50 Tuchel 5-pol.	Standard	7S8SK083520001B01
	4 m	DD	BSB 35-50 Tuchel 5-pol.	High Flex Leder	7S8SH043520001B01
	8 m	DD	BSB 35-50 Tuchel 5-pol.	High Flex Leder	7S8SH083520001B01
ABITIG® 24G Little	4 m	DD	BSB 35-50 Tuchel 5-pol.	High Flex Leder	7L8SH043520001B01
	8 m	DD	BSB 35-50 Tuchel 5-pol.	High Flex Leder	7L8SH083520001B01
ABITIG® 200	4 m	DD	BSB 35-50 Tuchel 5-pol.	Standard	7T4SK043520001B01
	8 m	DD	BSB 35-50 Tuchel 5-pol.	Standard	7T4SK083520001B01
	4 m	DD	BSB 35-50 Tuchel 5-pol.	High Flex Leder	7T4SH043520001B01
	8 m	DD	BSB 35-50 Tuchel 5-pol.	High Flex Leder	7T4SH083520001B01
ABITIG® 200F	4 m	DD	BSB 35-50 Tuchel 5-pol.	Standard	7T4FK043520001B01
	8 m	DD	BSB 35-50 Tuchel 5-pol.	Standard	7T4FK083520001B01
	4 m	DD	BSB 35-50 Tuchel 5-pol.	High Flex Leder	7T4FH043520001B01
	8 m	DD	BSB 35-50 Tuchel 5-pol.	High Flex Leder	7T4FH083520001B01
ABITIG® 150	4 m	DD	BSB 35-50 Tuchel 5-pol.	Standard	7T6SK043520001B01
	8 m	DD	BSB 35-50 Tuchel 5-pol.	Standard	7T6SK083520001B01
	4 m	DD	BSB 35-50 Tuchel 5-pol.	High Flex Leder	7T6SH043520001B01
	8 m	DD	BSB 35-50 Tuchel 5-pol.	High Flex Leder	7T6SH083520001B01
ABITIG® 150 Little	4 m	DD	BSB 35-50 Tuchel 5-pol.	High Flex Leder	7L6SH043520001B01
	8 m	DD	BSB 35-50 Tuchel 5-pol.	High Flex Leder	7L6SH083520001B01
ABITIG® 150F	4 m	DD	BSB 35-50 Tuchel 5-pol.	Standard	7T6FK043520001B01
	8 m	DD	BSB 35-50 Tuchel 5-pol.	Standard	7T6FK083520001B01
	4 m	DD	BSB 35-50 Tuchel 5-pol.	High Flex Leder	7T6FH043520001B01
	8 m	DD	BSB 35-50 Tuchel 5-pol.	High Flex Leder	7T6FH083520001B01
ABITIG® 150F Little	4 m	DD	BSB 35-50 Tuchel 5-pol.	High Flex Leder	7L6FH043520001B01
	8 m	DD	BSB 35-50 Tuchel 5-pol.	High Flex Leder	7L6FH083520001B01

ABITIG® GRIP / ABITIG® GRIP Little-Brennerpreisliste

passend für WIG-Stromquellen des Fabrikates „ess“

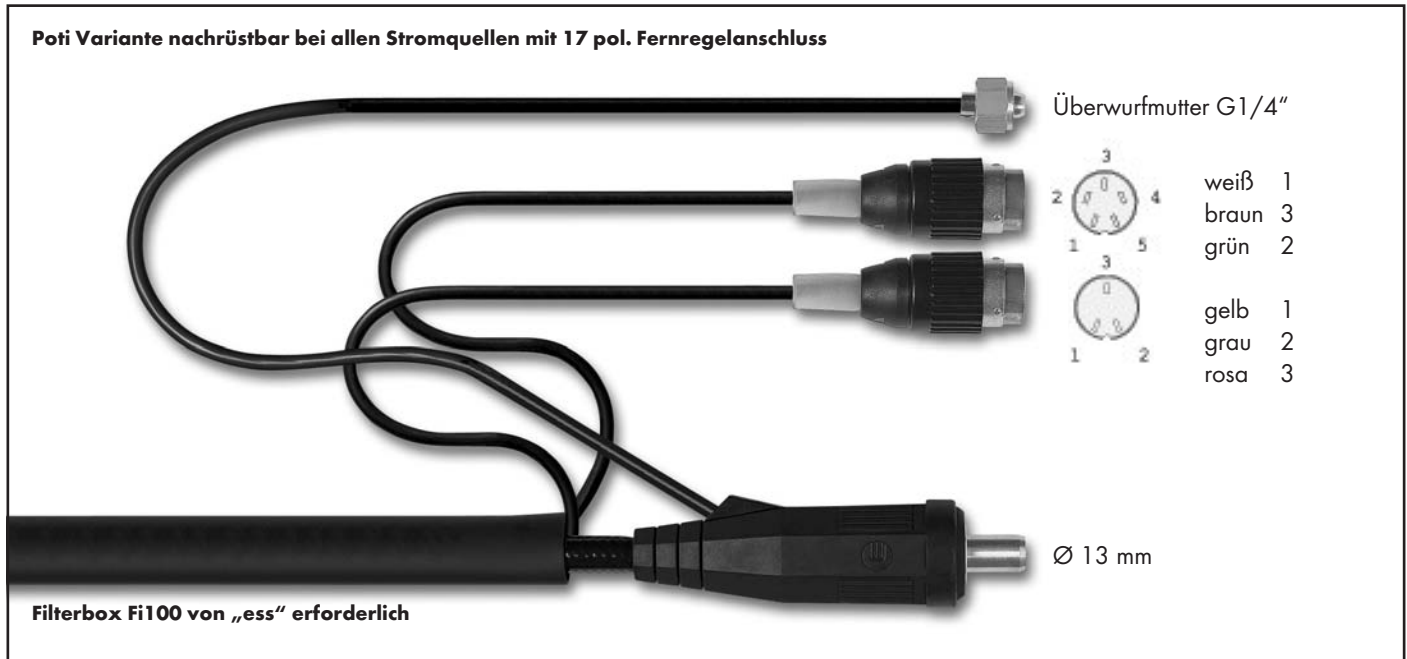

Brennertyp	Länge	Schalterfunktion	maschinenseitiger Anschluss	Schlauchpaketausführung	Bestellnummer
ABITIG® 9	4 m	DDP	BSB 35-50 Tuchel 5-pol./3-pol.	Standard	7S1SK046540052A01
	8 m	DDP	BSB 35-50 Tuchel 5-pol./3-pol.	Standard	7S1SK086540052A01
	4 m	DDP	BSB 35-50 Tuchel 5-pol./3-pol.	High Flex Leder	7S1SH046540052A01
	8 m	DDP	BSB 35-50 Tuchel 5-pol./3-pol.	High Flex Leder	7S1SH086540052A01
ABITIG® 9F	4 m	DDP	BSB 35-50 Tuchel 5-pol./3-pol.	Standard	7S1FK046540052A01
	8 m	DDP	BSB 35-50 Tuchel 5-pol./3-pol.	Standard	7S1FK086540052A01
	4 m	DDP	BSB 35-50 Tuchel 5-pol./3-pol.	High Flex Leder	7S1FH046540052A01
	8 m	DDP	BSB 35-50 Tuchel 5-pol./3-pol.	High Flex Leder	7S1FH086540052A01
ABITIG® 17	4 m	DDP	BSB 35-50 Tuchel 5-pol./3-pol.	Standard	7S2SK046540052A01
	8 m	DDP	BSB 35-50 Tuchel 5-pol./3-pol.	Standard	7S2SK086540052A01
	4 m	DDP	BSB 35-50 Tuchel 5-pol./3-pol.	High Flex Leder	7S2SH046540052A01
	8 m	DDP	BSB 35-50 Tuchel 5-pol./3-pol.	High Flex Leder	7S2SH086540052A01
ABITIG® 17F	4 m	DDP	BSB 35-50 Tuchel 5-pol./3-pol.	Standard	7S2FK046540052A01
	8 m	DDP	BSB 35-50 Tuchel 5-pol./3-pol.	Standard	7S2FK086540052A01
	4 m	DDP	BSB 35-50 Tuchel 5-pol./3-pol.	High Flex Leder	7S2FH046540052A01
	8 m	DDP	BSB 35-50 Tuchel 5-pol./3-pol.	High Flex Leder	7S2FH086540052A01

Technische Änderungen vorbehalten • Verkaufspreise = unverbindliche Preisempfehlung - Angebot freibleibend • © Copyright

ABITIG® GRIP / ABITIG® GRIP Little-Brennerpreisliste

passend für WIG-Stromquellen des Fabrikates „ess“

Brennertyp	Länge	Schalterfunktion	maschinenseitiger Anschluss	Schlauchpaketausführung	Bestellnummer
ABITIG® 26	4 m	DDP	BSB 35-50 Tuchel 5-pol./3-pol.	Standard	7S3SK046540052A01
	8 m	DDP	BSB 35-50 Tuchel 5-pol./3-pol.	Standard	7S3SK086540052A01
	4 m	DDP	BSB 35-50 Tuchel 5-pol./3-pol.	High Flex Leder	7S3SH046540052A01
	8 m	DDP	BSB 35-50 Tuchel 5-pol./3-pol.	High Flex Leder	7S3SH086540052A01
ABITIG® 26F	4 m	DDP	BSB 35-50 Tuchel 5-pol./3-pol.	Standard	7S3FK046540052A01
	8 m	DDP	BSB 35-50 Tuchel 5-pol./3-pol.	Standard	7S3FK086540052A01
	4 m	DDP	BSB 35-50 Tuchel 5-pol./3-pol.	High Flex Leder	7S3FH046540052A01
	8 m	DDP	BSB 35-50 Tuchel 5-pol./3-pol.	High Flex Leder	7S3FH086540052A01
ABITIG® 24G	4 m	DDP	BSB 35-50 Tuchel 5-pol./3-pol.	Standard	7S8SK046540052A01
	8 m	DDP	BSB 35-50 Tuchel 5-pol./3-pol.	Standard	7S8SK086540052A01
	4 m	DDP	BSB 35-50 Tuchel 5-pol./3-pol.	High Flex Leder	7S8SH046540052A01
	8 m	DDP	BSB 35-50 Tuchel 5-pol./3-pol.	High Flex Leder	7S8SH086540052A01
ABITIG® 200	4 m	DDP	BSB 35-50 Tuchel 5-pol./3-pol.	Standard	7T4SK046540052A01
	8 m	DDP	BSB 35-50 Tuchel 5-pol./3-pol.	Standard	7T4SK086540052A01
	4 m	DDP	BSB 35-50 Tuchel 5-pol./3-pol.	High Flex Leder	7T4SH046540052A01
	8 m	DDP	BSB 35-50 Tuchel 5-pol./3-pol.	High Flex Leder	7T4SH086540052A01
ABITIG® 200F	4 m	DDP	BSB 35-50 Tuchel 5-pol./3-pol.	Standard	7T4FK046540052A01
	8 m	DDP	BSB 35-50 Tuchel 5-pol./3-pol.	Standard	7T4FK086540052A01
	4 m	DDP	BSB 35-50 Tuchel 5-pol./3-pol.	High Flex Leder	7T4FH046540052A01
	8 m	DDP	BSB 35-50 Tuchel 5-pol./3-pol.	High Flex Leder	7T4FH086540052A01
ABITIG® 150	4 m	DDP	BSB 35-50 Tuchel 5-pol./3-pol.	Standard	7T6SK046540052A01
	8 m	DDP	BSB 35-50 Tuchel 5-pol./3-pol.	Standard	7T6SK086540052A01
	4 m	DDP	BSB 35-50 Tuchel 5-pol./3-pol.	High Flex Leder	7T6SH046540052A01
	8 m	DDP	BSB 35-50 Tuchel 5-pol./3-pol.	High Flex Leder	7T6SH086540052A01
ABITIG® 150F	4 m	DDP	BSB 35-50 Tuchel 5-pol./3-pol.	Standard	7T6FK046540052A01
	8 m	DDP	BSB 35-50 Tuchel 5-pol./3-pol.	Standard	7T6FK086540052A01
	4 m	DDP	BSB 35-50 Tuchel 5-pol./3-pol.	High Flex Leder	7T6FH046540052A01
	8 m	DDP	BSB 35-50 Tuchel 5-pol./3-pol.	High Flex Leder	7T6FH086540052A01

ABITIG® GRIP / ABITIG® GRIP Little-Brennerpreisliste

passend für WIG-Stromquellen des Fabrikates „ess“

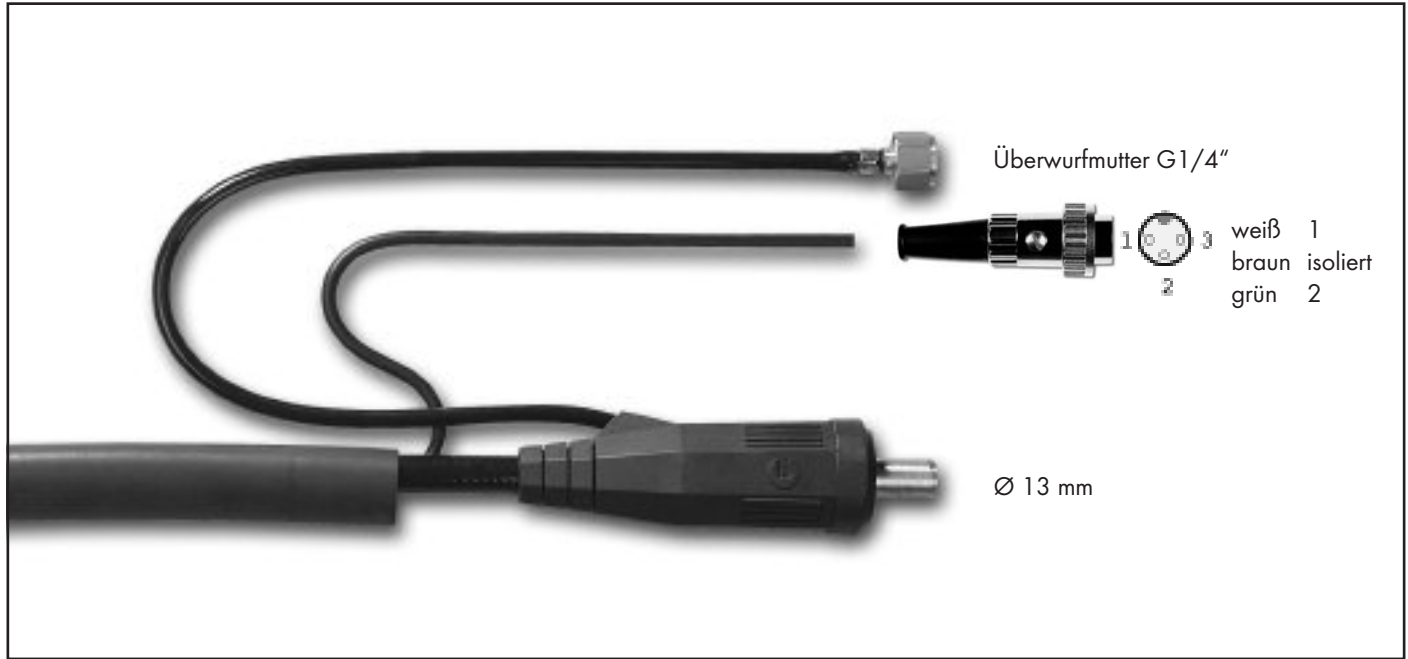

Brennertyp	Länge	Schalterfunktion	maschinenseitiger Anschluss	Schlauchpaketausführung	Bestellnummer
ABITIG® 9	4 m	ED	BSB 35-50 / Dioden-Stecker 3-pol.	Standard	7S1SK043510024A01
	8 m	ED	BSB 35-50 / Dioden-Stecker 3-pol.	Standard	7S1SK083510024A01
	4 m	ED	BSB 35-50 / Dioden-Stecker 3-pol.	High Flex Leder	7S1SH043510024A01
	8 m	ED	BSB 35-50 / Dioden-Stecker 3-pol.	High Flex Leder	7S1SH083510024A01
ABITIG® 9 Little	4 m	ED	BSB 35-50 / Dioden-Stecker 3-pol.	High Flex Leder	7L1SH043510024A01
	8 m	ED	BSB 35-50 / Dioden-Stecker 3-pol.	High Flex Leder	7L1SH083510024A01
ABITIG® 9F	4 m	ED	BSB 35-50 / Dioden-Stecker 3-pol.	Standard	7S1FK043510024A01
	8 m	ED	BSB 35-50 / Dioden-Stecker 3-pol.	Standard	7S1FK083510024A01
	4 m	ED	BSB 35-50 / Dioden-Stecker 3-pol.	High Flex Leder	7S1FH043510024A01
	8 m	ED	BSB 35-50 / Dioden-Stecker 3-pol.	High Flex Leder	7S1FH083510024A01
ABITIG® 9F Little	4 m	ED	BSB 35-50 / Dioden-Stecker 3-pol.	High Flex Leder	7L1FH043510024A01
	8 m	ED	BSB 35-50 / Dioden-Stecker 3-pol.	High Flex Leder	7L1FH083510024A01
ABITIG® 17	4 m	ED	BSB 35-50 / Dioden-Stecker 3-pol.	Standard	7S2SK043510024A01
	8 m	ED	BSB 35-50 / Dioden-Stecker 3-pol.	Standard	7S2SK083510024A01
	4 m	ED	BSB 35-50 / Dioden-Stecker 3-pol.	High Flex Leder	7S2SH043510024A01
	8 m	ED	BSB 35-50 / Dioden-Stecker 3-pol.	High Flex Leder	7S2SH083510024A01
ABITIG® 17 Little	4 m	ED	BSB 35-50 / Dioden-Stecker 3-pol.	High Flex Leder	7L2SH043510024A01
	8 m	ED	BSB 35-50 / Dioden-Stecker 3-pol.	High Flex Leder	7L2SH083510024A01
ABITIG® 17F	4 m	ED	BSB 35-50 / Dioden-Stecker 3-pol.	Standard	7S2FK043510024A01
	8 m	ED	BSB 35-50 / Dioden-Stecker 3-pol.	Standard	7S2FK083510024A01
	4 m	ED	BSB 35-50 / Dioden-Stecker 3-pol.	High Flex Leder	7S2FH043510024A01
	8 m	ED	BSB 35-50 / Dioden-Stecker 3-pol.	High Flex Leder	7S2FH083510024A01
ABITIG® 17F Little	4 m	ED	BSB 35-50 / Dioden-Stecker 3-pol.	High Flex Leder	7L2FH043510024A01
	8 m	ED	BSB 35-50 / Dioden-Stecker 3-pol.	High Flex Leder	7L2FH083510024A01

Technische Änderungen vorbehalten • Verkaufspreise = unverbindliche Preisempfehlung - Angebot freibleibend • © Copyright

ABITIG® GRIP / ABITIG® GRIP Little-Brennerpreisliste

passend für WIG-Stromquellen des Fabrikates „ess“

Brennertyp	Länge	Schalterfunktion	maschinenseitiger Anschluss	Schlauchpaketausführung	Bestellnummer
ABITIG® 26	4 m	ED	BSB 35-50 / Dioden-Stecker 3-pol.	Standard	7S3SK043510024A01
	8 m	ED	BSB 35-50 / Dioden-Stecker 3-pol.	Standard	7S3SK083510024A01
	4 m	ED	BSB 35-50 / Dioden-Stecker 3-pol.	High Flex Leder	7S3SH043510024A01
	8 m	ED	BSB 35-50 / Dioden-Stecker 3-pol.	High Flex Leder	7S3SH083510024A01
ABITIG® 26F	4 m	ED	BSB 35-50 / Dioden-Stecker 3-pol.	Standard	7S3FK043510024A01
	8 m	ED	BSB 35-50 / Dioden-Stecker 3-pol.	Standard	7S3FK083510024A01
	4 m	ED	BSB 35-50 / Dioden-Stecker 3-pol.	High Flex Leder	7S3FH043510024A01
	8 m	ED	BSB 35-50 / Dioden-Stecker 3-pol.	High Flex Leder	7S3FH083510024A01
ABITIG® 24G	4 m	ED	BSB 35-50 / Dioden-Stecker 3-pol.	Standard	7S8SK043510024A01
	8 m	ED	BSB 35-50 / Dioden-Stecker 3-pol.	Standard	7S8SK083510024A01
	4 m	ED	BSB 35-50 / Dioden-Stecker 3-pol.	High Flex Leder	7S8SH043510024A01
	8 m	ED	BSB 35-50 / Dioden-Stecker 3-pol.	High Flex Leder	7S8SH083510024A01
ABITIG® 24G Little	4 m	ED	BSB 35-50 / Dioden-Stecker 3-pol.	High Flex Leder	7L8SH043510024A01
	8 m	ED	BSB 35-50 / Dioden-Stecker 3-pol.	High Flex Leder	7L8SH083510024A01
ABITIG® 200	4 m	ED	BSB 35-50 / Dioden-Stecker 3-pol.	Standard	7T4SK043510024A01
	8 m	ED	BSB 35-50 / Dioden-Stecker 3-pol.	Standard	7T4SK083510024A01
	4 m	ED	BSB 35-50 / Dioden-Stecker 3-pol.	High Flex Leder	7T4SH043510024A01
	8 m	ED	BSB 35-50 / Dioden-Stecker 3-pol.	High Flex Leder	7T4SH083510024A01
ABITIG® 200F	4 m	ED	BSB 35-50 / Dioden-Stecker 3-pol.	Standard	7T4FK043510024A01
	8 m	ED	BSB 35-50 / Dioden-Stecker 3-pol.	Standard	7T4FK083510024A01
	4 m	ED	BSB 35-50 / Dioden-Stecker 3-pol.	High Flex Leder	7T4FH043510024A01
	8 m	ED	BSB 35-50 / Dioden-Stecker 3-pol.	High Flex Leder	7T4FH083510024A01
ABITIG® 150	4 m	ED	BSB 35-50 / Dioden-Stecker 3-pol.	Standard	7T6SK043510024A01
	8 m	ED	BSB 35-50 / Dioden-Stecker 3-pol.	Standard	7T6SK083510024A01
	4 m	ED	BSB 35-50 / Dioden-Stecker 3-pol.	High Flex Leder	7T6SH043510024A01
	8 m	ED	BSB 35-50 / Dioden-Stecker 3-pol.	High Flex Leder	7T6SH083510024A01
ABITIG® 150 Little	4 m	ED	BSB 35-50 / Dioden-Stecker 3-pol.	High Flex Leder	7L6SH043510024A01
	8 m	ED	BSB 35-50 / Dioden-Stecker 3-pol.	High Flex Leder	7L6SH083510024A01
ABITIG® 150F	4 m	ED	BSB 35-50 / Dioden-Stecker 3-pol.	Standard	7T6FK043510024A01
	8 m	ED	BSB 35-50 / Dioden-Stecker 3-pol.	Standard	7T6FK083510024A01
	4 m	ED	BSB 35-50 / Dioden-Stecker 3-pol.	High Flex Leder	7T6FH043510024A01
	8 m	ED	BSB 35-50 / Dioden-Stecker 3-pol.	High Flex Leder	7T6FH083510024A01
ABITIG® 150F Little	4 m	ED	BSB 35-50 / Dioden-Stecker 3-pol.	High Flex Leder	7L6FH043510024A01
	8 m	ED	BSB 35-50 / Dioden-Stecker 3-pol.	High Flex Leder	7L6FH083510024A01

ABITIG® GRIP / ABITIG® GRIP Little-Brennerpreisliste

passend für WIG-Stromquellen des Fabrikates „ess“



Brennertyp	Länge	Schalterfunktion	maschinenseitiger Anschluss	Schlauchpaketausführung	Bestellnummer
ABITIG® 9	4 m	DD	BSB 35-50 Tuchel 5-pol.	Standard	7S1SK043520001B05
	8 m	DD	BSB 35-50 Tuchel 5-pol.	Standard	7S1SK083520001B05
	4 m	DD	BSB 35-50 Tuchel 5-pol.	High Flex Leder	7S1SH043520001B05
	8 m	DD	BSB 35-50 Tuchel 5-pol.	High Flex Leder	7S1SH083520001B05
ABITIG® 9 Little	4 m	DD	BSB 35-50 Tuchel 5-pol.	High Flex Leder	7L1SH043520001B05
	8 m	DD	BSB 35-50 Tuchel 5-pol.	High Flex Leder	7L1SH083520001B05
ABITIG® 9F	4 m	DD	BSB 35-50 Tuchel 5-pol.	Standard	7S1FK043520001B05
	8 m	DD	BSB 35-50 Tuchel 5-pol.	Standard	7S1FK083520001B05
	4 m	DD	BSB 35-50 Tuchel 5-pol.	High Flex Leder	7S1FH043520001B05
	8 m	DD	BSB 35-50 Tuchel 5-pol.	High Flex Leder	7S1FH083520001B05
ABITIG® 9F Little	4 m	DD	BSB 35-50 Tuchel 5-pol.	High Flex Leder	7L1FH043520001B05
	8 m	DD	BSB 35-50 Tuchel 5-pol.	High Flex Leder	7L1FH083520001B05
ABITIG® 17	4 m	DD	BSB 35-50 Tuchel 5-pol.	Standard	7S2SK043520001B05
	8 m	DD	BSB 35-50 Tuchel 5-pol.	Standard	7S2SK083520001B05
	4 m	DD	BSB 35-50 Tuchel 5-pol.	High Flex Leder	7S2SH043520001B05
	8 m	DD	BSB 35-50 Tuchel 5-pol.	High Flex Leder	7S2SH083520001B05
ABITIG® 17 Little	4 m	DD	BSB 35-50 Tuchel 5-pol.	High Flex Leder	7L2SH043520001B05
	8 m	DD	BSB 35-50 Tuchel 5-pol.	High Flex Leder	7L2SH083520001B05
ABITIG® 17F	4 m	DD	BSB 35-50 Tuchel 5-pol.	Standard	7S2FK043520001B05
	8 m	DD	BSB 35-50 Tuchel 5-pol.	Standard	7S2FK083520001B05
	4 m	DD	BSB 35-50 Tuchel 5-pol.	High Flex Leder	7S2FH043520001B05
	8 m	DD	BSB 35-50 Tuchel 5-pol.	High Flex Leder	7S2FH083520001B05
ABITIG® 17F Little	4 m	DD	BSB 35-50 Tuchel 5-pol.	High Flex Leder	7L2FH043520001B05
	8 m	DD	BSB 35-50 Tuchel 5-pol.	High Flex Leder	7L2FH083520001B05

Technische Änderungen vorbehalten • Verkaufspreise = unverbindliche Preisempfehlung - Angebot freibleibend • © Copyright

ABITIG® GRIP / ABITIG® GRIP Little-Brennerpreisliste

passend für WIG-Stromquellen des Fabrikates „ess“

Brennertyp	Länge	Schalterfunktion	maschinenseitiger Anschluss	Schlauchpaketausführung	Bestellnummer
ABITIG® 26	4 m	DD	BSB 35-50 Tuchel 5-pol.	Standard	7S3SK043520001B05
	8 m	DD	BSB 35-50 Tuchel 5-pol.	Standard	7S3SK083520001B05
	4 m	DD	BSB 35-50 Tuchel 5-pol.	High Flex Leder	7S3SH043520001B05
	8 m	DD	BSB 35-50 Tuchel 5-pol.	High Flex Leder	7S3SH083520001B05
ABITIG® 26F	4 m	DD	BSB 35-50 Tuchel 5-pol.	Standard	7S3FK043520001B05
	8 m	DD	BSB 35-50 Tuchel 5-pol.	Standard	7S3FK083520001B05
	4 m	DD	BSB 35-50 Tuchel 5-pol.	High Flex Leder	7S3FH043520001B05
	8 m	DD	BSB 35-50 Tuchel 5-pol.	High Flex Leder	7S3FH083520001B05
ABITIG® 24G	4 m	DD	BSB 35-50 Tuchel 5-pol.	Standard	7S8SK043520001B05
	8 m	DD	BSB 35-50 Tuchel 5-pol.	Standard	7S8SK083520001B05
	4 m	DD	BSB 35-50 Tuchel 5-pol.	High Flex Leder	7S8SH043520001B05
	8 m	DD	BSB 35-50 Tuchel 5-pol.	High Flex Leder	7S8SH083520001B05
ABITIG® 24G Little	4 m	DD	BSB 35-50 Tuchel 5-pol.	High Flex Leder	7L8SH043520001B05
	8 m	DD	BSB 35-50 Tuchel 5-pol.	High Flex Leder	7L8SH083520001B05
ABITIG® 200	4 m	DD	BSB 35-50 Tuchel 5-pol.	Standard	7T4SK043520001B05
	8 m	DD	BSB 35-50 Tuchel 5-pol.	Standard	7T4SK083520001B05
	4 m	DD	BSB 35-50 Tuchel 5-pol.	High Flex Leder	7T4SH043520001B05
	8 m	DD	BSB 35-50 Tuchel 5-pol.	High Flex Leder	7T4SH083520001B05
ABITIG® 200F	4 m	DD	BSB 35-50 Tuchel 5-pol.	Standard	7T4FK043520001B05
	8 m	DD	BSB 35-50 Tuchel 5-pol.	Standard	7T4FK083520001B05
	4 m	DD	BSB 35-50 Tuchel 5-pol.	High Flex Leder	7T4FH043520001B05
	8 m	DD	BSB 35-50 Tuchel 5-pol.	High Flex Leder	7T4FH083520001B05
ABITIG® 150	4 m	DD	BSB 35-50 Tuchel 5-pol.	Standard	7T6SK043520001B05
	8 m	DD	BSB 35-50 Tuchel 5-pol.	Standard	7T6SK083520001B05
	4 m	DD	BSB 35-50 Tuchel 5-pol.	High Flex Leder	7T6SH043520001B05
	8 m	DD	BSB 35-50 Tuchel 5-pol.	High Flex Leder	7T6SH083520001B05
ABITIG® 150 Little	4 m	DD	BSB 35-50 Tuchel 5-pol.	High Flex Leder	7L6SH043520001B05
	8 m	DD	BSB 35-50 Tuchel 5-pol.	High Flex Leder	7L6SH083520001B05
ABITIG® 150F	4 m	DD	BSB 35-50 Tuchel 5-pol.	Standard	7T6FK043520001B05
	8 m	DD	BSB 35-50 Tuchel 5-pol.	Standard	7T6FK083520001B05
	4 m	DD	BSB 35-50 Tuchel 5-pol.	High Flex Leder	7T6FH043520001B05
	8 m	DD	BSB 35-50 Tuchel 5-pol.	High Flex Leder	7T6FH083520001B05
ABITIG® 150F Little	4 m	DD	BSB 35-50 Tuchel 5-pol.	High Flex Leder	7L6FH043520001B05
	8 m	DD	BSB 35-50 Tuchel 5-pol.	High Flex Leder	7L6FH083520001B05

ABITIG® GRIP / ABITIG® GRIP Little-Brennerpreisliste

passend für WIG-Stromquellen des Fabrikates „ess“



Brennertyp	Länge	Schalterfunktion	maschinenseitiger Anschluss	Schlauchpaketausführung	Bestellnummer
ABITIG® 18	4 m	ED	EA Tuchel 5-pol.	Standard	7S4SK043510802A15
	8 m	ED	EA Tuchel 5-pol.	Standard	7S4SK083510802A15
	4 m	ED	EA Tuchel 5-pol.	High Flex Leder	7S4SH043510802A15
	8 m	ED	EA Tuchel 5-pol.	High Flex Leder	7S4SH083510802A15
ABITIG® 18F	4 m	ED	EA Tuchel 5-pol.	Standard	7S4FK043510802A15
	8 m	ED	EA Tuchel 5-pol.	Standard	7S4FK083510802A15
	4 m	ED	EA Tuchel 5-pol.	High Flex Leder	7S4FH043510802A15
	8 m	ED	EA Tuchel 5-pol.	High Flex Leder	7S4FH083510802A15
ABITIG® 20	4 m	ED	EA Tuchel 5-pol.	Standard	7S5SK043510802A15
	8 m	ED	EA Tuchel 5-pol.	Standard	7S5SK083510802A15
	4 m	ED	EA Tuchel 5-pol.	High Flex Leder	7S5SH043510802A15
	8 m	ED	EA Tuchel 5-pol.	High Flex Leder	7S5SH083510802A15
ABITIG® 20 Little	4 m	ED	EA Tuchel 5-pol.	High Flex Leder	7L5SH043510802A15
	8 m	ED	EA Tuchel 5-pol.	High Flex Leder	7L5SH083510802A15
ABITIG® 20F	4 m	ED	EA Tuchel 5-pol.	Standard	7S5FK043510802A15
	8 m	ED	EA Tuchel 5-pol.	Standard	7S5FK083510802A15
	4 m	ED	EA Tuchel 5-pol.	High Flex Leder	7S5FH043510802A15
	8 m	ED	EA Tuchel 5-pol.	High Flex Leder	7S5FH083510802A15
ABITIG® 20F Little	4 m	ED	EA Tuchel 5-pol.	High Flex Leder	7L5FH043510802A15
	8 m	ED	EA Tuchel 5-pol.	High Flex Leder	7L5FH083510802A15

Technische Änderungen vorbehalten • Verkaufspreise = unverbindliche Preisempfehlung - Angebot freibleibend • © Copyright

ABITIG® GRIP / ABITIG® GRIP Little-Brennerpreisliste

passend für WIG-Stromquellen des Fabrikates „ess“

Brennertyp	Länge	Schalterfunktion	maschinenseitiger Anschluss	Schlauchpaketausführung	Bestellnummer
ABITIG® 12-1	4 m	ED	EA Tuchel 5-pol.	Standard	7S6SK043510802A15
	8 m	ED	EA Tuchel 5-pol.	Standard	7S6SK083510802A15
	4 m	ED	EA Tuchel 5-pol.	High Flex Leder	7S6SH043510802A15
	8 m	ED	EA Tuchel 5-pol.	High Flex Leder	7S6SH083510802A15
ABITIG® 18SC	4 m	ED	EA Tuchel 5-pol.	Standard	7S7SK043510802A15
	8 m	ED	EA Tuchel 5-pol.	Standard	7S7SK083510802A15
	4 m	ED	EA Tuchel 5-pol.	High Flex Leder	7S7SH043510802A15
	8 m	ED	EA Tuchel 5-pol.	High Flex Leder	7S7SH083510802A15
ABITIG® 24W	4 m	ED	EA Tuchel 5-pol.	Standard	7S9SK043510802A15
	8 m	ED	EA Tuchel 5-pol.	Standard	7S9SK083510802A15
	4 m	ED	EA Tuchel 5-pol.	High Flex Leder	7S9SH043510802A15
	8 m	ED	EA Tuchel 5-pol.	High Flex Leder	7S9SH083510802A15
ABITIG® 24W Little	4 m	ED	EA Tuchel 5-pol.	High Flex Leder	7L9SH043510802A15
	8 m	ED	EA Tuchel 5-pol.	High Flex Leder	7L9SH083510802A15
ABITIG® 450W	4 m	ED	EA Tuchel 5-pol.	Standard	7T5SK043510802A15
	8 m	ED	EA Tuchel 5-pol.	Standard	7T5SK083510802A15
	4 m	ED	EA Tuchel 5-pol.	High Flex Leder	7T5SH043510802A15
	8 m	ED	EA Tuchel 5-pol.	High Flex Leder	7T5SH083510802A15
ABITIG® 260W	4 m	ED	EA Tuchel 5-pol.	Standard	7T7SK043510802A15
	8 m	ED	EA Tuchel 5-pol.	Standard	7T7SK083510802A15
	4 m	ED	EA Tuchel 5-pol.	High Flex Leder	7T7SH043510802A15
	8 m	ED	EA Tuchel 5-pol.	High Flex Leder	7T7SH083510802A15
ABITIG® 260W Little	4 m	ED	EA Tuchel 5-pol.	High Flex Leder	7L7SH043510802A15
	8 m	ED	EA Tuchel 5-pol.	High Flex Leder	7L7SH083510802A15
ABITIG® 450W SC	4 m	ED	EA Tuchel 5-pol.	Standard	
	8 m	ED	EA Tuchel 5-pol.	Standard	
	4 m	ED	EA Tuchel 5-pol.	High Flex Leder	7T8SH043510802A15
	8 m	ED	EA Tuchel 5-pol.	High Flex Leder	7T8SH083510802A15

ABITIG® GRIP / ABITIG® GRIP Little-Brennerpreisliste

passend für WIG-Stromquellen des Fabrikates „ess“



Brennertyp	Länge	Schalterfunktion	maschinenseitiger Anschluss	Schlauchpaketausführung	Bestellnummer
ABITIG® 18	4 m	ED	BSB 35-50 Tuchel 5-pol.	Standard	7S4SK043510002A30
	8 m	ED	BSB 35-50 Tuchel 5-pol.	Standard	7S4SK083510002A30
	4 m	ED	BSB 35-50 Tuchel 5-pol.	High Flex Leder	7S4SH043510002A30
	8 m	ED	BSB 35-50 Tuchel 5-pol.	High Flex Leder	7S4SH083510002A30
ABITIG® 18F	4 m	ED	BSB 35-50 Tuchel 5-pol.	Standard	7S4FK043510002A30
	8 m	ED	BSB 35-50 Tuchel 5-pol.	Standard	7S4FK083510002A30
	4 m	ED	BSB 35-50 Tuchel 5-pol.	High Flex Leder	7S4FH043510002A30
	8 m	ED	BSB 35-50 Tuchel 5-pol.	High Flex Leder	7S4FH083510002A30
ABITIG® 20	4 m	ED	BSB 35-50 Tuchel 5-pol.	Standard	7S5SK043510002A30
	8 m	ED	BSB 35-50 Tuchel 5-pol.	Standard	7S5SK083510002A30
	4 m	ED	BSB 35-50 Tuchel 5-pol.	High Flex Leder	7S5SH043510002A30
	8 m	ED	BSB 35-50 Tuchel 5-pol.	High Flex Leder	7S5SH083510002A30
ABITIG® 20 Little	4 m	ED	BSB 35-50 Tuchel 5-pol.	High Flex Leder	7L5SH043510002A30
	8 m	ED	BSB 35-50 Tuchel 5-pol.	High Flex Leder	7L5SH083510002A30
ABITIG® 20F	4 m	ED	BSB 35-50 Tuchel 5-pol.	Standard	7S5FK043510002A30
	8 m	ED	BSB 35-50 Tuchel 5-pol.	Standard	7S5FK083510002A30
	4 m	ED	BSB 35-50 Tuchel 5-pol.	High Flex Leder	7S5FH043510002A30
	8 m	ED	BSB 35-50 Tuchel 5-pol.	High Flex Leder	7S5FH083510002A30
ABITIG® 20F Little	4 m	ED	BSB 35-50 Tuchel 5-pol.	High Flex Leder	7L5FH043510002A30
	8 m	ED	BSB 35-50 Tuchel 5-pol.	High Flex Leder	7L5FH083510002A30

Technische Änderungen vorbehalten • Verkaufspreise = unverbindliche Preisempfehlung - Angebot freibleibend • © Copyright

ABITIG® GRIP / ABITIG® GRIP Little-Brennerpreisliste

passend für WIG-Stromquellen des Fabrikates „ess“

Brennertyp	Länge	Schalterfunktion	maschinenseitiger Anschluss	Schlauchpaketausführung	Bestellnummer
ABITIG® 12-1	4 m	ED	BSB 35-50 Tuchel 5-pol.	Standard	7S6SK043510002A30
	8 m	ED	BSB 35-50 Tuchel 5-pol.	Standard	7S6SK083510002A30
	4 m	ED	BSB 35-50 Tuchel 5-pol.	High Flex Leder	7S6SH043510002A30
	8 m	ED	BSB 35-50 Tuchel 5-pol.	High Flex Leder	7S6SH083510002A30
ABITIG® 18SC	4 m	ED	BSB 35-50 Tuchel 5-pol.	Standard	7S7SK043510002A30
	8 m	ED	BSB 35-50 Tuchel 5-pol.	Standard	7S7SK083510002A30
	4 m	ED	BSB 35-50 Tuchel 5-pol.	High Flex Leder	7S7SH043510002A30
	8 m	ED	BSB 35-50 Tuchel 5-pol.	High Flex Leder	7S7SH083510002A30
ABITIG® 24W	4 m	ED	BSB 35-50 Tuchel 5-pol.	Standard	7S9SK043510002A30
	8 m	ED	BSB 35-50 Tuchel 5-pol.	Standard	7S9SK083510002A30
	4 m	ED	BSB 35-50 Tuchel 5-pol.	High Flex Leder	7S9SH043510002A30
	8 m	ED	BSB 35-50 Tuchel 5-pol.	High Flex Leder	7S9SH083510002A30
ABITIG® 24W Little	4 m	ED	BSB 35-50 Tuchel 5-pol.	High Flex Leder	7L9SH043510002A30
	8 m	ED	BSB 35-50 Tuchel 5-pol.	High Flex Leder	7L9SH083510002A30
ABITIG® 450W	4 m	ED	BSB 35-50 Tuchel 5-pol.	Standard	7T5SK043510102A30
	8 m	ED	BSB 35-50 Tuchel 5-pol.	Standard	7T5SK083510102A30
	4 m	ED	BSB 35-50 Tuchel 5-pol.	High Flex Leder	7T5SH043510102A30
	8 m	ED	BSB 35-50 Tuchel 5-pol.	High Flex Leder	7T5SH083510102A30
ABITIG® 260W	4 m	ED	BSB 35-50 Tuchel 5-pol.	Standard	7T7SK043510102A30
	8 m	ED	BSB 35-50 Tuchel 5-pol.	Standard	7T7SK083510102A30
	4 m	ED	BSB 35-50 Tuchel 5-pol.	High Flex Leder	7T7SH043510102A30
	8 m	ED	BSB 35-50 Tuchel 5-pol.	High Flex Leder	7T7SH083510102A30
ABITIG® 260W Little	4 m	ED	BSB 35-50 Tuchel 5-pol.	High Flex Leder	7L7SH043510102A30
	8 m	ED	BSB 35-50 Tuchel 5-pol.	High Flex Leder	7L7SH083510102A30
ABITIG® 450W SC	4 m	ED	BSB 35-50 Tuchel 5-pol.	Standard	
	8 m	ED	BSB 35-50 Tuchel 5-pol.	Standard	
	4 m	ED	BSB 35-50 Tuchel 5-pol.	High Flex Leder	7T8SH043510102A30
	8 m	ED	BSB 35-50 Tuchel 5-pol.	High Flex Leder	7T8SH083510102A30

ABITIG® GRIP / ABITIG® GRIP Little-Brennerpreisliste

passend für WIG-Stromquellen des Fabrikates „ess“



Brennertyp	Länge	Schalterfunktion	maschinenseitiger Anschluss	Schlauchpaketausführung	Bestellnummer
ABITIG® 18	4 m	DD	EA Tuchel 5-pol.	Standard	7S4SK043520801B15
	8 m	DD	EA Tuchel 5-pol.	Standard	7S4SK083520801B15
	4 m	DD	EA Tuchel 5-pol.	High Flex Leder	7S4SH043520801B15
	8 m	DD	EA Tuchel 5-pol.	High Flex Leder	7S4SH083520801B15
ABITIG® 18F	4 m	DD	EA Tuchel 5-pol.	Standard	7S4FK043520801B15
	8 m	DD	EA Tuchel 5-pol.	Standard	7S4FK083520801B15
	4 m	DD	EA Tuchel 5-pol.	High Flex Leder	7S4FH043520801B15
	8 m	DD	EA Tuchel 5-pol.	High Flex Leder	7S4FH083520801B15
ABITIG® 20	4 m	DD	EA Tuchel 5-pol.	Standard	7S5SK043520801B15
	8 m	DD	EA Tuchel 5-pol.	Standard	7S5SK083520801B15
	4 m	DD	EA Tuchel 5-pol.	High Flex Leder	7S5SH043520801B15
	8 m	DD	EA Tuchel 5-pol.	High Flex Leder	7S5SH083520801B15
ABITIG® 20 Little	4 m	DD	EA Tuchel 5-pol.	High Flex Leder	7L5SH043520801B15
	8 m	DD	EA Tuchel 5-pol.	High Flex Leder	7L5SH083520801B15
ABITIG® 20F	4 m	DD	EA Tuchel 5-pol.	Standard	7S5FK043520801B15
	8 m	DD	EA Tuchel 5-pol.	Standard	7S5FK083520801B15
	4 m	DD	EA Tuchel 5-pol.	High Flex Leder	7S5FH043520801B15
	8 m	DD	EA Tuchel 5-pol.	High Flex Leder	7S5FH083520801B15
ABITIG® 20F Little	4 m	DD	EA Tuchel 5-pol.	High Flex Leder	7L5FH043520801B15
	8 m	DD	EA Tuchel 5-pol.	High Flex Leder	7L5FH083520801B15

Technische Änderungen vorbehalten • Verkaufspreise = unverbindliche Preisempfehlung - Angebot freibleibend • © Copyright

ABITIG® GRIP / ABITIG® GRIP Little-Brennerpreisliste

passend für WIG-Stromquellen des Fabrikates „ess“

Brennertyp	Länge	Schalterfunktion	maschinenseitiger Anschluss	Schlauchpaketausführung	Bestellnummer
ABITIG® 12-1	4 m	DD	EA Tuchel 5-pol.	Standard	7S6SK043520801B15
	8 m	DD	EA Tuchel 5-pol.	Standard	7S6SK083520801B15
	4 m	DD	EA Tuchel 5-pol.	High Flex Leder	7S6SH043520801B15
	8 m	DD	EA Tuchel 5-pol.	High Flex Leder	7S6SH083520801B15
ABITIG® 18SC	4 m	DD	EA Tuchel 5-pol.	Standard	7S7SK043520801B15
	8 m	DD	EA Tuchel 5-pol.	Standard	7S7SK083520801B15
	4 m	DD	EA Tuchel 5-pol.	High Flex Leder	7S7SH043520801B15
	8 m	DD	EA Tuchel 5-pol.	High Flex Leder	7S7SH083520801B15
ABITIG® 24W	4 m	DD	EA Tuchel 5-pol.	Standard	7S9SK043520801B15
	8 m	DD	EA Tuchel 5-pol.	Standard	7S9SK083520801B15
	4 m	DD	EA Tuchel 5-pol.	High Flex Leder	7S9SH043520801B15
	8 m	DD	EA Tuchel 5-pol.	High Flex Leder	7S9SH083520801B15
ABITIG® 24W Little	4 m	DD	EA Tuchel 5-pol.	High Flex Leder	7L9SH043520801B15
	8 m	DD	EA Tuchel 5-pol.	High Flex Leder	7L9SH083520801B15
ABITIG® 450W	4 m	DD	EA Tuchel 5-pol.	Standard	7T5SK043520801B15
	8 m	DD	EA Tuchel 5-pol.	Standard	7T5SK083520801B15
	4 m	DD	EA Tuchel 5-pol.	High Flex Leder	7T5SH043520801B15
	8 m	DD	EA Tuchel 5-pol.	High Flex Leder	7T5SH083520801B15
ABITIG® 260W	4 m	DD	EA Tuchel 5-pol.	Standard	7T7SK043520801B15
	8 m	DD	EA Tuchel 5-pol.	Standard	7T7SK083520801B15
	4 m	DD	EA Tuchel 5-pol.	High Flex Leder	7T7SH043520801B15
	8 m	DD	EA Tuchel 5-pol.	High Flex Leder	7T7SH083520801B15
ABITIG® 260W Little	4 m	DD	EA Tuchel 5-pol.	High Flex Leder	7L7SH043520801B15
	8 m	DD	EA Tuchel 5-pol.	High Flex Leder	7L7SH083520801B15
ABITIG® 450W SC	4 m	DD	EA Tuchel 5-pol.	Standard	
	8 m	DD	EA Tuchel 5-pol.	Standard	
	4 m	DD	EA Tuchel 5-pol.	High Flex Leder	7T8SH043520801B15
	8 m	DD	EA Tuchel 5-pol.	High Flex Leder	7T8SH083520801B15

ABITIG® GRIP / ABITIG® GRIP Little-Brennerpreisliste

passend für WIG-Stromquellen des Fabrikates „ess“



Brennertyp	Länge	Schalterfunktion	maschinenseitiger Anschluss	Schlauchpaketausführung	Bestellnummer
ABITIG® 18	4 m	DD	BSB 35-50 Tuchel 5-pol.	Standard	7S4SK043520001B30
	8 m	DD	BSB 35-50 Tuchel 5-pol.	Standard	7S4SK083520001B30
	4 m	DD	BSB 35-50 Tuchel 5-pol.	High Flex Leder	7S4SH043520001B30
	8 m	DD	BSB 35-50 Tuchel 5-pol.	High Flex Leder	7S4SH083520001B30
ABITIG® 18F	4 m	DD	BSB 35-50 Tuchel 5-pol.	Standard	7S4FK043520001B30
	8 m	DD	BSB 35-50 Tuchel 5-pol.	Standard	7S4FK083520001B30
	4 m	DD	BSB 35-50 Tuchel 5-pol.	High Flex Leder	7S4FH043520001B30
	8 m	DD	BSB 35-50 Tuchel 5-pol.	High Flex Leder	7S4FH083520001B30
ABITIG® 20	4 m	DD	BSB 35-50 Tuchel 5-pol.	Standard	7S5SK043520001B30
	8 m	DD	BSB 35-50 Tuchel 5-pol.	Standard	7S5SK083520001B30
	4 m	DD	BSB 35-50 Tuchel 5-pol.	High Flex Leder	7S5SH043520001B30
	8 m	DD	BSB 35-50 Tuchel 5-pol.	High Flex Leder	7S5SH083520001B30
ABITIG® 20 Little	4 m	DD	BSB 35-50 Tuchel 5-pol.	High Flex Leder	7L5SH043520001B30
	8 m	DD	BSB 35-50 Tuchel 5-pol.	High Flex Leder	7L5SH083520001B30
ABITIG® 20F	4 m	DD	BSB 35-50 Tuchel 5-pol.	Standard	7S5FK043520001B30
	8 m	DD	BSB 35-50 Tuchel 5-pol.	Standard	7S5FK083520001B30
	4 m	DD	BSB 35-50 Tuchel 5-pol.	High Flex Leder	7S5FH043520001B30
	8 m	DD	BSB 35-50 Tuchel 5-pol.	High Flex Leder	7S5FH083520001B30
ABITIG® 20F Little	4 m	DD	BSB 35-50 Tuchel 5-pol.	High Flex Leder	7L5FH043520001B30
	8 m	DD	BSB 35-50 Tuchel 5-pol.	High Flex Leder	7L5FH083520001B30

Technische Änderungen vorbehalten • Verkaufspreise = unverbindliche Preisempfehlung - Angebot freibleibend • © Copyright

ABITIG® GRIP / ABITIG® GRIP Little-Brennerpreisliste

passend für WIG-Stromquellen des Fabrikates „ess“

Brennertyp	Länge	Schalterfunktion	maschinenseitiger Anschluss	Schlauchpaketausführung	Bestellnummer
ABITIG® 12-1	4 m	DD	BSB 35-50 Tuchel 5-pol.	Standard	7S6SK043520001B30
	8 m	DD	BSB 35-50 Tuchel 5-pol.	Standard	7S6SK083520001B30
	4 m	DD	BSB 35-50 Tuchel 5-pol.	High Flex Leder	7S6SH043520001B30
	8 m	DD	BSB 35-50 Tuchel 5-pol.	High Flex Leder	7S6SH083520001B30
ABITIG® 18SC	4 m	DD	BSB 35-50 Tuchel 5-pol.	Standard	7S7SK043520001B30
	8 m	DD	BSB 35-50 Tuchel 5-pol.	Standard	7S7SK083520001B30
	4 m	DD	BSB 35-50 Tuchel 5-pol.	High Flex Leder	7S7SH043520001B30
	8 m	DD	BSB 35-50 Tuchel 5-pol.	High Flex Leder	7S7SH083520001B30
ABITIG® 24W	4 m	DD	BSB 35-50 Tuchel 5-pol.	Standard	7S9SK043520001B30
	8 m	DD	BSB 35-50 Tuchel 5-pol.	Standard	7S9SK083520001B30
	4 m	DD	BSB 35-50 Tuchel 5-pol.	High Flex Leder	7S9SH043520001B30
	8 m	DD	BSB 35-50 Tuchel 5-pol.	High Flex Leder	7S9SH083520001B30
ABITIG® 24W Little	4 m	DD	BSB 35-50 Tuchel 5-pol.	High Flex Leder	7L9SH043520001B30
	8 m	DD	BSB 35-50 Tuchel 5-pol.	High Flex Leder	7L9SH083520001B30
ABITIG® 450W	4 m	DD	BSB 35-50 Tuchel 5-pol.	Standard	7T5SK043520101B30
	8 m	DD	BSB 35-50 Tuchel 5-pol.	Standard	7T5SK083520101B30
	4 m	DD	BSB 35-50 Tuchel 5-pol.	High Flex Leder	7T5SH043520101B30
	8 m	DD	BSB 35-50 Tuchel 5-pol.	High Flex Leder	7T5SH083520101B30
ABITIG® 260W	4 m	DD	BSB 35-50 Tuchel 5-pol.	Standard	7T7SK043520101B30
	8 m	DD	BSB 35-50 Tuchel 5-pol.	Standard	7T7SK083520101B30
	4 m	DD	BSB 35-50 Tuchel 5-pol.	High Flex Leder	7T7SH043520101B30
	8 m	DD	BSB 35-50 Tuchel 5-pol.	High Flex Leder	7T7SH083520101B30
ABITIG® 260W Little	4 m	DD	BSB 35-50 Tuchel 5-pol.	High Flex Leder	7L7SH043520101B30
	8 m	DD	BSB 35-50 Tuchel 5-pol.	High Flex Leder	7L7SH083520101B30
ABITIG® 450W SC	4 m	DD	BSB 35-50 Tuchel 5-pol.	Standard	
	8 m	DD	BSB 35-50 Tuchel 5-pol.	Standard	
	4 m	DD	BSB 35-50 Tuchel 5-pol.	High Flex Leder	7T8SH043520101B30
	8 m	DD	BSB 35-50 Tuchel 5-pol.	High Flex Leder	7T8SH083520101B30



ABITIG® GRIP / ABITIG® GRIP Little-Brennerpreisliste

passend für WIG-Stromquellen des Fabrikates „ess“

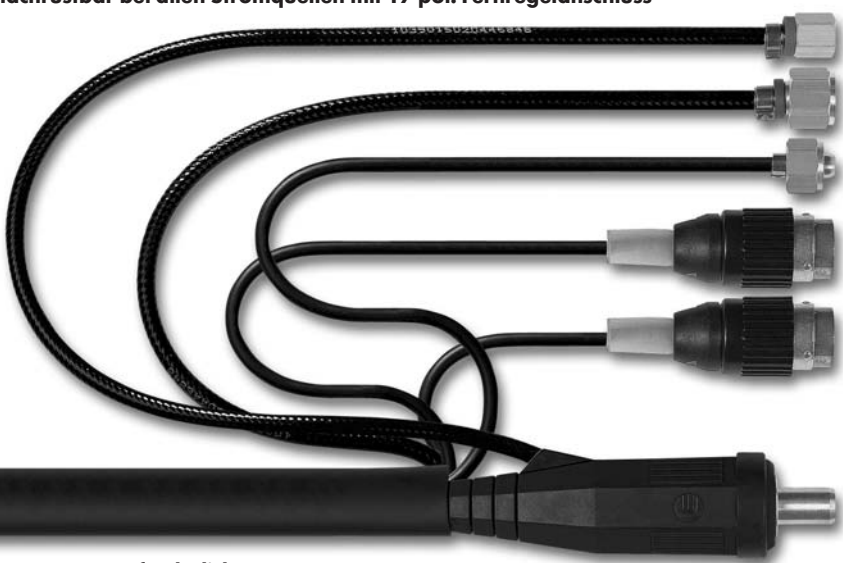
Poti Variante nachrüstbar bei allen Stromquellen mit 17 pol. Fernregelanschluss

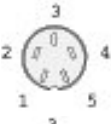

→ Überwurfmutter M12x1
 ← Überwurfmutter G3/8"
 G Überwurfmutter G1/4"

	weiß 1 braun 3 grün 2
	gelb 1 grau 2 rosa 3

Ø 13 mm

Bei ABITIG® 260/450 BCS 01

Filterbox Fi100 von „ess“ erforderlich

Brennertyp	Länge	Schalterfunktion	maschinenseitiger Anschluss	Schlauchpaketausführung	Bestellnummer
ABITIG® 18	4 m	DDP	BSB 35-50 Tuchel 5-pol./3-pol.	Standard	7S4SK046540052A30
	8 m	DDP	BSB 35-50 Tuchel 5-pol./3-pol.	Standard	7S4SK086540052A30
	4 m	DDP	BSB 35-50 Tuchel 5-pol./3-pol.	High Flex Leder	7S4SH046540052A30
	8 m	DDP	BSB 35-50 Tuchel 5-pol./3-pol.	High Flex Leder	7S4SH086540052A30
ABITIG® 18F	4 m	DDP	BSB 35-50 Tuchel 5-pol./3-pol.	Standard	7S4FK046540052A30
	8 m	DDP	BSB 35-50 Tuchel 5-pol./3-pol.	Standard	7S4FK086540052A30
	4 m	DDP	BSB 35-50 Tuchel 5-pol./3-pol.	High Flex Leder	7S4FH046540052A30
	8 m	DDP	BSB 35-50 Tuchel 5-pol./3-pol.	High Flex Leder	7S4FH086540052A30
ABITIG® 20	4 m	DDP	BSB 35-50 Tuchel 5-pol./3-pol.	Standard	7S5SK046540052A30
	8 m	DDP	BSB 35-50 Tuchel 5-pol./3-pol.	Standard	7S5SK086540052A30
	4 m	DDP	BSB 35-50 Tuchel 5-pol./3-pol.	High Flex Leder	7S5SH046540052A30
	8 m	DDP	BSB 35-50 Tuchel 5-pol./3-pol.	High Flex Leder	7S5SH086540052A30
ABITIG® 20F	4 m	DDP	BSB 35-50 Tuchel 5-pol./3-pol.	Standard	7S5FK046540052A30
	8 m	DDP	BSB 35-50 Tuchel 5-pol./3-pol.	Standard	7S5FK086540052A30
	4 m	DDP	BSB 35-50 Tuchel 5-pol./3-pol.	High Flex Leder	7S5FH046540052A30
	8 m	DDP	BSB 35-50 Tuchel 5-pol./3-pol.	High Flex Leder	7S5FH086540052A30

Technische Änderungen vorbehalten • Verkaufspreise = unverbindliche Preisempfehlung - Angebot freibleibend • © Copyright

ABITIG® GRIP / ABITIG® GRIP Little-Brennerpreisliste

passend für WIG-Stromquellen des Fabrikates „ess“

Brennertyp	Länge	Schalterfunktion	maschinenseitiger Anschluss	Schlauchpaketausführung	Bestellnummer
ABITIG® 12-1	4 m	DDP	BSB 35-50 Tuchel 5-pol./3-pol.	Standard	7S6SK046540052A30
	8 m	DDP	BSB 35-50 Tuchel 5-pol./3-pol.	Standard	7S6SK086540052A30
	4 m	DDP	BSB 35-50 Tuchel 5-pol./3-pol.	High Flex Leder	7S6SH046540052A30
	8 m	DDP	BSB 35-50 Tuchel 5-pol./3-pol.	High Flex Leder	7S6SH086540052A30
ABITIG® 18SC	4 m	DDP	BSB 35-50 Tuchel 5-pol./3-pol.	Standard	7S7SK046540052A30
	8 m	DDP	BSB 35-50 Tuchel 5-pol./3-pol.	Standard	7S7SK086540052A30
	4 m	DDP	BSB 35-50 Tuchel 5-pol./3-pol.	High Flex Leder	7S7SH046540052A30
	8 m	DDP	BSB 35-50 Tuchel 5-pol./3-pol.	High Flex Leder	7S7SH086540052A30
ABITIG® 24W	4 m	DDP	BSB 35-50 Tuchel 5-pol./3-pol.	Standard	7S9SK046540052A30
	8 m	DDP	BSB 35-50 Tuchel 5-pol./3-pol.	Standard	7S9SK086540052A30
	4 m	DDP	BSB 35-50 Tuchel 5-pol./3-pol.	High Flex Leder	7S9SH046540052A30
	8 m	DDP	BSB 35-50 Tuchel 5-pol./3-pol.	High Flex Leder	7S9SH086540052A30
ABITIG® 450W	4 m	DDP	BSB 35-50 Tuchel 5-pol./3-pol.	Standard	7T5SK046540152A30
	8 m	DDP	BSB 35-50 Tuchel 5-pol./3-pol.	Standard	7T5SK086540152A30
	4 m	DDP	BSB 35-50 Tuchel 5-pol./3-pol.	High Flex Leder	7T5SH046540152A30
	8 m	DDP	BSB 35-50 Tuchel 5-pol./3-pol.	High Flex Leder	7T5SH086540152A30
ABITIG® 260W	4 m	DDP	BSB 35-50 Tuchel 5-pol./3-pol.	Standard	7T7SK046540152A30
	8 m	DDP	BSB 35-50 Tuchel 5-pol./3-pol.	Standard	7T7SK086540152A30
	4 m	DDP	BSB 35-50 Tuchel 5-pol./3-pol.	High Flex Leder	7T7SH046540152A30
	8 m	DDP	BSB 35-50 Tuchel 5-pol./3-pol.	High Flex Leder	7T7SH086540152A30
ABITIG® 450W SC	4 m	DDP	BSB 35-50 Tuchel 5-pol./3-pol.	Standard	
	8 m	DDP	BSB 35-50 Tuchel 5-pol./3-pol.	Standard	
	4 m	DDP	BSB 35-50 Tuchel 5-pol./3-pol.	High Flex Leder	7T8SH046540152A30
	8 m	DDP	BSB 35-50 Tuchel 5-pol./3-pol.	High Flex Leder	7T8SH086540152A30

ABITIG® GRIP / ABITIG® GRIP Little-Brennerpreisliste

passend für WIG-Stromquellen des Fabrikates „ess“



Brennertyp	Länge	Schalterfunktion	maschinenseitiger Anschluss	Schlauchpaketausführung	Bestellnummer
ABITIG® 18	4 m	DD	BSB 35-50 Tuchel 5-pol.	Standard	7S4SK043520001B16
	8 m	DD	BSB 35-50 Tuchel 5-pol.	Standard	7S4SK083520001B16
	4 m	DD	BSB 35-50 Tuchel 5-pol.	High Flex Leder	7S4SH043520001B16
	8 m	DD	BSB 35-50 Tuchel 5-pol.	High Flex Leder	7S4SH083520001B16
ABITIG® 18F	4 m	DD	BSB 35-50 Tuchel 5-pol.	Standard	7S4FK043520001B16
	8 m	DD	BSB 35-50 Tuchel 5-pol.	Standard	7S4FK083520001B16
	4 m	DD	BSB 35-50 Tuchel 5-pol.	High Flex Leder	7S4FH043520001B16
	8 m	DD	BSB 35-50 Tuchel 5-pol.	High Flex Leder	7S4FH083520001B16
ABITIG® 20	4 m	DD	BSB 35-50 Tuchel 5-pol.	Standard	7S5SK043520001B16
	8 m	DD	BSB 35-50 Tuchel 5-pol.	Standard	7S5SK083520001B16
	4 m	DD	BSB 35-50 Tuchel 5-pol.	High Flex Leder	7S5SH043520001B16
	8 m	DD	BSB 35-50 Tuchel 5-pol.	High Flex Leder	7S5SH083520001B16
ABITIG® 20 Little	4 m	DD	BSB 35-50 Tuchel 5-pol.	High Flex Leder	7L5SH043520001B16
	8 m	DD	BSB 35-50 Tuchel 5-pol.	High Flex Leder	7L5SH083520001B16
ABITIG® 20F	4 m	DD	BSB 35-50 Tuchel 5-pol.	Standard	7S5FK043520001B16
	8 m	DD	BSB 35-50 Tuchel 5-pol.	Standard	7S5FK083520001B16
	4 m	DD	BSB 35-50 Tuchel 5-pol.	High Flex Leder	7S5FH043520001B16
	8 m	DD	BSB 35-50 Tuchel 5-pol.	High Flex Leder	7S5FH083520001B16
ABITIG® 20F Little	4 m	DD	BSB 35-50 Tuchel 5-pol.	High Flex Leder	7L5FH043520001B16
	8 m	DD	BSB 35-50 Tuchel 5-pol.	High Flex Leder	7L5FH083520001B16

Technische Änderungen vorbehalten • Verkaufspreise = unverbindliche Preisempfehlung - Angebot freibleibend • © Copyright

ABITIG® GRIP / ABITIG® GRIP Little-Brennerpreisliste

passend für WIG-Stromquellen des Fabrikates „ess“

Brennertyp	Länge	Schalterfunktion	maschinenseitiger Anschluss	Schlauchpaketausführung	Bestellnummer
ABITIG® 12-1	4 m	DD	BSB 35-50 Tuchel 5-pol.	Standard	7S6SK043520001B16
	8 m	DD	BSB 35-50 Tuchel 5-pol.	Standard	7S6SK083520001B16
	4 m	DD	BSB 35-50 Tuchel 5-pol.	High Flex Leder	7S6SH043520001B16
	8 m	DD	BSB 35-50 Tuchel 5-pol.	High Flex Leder	7S6SH083520001B16
ABITIG® 18SC	4 m	DD	BSB 35-50 Tuchel 5-pol.	Standard	7S7SK043520001B16
	8 m	DD	BSB 35-50 Tuchel 5-pol.	Standard	7S7SK083520001B16
	4 m	DD	BSB 35-50 Tuchel 5-pol.	High Flex Leder	7S7SH043520001B16
	8 m	DD	BSB 35-50 Tuchel 5-pol.	High Flex Leder	7S7SH083520001B16
ABITIG® 24W	4 m	DD	BSB 35-50 Tuchel 5-pol.	Standard	7S9SK043520001B16
	8 m	DD	BSB 35-50 Tuchel 5-pol.	Standard	7S9SK083520001B16
	4 m	DD	BSB 35-50 Tuchel 5-pol.	High Flex Leder	7S9SH043520001B16
	8 m	DD	BSB 35-50 Tuchel 5-pol.	High Flex Leder	7S9SH083520001B16
ABITIG® 24W Little	4 m	DD	BSB 35-50 Tuchel 5-pol.	High Flex Leder	7L9SH043520001B16
	8 m	DD	BSB 35-50 Tuchel 5-pol.	High Flex Leder	7L9SH083520001B16
ABITIG® 450W	4 m	DD	BSB 35-50 Tuchel 5-pol.	Standard	7T5SK043520101B16
	8 m	DD	BSB 35-50 Tuchel 5-pol.	Standard	7T5SK083520101B16
	4 m	DD	BSB 35-50 Tuchel 5-pol.	High Flex Leder	7T5SH043520101B16
	8 m	DD	BSB 35-50 Tuchel 5-pol.	High Flex Leder	7T5SH083520101B16
ABITIG® 260W	4 m	DD	BSB 35-50 Tuchel 5-pol.	Standard	7T7SK043520101B16
	8 m	DD	BSB 35-50 Tuchel 5-pol.	Standard	7T7SK083520101B16
	4 m	DD	BSB 35-50 Tuchel 5-pol.	High Flex Leder	7T7SH043520101B16
	8 m	DD	BSB 35-50 Tuchel 5-pol.	High Flex Leder	7T7SH083520101B16
ABITIG® 260W Little	4 m	DD	BSB 35-50 Tuchel 5-pol.	High Flex Leder	7L7SH043520101B16
	8 m	DD	BSB 35-50 Tuchel 5-pol.	High Flex Leder	7L7SH083520101B16
ABITIG® 450W SC	4 m	DD	BSB 35-50 Tuchel 5-pol.	Standard	
	8 m	DD	BSB 35-50 Tuchel 5-pol.	Standard	
	4 m	DD	BSB 35-50 Tuchel 5-pol.	High Flex Leder	7T8SH043520101B16
	8 m	DD	BSB 35-50 Tuchel 5-pol.	High Flex Leder	7T8SH083520101B16

ABITIG® GRIP / ABITIG® GRIP Little-Brennerpreisliste

passend für WIG-Stromquellen des Fabrikates „eseti“

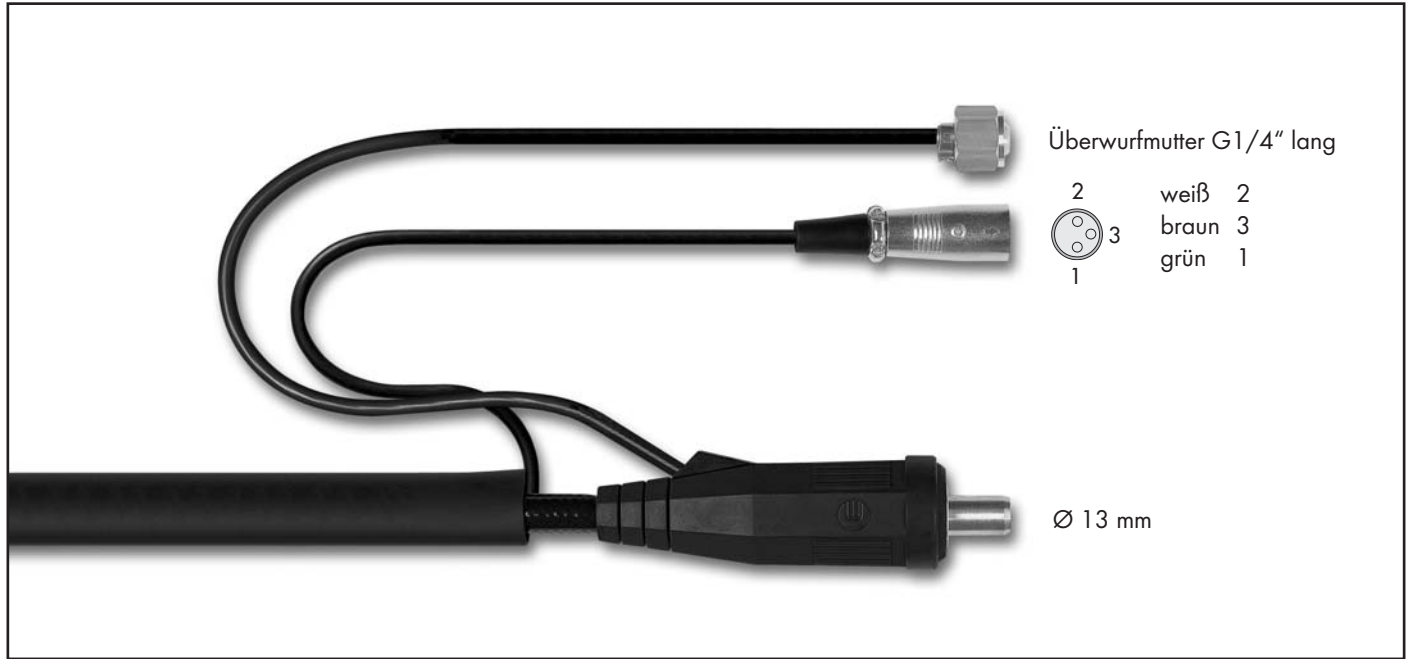

Brennertyp	Länge	Schalterfunktion	maschinenseitiger Anschluss	Schlauchpaketausführung	Bestellnummer
ABITIG® 9	4 m	DD	BSB 35-50 Rundsteckverb. 3-pol.	Standard	7S1SK043520041A51
	8 m	DD	BSB 35-50 Rundsteckverb. 3-pol.	Standard	7S1SK083520041A51
	4 m	DD	BSB 35-50 Rundsteckverb. 3-pol.	High Flex Leder	7S1SH043520041A51
	8 m	DD	BSB 35-50 Rundsteckverb. 3-pol.	High Flex Leder	7S1SH083520041A51
ABITIG® 9 Little	4 m	DD	BSB 35-50 Rundsteckverb. 3-pol.	High Flex Leder	7L1SH043520041A51
	8 m	DD	BSB 35-50 Rundsteckverb. 3-pol.	High Flex Leder	7L1SH083520041A51
ABITIG® 9F	4 m	DD	BSB 35-50 Rundsteckverb. 3-pol.	Standard	7S1FK043520041A51
	8 m	DD	BSB 35-50 Rundsteckverb. 3-pol.	Standard	7S1FK083520041A01
	4 m	DD	BSB 35-50 Rundsteckverb. 3-pol.	High Flex Leder	7S1FH043520041A51
	8 m	DD	BSB 35-50 Rundsteckverb. 3-pol.	High Flex Leder	7S1FH083520041A51
ABITIG® 9F Little	4 m	DD	BSB 35-50 Rundsteckverb. 3-pol.	High Flex Leder	7L1FH043520041A51
	8 m	DD	BSB 35-50 Rundsteckverb. 3-pol.	High Flex Leder	7L1FH083520041A51
ABITIG® 17	4 m	DD	BSB 35-50 Rundsteckverb. 3-pol.	Standard	7S2SK043520041A51
	8 m	DD	BSB 35-50 Rundsteckverb. 3-pol.	Standard	7S2SK083520041A51
	4 m	DD	BSB 35-50 Rundsteckverb. 3-pol.	High Flex Leder	7S2SH043520041A51
	8 m	DD	BSB 35-50 Rundsteckverb. 3-pol.	High Flex Leder	7S2SH083520041A51
ABITIG® 17 Little	4 m	DD	BSB 35-50 Rundsteckverb. 3-pol.	High Flex Leder	7L2SH043520041A51
	8 m	DD	BSB 35-50 Rundsteckverb. 3-pol.	High Flex Leder	7L2SH083520041A51
ABITIG® 17F	4 m	DD	BSB 35-50 Rundsteckverb. 3-pol.	Standard	7S2FK043520041A51
	8 m	DD	BSB 35-50 Rundsteckverb. 3-pol.	Standard	7S2FK083520041A51
	4 m	DD	BSB 35-50 Rundsteckverb. 3-pol.	High Flex Leder	7S2FH043520041A51
	8 m	DD	BSB 35-50 Rundsteckverb. 3-pol.	High Flex Leder	7S2FH083520041A51
ABITIG® 17F Little	4 m	DD	BSB 35-50 Rundsteckverb. 3-pol.	High Flex Leder	7L2FH043520041A51
	8 m	DD	BSB 35-50 Rundsteckverb. 3-pol.	High Flex Leder	7L2FH083520041A51

Technische Änderungen vorbehalten • Verkaufspreise = unverbindliche Preisempfehlung - Angebot freibleibend • © Copyright

ABITIG® GRIP / ABITIG® GRIP Little-Brennerpreisliste

passend für WIG-Stromquellen des Fabrikates „eseti“

Brennertyp	Länge	Schalterfunktion	maschinenseitiger Anschluss	Schlauchpaketausführung	Bestellnummer
ABITIG® 26	4 m	DD	BSB 35-50 Rundsteckverb. 3-pol.	Standard	7S3SK043520041A51
	8 m	DD	BSB 35-50 Rundsteckverb. 3-pol.	Standard	7S3SK083520041A51
	4 m	DD	BSB 35-50 Rundsteckverb. 3-pol.	High Flex Leder	7S3SH043520041A51
	8 m	DD	BSB 35-50 Rundsteckverb. 3-pol.	High Flex Leder	7S3SH083520041A51
ABITIG® 26F	4 m	DD	BSB 35-50 Rundsteckverb. 3-pol.	Standard	7S3FK043520041A51
	8 m	DD	BSB 35-50 Rundsteckverb. 3-pol.	Standard	7S3FK083520041A51
	4 m	DD	BSB 35-50 Rundsteckverb. 3-pol.	High Flex Leder	7S3FH043520041A51
	8 m	DD	BSB 35-50 Rundsteckverb. 3-pol.	High Flex Leder	7S3FH083520041A51
ABITIG® 24G	4 m	DD	BSB 35-50 Rundsteckverb. 3-pol.	Standard	7S8SK043520041A51
	8 m	DD	BSB 35-50 Rundsteckverb. 3-pol.	Standard	7S8SK083520041A51
	4 m	DD	BSB 35-50 Rundsteckverb. 3-pol.	High Flex Leder	7S8SH043520041A51
	8 m	DD	BSB 35-50 Rundsteckverb. 3-pol.	High Flex Leder	7S8SH083520041A51
ABITIG® 24G Little	4 m	DD	BSB 35-50 Rundsteckverb. 3-pol.	High Flex Leder	7L8SH043520041A51
	8 m	DD	BSB 35-50 Rundsteckverb. 3-pol.	High Flex Leder	7L8SH083520041A51
ABITIG® 200	4 m	DD	BSB 35-50 Rundsteckverb. 3-pol.	Standard	7T4SK043520041A51
	8 m	DD	BSB 35-50 Rundsteckverb. 3-pol.	Standard	7T4SK083520041A51
	4 m	DD	BSB 35-50 Rundsteckverb. 3-pol.	High Flex Leder	7T4SH043520041A51
	8 m	DD	BSB 35-50 Rundsteckverb. 3-pol.	High Flex Leder	7T4SH083520041A51
ABITIG® 200F	4 m	DD	BSB 35-50 Rundsteckverb. 3-pol.	Standard	7T4FK043520041A51
	8 m	DD	BSB 35-50 Rundsteckverb. 3-pol.	Standard	7T4FK083520041A51
	4 m	DD	BSB 35-50 Rundsteckverb. 3-pol.	High Flex Leder	7T4FH043520041A51
	8 m	DD	BSB 35-50 Rundsteckverb. 3-pol.	High Flex Leder	7T4FH083520041A51
ABITIG® 150	4 m	DD	BSB 35-50 Rundsteckverb. 3-pol.	Standard	7T6SK043520041A51
	8 m	DD	BSB 35-50 Rundsteckverb. 3-pol.	Standard	7T6SK083520041A51
	4 m	DD	BSB 35-50 Rundsteckverb. 3-pol.	High Flex Leder	7T6SH043520041A51
	8 m	DD	BSB 35-50 Rundsteckverb. 3-pol.	High Flex Leder	7T6SH083520041A51
ABITIG® 150 Little	4 m	DD	BSB 35-50 Rundsteckverb. 3-pol.	High Flex Leder	7L6SH043520041A51
	8 m	DD	BSB 35-50 Rundsteckverb. 3-pol.	High Flex Leder	7L6SH083520041A51
ABITIG® 150F	4 m	DD	BSB 35-50 Rundsteckverb. 3-pol.	Standard	7T6FK043520041A51
	8 m	DD	BSB 35-50 Rundsteckverb. 3-pol.	Standard	7T6FK083520041A51
	4 m	DD	BSB 35-50 Rundsteckverb. 3-pol.	High Flex Leder	7T6FH043520041A51
	8 m	DD	BSB 35-50 Rundsteckverb. 3-pol.	High Flex Leder	7T6FH083520041A51
ABITIG® 150F Little	4 m	DD	BSB 35-50 Rundsteckverb. 3-pol.	High Flex Leder	7L6FH043520041A51
	8 m	DD	BSB 35-50 Rundsteckverb. 3-pol.	High Flex Leder	7L6FH083520041A51

ABITIG® GRIP / ABITIG® GRIP Little-Brennerpreisliste

passend für WIG-Stromquellen des Fabrikates „eseti“

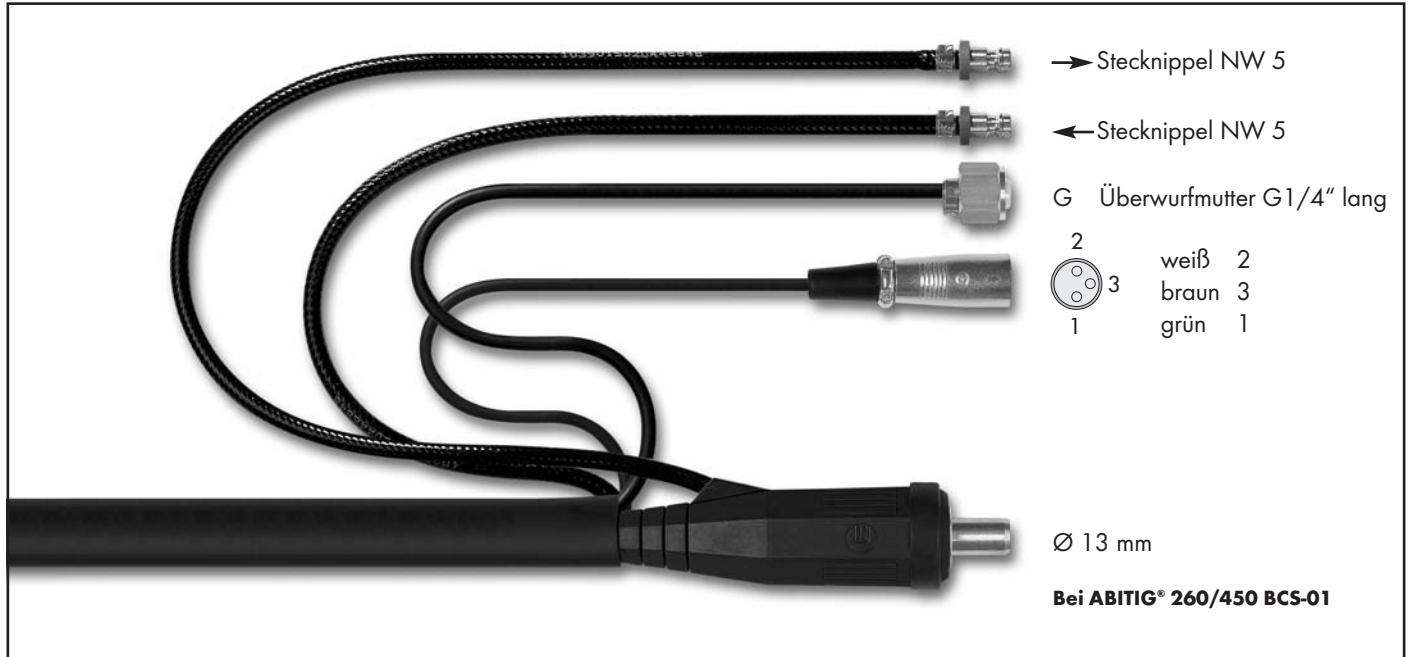

Brennertyp	Länge	Schalterfunktion	maschinenseitiger Anschluss	Schlauchpaketausführung	Bestellnummer
ABITIG® 18	4 m	DD	BSB 35-50 Rundsteckverb. 3-pol.	Standard	7S4SK043520041A81
	8 m	DD	BSB 35-50 Rundsteckverb. 3-pol.	Standard	7S4SK083520041A81
	4 m	DD	BSB 35-50 Rundsteckverb. 3-pol.	High Flex Leder	7S4SH043520041A81
	8 m	DD	BSB 35-50 Rundsteckverb. 3-pol.	High Flex Leder	7S4SH083520041A81
ABITIG® 18F	4 m	DD	BSB 35-50 Rundsteckverb. 3-pol.	Standard	7S4FK043520041A81
	8 m	DD	BSB 35-50 Rundsteckverb. 3-pol.	Standard	7S4FK083520041A81
	4 m	DD	BSB 35-50 Rundsteckverb. 3-pol.	High Flex Leder	7S4FH043520041A81
	8 m	DD	BSB 35-50 Rundsteckverb. 3-pol.	High Flex Leder	7S4FH083520041A81
ABITIG® 20	4 m	DD	BSB 35-50 Rundsteckverb. 3-pol.	Standard	7S5SK043520041A81
	8 m	DD	BSB 35-50 Rundsteckverb. 3-pol.	Standard	7S5SK083520041A81
	4 m	DD	BSB 35-50 Rundsteckverb. 3-pol.	High Flex Leder	7S5SH043520041A81
	8 m	DD	BSB 35-50 Rundsteckverb. 3-pol.	High Flex Leder	7S5SH083520041A81
ABITIG® 20 Little	4 m	DD	BSB 35-50 Rundsteckverb. 3-pol.	High Flex Leder	7L5SH043520041A81
	8 m	DD	BSB 35-50 Rundsteckverb. 3-pol.	High Flex Leder	7L5SH083520041A81
ABITIG® 20F	4 m	DD	BSB 35-50 Rundsteckverb. 3-pol.	Standard	7S5FK043520041A81
	8 m	DD	BSB 35-50 Rundsteckverb. 3-pol.	Standard	7S5FK083520041A81
	4 m	DD	BSB 35-50 Rundsteckverb. 3-pol.	High Flex Leder	7S5FH043520041A81
	8 m	DD	BSB 35-50 Rundsteckverb. 3-pol.	High Flex Leder	7S5FH083520041A81
ABITIG® 20F Little	4 m	DD	BSB 35-50 Rundsteckverb. 3-pol.	High Flex Leder	7L5FH043520041A81
	8 m	DD	BSB 35-50 Rundsteckverb. 3-pol.	High Flex Leder	7L5FH083520041A81

Technische Änderungen vorbehalten • Verkaufspreise = unverbindliche Preisempfehlung - Angebot freibleibend • © Copyright

ABITIG® GRIP / ABITIG® GRIP Little-Brennerpreisliste

passend für WIG-Stromquellen des Fabrikates „esseti“

Brennertyp	Länge	Schalterfunktion	maschinenseitiger Anschluss	Schlauchpaketausführung	Bestellnummer
ABITIG® 12-1	4 m	DD	BSB 35-50 Rundsteckverb. 3-pol.	Standard	7S6SK043520041A81
	8 m	DD	BSB 35-50 Rundsteckverb. 3-pol.	Standard	7S6SK083520041A81
	4 m	DD	BSB 35-50 Rundsteckverb. 3-pol.	High Flex Leder	7S6SH043520041A81
	8 m	DD	BSB 35-50 Rundsteckverb. 3-pol.	High Flex Leder	7S6SH083520041A81
ABITIG® 18SC	4 m	DD	BSB 35-50 Rundsteckverb. 3-pol.	Standard	7S7SK043520041A81
	8 m	DD	BSB 35-50 Rundsteckverb. 3-pol.	Standard	7S7SK083520041A81
	4 m	DD	BSB 35-50 Rundsteckverb. 3-pol.	High Flex Leder	7S7SH043520041A81
	8 m	DD	BSB 35-50 Rundsteckverb. 3-pol.	High Flex Leder	7S7SH083520041A81
ABITIG® 24W	4 m	DD	BSB 35-50 Rundsteckverb. 3-pol.	Standard	7S9SK043520041A81
	8 m	DD	BSB 35-50 Rundsteckverb. 3-pol.	Standard	7S9SK083520041A81
	4 m	DD	BSB 35-50 Rundsteckverb. 3-pol.	High Flex Leder	7S9SH043520041A81
	8 m	DD	BSB 35-50 Rundsteckverb. 3-pol.	High Flex Leder	7S9SH083520041A81
ABITIG® 24W Little	4 m	DD	BSB 35-50 Rundsteckverb. 3-pol.	High Flex Leder	7L9SH043520041A81
	8 m	DD	BSB 35-50 Rundsteckverb. 3-pol.	High Flex Leder	7L9SH083520041A81
ABITIG® 450W	4 m	DD	BSB 35-50 Rundsteckverb. 3-pol.	Standard	7T5SK043520141A81
	8 m	DD	BSB 35-50 Rundsteckverb. 3-pol.	Standard	7T5SK083520141A81
	4 m	DD	BSB 35-50 Rundsteckverb. 3-pol.	High Flex Leder	7T5SH043520141A81
	8 m	DD	BSB 35-50 Rundsteckverb. 3-pol.	High Flex Leder	7T5SH083520141A81
ABITIG® 260W	4 m	DD	BSB 35-50 Rundsteckverb. 3-pol.	Standard	7T7SK043520141A81
	8 m	DD	BSB 35-50 Rundsteckverb. 3-pol.	Standard	7T7SK083520141A81
	4 m	DD	BSB 35-50 Rundsteckverb. 3-pol.	High Flex Leder	7T7SH043520141A81
	8 m	DD	BSB 35-50 Rundsteckverb. 3-pol.	High Flex Leder	7T7SH083520141A81
ABITIG® 260W Little	4 m	DD	BSB 35-50 Rundsteckverb. 3-pol.	High Flex Leder	7L7SH043520141A81
	8 m	DD	BSB 35-50 Rundsteckverb. 3-pol.	High Flex Leder	7L7SH083520141A81
ABITIG® 450W SC	4 m	DD	BSB 35-50 Rundsteckverb. 3-pol.	Standard	
	8 m	DD	BSB 35-50 Rundsteckverb. 3-pol.	Standard	
	4 m	DD	BSB 35-50 Rundsteckverb. 3-pol.	High Flex Leder	7T8SH043520141A81
	8 m	DD	BSB 35-50 Rundsteckverb. 3-pol.	High Flex Leder	7T8SH083520141A81

ABITIG® GRIP / ABITIG® GRIP Little-Brennerpreisliste

passend für WIG-Stromquellen des Fabrikates „ewm“



Brennertyp	Länge	Schalterfunktion	maschinenseitiger Anschluss	Schlauchpaketausführung	Bestellnummer
ABITIG® 9	4 m	DD	BSB 35-50 Tuchel 5-pol.	Standard	7S1SK043520001A01
	8 m	DD	BSB 35-50 Tuchel 5-pol.	Standard	7S1SK083520001A01
	4 m	DD	BSB 35-50 Tuchel 5-pol.	High Flex Leder	7S1SH043520001A01
	8 m	DD	BSB 35-50 Tuchel 5-pol.	High Flex Leder	7S1SH083520001A01
ABITIG® 9 Little	4 m	DD	BSB 35-50 Tuchel 5-pol.	High Flex Leder	7L1SH043520001A01
	8 m	DD	BSB 35-50 Tuchel 5-pol.	High Flex Leder	7L1SH083520001A01
ABITIG® 9F	4 m	DD	BSB 35-50 Tuchel 5-pol.	Standard	7S1FK043520001A01
	8 m	DD	BSB 35-50 Tuchel 5-pol.	Standard	7S1FK083520001A01
	4 m	DD	BSB 35-50 Tuchel 5-pol.	High Flex Leder	7S1FH043520001A01
	8 m	DD	BSB 35-50 Tuchel 5-pol.	High Flex Leder	7S1FH083520001A01
ABITIG® 9F Little	4 m	DD	BSB 35-50 Tuchel 5-pol.	High Flex Leder	7L1FH043520001A01
	8 m	DD	BSB 35-50 Tuchel 5-pol.	High Flex Leder	7L1FH083520001A01
ABITIG® 17	4 m	DD	BSB 35-50 Tuchel 5-pol.	Standard	7S2SK043520001A01
	8 m	DD	BSB 35-50 Tuchel 5-pol.	Standard	7S2SK083520001A01
	4 m	DD	BSB 35-50 Tuchel 5-pol.	High Flex Leder	7S2SH043520001A01
	8 m	DD	BSB 35-50 Tuchel 5-pol.	High Flex Leder	7S2SH083520001A01
ABITIG® 17 Little	4 m	DD	BSB 35-50 Tuchel 5-pol.	High Flex Leder	7L2SH043520001A01
	8 m	DD	BSB 35-50 Tuchel 5-pol.	High Flex Leder	7L2SH083520001A01
ABITIG® 17F	4 m	DD	BSB 35-50 Tuchel 5-pol.	Standard	7S2FK043520001A01
	8 m	DD	BSB 35-50 Tuchel 5-pol.	Standard	7S2FK083520001A01
	4 m	DD	BSB 35-50 Tuchel 5-pol.	High Flex Leder	7S2FH043520001A01
	8 m	DD	BSB 35-50 Tuchel 5-pol.	High Flex Leder	7S2FH083520001A01
ABITIG® 17F Little	4 m	DD	BSB 35-50 Tuchel 5-pol.	High Flex Leder	7L2FH043520001A01
	8 m	DD	BSB 35-50 Tuchel 5-pol.	High Flex Leder	7L2FH083520001A01

Technische Änderungen vorbehalten • Verkaufspreise = unverbindliche Preisempfehlung - Angebot freibleibend • © Copyright

ABITIG® GRIP / ABITIG® GRIP Little-Brennerpreisliste

passend für WIG-Stromquellen des Fabrikates „ewm“

Brennertyp	Länge	Schalterfunktion	maschinenseitiger Anschluss	Schlauchpaketausführung	Bestellnummer
ABITIG® 26	4 m	DD	BSB 35-50 Tuchel 5-pol.	Standard	7S3SK043520001A01
	8 m	DD	BSB 35-50 Tuchel 5-pol.	Standard	7S3SK083520001A01
	4 m	DD	BSB 35-50 Tuchel 5-pol.	High Flex Leder	7S3SH043520001A01
	8 m	DD	BSB 35-50 Tuchel 5-pol.	High Flex Leder	7S3SH083520001A01
ABITIG® 26F	4 m	DD	BSB 35-50 Tuchel 5-pol.	Standard	7S3FK043520001A01
	8 m	DD	BSB 35-50 Tuchel 5-pol.	Standard	7S3FK083520001A01
	4 m	DD	BSB 35-50 Tuchel 5-pol.	High Flex Leder	7S3FH043520001A01
	8 m	DD	BSB 35-50 Tuchel 5-pol.	High Flex Leder	7S3FH083520001A01
ABITIG® 24G	4 m	DD	BSB 35-50 Tuchel 5-pol.	Standard	7S8SK043520001A01
	8 m	DD	BSB 35-50 Tuchel 5-pol.	Standard	7S8SK083520001A01
	4 m	DD	BSB 35-50 Tuchel 5-pol.	High Flex Leder	7S8SH043520001A01
	8 m	DD	BSB 35-50 Tuchel 5-pol.	High Flex Leder	7S8SH083520001A01
ABITIG® 24G Little	4 m	DD	BSB 35-50 Tuchel 5-pol.	High Flex Leder	7L8SH043520001A01
	8 m	DD	BSB 35-50 Tuchel 5-pol.	High Flex Leder	7L8SH083520001A01
ABITIG® 200	4 m	DD	BSB 35-50 Tuchel 5-pol.	Standard	7T4SK043520001A01
	8 m	DD	BSB 35-50 Tuchel 5-pol.	Standard	7T4SK083520001A01
	4 m	DD	BSB 35-50 Tuchel 5-pol.	High Flex Leder	7T4SH043520001A01
	8 m	DD	BSB 35-50 Tuchel 5-pol.	High Flex Leder	7T4SH083520001A01
ABITIG® 200F	4 m	DD	BSB 35-50 Tuchel 5-pol.	Standard	7T4FK043520001A01
	8 m	DD	BSB 35-50 Tuchel 5-pol.	Standard	7T4FK083520001A01
	4 m	DD	BSB 35-50 Tuchel 5-pol.	High Flex Leder	7T4FH043520001A01
	8 m	DD	BSB 35-50 Tuchel 5-pol.	High Flex Leder	7T4FH083520001A01
ABITIG® 150	4 m	DD	BSB 35-50 Tuchel 5-pol.	Standard	7T6SK043520001A01
	8 m	DD	BSB 35-50 Tuchel 5-pol.	Standard	7T6SK083520001A01
	4 m	DD	BSB 35-50 Tuchel 5-pol.	High Flex Leder	7T6SH043520001A01
	8 m	DD	BSB 35-50 Tuchel 5-pol.	High Flex Leder	7T6SH083520001A01
ABITIG® 150 Little	4 m	DD	BSB 35-50 Tuchel 5-pol.	High Flex Leder	7L6SH043520001A01
	8 m	DD	BSB 35-50 Tuchel 5-pol.	High Flex Leder	7L6SH083520001A01
ABITIG® 150F	4 m	DD	BSB 35-50 Tuchel 5-pol.	Standard	7T6FK043520001A01
	8 m	DD	BSB 35-50 Tuchel 5-pol.	Standard	7T6FK083520001A01
	4 m	DD	BSB 35-50 Tuchel 5-pol.	High Flex Leder	7T6FH043520001A01
	8 m	DD	BSB 35-50 Tuchel 5-pol.	High Flex Leder	7T6FH083520001A01
ABITIG® 150F Little	4 m	DD	BSB 35-50 Tuchel 5-pol.	High Flex Leder	7L6FH043520001A01
	8 m	DD	BSB 35-50 Tuchel 5-pol.	High Flex Leder	7L6FH083520001A01

ABITIG® GRIP / ABITIG® GRIP Little-Brennerpreisliste

passend für WIG-Stromquellen des Fabrikates „ewm“



Brennertyp	Länge	Schalterfunktion	maschinenseitiger Anschluss	Schlauchpaketausführung	Bestellnummer
ABITIG® 9	4 m	DD	ZA - GZ Tuchel 5-pol.	Standard	7S1SK043520301A00
	8 m	DD	ZA - GZ Tuchel 5-pol.	Standard	7S1SK083520301A00
	4 m	DD	ZA - GZ Tuchel 5-pol.	High Flex Leder	7S1SH043520301A00
	8 m	DD	ZA - GZ Tuchel 5-pol.	High Flex Leder	7S1SH083520301A00
ABITIG® 9 Little	4 m	DD	ZA - GZ Tuchel 5-pol.	High Flex Leder	7L1SH043520301A00
	8 m	DD	ZA - GZ Tuchel 5-pol.	High Flex Leder	7L1SH083520301A00
ABITIG® 9F	4 m	DD	ZA - GZ Tuchel 5-pol.	Standard	7S1FK043520301A00
	8 m	DD	ZA - GZ Tuchel 5-pol.	Standard	7S1FK083520301A00
	4 m	DD	ZA - GZ Tuchel 5-pol.	High Flex Leder	7S1FH043520301A00
	8 m	DD	ZA - GZ Tuchel 5-pol.	High Flex Leder	7S1FH083520301A00
ABITIG® 9F Little	4 m	DD	ZA - GZ Tuchel 5-pol.	High Flex Leder	7L1FH043520301A00
	8 m	DD	ZA - GZ Tuchel 5-pol.	High Flex Leder	7L1FH083520301A00
ABITIG® 17	4 m	DD	ZA - GZ Tuchel 5-pol.	Standard	7S2SK043520301A00
	8 m	DD	ZA - GZ Tuchel 5-pol.	Standard	7S2SK083520301A00
	4 m	DD	ZA - GZ Tuchel 5-pol.	High Flex Leder	7S2SH043520301A00
	8 m	DD	ZA - GZ Tuchel 5-pol.	High Flex Leder	7S2SH083520301A00
ABITIG® 17 Little	4 m	DD	ZA - GZ Tuchel 5-pol.	High Flex Leder	7L2SH043520301A00
	8 m	DD	ZA - GZ Tuchel 5-pol.	High Flex Leder	7L2SH083520301A00
ABITIG® 17F	4 m	DD	ZA - GZ Tuchel 5-pol.	Standard	7S2FK043520301A00
	8 m	DD	ZA - GZ Tuchel 5-pol.	Standard	7S2FK083520301A00
	4 m	DD	ZA - GZ Tuchel 5-pol.	High Flex Leder	7S2FH043520301A00
	8 m	DD	ZA - GZ Tuchel 5-pol.	High Flex Leder	7S2FH083520301A00
ABITIG® 17F Little	4 m	DD	ZA - GZ Tuchel 5-pol.	High Flex Leder	7L2FH043520301A00
	8 m	DD	ZA - GZ Tuchel 5-pol.	High Flex Leder	7L2FH083520301A00

Technische Änderungen vorbehalten • Verkaufspreise = unverbindliche Preisempfehlung - Angebot freibleibend • © Copyright

ABITIG® GRIP / ABITIG® GRIP Little-Brennerpreisliste

passend für WIG-Stromquellen des Fabrikates „ewm“

Brennertyp	Länge	Schalterfunktion	maschinenseitiger Anschluss	Schlauchpaketausführung	Bestellnummer
ABITIG® 26	4 m	DD	ZA - GZ Tuchel 5-pol.	Standard	7S3SK043520301A00
	8 m	DD	ZA - GZ Tuchel 5-pol.	Standard	7S3SK083520301A00
	4 m	DD	ZA - GZ Tuchel 5-pol.	High Flex Leder	7S3SH043520301A00
	8 m	DD	ZA - GZ Tuchel 5-pol.	High Flex Leder	7S3SH083520301A00
ABITIG® 26F	4 m	DD	ZA - GZ Tuchel 5-pol.	Standard	7S3FK043520301A00
	8 m	DD	ZA - GZ Tuchel 5-pol.	Standard	7S3FK083520301A00
	4 m	DD	ZA - GZ Tuchel 5-pol.	High Flex Leder	7S3FH043520301A00
	8 m	DD	ZA - GZ Tuchel 5-pol.	High Flex Leder	7S3FH083520301A00
ABITIG® 24G	4 m	DD	ZA - GZ Tuchel 5-pol.	Standard	7S8SK043520301A00
	8 m	DD	ZA - GZ Tuchel 5-pol.	Standard	7S8SK083520301A00
	4 m	DD	ZA - GZ Tuchel 5-pol.	High Flex Leder	7S8SH043520301A00
	8 m	DD	ZA - GZ Tuchel 5-pol.	High Flex Leder	7S8SH083520301A00
ABITIG® 24G Little	4 m	DD	ZA - GZ Tuchel 5-pol.	High Flex Leder	7L8SH043520301A00
	8 m	DD	ZA - GZ Tuchel 5-pol.	High Flex Leder	7L8SH083520301A00
ABITIG® 200	4 m	DD	ZA - GZ Tuchel 5-pol.	Standard	7T4SK043520301A00
	8 m	DD	ZA - GZ Tuchel 5-pol.	Standard	7T4SK083520301A00
	4 m	DD	ZA - GZ Tuchel 5-pol.	High Flex Leder	7T4SH043520301A00
	8 m	DD	ZA - GZ Tuchel 5-pol.	High Flex Leder	7T4SH083520301A00
ABITIG® 200F	4 m	DD	ZA - GZ Tuchel 5-pol.	Standard	7T4FK043520301A00
	8 m	DD	ZA - GZ Tuchel 5-pol.	Standard	7T4FK083520301A00
	4 m	DD	ZA - GZ Tuchel 5-pol.	High Flex Leder	7T4FH043520301A00
	8 m	DD	ZA - GZ Tuchel 5-pol.	High Flex Leder	7T4FH083520301A00
ABITIG® 150	4 m	DD	ZA - GZ Tuchel 5-pol.	Standard	7T6SK043520301A00
	8 m	DD	ZA - GZ Tuchel 5-pol.	Standard	7T6SK083520301A00
	4 m	DD	ZA - GZ Tuchel 5-pol.	High Flex Leder	7T6SH043520301A00
	8 m	DD	ZA - GZ Tuchel 5-pol.	High Flex Leder	7T6SH083520301A00
ABITIG® 150 Little	4 m	DD	ZA - GZ Tuchel 5-pol.	High Flex Leder	7L6SH043520301A00
	8 m	DD	ZA - GZ Tuchel 5-pol.	High Flex Leder	7L6SH083520301A00
ABITIG® 150F	4 m	DD	ZA - GZ Tuchel 5-pol.	Standard	7T6FK043520301A00
	8 m	DD	ZA - GZ Tuchel 5-pol.	Standard	7T6FK083520301A00
	4 m	DD	ZA - GZ Tuchel 5-pol.	High Flex Leder	7T6FH043520301A00
	8 m	DD	ZA - GZ Tuchel 5-pol.	High Flex Leder	7T6FH083520301A00
ABITIG® 150F Little	4 m	DD	ZA - GZ Tuchel 5-pol.	High Flex Leder	7L6FH043520301A00
	8 m	DD	ZA - GZ Tuchel 5-pol.	High Flex Leder	7L6FH083520301A00

ABITIG® GRIP / ABITIG® GRIP Little-Brennerpreisliste

passend für WIG-Stromquellen des Fabrikates „ewm“



Brennertyp	Länge	Schalterfunktion	maschinenseitiger Anschluss	Schlauchpaketausführung	Bestellnummer
ABITIG® 9	4 m	DDP	BSB 35-50 Burndy 8-pol.	Standard	7S1SK046540028A01
	8 m	DDP	BSB 35-50 Burndy 8-pol.	Standard	7S1SK086540028A01
	4 m	DDP	BSB 35-50 Burndy 8-pol.	High Flex Leder	7S1SH046540028A01
	8 m	DDP	BSB 35-50 Burndy 8-pol.	High Flex Leder	7S1SH086540028A01
ABITIG® 9F	4 m	DDP	BSB 35-50 Burndy 8-pol.	Standard	7S1FK046540028A01
	8 m	DDP	BSB 35-50 Burndy 8-pol.	Standard	7S1FK086540028A01
	4 m	DDP	BSB 35-50 Burndy 8-pol.	High Flex Leder	7S1FH046540028A01
	8 m	DDP	BSB 35-50 Burndy 8-pol.	High Flex Leder	7S1FH086540028A01
ABITIG® 17	4 m	DDP	BSB 35-50 Burndy 8-pol.	Standard	7S2SK046540028A01
	8 m	DDP	BSB 35-50 Burndy 8-pol.	Standard	7S2SK086540028A01
	4 m	DDP	BSB 35-50 Burndy 8-pol.	High Flex Leder	7S2SH046540028A01
	8 m	DDP	BSB 35-50 Burndy 8-pol.	High Flex Leder	7S2SH086540028A01
ABITIG® 17F	4 m	DDP	BSB 35-50 Burndy 8-pol.	Standard	7S2FK046540028A01
	8 m	DDP	BSB 35-50 Burndy 8-pol.	Standard	7S2FK086540028A01
	4 m	DDP	BSB 35-50 Burndy 8-pol.	High Flex Leder	7S2FH046540028A01
	8 m	DDP	BSB 35-50 Burndy 8-pol.	High Flex Leder	7S2FH086540028A01

Technische Änderungen vorbehalten • Verkaufspreise = unverbindliche Preisempfehlung - Angebot freibleibend • © Copyright

ABITIG® GRIP / ABITIG® GRIP Little-Brennerpreisliste

passend für WIG-Stromquellen des Fabrikates „ewm“

Brennertyp	Länge	Schalterfunktion	maschinenseitiger Anschluss	Schlauchpaketausführung	Bestellnummer
ABITIG® 26	4 m	DDP	BSB 35-50 Burndy 8-pol.	Standard	7S3SK046540028A01
	8 m	DDP	BSB 35-50 Burndy 8-pol.	Standard	7S3SK086540028A01
	4 m	DDP	BSB 35-50 Burndy 8-pol.	High Flex Leder	7S3SH046540028A01
	8 m	DDP	BSB 35-50 Burndy 8-pol.	High Flex Leder	7S3SH086540028A01
ABITIG® 26F	4 m	DDP	BSB 35-50 Burndy 8-pol.	Standard	7S3FK046540028A01
	8 m	DDP	BSB 35-50 Burndy 8-pol.	Standard	7S3FK086540028A01
	4 m	DDP	BSB 35-50 Burndy 8-pol.	High Flex Leder	7S3FH046540028A01
	8 m	DDP	BSB 35-50 Burndy 8-pol.	High Flex Leder	7S3FH086540028A01
ABITIG® 24G	4 m	DDP	BSB 35-50 Burndy 8-pol.	Standard	7S8SK046540028A01
	8 m	DDP	BSB 35-50 Burndy 8-pol.	Standard	7S8SK086540028A01
	4 m	DDP	BSB 35-50 Burndy 8-pol.	High Flex Leder	7S8SH046540028A01
	8 m	DDP	BSB 35-50 Burndy 8-pol.	High Flex Leder	7S8SH086540028A01
ABITIG® 200	4 m	DDP	BSB 35-50 Burndy 8-pol.	Standard	7T4SK046540028A01
	8 m	DDP	BSB 35-50 Burndy 8-pol.	Standard	7T4SK086540028A01
	4 m	DDP	BSB 35-50 Burndy 8-pol.	High Flex Leder	7T4SH046540028A01
	8 m	DDP	BSB 35-50 Burndy 8-pol.	High Flex Leder	7T4SH086540028A01
ABITIG® 200F	4 m	DDP	BSB 35-50 Burndy 8-pol.	Standard	7T4FK046540028A01
	8 m	DDP	BSB 35-50 Burndy 8-pol.	Standard	7T4FK086540028A01
	4 m	DDP	BSB 35-50 Burndy 8-pol.	High Flex Leder	7T4FH046540028A01
	8 m	DDP	BSB 35-50 Burndy 8-pol.	High Flex Leder	7T4FH086540028A01
ABITIG® 150	4 m	DDP	BSB 35-50 Burndy 8-pol.	Standard	7T6SK046540028A01
	8 m	DDP	BSB 35-50 Burndy 8-pol.	Standard	7T6SK086540028A01
	4 m	DDP	BSB 35-50 Burndy 8-pol.	High Flex Leder	7T6SH046540028A01
	8 m	DDP	BSB 35-50 Burndy 8-pol.	High Flex Leder	7T6SH086540028A01
ABITIG® 150F	4 m	DDP	BSB 35-50 Burndy 8-pol.	Standard	7T6FK046540028A01
	8 m	DDP	BSB 35-50 Burndy 8-pol.	Standard	7T6FK086540028A01
	4 m	DDP	BSB 35-50 Burndy 8-pol.	High Flex Leder	7T6FH046540028A01
	8 m	DDP	BSB 35-50 Burndy 8-pol.	High Flex Leder	7T6FH086540028A01

ABITIG® GRIP / ABITIG® GRIP Little-Brennerpreisliste

passend für WIG-Stromquellen des Fabrikates „ewm“



Brennertyp	Länge	Schalterfunktion	maschinenseitiger Anschluss	Schlauchpaketausführung	Bestellnummer
ABITIG® 9	4 m	DDP	BSB 35-50 Tuchel 5-pol. + AMP 14-pol.	Standard	7S1SK046540023A01
	8 m	DDP	BSB 35-50 Tuchel 5-pol. + AMP 14-pol.	Standard	7S1SK086540023A01
	4 m	DDP	BSB 35-50 Tuchel 5-pol. + AMP 14-pol.	High Flex Leder	7S1SH046540023A01
	8 m	DDP	BSB 35-50 Tuchel 5-pol. + AMP 14-pol.	High Flex Leder	7S1SH086540023A01
ABITIG® 9F	4 m	DDP	BSB 35-50 Tuchel 5-pol. + AMP 14-pol.	Standard	7S1FK046540023A01
	8 m	DDP	BSB 35-50 Tuchel 5-pol. + AMP 14-pol.	Standard	7S1FK086540023A01
	4 m	DDP	BSB 35-50 Tuchel 5-pol. + AMP 14-pol.	High Flex Leder	7S1FH046540023A01
	8 m	DDP	BSB 35-50 Tuchel 5-pol. + AMP 14-pol.	High Flex Leder	7S1FH086540023A01
ABITIG® 17	4 m	DDP	BSB 35-50 Tuchel 5-pol. + AMP 14-pol.	Standard	7S2SK046540023A01
	8 m	DDP	BSB 35-50 Tuchel 5-pol. + AMP 14-pol.	Standard	7S2SK086540023A01
	4 m	DDP	BSB 35-50 Tuchel 5-pol. + AMP 14-pol.	High Flex Leder	7S2SH046540023A01
	8 m	DDP	BSB 35-50 Tuchel 5-pol. + AMP 14-pol.	High Flex Leder	7S2SH086540023A01
ABITIG® 17F	4 m	DDP	BSB 35-50 Tuchel 5-pol. + AMP 14-pol.	Standard	7S2FK046540023A01
	8 m	DDP	BSB 35-50 Tuchel 5-pol. + AMP 14-pol.	Standard	7S2FK086540023A01
	4 m	DDP	BSB 35-50 Tuchel 5-pol. + AMP 14-pol.	High Flex Leder	7S2FH046540023A01
	8 m	DDP	BSB 35-50 Tuchel 5-pol. + AMP 14-pol.	High Flex Leder	7S2FH086540023A01

Technische Änderungen vorbehalten • Verkaufspreise = unverbindliche Preisempfehlung - Angebot freibleibend • © Copyright

ABITIG® GRIP / ABITIG® GRIP Little-Brennerpreisliste

passend für WIG-Stromquellen des Fabrikates „ewm“

Brennertyp	Länge	Schalterfunktion	maschinenseitiger Anschluss	Schlauchpaketausführung	Bestellnummer
ABITIG® 26	4 m	DDP	BSB 35-50 Tuchel 5-pol. + AMP 14-pol.	Standard	7S3SK046540023A01
	8 m	DDP	BSB 35-50 Tuchel 5-pol. + AMP 14-pol.	Standard	7S3SK086540023A01
	4 m	DDP	BSB 35-50 Tuchel 5-pol. + AMP 14-pol.	High Flex Leder	7S3SH046540023A01
	8 m	DDP	BSB 35-50 Tuchel 5-pol. + AMP 14-pol.	High Flex Leder	7S3SH086540023A01
ABITIG® 26F	4 m	DDP	BSB 35-50 Tuchel 5-pol. + AMP 14-pol.	Standard	7S3FK046540023A01
	8 m	DDP	BSB 35-50 Tuchel 5-pol. + AMP 14-pol.	Standard	7S3FK086540023A01
	4 m	DDP	BSB 35-50 Tuchel 5-pol. + AMP 14-pol.	High Flex Leder	7S3FH046540023A01
	8 m	DDP	BSB 35-50 Tuchel 5-pol. + AMP 14-pol.	High Flex Leder	7S3FH086540023A01
ABITIG® 24G	4 m	DDP	BSB 35-50 Tuchel 5-pol. + AMP 14-pol.	Standard	7S8SK046540023A01
	8 m	DDP	BSB 35-50 Tuchel 5-pol. + AMP 14-pol.	Standard	7S8SK086540023A01
	4 m	DDP	BSB 35-50 Tuchel 5-pol. + AMP 14-pol.	High Flex Leder	7S8SH046540023A01
	8 m	DDP	BSB 35-50 Tuchel 5-pol. + AMP 14-pol.	High Flex Leder	7S8SH086540023A01
ABITIG® 200	4 m	DDP	BSB 35-50 Tuchel 5-pol. + AMP 14-pol.	Standard	7T4SK046540023A01
	8 m	DDP	BSB 35-50 Tuchel 5-pol. + AMP 14-pol.	Standard	7T4SK086540023A01
	4 m	DDP	BSB 35-50 Tuchel 5-pol. + AMP 14-pol.	High Flex Leder	7T4SH046540023A01
	8 m	DDP	BSB 35-50 Tuchel 5-pol. + AMP 14-pol.	High Flex Leder	7T4SH086540023A01
ABITIG® 200F	4 m	DDP	BSB 35-50 Tuchel 5-pol. + AMP 14-pol.	Standard	7T4FK046540023A01
	8 m	DDP	BSB 35-50 Tuchel 5-pol. + AMP 14-pol.	Standard	7T4FK086540023A01
	4 m	DDP	BSB 35-50 Tuchel 5-pol. + AMP 14-pol.	High Flex Leder	7T4FH046540023A01
	8 m	DDP	BSB 35-50 Tuchel 5-pol. + AMP 14-pol.	High Flex Leder	7T4FH086540023A01
ABITIG® 150	4 m	DDP	BSB 35-50 Tuchel 5-pol. + AMP 14-pol.	Standard	7T6SK046540023A01
	8 m	DDP	BSB 35-50 Tuchel 5-pol. + AMP 14-pol.	Standard	7T6SK086540023A01
	4 m	DDP	BSB 35-50 Tuchel 5-pol. + AMP 14-pol.	High Flex Leder	7T6SH046540023A01
	8 m	DDP	BSB 35-50 Tuchel 5-pol. + AMP 14-pol.	High Flex Leder	7T6SH086540023A01
ABITIG® 150F	4 m	DDP	BSB 35-50 Tuchel 5-pol. + AMP 14-pol.	Standard	7T6FK046540023A01
	8 m	DDP	BSB 35-50 Tuchel 5-pol. + AMP 14-pol.	Standard	7T6FK086540023A01
	4 m	DDP	BSB 35-50 Tuchel 5-pol. + AMP 14-pol.	High Flex Leder	7T6FH046540023A01
	8 m	DDP	BSB 35-50 Tuchel 5-pol. + AMP 14-pol.	High Flex Leder	7T6FH086540023A01

ABITIG® GRIP / ABITIG® GRIP Little-Brennerpreisliste

passend für WIG-Stromquellen des Fabrikates „ewm“ Up/Down



Brennertyp	Länge	Schalterfunktion	maschinenseitiger Anschluss	Schlauchpaketausführung	Bestellnummer
ABITIG® 9	4 m	UD	BSB 35-50 Burndy 8-pol.	Standard	7S1SK046650037B01
	8 m	UD	BSB 35-50 Burndy 8-pol.	Standard	7S1SK086650037B01
	4 m	UD	BSB 35-50 Burndy 8-pol.	High Flex Leder	7S1SH046650037B01
	8 m	UD	BSB 35-50 Burndy 8-pol.	High Flex Leder	7S1SH086650037B01
ABITIG® 9 Little	4 m	UD	BSB 35-50 Burndy 8-pol.	High Flex Leder	7L1SH046650037B01
	8 m	UD	BSB 35-50 Burndy 8-pol.	High Flex Leder	7L1SH086650037B01
ABITIG® 9F	4 m	UD	BSB 35-50 Burndy 8-pol.	Standard	7S1FK046650037B01
	8 m	UD	BSB 35-50 Burndy 8-pol.	Standard	7S1FK086650037B01
	4 m	UD	BSB 35-50 Burndy 8-pol.	High Flex Leder	7S1FH046650037B01
	8 m	UD	BSB 35-50 Burndy 8-pol.	High Flex Leder	7S1FH086650037B01
ABITIG® 9F Little	4 m	UD	BSB 35-50 Burndy 8-pol.	High Flex Leder	7L1FH046650037B01
	8 m	UD	BSB 35-50 Burndy 8-pol.	High Flex Leder	7L1FH086650037B01
ABITIG® 17	4 m	UD	BSB 35-50 Burndy 8-pol.	Standard	7S2SK046650037B01
	8 m	UD	BSB 35-50 Burndy 8-pol.	Standard	7S2SK086650037B01
	4 m	UD	BSB 35-50 Burndy 8-pol.	High Flex Leder	7S2SH046650037B01
	8 m	UD	BSB 35-50 Burndy 8-pol.	High Flex Leder	7S2SH086650037B01
ABITIG® 17 Little	4 m	UD	BSB 35-50 Burndy 8-pol.	High Flex Leder	7L2SH046650037B01
	8 m	UD	BSB 35-50 Burndy 8-pol.	High Flex Leder	7L2SH086650037B01
ABITIG® 17F	4 m	UD	BSB 35-50 Burndy 8-pol.	Standard	7S2FK046650037B01
	8 m	UD	BSB 35-50 Burndy 8-pol.	Standard	7S2FK086650037B01
	4 m	UD	BSB 35-50 Burndy 8-pol.	High Flex Leder	7S2FH046650037B01
	8 m	UD	BSB 35-50 Burndy 8-pol.	High Flex Leder	7S2FH086650037B01
ABITIG® 17F Little	4 m	UD	BSB 35-50 Burndy 8-pol.	High Flex Leder	7L2FH046650037B01
	8 m	UD	BSB 35-50 Burndy 8-pol.	High Flex Leder	7L2FH086650037B01

Technische Änderungen vorbehalten • Verkaufspreise = unverbindliche Preisempfehlung - Angebot freibleibend • © Copyright

ABITIG® GRIP / ABITIG® GRIP Little-Brennerpreisliste

passend für WIG-Stromquellen des Fabrikates „ewm“ Up/Down

Brennertyp	Länge	Schalterfunktion	maschinenseitiger Anschluss	Schlauchpaketausführung	Bestellnummer
ABITIG® 26	4 m	UD	BSB 35-50 Burndy 8-pol.	Standard	7S3SK046650037B01
	8 m	UD	BSB 35-50 Burndy 8-pol.	Standard	7S3SK086650037B01
	4 m	UD	BSB 35-50 Burndy 8-pol.	High Flex Leder	7S3SH046650037B01
	8 m	UD	BSB 35-50 Burndy 8-pol.	High Flex Leder	7S3SH086650037B01
ABITIG® 26F	4 m	UD	BSB 35-50 Burndy 8-pol.	Standard	7S3FK046650037B01
	8 m	UD	BSB 35-50 Burndy 8-pol.	Standard	7S3FK086650037B01
	4 m	UD	BSB 35-50 Burndy 8-pol.	High Flex Leder	7S3FH046650037B01
	8 m	UD	BSB 35-50 Burndy 8-pol.	High Flex Leder	7S3FH086650037B01
ABITIG® 24G	4 m	UD	BSB 35-50 Burndy 8-pol.	Standard	7S8SK046650037B01
	8 m	UD	BSB 35-50 Burndy 8-pol.	Standard	7S8SK086650037B01
	4 m	UD	BSB 35-50 Burndy 8-pol.	High Flex Leder	7S8SH046650037B01
	8 m	UD	BSB 35-50 Burndy 8-pol.	High Flex Leder	7S8SH086650037B01
ABITIG® 24G Little	4 m	UD	BSB 35-50 Burndy 8-pol.	High Flex Leder	7L8SH046650037B01
	8 m	UD	BSB 35-50 Burndy 8-pol.	High Flex Leder	7L8SH086650037B01
ABITIG® 200	4 m	UD	BSB 35-50 Burndy 8-pol.	Standard	7T4SK046650037B01
	8 m	UD	BSB 35-50 Burndy 8-pol.	Standard	7T4SK086650037B01
	4 m	UD	BSB 35-50 Burndy 8-pol.	High Flex Leder	7T4SH046650037B01
	8 m	UD	BSB 35-50 Burndy 8-pol.	High Flex Leder	7T4SH086650037B01
ABITIG® 200F	4 m	UD	BSB 35-50 Burndy 8-pol.	Standard	7T4FK046650037B01
	8 m	UD	BSB 35-50 Burndy 8-pol.	Standard	7T4FK086650037B01
	4 m	UD	BSB 35-50 Burndy 8-pol.	High Flex Leder	7T4FH046650037B01
	8 m	UD	BSB 35-50 Burndy 8-pol.	High Flex Leder	7T4FH086650037B01
ABITIG® 150	4 m	UD	BSB 35-50 Burndy 8-pol.	Standard	7T6SK046650037B01
	8 m	UD	BSB 35-50 Burndy 8-pol.	Standard	7T6SK086650037B01
	4 m	UD	BSB 35-50 Burndy 8-pol.	High Flex Leder	7T6SH046650037B01
	8 m	UD	BSB 35-50 Burndy 8-pol.	High Flex Leder	7T6SH086650037B01
ABITIG® 150 Little	4 m	UD	BSB 35-50 Burndy 8-pol.	High Flex Leder	7L6SH046650037B01
	8 m	UD	BSB 35-50 Burndy 8-pol.	High Flex Leder	7L6SH086650037B01
ABITIG® 150F	4 m	UD	BSB 35-50 Burndy 8-pol.	Standard	7T6FK046650037B01
	8 m	UD	BSB 35-50 Burndy 8-pol.	Standard	7T6FK086650037B01
	4 m	UD	BSB 35-50 Burndy 8-pol.	High Flex Leder	7T6FH046650037B01
	8 m	UD	BSB 35-50 Burndy 8-pol.	High Flex Leder	7T6FH086650037B01
ABITIG® 150F Little	4 m	UD	BSB 35-50 Burndy 8-pol.	High Flex Leder	7L6FH046650037B01
	8 m	UD	BSB 35-50 Burndy 8-pol.	High Flex Leder	7L6FH086650037B01

ABITIG® GRIP / ABITIG® GRIP Little-Brennerpreisliste

passend für WIG-Stromquellen des Fabrikates „ewm“



Brennertyp	Länge	Schalterfunktion	maschinenseitiger Anschluss	Schlauchpaketausführung	Bestellnummer
ABITIG® 18	4 m	DD	BSB 35-50 Tuchel 5-pol.	Standard	7S4SK043520001A11
	8 m	DD	BSB 35-50 Tuchel 5-pol.	Standard	7S4SK083520001A11
	4 m	DD	BSB 35-50 Tuchel 5-pol.	High Flex Leder	7S4SH043520001A11
	8 m	DD	BSB 35-50 Tuchel 5-pol.	High Flex Leder	7S4SH083520001A11
ABITIG® 18F	4 m	DD	BSB 35-50 Tuchel 5-pol.	Standard	7S4FK043520001A11
	8 m	DD	BSB 35-50 Tuchel 5-pol.	Standard	7S4FK083520001A11
	4 m	DD	BSB 35-50 Tuchel 5-pol.	High Flex Leder	7S4FH043520001A11
	8 m	DD	BSB 35-50 Tuchel 5-pol.	High Flex Leder	7S4FH083520001A11
ABITIG® 20	4 m	DD	BSB 35-50 Tuchel 5-pol.	Standard	7S5SK043520001A11
	8 m	DD	BSB 35-50 Tuchel 5-pol.	Standard	7S5SK083520001A11
	4 m	DD	BSB 35-50 Tuchel 5-pol.	High Flex Leder	7S5SH043520001A11
	8 m	DD	BSB 35-50 Tuchel 5-pol.	High Flex Leder	7S5SH083520001A11
ABITIG® 20 Little	4 m	DD	BSB 35-50 Tuchel 5-pol.	High Flex Leder	7L5SH043520001A11
	8 m	DD	BSB 35-50 Tuchel 5-pol.	High Flex Leder	7L5SH083520001A11
ABITIG® 20F	4 m	DD	BSB 35-50 Tuchel 5-pol.	Standard	7S5FK043520001A11
	8 m	DD	BSB 35-50 Tuchel 5-pol.	Standard	7S5FK083520001A11
	4 m	DD	BSB 35-50 Tuchel 5-pol.	High Flex Leder	7S5FH043520001A11
	8 m	DD	BSB 35-50 Tuchel 5-pol.	High Flex Leder	7S5FH083520001A11
ABITIG® 20F Little	4 m	DD	BSB 35-50 Tuchel 5-pol.	High Flex Leder	7L5FH043520001A11
	8 m	DD	BSB 35-50 Tuchel 5-pol.	High Flex Leder	7L5FH083520001A11

Technische Änderungen vorbehalten • Verkaufspreise = unverbindliche Preisempfehlung - Angebot freibleibend • © Copyright

ABITIG® GRIP / ABITIG® GRIP Little-Brennerpreisliste

passend für WIG-Stromquellen des Fabrikates „ewm“

Brennertyp	Länge	Schalterfunktion	maschinenseitiger Anschluss	Schlauchpaketausführung	Bestellnummer
ABITIG® 12-1,	4 m	DD	BSB 35-50 Tuchel 5-pol.	Standard	7S6SK043520001A11
	8 m	DD	BSB 35-50 Tuchel 5-pol.	Standard	7S6SK083520001A11
	4 m	DD	BSB 35-50 Tuchel 5-pol.	High Flex Leder	7S6SH043520001A11
	8 m	DD	BSB 35-50 Tuchel 5-pol.	High Flex Leder	7S6SH083520001A11
<hr/>					
ABITIG® 18SC	4 m	DD	BSB 35-50 Tuchel 5-pol.	Standard	7S7SK043520001A11
	8 m	DD	BSB 35-50 Tuchel 5-pol.	Standard	7S7SK083520001A11
	4 m	DD	BSB 35-50 Tuchel 5-pol.	High Flex Leder	7S7SH043520001A11
	8 m	DD	BSB 35-50 Tuchel 5-pol.	High Flex Leder	7S7SH083520001A11
<hr/>					
ABITIG® 24W	4 m	DD	BSB 35-50 Tuchel 5-pol.	Standard	7S9SK043520001A11
	8 m	DD	BSB 35-50 Tuchel 5-pol.	Standard	7S9SK083520001A11
	4 m	DD	BSB 35-50 Tuchel 5-pol.	High Flex Leder	7S9SH043520001A11
	8 m	DD	BSB 35-50 Tuchel 5-pol.	High Flex Leder	7S9SH083520001A11
ABITIG® 24W Little	4 m	DD	BSB 35-50 Tuchel 5-pol.	High Flex Leder	7L9SH043520001A11
	8 m	DD	BSB 35-50 Tuchel 5-pol.	High Flex Leder	7L9SH083520001A11
<hr/>					
ABITIG® 450W	4 m	DD	BSB 35-50 Tuchel 5-pol.	Standard	7T5SK043520101A11
	8 m	DD	BSB 35-50 Tuchel 5-pol.	Standard	7T5SK083520101A11
	4 m	DD	BSB 35-50 Tuchel 5-pol.	High Flex Leder	7T5SH043520101A11
	8 m	DD	BSB 35-50 Tuchel 5-pol.	High Flex Leder	7T5SH083520101A11
<hr/>					
ABITIG® 260W	4 m	DD	BSB 35-50 Tuchel 5-pol.	Standard	7T7SK043520101A11
	8 m	DD	BSB 35-50 Tuchel 5-pol.	Standard	7T7SK083520101A11
	4 m	DD	BSB 35-50 Tuchel 5-pol.	High Flex Leder	7T7SH043520101A11
	8 m	DD	BSB 35-50 Tuchel 5-pol.	High Flex Leder	7T7SH083520101A11
ABITIG® 260W Little	4 m	DD	BSB 35-50 Tuchel 5-pol.	High Flex Leder	7L7SH043520101A11
	8 m	DD	BSB 35-50 Tuchel 5-pol.	High Flex Leder	7L7SH083520101A11
<hr/>					
ABITIG® 450W SC	4 m	DD	BSB 35-50 Tuchel 5-pol.	Standard	
	8 m	DD	BSB 35-50 Tuchel 5-pol.	Standard	
	4 m	DD	BSB 35-50 Tuchel 5-pol.	High Flex Leder	7T8SH043520101A11
	8 m	DD	BSB 35-50 Tuchel 5-pol.	High Flex Leder	7T8SH083520101A11

ABITIG® GRIP / ABITIG® GRIP Little-Brennerpreisliste

passend für WIG-Stromquellen des Fabrikates „ewm“

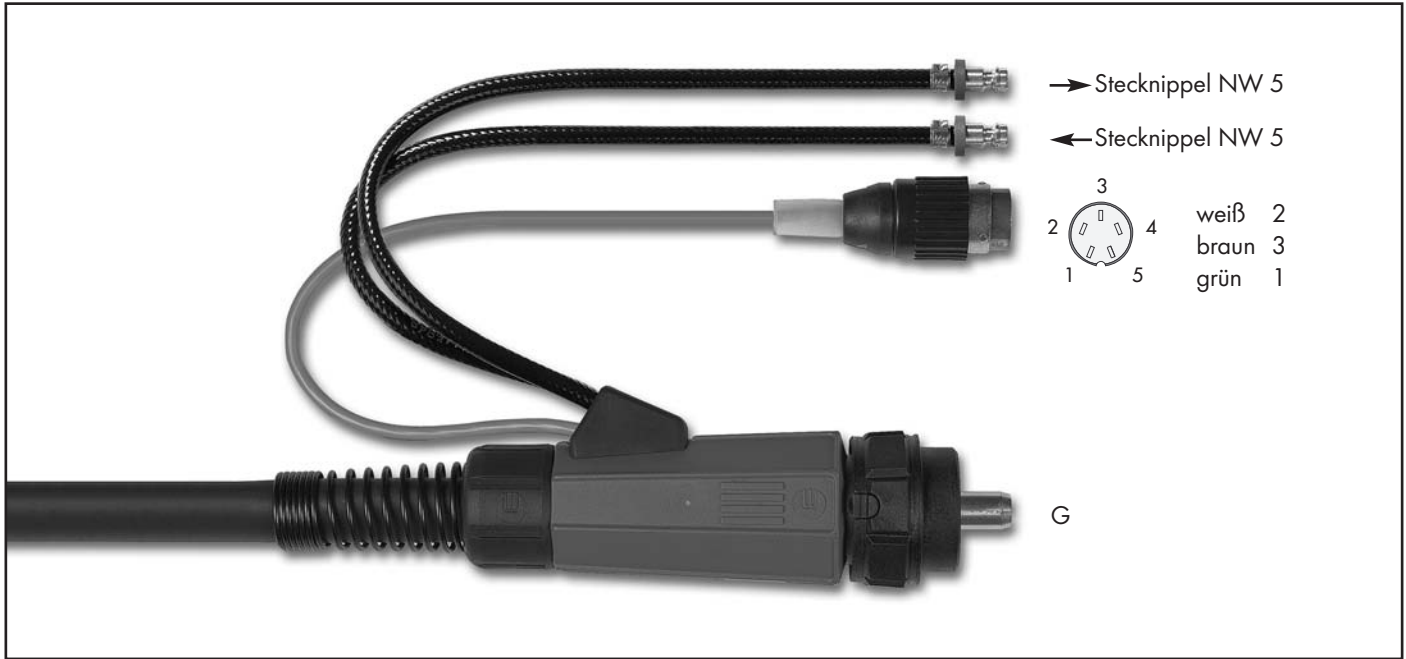

Brennertyp	Länge	Schalterfunktion	maschinenseitiger Anschluss	Schlauchpaketausführung	Bestellnummer
ABITIG® 18	4 m	DD	ZA - WZ-0 Tuchel 5-pol.	Standard	7S4SK043520301A12
	8 m	DD	ZA - WZ-0 Tuchel 5-pol.	Standard	7S4SK083520301A12
	4 m	DD	ZA - WZ-0 Tuchel 5-pol.	High Flex Leder	7S4SH043520301A12
	8 m	DD	ZA - WZ-0 Tuchel 5-pol.	High Flex Leder	7S4SH083520301A12
ABITIG® 18F	4 m	DD	ZA - WZ-0 Tuchel 5-pol.	Standard	7S4FK043520301A12
	8 m	DD	ZA - WZ-0 Tuchel 5-pol.	Standard	7S4FK083520301A12
	4 m	DD	ZA - WZ-0 Tuchel 5-pol.	High Flex Leder	7S4FH043520301A12
	8 m	DD	ZA - WZ-0 Tuchel 5-pol.	High Flex Leder	7S4FH083520301A12
ABITIG® 20	4 m	DD	ZA - WZ-0 Tuchel 5-pol.	Standard	7S5SK043520301A12
	8 m	DD	ZA - WZ-0 Tuchel 5-pol.	Standard	7S5SK083520301A12
	4 m	DD	ZA - WZ-0 Tuchel 5-pol.	High Flex Leder	7S5SH043520301A12
	8 m	DD	ZA - WZ-0 Tuchel 5-pol.	High Flex Leder	7S5SH083520301A12
ABITIG® 20 Little	4 m	DD	ZA - WZ-0 Tuchel 5-pol.	High Flex Leder	7L5SH043520301A12
	8 m	DD	ZA - WZ-0 Tuchel 5-pol.	High Flex Leder	7L5SH083520301A12
ABITIG® 20F	4 m	DD	ZA - WZ-0 Tuchel 5-pol.	Standard	7S5FK043520301A12
	8 m	DD	ZA - WZ-0 Tuchel 5-pol.	Standard	7S5FK083520301A12
	4 m	DD	ZA - WZ-0 Tuchel 5-pol.	High Flex Leder	7S5FH043520301A12
	8 m	DD	ZA - WZ-0 Tuchel 5-pol.	High Flex Leder	7S5FH083520301A12
ABITIG® 20F Little	4 m	DD	ZA - WZ-0 Tuchel 5-pol.	High Flex Leder	7L5FH043520301A12
	8 m	DD	ZA - WZ-0 Tuchel 5-pol.	High Flex Leder	7L5FH083520301A12

Technische Änderungen vorbehalten • Verkaufspreise = unverbindliche Preisempfehlung - Angebot freibleibend • © Copyright

ABITIG® GRIP / ABITIG® GRIP Little-Brennerpreisliste

passend für WIG-Stromquellen des Fabrikates „ewm“

Brennertyp	Länge	Schalterfunktion	maschinenseitiger Anschluss	Schlauchpaketausführung	Bestellnummer
ABITIG® 12-1	4 m	DD	ZA - WZ-0 Tuchel 5-pol.	Standard	7S6SK043520301A12
	8 m	DD	ZA - WZ-0 Tuchel 5-pol.	Standard	7S6SK083520301A12
	4 m	DD	ZA - WZ-0 Tuchel 5-pol.	High Flex Leder	7S6SH043520301A12
	8 m	DD	ZA - WZ-0 Tuchel 5-pol.	High Flex Leder	7S6SH083520301A12
<hr/>					
ABITIG® 18SC	4 m	DD	ZA - WZ-0 Tuchel 5-pol.	Standard	7S7SK043520301A12
	8 m	DD	ZA - WZ-0 Tuchel 5-pol.	Standard	7S7SK083520301A12
	4 m	DD	ZA - WZ-0 Tuchel 5-pol.	High Flex Leder	7S7SH043520301A12
	8 m	DD	ZA - WZ-0 Tuchel 5-pol.	High Flex Leder	7S7SH083520301A12
<hr/>					
ABITIG® 24W	4 m	DD	ZA - WZ-0 Tuchel 5-pol.	Standard	7S9SK043520301A12
	8 m	DD	ZA - WZ-0 Tuchel 5-pol.	Standard	7S9SK083520301A12
	4 m	DD	ZA - WZ-0 Tuchel 5-pol.	High Flex Leder	7S9SH043520301A12
	8 m	DD	ZA - WZ-0 Tuchel 5-pol.	High Flex Leder	7S9SH083520301A12
ABITIG® 24W Little	4 m	DD	ZA - WZ-0 Tuchel 5-pol.	High Flex Leder	7L9SH043520301A12
	8 m	DD	ZA - WZ-0 Tuchel 5-pol.	High Flex Leder	7L9SH083520301A12
<hr/>					
ABITIG® 450W	4 m	DD	ZA - WZ-0 Tuchel 5-pol.	Standard	7T5SK043520301A12
	8 m	DD	ZA - WZ-0 Tuchel 5-pol.	Standard	7T5SK083520301A12
	4 m	DD	ZA - WZ-0 Tuchel 5-pol.	High Flex Leder	7T5SH043520301A12
	8 m	DD	ZA - WZ-0 Tuchel 5-pol.	High Flex Leder	7T5SH083520301A12
<hr/>					
ABITIG® 260W	4 m	DD	ZA - WZ-0 Tuchel 5-pol.	Standard	7T7SK043520301A12
	8 m	DD	ZA - WZ-0 Tuchel 5-pol.	Standard	7T7SK083520301A12
	4 m	DD	ZA - WZ-0 Tuchel 5-pol.	High Flex Leder	7T7SH043520301A12
	8 m	DD	ZA - WZ-0 Tuchel 5-pol.	High Flex Leder	7T7SH083520301A12
ABITIG® 260W Little	4 m	DD	ZA - WZ-0 Tuchel 5-pol.	High Flex Leder	7L7SH043520301A12
	8 m	DD	ZA - WZ-0 Tuchel 5-pol.	High Flex Leder	7L7SH083520301A12
<hr/>					
ABITIG® 450W SC	4 m	DD	ZA - WZ-0 Tuchel 5-pol.	Standard	
	8 m	DD	ZA - WZ-0 Tuchel 5-pol.	Standard	
	4 m	DD	ZA - WZ-0 Tuchel 5-pol.	High Flex Leder	7T8SH043520301A12
	8 m	DD	ZA - WZ-0 Tuchel 5-pol.	High Flex Leder	7T8SH083520301A12

ABITIG® GRIP / ABITIG® GRIP Little-Brennerpreisliste

passend für WIG-Stromquellen des Fabrikates „ewm“



Brennertyp	Länge	Schalterfunktion	maschinenseitiger Anschluss	Schlauchpaketausführung	Bestellnummer
ABITIG® 18	4 m	DDP	BSB 35-50 Burndy 8-pol.	Standard	7S4SK046540028A11
	8 m	DDP	BSB 35-50 Burndy 8-pol.	Standard	7S4SK086540028A11
	4 m	DDP	BSB 35-50 Burndy 8-pol.	High Flex Leder	7S4SH046540028A11
	8 m	DDP	BSB 35-50 Burndy 8-pol.	High Flex Leder	7S4SH086540028A11
ABITIG® 18F	4 m	DDP	BSB 35-50 Burndy 8-pol.	Standard	7S4FK046540028A11
	8 m	DDP	BSB 35-50 Burndy 8-pol.	Standard	7S4FK086540028A11
	4 m	DDP	BSB 35-50 Burndy 8-pol.	High Flex Leder	7S4FH046540028A11
	8 m	DDP	BSB 35-50 Burndy 8-pol.	High Flex Leder	7S4FH086540028A11
ABITIG® 20	4 m	DDP	BSB 35-50 Burndy 8-pol.	Standard	7S5SK046540028A11
	8 m	DDP	BSB 35-50 Burndy 8-pol.	Standard	7S5SK086540028A11
	4 m	DDP	BSB 35-50 Burndy 8-pol.	High Flex Leder	7S5SH046540028A11
	8 m	DDP	BSB 35-50 Burndy 8-pol.	High Flex Leder	7S5SH086540028A11
ABITIG® 20F	4 m	DDP	BSB 35-50 Burndy 8-pol.	Standard	7S5FK046540028A11
	8 m	DDP	BSB 35-50 Burndy 8-pol.	Standard	7S5FK086540028A11
	4 m	DDP	BSB 35-50 Burndy 8-pol.	High Flex Leder	7S5FH046540028A11
	8 m	DDP	BSB 35-50 Burndy 8-pol.	High Flex Leder	7S5FH086540028A11

Technische Änderungen vorbehalten • Verkaufspreise = unverbindliche Preisempfehlung - Angebot freibleibend • © Copyright

ABITIG® GRIP / ABITIG® GRIP Little-Brennerpreisliste

passend für WIG-Stromquellen des Fabrikates „ewm“

Brennertyp	Länge	Schalterfunktion	maschinenseitiger Anschluss	Schlauchpaketausführung	Bestellnummer
ABITIG® 12-1	4 m	DDP	BSB 35-50 Burndy 8-pol.	Standard	7S6SK046540028A11
	8 m	DDP	BSB 35-50 Burndy 8-pol.	Standard	7S6SK086540028A11
	4 m	DDP	BSB 35-50 Burndy 8-pol.	High Flex Leder	7S6SH046540028A11
	8 m	DDP	BSB 35-50 Burndy 8-pol.	High Flex Leder	7S6SH086540028A11
ABITIG® 18SC	4 m	DDP	BSB 35-50 Burndy 8-pol.	Standard	7S7SK046540028A11
	8 m	DDP	BSB 35-50 Burndy 8-pol.	Standard	7S7SK086540028A11
	4 m	DDP	BSB 35-50 Burndy 8-pol.	High Flex Leder	7S7SH046540028A11
	8 m	DDP	BSB 35-50 Burndy 8-pol.	High Flex Leder	7S7SH086540028A11
ABITIG® 24W	4 m	DDP	BSB 35-50 Burndy 8-pol.	Standard	7S9SK046540028A11
	8 m	DDP	BSB 35-50 Burndy 8-pol.	Standard	7S9SK086540028A11
	4 m	DDP	BSB 35-50 Burndy 8-pol.	High Flex Leder	7S9SH046540028A11
	8 m	DDP	BSB 35-50 Burndy 8-pol.	High Flex Leder	7S9SH086540028A11
ABITIG® 450W	4 m	DDP	BSB 35-50 Burndy 8-pol.	Standard	7T5SK046540128A11
	8 m	DDP	BSB 35-50 Burndy 8-pol.	Standard	7T5SK086540128A11
	4 m	DDP	BSB 35-50 Burndy 8-pol.	High Flex Leder	7T5SH046540128A11
	8 m	DDP	BSB 35-50 Burndy 8-pol.	High Flex Leder	7T5SH086540128A11
ABITIG® 260W	4 m	DDP	BSB 35-50 Burndy 8-pol.	Standard	7T7SK046540128A11
	8 m	DDP	BSB 35-50 Burndy 8-pol.	Standard	7T7SK086540128A11
	4 m	DDP	BSB 35-50 Burndy 8-pol.	High Flex Leder	7T7SH046540128A11
	8 m	DDP	BSB 35-50 Burndy 8-pol.	High Flex Leder	7T7SH086540128A11
ABITIG® 450W SC	4 m	DDP	BSB 35-50 Burndy 8-pol.	Standard	
	8 m	DDP	BSB 35-50 Burndy 8-pol.	Standard	
	4 m	DDP	BSB 35-50 Burndy 8-pol.	High Flex Leder	7T8SH046540128A11
	8 m	DDP	BSB 35-50 Burndy 8-pol.	High Flex Leder	7T8SH086540128A11

ABITIG® GRIP / ABITIG® GRIP Little-Brennerpreisliste

passend für WIG-Stromquellen des Fabrikates „ewm“



Brennertyp	Länge	Schalterfunktion	maschinenseitiger Anschluss	Schlauchpaketausführung	Bestellnummer
ABITIG® 18	4 m	DDP	BSB 35-50 Tuchel 5-pol. + AMP 14-pol.	Standard	7S4SK046540023A11
	8 m	DDP	BSB 35-50 Tuchel 5-pol. + AMP 14-pol.	Standard	7S4SK086540023A11
	4 m	DDP	BSB 35-50 Tuchel 5-pol. + AMP 14-pol.	High Flex Leder	7S4SH046540023A11
	8 m	DDP	BSB 35-50 Tuchel 5-pol. + AMP 14-pol.	High Flex Leder	7S4SH086540023A11
ABITIG® 18F	4 m	DDP	BSB 35-50 Tuchel 5-pol. + AMP 14-pol.	Standard	7S4FK046540023A11
	8 m	DDP	BSB 35-50 Tuchel 5-pol. + AMP 14-pol.	Standard	7S4FK086540023A11
	4 m	DDP	BSB 35-50 Tuchel 5-pol. + AMP 14-pol.	High Flex Leder	7S4FH046540023A11
	8 m	DDP	BSB 35-50 Tuchel 5-pol. + AMP 14-pol.	High Flex Leder	7S4FH086540023A11
ABITIG® 20	4 m	DDP	BSB 35-50 Tuchel 5-pol. + AMP 14-pol.	Standard	7S5SK046540023A11
	8 m	DDP	BSB 35-50 Tuchel 5-pol. + AMP 14-pol.	Standard	7S5SK086540023A11
	4 m	DDP	BSB 35-50 Tuchel 5-pol. + AMP 14-pol.	High Flex Leder	7S5SH046540023A11
	8 m	DDP	BSB 35-50 Tuchel 5-pol. + AMP 14-pol.	High Flex Leder	7S5SH086540023A11
ABITIG® 20F	4 m	DDP	BSB 35-50 Tuchel 5-pol. + AMP 14-pol.	Standard	7S5FK046540023A11
	8 m	DDP	BSB 35-50 Tuchel 5-pol. + AMP 14-pol.	Standard	7S5FK086540023A11
	4 m	DDP	BSB 35-50 Tuchel 5-pol. + AMP 14-pol.	High Flex Leder	7S5FH046540023A11
	8 m	DDP	BSB 35-50 Tuchel 5-pol. + AMP 14-pol.	High Flex Leder	7S5FH086540023A11

Technische Änderungen vorbehalten • Verkaufspreise = unverbindliche Preisempfehlung - Angebot freibleibend • © Copyright

ABITIG® GRIP / ABITIG® GRIP Little-Brennerpreisliste

passend für WIG-Stromquellen des Fabrikates „ewm“

Brennertyp	Länge	Schalterfunktion	maschinenseitiger Anschluss	Schlauchpaketausführung	Bestellnummer
ABITIG® 12-1	4 m	DDP	BSB 35-50 Tuchel 5-pol. + AMP 14-pol.	Standard	7S6SK046540023A11
	8 m	DDP	BSB 35-50 Tuchel 5-pol. + AMP 14-pol.	Standard	7S6SK086540023A11
	4 m	DDP	BSB 35-50 Tuchel 5-pol. + AMP 14-pol.	High Flex Leder	7S6SH046540023A11
	8 m	DDP	BSB 35-50 Tuchel 5-pol. + AMP 14-pol.	High Flex Leder	7S6SH086540023A11

ABITIG® 18SC	4 m	DDP	BSB 35-50 Tuchel 5-pol. + AMP 14-pol.	Standard	7S7SK046540023A11
	8 m	DDP	BSB 35-50 Tuchel 5-pol. + AMP 14-pol.	Standard	7S7SK086540023A11
	4 m	DDP	BSB 35-50 Tuchel 5-pol. + AMP 14-pol.	High Flex Leder	7S7SH046540023A11
	8 m	DDP	BSB 35-50 Tuchel 5-pol. + AMP 14-pol.	High Flex Leder	7S7SH086540023A11

ABITIG® 24W	4 m	DDP	BSB 35-50 Tuchel 5-pol. + AMP 14-pol.	Standard	7S9SK046540023A11
	8 m	DDP	BSB 35-50 Tuchel 5-pol. + AMP 14-pol.	Standard	7S9SK086540023A11
	4 m	DDP	BSB 35-50 Tuchel 5-pol. + AMP 14-pol.	High Flex Leder	7S9SH046540023A11
	8 m	DDP	BSB 35-50 Tuchel 5-pol. + AMP 14-pol.	High Flex Leder	7S9SH086540023A11

ABITIG® 450W	4 m	DDP	BSB 35-50 Tuchel 5-pol. + AMP 14-pol.	Standard	7T5SK046540123A11
	8 m	DDP	BSB 35-50 Tuchel 5-pol. + AMP 14-pol.	Standard	7T5SK086540123A11
	4 m	DDP	BSB 35-50 Tuchel 5-pol. + AMP 14-pol.	High Flex Leder	7T5SH046540123A11
	8 m	DDP	BSB 35-50 Tuchel 5-pol. + AMP 14-pol.	High Flex Leder	7T5SH086540123A11

ABITIG® 260W	4 m	DDP	BSB 35-50 Tuchel 5-pol. + AMP 14-pol.	Standard	7T7SK046540123A11
	8 m	DDP	BSB 35-50 Tuchel 5-pol. + AMP 14-pol.	Standard	7T7SK086540123A11
	4 m	DDP	BSB 35-50 Tuchel 5-pol. + AMP 14-pol.	High Flex Leder	7T7SH046540123A11
	8 m	DDP	BSB 35-50 Tuchel 5-pol. + AMP 14-pol.	High Flex Leder	7T7SH086540123A11

ABITIG® 450W SC	4 m	DDP	BSB 35-50 Tuchel 5-pol. + AMP 14-pol.	Standard	
	8 m	DDP	BSB 35-50 Tuchel 5-pol. + AMP 14-pol.	Standard	
	4 m	DDP	BSB 35-50 Tuchel 5-pol. + AMP 14-pol.	High Flex Leder	7T8SH046540123A11
	8 m	DDP	BSB 35-50 Tuchel 5-pol. + AMP 14-pol.	High Flex Leder	7T8SH086540123A11

ABITIG® GRIP / ABITIG® GRIP Little-Brennerpreisliste

passend für WIG-Stromquellen des Fabrikates „ewm“ Up/Down



Brennertyp	Länge	Schalterfunktion	maschinenseitiger Anschluss	Schlauchpaketausführung	Bestellnummer
ABITIG® 18	4 m	UD	BSB 35-50 Burndy 8-pol.	Standard	7S4SK046650037B11
	8 m	UD	BSB 35-50 Burndy 8-pol.	Standard	7S4SK086650037B11
	4 m	UD	BSB 35-50 Burndy 8-pol.	High Flex Leder	7S4SH046650037B11
	8 m	UD	BSB 35-50 Burndy 8-pol.	High Flex Leder	7S4SH086650037B11
ABITIG® 18F	4 m	UD	BSB 35-50 Burndy 8-pol.	Standard	7S4FK046650037B11
	8 m	UD	BSB 35-50 Burndy 8-pol.	Standard	7S4FK086650037B11
	4 m	UD	BSB 35-50 Burndy 8-pol.	High Flex Leder	7S4FH046650037B11
	8 m	UD	BSB 35-50 Burndy 8-pol.	High Flex Leder	7S4FH086650037B11
ABITIG® 20	4 m	UD	BSB 35-50 Burndy 8-pol.	Standard	7S5SK046650037B11
	8 m	UD	BSB 35-50 Burndy 8-pol.	Standard	7S5SK086650037B11
	4 m	UD	BSB 35-50 Burndy 8-pol.	High Flex Leder	7S5SH046650037B11
	8 m	UD	BSB 35-50 Burndy 8-pol.	High Flex Leder	7S5SH086650037B11
ABITIG® 20 Little	4 m	UD	BSB 35-50 Burndy 8-pol.	High Flex Leder	7L5SH046650037B11
	8 m	UD	BSB 35-50 Burndy 8-pol.	High Flex Leder	7L5SH086650037B11
ABITIG® 20F	4 m	UD	BSB 35-50 Burndy 8-pol.	Standard	7S5FK046650037B11
	8 m	UD	BSB 35-50 Burndy 8-pol.	Standard	7S5FK086650037B11
	4 m	UD	BSB 35-50 Burndy 8-pol.	High Flex Leder	7S5FH046650037B11
	8 m	UD	BSB 35-50 Burndy 8-pol.	High Flex Leder	7S5FH086650037B11
ABITIG® 20F Little	4 m	UD	BSB 35-50 Burndy 8-pol.	High Flex Leder	7L5FH046650037B11
	8 m	UD	BSB 35-50 Burndy 8-pol.	High Flex Leder	7L5FH086650037B11

Technische Änderungen vorbehalten • Verkaufspreise = unverbindliche Preisempfehlung - Angebot freibleibend • © Copyright

ABITIG® GRIP / ABITIG® GRIP Little-Brennerpreisliste

passend für WIG-Stromquellen des Fabrikates „ewm“ Up/Down

Brennertyp	Länge	Schalterfunktion	maschinenseitiger Anschluss	Schlauchpaketausführung	Bestellnummer
ABITIG® 12-1	4 m	UD	BSB 35-50 Burndy 8-pol.	Standard	7S6SK046650037B11
	8 m	UD	BSB 35-50 Burndy 8-pol.	Standard	7S6SK086650037B11
	4 m	UD	BSB 35-50 Burndy 8-pol.	High Flex Leder	7S6SH046650037B11
	8 m	UD	BSB 35-50 Burndy 8-pol.	High Flex Leder	7S6SH086650037B11
<hr/>					
ABITIG® 18SC	4 m	UD	BSB 35-50 Burndy 8-pol.	Standard	7S7SK046650037B11
	8 m	UD	BSB 35-50 Burndy 8-pol.	Standard	7S7SK086650037B11
	4 m	UD	BSB 35-50 Burndy 8-pol.	High Flex Leder	7S7SH046650037B11
	8 m	UD	BSB 35-50 Burndy 8-pol.	High Flex Leder	7S7SH086650037B11
<hr/>					
ABITIG® 24W	4 m	UD	BSB 35-50 Burndy 8-pol.	Standard	7S9SK046650037B11
	8 m	UD	BSB 35-50 Burndy 8-pol.	Standard	7S9SK086650037B11
	4 m	UD	BSB 35-50 Burndy 8-pol.	High Flex Leder	7S9SH046650037B11
	8 m	UD	BSB 35-50 Burndy 8-pol.	High Flex Leder	7S9SH086650037B11
ABITIG® 24W Little	4 m	UD	BSB 35-50 Burndy 8-pol.	High Flex Leder	7L9SH046650037B11
	8 m	UD	BSB 35-50 Burndy 8-pol.	High Flex Leder	7L9SH086650037B11
<hr/>					
ABITIG® 450W	4 m	UD	BSB 35-50 Burndy 8-pol.	Standard	7T5SK046650137B11
	8 m	UD	BSB 35-50 Burndy 8-pol.	Standard	7T5SK086650137B11
	4 m	UD	BSB 35-50 Burndy 8-pol.	High Flex Leder	7T5SH046650137B11
	8 m	UD	BSB 35-50 Burndy 8-pol.	High Flex Leder	7T5SH086650137B11
<hr/>					
ABITIG® 260W	4 m	UD	BSB 35-50 Burndy 8-pol.	Standard	7T7SK046650137B11
	8 m	UD	BSB 35-50 Burndy 8-pol.	Standard	7T7SK086650137B11
	4 m	UD	BSB 35-50 Burndy 8-pol.	High Flex Leder	7T7SH046650137B11
	8 m	UD	BSB 35-50 Burndy 8-pol.	High Flex Leder	7T7SH086650137B11
ABITIG® 260W Little	4 m	UD	BSB 35-50 Burndy 8-pol.	High Flex Leder	7L7SH046650137B11
	8 m	UD	BSB 35-50 Burndy 8-pol.	High Flex Leder	7L7SH086650137B11
<hr/>					
ABITIG® 450W SC	4 m	UD	BSB 35-50 Burndy 8-pol.	Standard	
	8 m	UD	BSB 35-50 Burndy 8-pol.	Standard	
	4 m	UD	BSB 35-50 Burndy 8-pol.	High Flex Leder	7T8SH046650137B11
	8 m	UD	BSB 35-50 Burndy 8-pol.	High Flex Leder	7T8SH086650137B11
<hr/>					
<hr/>					

ABITIG® GRIP / ABITIG® GRIP Little-Brennerpreisliste

passend für WIG-Stromquellen des Fabrikates „fronius“



Brennertyp	Länge	Schalterfunktion	maschinenseitiger Anschluss	Schlauchpaketausführung	Bestellnummer
ABITIG® 9	4 m	DD	EA Rechtecksteckverbinder 9-pol.	Standard	7S1SK043520615A00
	8 m	DD	EA Rechtecksteckverbinder 9-pol.	Standard	7S1SK083520615A00
	4 m	DD	EA Rechtecksteckverbinder 9-pol.	High Flex Leder	7S1SH043520615A00
	8 m	DD	EA Rechtecksteckverbinder 9-pol.	High Flex Leder	7S1SH083520615A00
ABITIG® 9 Little	4 m	DD	EA Rechtecksteckverbinder 9-pol.	High Flex Leder	7L1SH043520615A00
	8 m	DD	EA Rechtecksteckverbinder 9-pol.	High Flex Leder	7L1SH083520615A00
ABITIG® 9F	4 m	DD	EA Rechtecksteckverbinder 9-pol.	Standard	7S1FK043520615A00
	8 m	DD	EA Rechtecksteckverbinder 9-pol.	Standard	7S1FK083520615A00
	4 m	DD	EA Rechtecksteckverbinder 9-pol.	High Flex Leder	7S1FH043520615A00
	8 m	DD	EA Rechtecksteckverbinder 9-pol.	High Flex Leder	7S1FH083520615A00
ABITIG® 9F Little	4 m	DD	EA Rechtecksteckverbinder 9-pol.	High Flex Leder	7L1FH043520615A00
	8 m	DD	EA Rechtecksteckverbinder 9-pol.	High Flex Leder	7L1FH083520615A00
ABITIG® 17	4 m	DD	EA Rechtecksteckverbinder 9-pol.	Standard	7S2SK043520615A00
	8 m	DD	EA Rechtecksteckverbinder 9-pol.	Standard	7S2SK083520615A00
	4 m	DD	EA Rechtecksteckverbinder 9-pol.	High Flex Leder	7S2SH043520615A00
	8 m	DD	EA Rechtecksteckverbinder 9-pol.	High Flex Leder	7S2SH083520615A00
ABITIG® 17 Little	4 m	DD	EA Rechtecksteckverbinder 9-pol.	High Flex Leder	7L2SH043520615A00
	8 m	DD	EA Rechtecksteckverbinder 9-pol.	High Flex Leder	7L2SH083520615A00
ABITIG® 17F	4 m	DD	EA Rechtecksteckverbinder 9-pol.	Standard	7S2FK043520615A00
	8 m	DD	EA Rechtecksteckverbinder 9-pol.	Standard	7S2FK083520615A00
	4 m	DD	EA Rechtecksteckverbinder 9-pol.	High Flex Leder	7S2FH043520615A00
	8 m	DD	EA Rechtecksteckverbinder 9-pol.	High Flex Leder	7S2FH083520615A00
ABITIG® 17F Little	4 m	DD	EA Rechtecksteckverbinder 9-pol.	High Flex Leder	7L2FH043520615A00
	8 m	DD	EA Rechtecksteckverbinder 9-pol.	High Flex Leder	7L2FH083520615A00

Technische Änderungen vorbehalten • Verkaufspreise = unverbindliche Preisempfehlung - Angebot freibleibend • © Copyright

ABITIG® GRIP / ABITIG® GRIP Little-Brennerpreisliste

passend für WIG-Stromquellen des Fabrikates „fronius“

Brennertyp	Länge	Schalterfunktion	maschinenseitiger Anschluss	Schlauchpaketausführung	Bestellnummer
ABITIG® 26	4 m	DD	EA Rechtecksteckverbinder 9-pol.	Standard	7S3SK043520615A00
	8 m	DD	EA Rechtecksteckverbinder 9-pol.	Standard	7S3SK083520615A00
	4 m	DD	EA Rechtecksteckverbinder 9-pol.	High Flex Leder	7S3SH043520615A00
	8 m	DD	EA Rechtecksteckverbinder 9-pol.	High Flex Leder	7S3SH083520615A00
ABITIG® 26F	4 m	DD	EA Rechtecksteckverbinder 9-pol.	Standard	7S3FK043520615A00
	8 m	DD	EA Rechtecksteckverbinder 9-pol.	Standard	7S3FK083520615A00
	4 m	DD	EA Rechtecksteckverbinder 9-pol.	High Flex Leder	7S3FH043520615A00
	8 m	DD	EA Rechtecksteckverbinder 9-pol.	High Flex Leder	7S3FH083520615A00
ABITIG® 24G	4 m	DD	EA Rechtecksteckverbinder 9-pol.	Standard	7S8SK043520615A00
	8 m	DD	EA Rechtecksteckverbinder 9-pol.	Standard	7S8SK083520615A00
	4 m	DD	EA Rechtecksteckverbinder 9-pol.	High Flex Leder	7S8SH043520615A00
	8 m	DD	EA Rechtecksteckverbinder 9-pol.	High Flex Leder	7S8SH083520615A00
ABITIG® 24G Little	4 m	DD	EA Rechtecksteckverbinder 9-pol.	High Flex Leder	7L8SH043520615A00
	8 m	DD	EA Rechtecksteckverbinder 9-pol.	High Flex Leder	7L8SH083520615A00
ABITIG® 200	4 m	DD	EA Rechtecksteckverbinder 9-pol.	Standard	7T4SK043520615A00
	8 m	DD	EA Rechtecksteckverbinder 9-pol.	Standard	7T4SK083520615A00
	4 m	DD	EA Rechtecksteckverbinder 9-pol.	High Flex Leder	7T4SH043520615A00
	8 m	DD	EA Rechtecksteckverbinder 9-pol.	High Flex Leder	7T4SH083520615A00
ABITIG® 200F	4 m	DD	EA Rechtecksteckverbinder 9-pol.	Standard	7T4FK043520615A00
	8 m	DD	EA Rechtecksteckverbinder 9-pol.	Standard	7T4FK083520615A00
	4 m	DD	EA Rechtecksteckverbinder 9-pol.	High Flex Leder	7T4FH043520615A00
	8 m	DD	EA Rechtecksteckverbinder 9-pol.	High Flex Leder	7T4FH083520615A00
ABITIG® 150	4 m	DD	EA Rechtecksteckverbinder 9-pol.	Standard	7T6SK043520615A00
	8 m	DD	EA Rechtecksteckverbinder 9-pol.	Standard	7T6SK083520615A00
	4 m	DD	EA Rechtecksteckverbinder 9-pol.	High Flex Leder	7T6SH043520615A00
	8 m	DD	EA Rechtecksteckverbinder 9-pol.	High Flex Leder	7T6SH083520615A00
ABITIG® 150 Little	4 m	DD	EA Rechtecksteckverbinder 9-pol.	High Flex Leder	7L6SH043520615A00
	8 m	DD	EA Rechtecksteckverbinder 9-pol.	High Flex Leder	7L6SH083520615A00
ABITIG® 150F	4 m	DD	EA Rechtecksteckverbinder 9-pol.	Standard	7T6FK043520615A00
	8 m	DD	EA Rechtecksteckverbinder 9-pol.	Standard	7T6FK083520615A00
	4 m	DD	EA Rechtecksteckverbinder 9-pol.	High Flex Leder	7T6FH043520615A00
	8 m	DD	EA Rechtecksteckverbinder 9-pol.	High Flex Leder	7T6FH083520615A00
ABITIG® 150F Little	4 m	DD	EA Rechtecksteckverbinder 9-pol.	High Flex Leder	7L6FH043520615A00
	8 m	DD	EA Rechtecksteckverbinder 9-pol.	High Flex Leder	7L6FH083520615A00

ABITIG® GRIP / ABITIG® GRIP Little-Brennerpreisliste

passend für WIG-Stromquellen des Fabrikates „fronius“ Up/Down



Brennertyp	Länge	Schalterfunktion	maschinenseitiger Anschluss	Schlauchpaketausführung	Bestellnummer
ABITIG® 9	4 m	UD	EA Rechtecksteckverbinder 9-pol.	Standard	7S1SK046650616A00
	8 m	UD	EA Rechtecksteckverbinder 9-pol.	Standard	7S1SK086650616A00
	4 m	UD	EA Rechtecksteckverbinder 9-pol.	High Flex Leder	7S1SH046650616A00
	8 m	UD	EA Rechtecksteckverbinder 9-pol.	High Flex Leder	7S1SH086650616A00
ABITIG® 9 Little	4 m	UD	EA Rechtecksteckverbinder 9-pol.	High Flex Leder	7L1SH046650616A00
	8 m	UD	EA Rechtecksteckverbinder 9-pol.	High Flex Leder	7L1SH086650616A00
ABITIG® 9F	4 m	UD	EA Rechtecksteckverbinder 9-pol.	Standard	7S1FK046650616A00
	8 m	UD	EA Rechtecksteckverbinder 9-pol.	Standard	7S1FK086650616A00
	4 m	UD	EA Rechtecksteckverbinder 9-pol.	High Flex Leder	7S1FH046650616A00
	8 m	UD	EA Rechtecksteckverbinder 9-pol.	High Flex Leder	7S1FH086650616A00
ABITIG® 9F Little	4 m	UD	EA Rechtecksteckverbinder 9-pol.	High Flex Leder	7L1FH046650616A00
	8 m	UD	EA Rechtecksteckverbinder 9-pol.	High Flex Leder	7L1FH086650616A00
ABITIG® 17	4 m	UD	EA Rechtecksteckverbinder 9-pol.	Standard	7S2SK046650616A00
	8 m	UD	EA Rechtecksteckverbinder 9-pol.	Standard	7S2SK086650616A00
	4 m	UD	EA Rechtecksteckverbinder 9-pol.	High Flex Leder	7S2SH046650616A00
	8 m	UD	EA Rechtecksteckverbinder 9-pol.	High Flex Leder	7S2SH086650616A00
ABITIG® 17 Little	4 m	UD	EA Rechtecksteckverbinder 9-pol.	High Flex Leder	7L2SH046650616A00
	8 m	UD	EA Rechtecksteckverbinder 9-pol.	High Flex Leder	7L2SH086650616A00
ABITIG® 17F	4 m	UD	EA Rechtecksteckverbinder 9-pol.	Standard	7S2FK046650616A00
	8 m	UD	EA Rechtecksteckverbinder 9-pol.	Standard	7S2FK086650616A00
	4 m	UD	EA Rechtecksteckverbinder 9-pol.	High Flex Leder	7S2FH046650616A00
	8 m	UD	EA Rechtecksteckverbinder 9-pol.	High Flex Leder	7S2FH086650616A00
ABITIG® 17F Little	4 m	UD	EA Rechtecksteckverbinder 9-pol.	High Flex Leder	7L2FH046650616A00
	8 m	UD	EA Rechtecksteckverbinder 9-pol.	High Flex Leder	7L2FH086650616A00

Technische Änderungen vorbehalten • Verkaufspreise = unverbindliche Preisempfehlung - Angebot freibleibend • © Copyright

ABITIG® GRIP / ABITIG® GRIP Little-Brennerpreisliste

passend für WIG-Stromquellen des Fabrikates „fronius“ Up/Down

Brennertyp	Länge	Schalterfunktion	maschinenseitiger Anschluss	Schlauchpaketausführung	Bestellnummer
ABITIG® 26	4 m	UD	EA Rechtecksteckverbinder 9-pol.	Standard	7S3SK046650616A00
	8 m	UD	EA Rechtecksteckverbinder 9-pol.	Standard	7S3SK086650616A00
	4 m	UD	EA Rechtecksteckverbinder 9-pol.	High Flex Leder	7S3SH046650616A00
	8 m	UD	EA Rechtecksteckverbinder 9-pol.	High Flex Leder	7S3SH086650616A00
ABITIG® 26F	4 m	UD	EA Rechtecksteckverbinder 9-pol.	Standard	7S3FK046650616A00
	8 m	UD	EA Rechtecksteckverbinder 9-pol.	Standard	7S3FK086650616A00
	4 m	UD	EA Rechtecksteckverbinder 9-pol.	High Flex Leder	7S3FH046650616A00
	8 m	UD	EA Rechtecksteckverbinder 9-pol.	High Flex Leder	7S3FH086650616A00
ABITIG® 24G	4 m	UD	EA Rechtecksteckverbinder 9-pol.	Standard	7S8SK046650616A00
	8 m	UD	EA Rechtecksteckverbinder 9-pol.	Standard	7S8SK086650616A00
	4 m	UD	EA Rechtecksteckverbinder 9-pol.	High Flex Leder	7S8SH046650616A00
	8 m	UD	EA Rechtecksteckverbinder 9-pol.	High Flex Leder	7S8SH086650616A00
ABITIG® 24G Little	4 m	UD	EA Rechtecksteckverbinder 9-pol.	High Flex Leder	7L8SH046650616A00
	8 m	UD	EA Rechtecksteckverbinder 9-pol.	High Flex Leder	7L8SH086650616A00
ABITIG® 200	4 m	UD	EA Rechtecksteckverbinder 9-pol.	Standard	7T4SK046650616A00
	8 m	UD	EA Rechtecksteckverbinder 9-pol.	Standard	7T4SK086650616A00
	4 m	UD	EA Rechtecksteckverbinder 9-pol.	High Flex Leder	7T4SH046650616A00
	8 m	UD	EA Rechtecksteckverbinder 9-pol.	High Flex Leder	7T4SH086650616A00
ABITIG® 200F	4 m	UD	EA Rechtecksteckverbinder 9-pol.	Standard	7T4FK046650616A00
	8 m	UD	EA Rechtecksteckverbinder 9-pol.	Standard	7T4FK086650616A00
	4 m	UD	EA Rechtecksteckverbinder 9-pol.	High Flex Leder	7T4FH046650616A00
	8 m	UD	EA Rechtecksteckverbinder 9-pol.	High Flex Leder	7T4FH086650616A00
ABITIG® 150	4 m	UD	EA Rechtecksteckverbinder 9-pol.	Standard	7T6SK046650616A00
	8 m	UD	EA Rechtecksteckverbinder 9-pol.	Standard	7T6SK086650616A00
	4 m	UD	EA Rechtecksteckverbinder 9-pol.	High Flex Leder	7T6SH046650616A00
	8 m	UD	EA Rechtecksteckverbinder 9-pol.	High Flex Leder	7T6SH086650616A00
ABITIG® 150 Little	4 m	UD	EA Rechtecksteckverbinder 9-pol.	High Flex Leder	7L6SH046650616A00
	8 m	UD	EA Rechtecksteckverbinder 9-pol.	High Flex Leder	7L6SH086650616A00
ABITIG® 150F	4 m	UD	EA Rechtecksteckverbinder 9-pol.	Standard	7T6FK046650616A00
	8 m	UD	EA Rechtecksteckverbinder 9-pol.	Standard	7T6FK086650616A00
	4 m	UD	EA Rechtecksteckverbinder 9-pol.	High Flex Leder	7T6FH046650616A00
	8 m	UD	EA Rechtecksteckverbinder 9-pol.	High Flex Leder	7T6FH086650616A00
ABITIG® 150F Little	4 m	UD	EA Rechtecksteckverbinder 9-pol.	High Flex Leder	7L6FH046650616A00
	8 m	UD	EA Rechtecksteckverbinder 9-pol.	High Flex Leder	7L6FH086650616A00

ABITIG® GRIP / ABITIG® GRIP Little-Brennerpreisliste

passend für WIG-Stromquellen des Fabrikates „fronius“

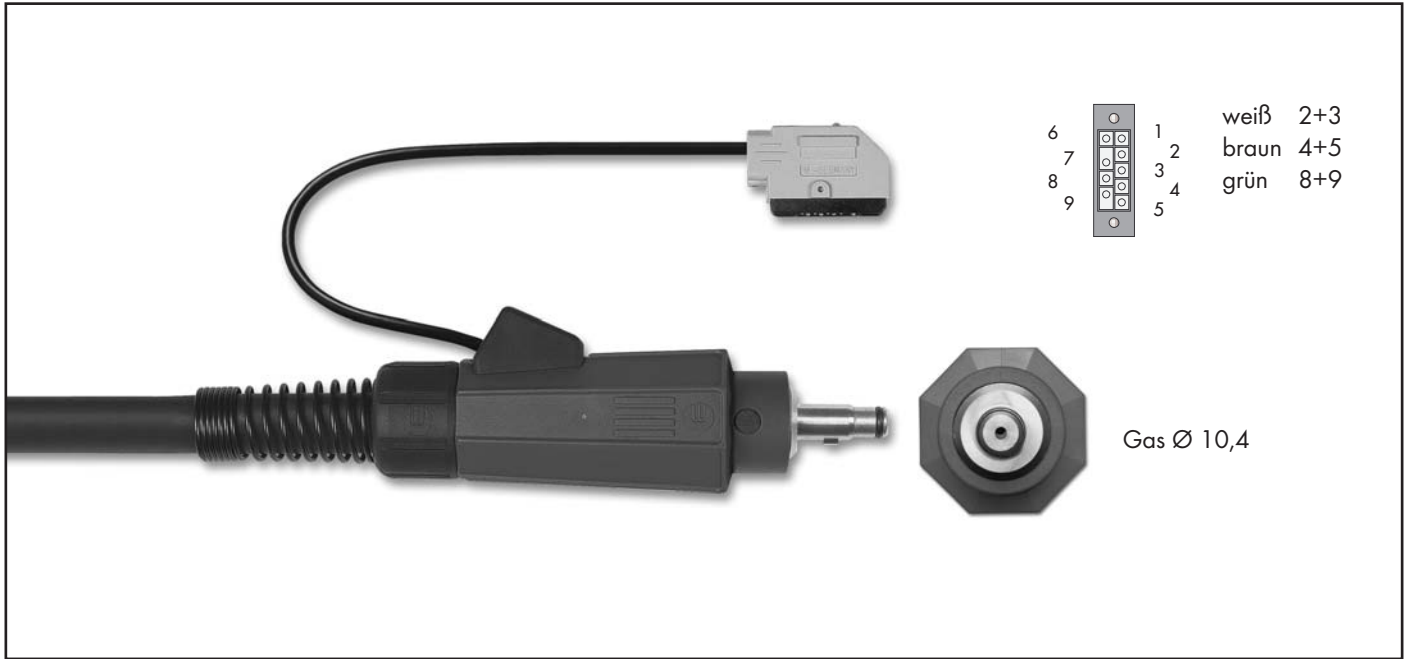

Brennertyp	Länge	Schalterfunktion	maschinenseitiger Anschluss	Schlauchpaketausführung	Bestellnummer
ABITIG® 9	4 m	DD	ZA Rechtecksteckverbinder 9-pol.	Standard	7S1SK043523615A00
	8 m	DD	ZA Rechtecksteckverbinder 9-pol.	Standard	7S1SK083523615A00
	4 m	DD	ZA Rechtecksteckverbinder 9-pol.	High Flex Leder	7S1SH043523615A00
	8 m	DD	ZA Rechtecksteckverbinder 9-pol.	High Flex Leder	7S1SH083523615A00
ABITIG® 9 Little	4 m	DD	ZA Rechtecksteckverbinder 9-pol.	High Flex Leder	7L1SH043523615A00
	8 m	DD	ZA Rechtecksteckverbinder 9-pol.	High Flex Leder	7L1SH083523615A00
ABITIG® 9F	4 m	DD	ZA Rechtecksteckverbinder 9-pol.	Standard	7S1FK043523615A00
	8 m	DD	ZA Rechtecksteckverbinder 9-pol.	Standard	7S1FK083523615A00
	4 m	DD	ZA Rechtecksteckverbinder 9-pol.	High Flex Leder	7S1FH043523615A00
	8 m	DD	ZA Rechtecksteckverbinder 9-pol.	High Flex Leder	7S1FH083523615A00
ABITIG® 9F Little	4 m	DD	ZA Rechtecksteckverbinder 9-pol.	High Flex Leder	7L1FH043523615A00
	8 m	DD	ZA Rechtecksteckverbinder 9-pol.	High Flex Leder	7L1FH083523615A00
ABITIG® 17	4 m	DD	ZA Rechtecksteckverbinder 9-pol.	Standard	7S2SK043523615A00
	8 m	DD	ZA Rechtecksteckverbinder 9-pol.	Standard	7S2SK083523615A00
	4 m	DD	ZA Rechtecksteckverbinder 9-pol.	High Flex Leder	7S2SH043523615A00
	8 m	DD	ZA Rechtecksteckverbinder 9-pol.	High Flex Leder	7S2SH083523615A00
ABITIG® 17 Little	4 m	DD	ZA Rechtecksteckverbinder 9-pol.	High Flex Leder	7L2SH043523615A00
	8 m	DD	ZA Rechtecksteckverbinder 9-pol.	High Flex Leder	7L2SH083523615A00
ABITIG® 17F	4 m	DD	ZA Rechtecksteckverbinder 9-pol.	Standard	7S2FK043523615A00
	8 m	DD	ZA Rechtecksteckverbinder 9-pol.	Standard	7S2FK083523615A00
	4 m	DD	ZA Rechtecksteckverbinder 9-pol.	High Flex Leder	7S2FH043523615A00
	8 m	DD	ZA Rechtecksteckverbinder 9-pol.	High Flex Leder	7S2FH083523615A00
ABITIG® 17F Little	4 m	DD	ZA Rechtecksteckverbinder 9-pol.	High Flex Leder	7L2FH043523615A00
	8 m	DD	ZA Rechtecksteckverbinder 9-pol.	High Flex Leder	7L2FH083523615A00

Technische Änderungen vorbehalten • Verkaufspreise = unverbindliche Preisempfehlung - Angebot freibleibend • © Copyright

ABITIG® GRIP / ABITIG® GRIP Little-Brennerpreisliste

passend für WIG-Stromquellen des Fabrikates „fronius“

Brennertyp	Länge	Schalterfunktion	maschinenseitiger Anschluss	Schlauchpaketausführung	Bestellnummer
ABITIG® 26	4 m	DD	ZA Rechtecksteckverbinder 9-pol.	Standard	7S3SK043523615A00
	8 m	DD	ZA Rechtecksteckverbinder 9-pol.	Standard	7S3SK083523615A00
	4 m	DD	ZA Rechtecksteckverbinder 9-pol.	High Flex Leder	7S3SH043523615A00
	8 m	DD	ZA Rechtecksteckverbinder 9-pol.	High Flex Leder	7S3SH083523615A00
ABITIG® 26F	4 m	DD	ZA Rechtecksteckverbinder 9-pol.	Standard	7S3FK043523615A00
	8 m	DD	ZA Rechtecksteckverbinder 9-pol.	Standard	7S3FK083523615A00
	4 m	DD	ZA Rechtecksteckverbinder 9-pol.	High Flex Leder	7S3FH043523615A00
	8 m	DD	ZA Rechtecksteckverbinder 9-pol.	High Flex Leder	7S3FH083523615A00
ABITIG® 24G	4 m	DD	ZA Rechtecksteckverbinder 9-pol.	Standard	7S8SK043523615A00
	8 m	DD	ZA Rechtecksteckverbinder 9-pol.	Standard	7S8SK083523615A00
	4 m	DD	ZA Rechtecksteckverbinder 9-pol.	High Flex Leder	7S8SH043523615A00
	8 m	DD	ZA Rechtecksteckverbinder 9-pol.	High Flex Leder	7S8SH083523615A00
ABITIG® 24G Little	4 m	DD	ZA Rechtecksteckverbinder 9-pol.	High Flex Leder	7L8SH043523615A00
	8 m	DD	ZA Rechtecksteckverbinder 9-pol.	High Flex Leder	7L8SH083523615A00
ABITIG® 200	4 m	DD	ZA Rechtecksteckverbinder 9-pol.	Standard	7T4SK043523615A00
	8 m	DD	ZA Rechtecksteckverbinder 9-pol.	Standard	7T4SK083523615A00
	4 m	DD	ZA Rechtecksteckverbinder 9-pol.	High Flex Leder	7T4SH043523615A00
	8 m	DD	ZA Rechtecksteckverbinder 9-pol.	High Flex Leder	7T4SH083523615A00
ABITIG® 200F	4 m	DD	ZA Rechtecksteckverbinder 9-pol.	Standard	7T4FK043523615A00
	8 m	DD	ZA Rechtecksteckverbinder 9-pol.	Standard	7T4FK083523615A00
	4 m	DD	ZA Rechtecksteckverbinder 9-pol.	High Flex Leder	7T4FH043523615A00
	8 m	DD	ZA Rechtecksteckverbinder 9-pol.	High Flex Leder	7T4FH083523615A00
ABITIG® 150	4 m	DD	ZA Rechtecksteckverbinder 9-pol.	Standard	7T6SK043523615A00
	8 m	DD	ZA Rechtecksteckverbinder 9-pol.	Standard	7T6SK083523615A00
	4 m	DD	ZA Rechtecksteckverbinder 9-pol.	High Flex Leder	7T6SH043523615A00
	8 m	DD	ZA Rechtecksteckverbinder 9-pol.	High Flex Leder	7T6SH083523615A00
ABITIG® 150 Little	4 m	DD	ZA Rechtecksteckverbinder 9-pol.	High Flex Leder	7L6SH043523615A00
	8 m	DD	ZA Rechtecksteckverbinder 9-pol.	High Flex Leder	7L6SH083523615A00
ABITIG® 150F	4 m	DD	ZA Rechtecksteckverbinder 9-pol.	Standard	7T6FK043523615A00
	8 m	DD	ZA Rechtecksteckverbinder 9-pol.	Standard	7T6FK083523615A00
	4 m	DD	ZA Rechtecksteckverbinder 9-pol.	High Flex Leder	7T6FH043523615A00
	8 m	DD	ZA Rechtecksteckverbinder 9-pol.	High Flex Leder	7T6FH083523615A00
ABITIG® 150F Little	4 m	DD	ZA Rechtecksteckverbinder 9-pol.	High Flex Leder	7L6FH043523615A00
	8 m	DD	ZA Rechtecksteckverbinder 9-pol.	High Flex Leder	7L6FH083523615A00

ABITIG® GRIP / ABITIG® GRIP Little-Brennerpreisliste

passend für WIG-Stromquellen des Fabrikates „fronius“ Up/Down



Brennertyp	Länge	Schalterfunktion	maschinenseitiger Anschluss	Schlauchpaketausführung	Bestellnummer
ABITIG® 9	4 m	UD	ZA Rechtecksteckverbinder 9-pol.	Standard	7S1SK046653616A00
	8 m	UD	ZA Rechtecksteckverbinder 9-pol.	Standard	7S1SK086653616A00
	4 m	UD	ZA Rechtecksteckverbinder 9-pol.	High Flex Leder	7S1SH046653616A00
	8 m	UD	ZA Rechtecksteckverbinder 9-pol.	High Flex Leder	7S1SH086653616A00
ABITIG® 9 Little	4 m	UD	ZA Rechtecksteckverbinder 9-pol.	High Flex Leder	7L1SH046653616A00
	8 m	UD	ZA Rechtecksteckverbinder 9-pol.	High Flex Leder	7L1SH086653616A00
ABITIG® 9F	4 m	UD	ZA Rechtecksteckverbinder 9-pol.	Standard	7S1FK046653616A00
	8 m	UD	ZA Rechtecksteckverbinder 9-pol.	Standard	7S1FK086653616A00
	4 m	UD	ZA Rechtecksteckverbinder 9-pol.	High Flex Leder	7S1FH046653616A00
	8 m	UD	ZA Rechtecksteckverbinder 9-pol.	High Flex Leder	7S1FH086653616A00
ABITIG® 9F Little	4 m	UD	ZA Rechtecksteckverbinder 9-pol.	High Flex Leder	7L1FH046653616A00
	8 m	UD	ZA Rechtecksteckverbinder 9-pol.	High Flex Leder	7L1FH086653616A00
ABITIG® 17	4 m	UD	ZA Rechtecksteckverbinder 9-pol.	Standard	7S2SK046653616A00
	8 m	UD	ZA Rechtecksteckverbinder 9-pol.	Standard	7S2SK086653616A00
	4 m	UD	ZA Rechtecksteckverbinder 9-pol.	High Flex Leder	7S2SH046653616A00
	8 m	UD	ZA Rechtecksteckverbinder 9-pol.	High Flex Leder	7S2SH086653616A00
ABITIG® 17 Little	4 m	UD	ZA Rechtecksteckverbinder 9-pol.	High Flex Leder	7L2SH046653616A00
	8 m	UD	ZA Rechtecksteckverbinder 9-pol.	High Flex Leder	7L2SH086653616A00
ABITIG® 17F	4 m	UD	ZA Rechtecksteckverbinder 9-pol.	Standard	7S2FK046653616A00
	8 m	UD	ZA Rechtecksteckverbinder 9-pol.	Standard	7S2FK086653616A00
	4 m	UD	ZA Rechtecksteckverbinder 9-pol.	High Flex Leder	7S2FH046653616A00
	8 m	UD	ZA Rechtecksteckverbinder 9-pol.	High Flex Leder	7S2FH086653616A00
ABITIG® 17F Little	4 m	UD	ZA Rechtecksteckverbinder 9-pol.	High Flex Leder	7L2FH046653616A00
	8 m	UD	ZA Rechtecksteckverbinder 9-pol.	High Flex Leder	7L2FH086653616A00

Technische Änderungen vorbehalten • Verkaufspreise = unverbindliche Preisempfehlung - Angebot freibleibend • © Copyright

ABITIG® GRIP / ABITIG® GRIP Little-Brennerpreisliste

passend für WIG-Stromquellen des Fabrikates „fronius“ Up/Down

Brennertyp	Länge	Schalterfunktion	maschinenseitiger Anschluss	Schlauchpaketausführung	Bestellnummer
ABITIG® 26	4 m	UD	ZA Rechtecksteckverbinder 9-pol.	Standard	7S3SK046653616A00
	8 m	UD	ZA Rechtecksteckverbinder 9-pol.	Standard	7S3SK086653616A00
	4 m	UD	ZA Rechtecksteckverbinder 9-pol.	High Flex Leder	7S3SH046653616A00
	8 m	UD	ZA Rechtecksteckverbinder 9-pol.	High Flex Leder	7S3SH086653616A00
ABITIG® 26F	4 m	UD	ZA Rechtecksteckverbinder 9-pol.	Standard	7S3FK046653616A00
	8 m	UD	ZA Rechtecksteckverbinder 9-pol.	Standard	7S3FK086653616A00
	4 m	UD	ZA Rechtecksteckverbinder 9-pol.	High Flex Leder	7S3FH046653616A00
	8 m	UD	ZA Rechtecksteckverbinder 9-pol.	High Flex Leder	7S3FH086653616A00
ABITIG® 24G	4 m	UD	ZA Rechtecksteckverbinder 9-pol.	Standard	7S8SK046653616A00
	8 m	UD	ZA Rechtecksteckverbinder 9-pol.	Standard	7S8SK086653616A00
	4 m	UD	ZA Rechtecksteckverbinder 9-pol.	High Flex Leder	7S8SH046653616A00
	8 m	UD	ZA Rechtecksteckverbinder 9-pol.	High Flex Leder	7S8SH086653616A00
ABITIG® 24G Little	4 m	UD	ZA Rechtecksteckverbinder 9-pol.	High Flex Leder	7L8SH046653616A00
	8 m	UD	ZA Rechtecksteckverbinder 9-pol.	High Flex Leder	7L8SH086653616A00
ABITIG® 200	4 m	UD	ZA Rechtecksteckverbinder 9-pol.	Standard	7T4SK046653616A00
	8 m	UD	ZA Rechtecksteckverbinder 9-pol.	Standard	7T4SK086653616A00
	4 m	UD	ZA Rechtecksteckverbinder 9-pol.	High Flex Leder	7T4SH046653616A00
	8 m	UD	ZA Rechtecksteckverbinder 9-pol.	High Flex Leder	7T4SH086653616A00
ABITIG® 200F	4 m	UD	ZA Rechtecksteckverbinder 9-pol.	Standard	7T4FK046653616A00
	8 m	UD	ZA Rechtecksteckverbinder 9-pol.	Standard	7T4FK086653616A00
	4 m	UD	ZA Rechtecksteckverbinder 9-pol.	High Flex Leder	7T4FH046653616A00
	8 m	UD	ZA Rechtecksteckverbinder 9-pol.	High Flex Leder	7T4FH086653616A00
ABITIG® 150	4 m	UD	ZA Rechtecksteckverbinder 9-pol.	Standard	7T6SK046653616A00
	8 m	UD	ZA Rechtecksteckverbinder 9-pol.	Standard	7T6SK086653616A00
	4 m	UD	ZA Rechtecksteckverbinder 9-pol.	High Flex Leder	7T6SH046653616A00
	8 m	UD	ZA Rechtecksteckverbinder 9-pol.	High Flex Leder	7T6SH086653616A00
ABITIG® 150 Little	4 m	UD	ZA Rechtecksteckverbinder 9-pol.	High Flex Leder	7L6SH046653616A00
	8 m	UD	ZA Rechtecksteckverbinder 9-pol.	High Flex Leder	7L6SH086653616A00
ABITIG® 150F	4 m	UD	ZA Rechtecksteckverbinder 9-pol.	Standard	7T6FK046653616A00
	8 m	UD	ZA Rechtecksteckverbinder 9-pol.	Standard	7T6FK086653616A00
	4 m	UD	ZA Rechtecksteckverbinder 9-pol.	High Flex Leder	7T6FH046653616A00
	8 m	UD	ZA Rechtecksteckverbinder 9-pol.	High Flex Leder	7T6FH086653616A00
ABITIG® 150F Little	4 m	UD	ZA Rechtecksteckverbinder 9-pol.	High Flex Leder	7L6FH046653616A00
	8 m	UD	ZA Rechtecksteckverbinder 9-pol.	High Flex Leder	7L6FH086653616A00

ABITIG® GRIP / ABITIG® GRIP Little-Brennerpreisliste

passend für WIG-Stromquellen des Fabrikates „fronius“

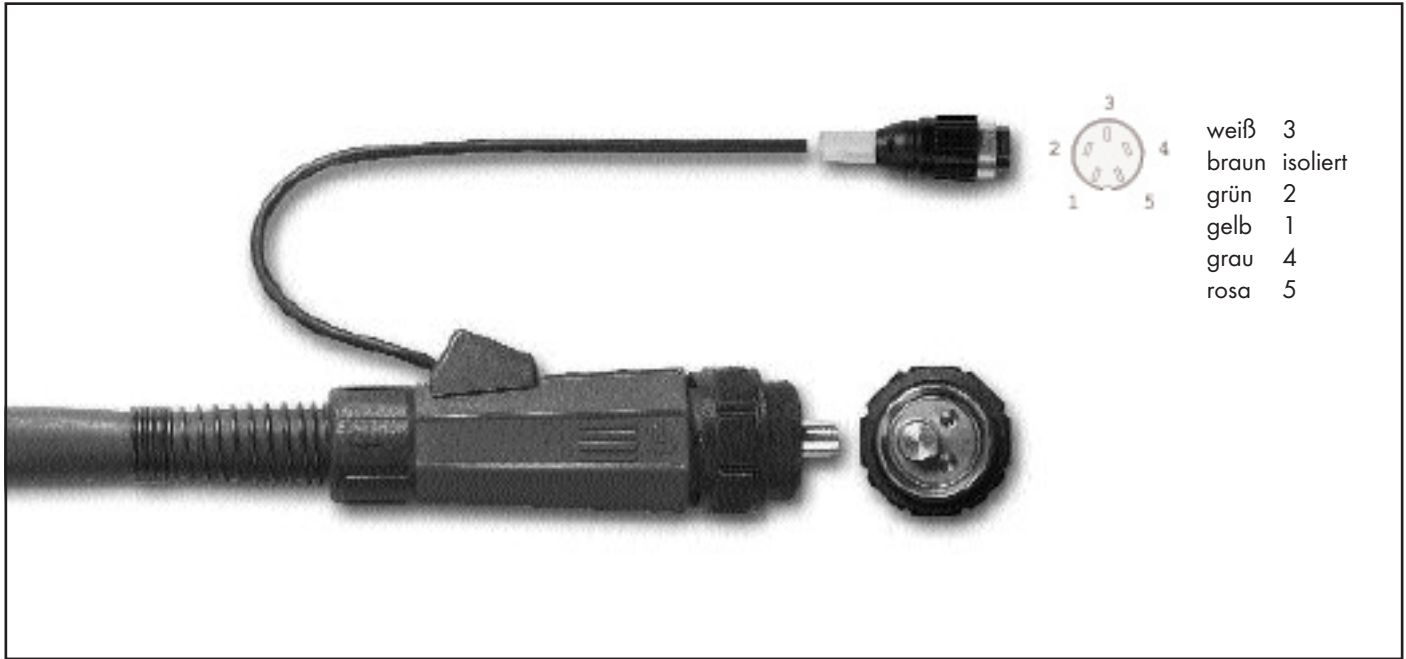

Brennertyp	Länge	Schalterfunktion	maschinenseitiger Anschluss	Schlauchpaketausführung	Bestellnummer
ABITIG® 9	4 m	UD	ZA - GZ Tuchel 5-pol.	Standard	7S1SK043650363B00
	8 m	UD	ZA - GZ Tuchel 5-pol.	Standard	7S1SK083650363B00
	4 m	UD	ZA - GZ Tuchel 5-pol.	High Flex Leder	7S1SH043650363B00
	8 m	UD	ZA - GZ Tuchel 5-pol.	High Flex Leder	7S1SH083650363B00
ABITIG® 9 Little	4 m	UD	ZA - GZ Tuchel 5-pol.	High Flex Leder	7L1SH043650363B00
	8 m	UD	ZA - GZ Tuchel 5-pol.	High Flex Leder	7L1SH083650363B00
ABITIG® 9F	4 m	UD	ZA - GZ Tuchel 5-pol.	Standard	7S1FK043650363B00
	8 m	UD	ZA - GZ Tuchel 5-pol.	Standard	7S1FK083650363B00
	4 m	UD	ZA - GZ Tuchel 5-pol.	High Flex Leder	7S1FH043650363B00
	8 m	UD	ZA - GZ Tuchel 5-pol.	High Flex Leder	7S1FH083650363B00
ABITIG® 9F Little	4 m	UD	ZA - GZ Tuchel 5-pol.	High Flex Leder	7L1FH043650363B00
	8 m	UD	ZA - GZ Tuchel 5-pol.	High Flex Leder	7L1FH083650363B00
ABITIG® 17	4 m	UD	ZA - GZ Tuchel 5-pol.	Standard	7S2SK043650363B00
	8 m	UD	ZA - GZ Tuchel 5-pol.	Standard	7S2SK083650363B00
	4 m	UD	ZA - GZ Tuchel 5-pol.	High Flex Leder	7S2SH043650363B00
	8 m	UD	ZA - GZ Tuchel 5-pol.	High Flex Leder	7S2SH083650363B00
ABITIG® 17 Little	4 m	UD	ZA - GZ Tuchel 5-pol.	High Flex Leder	7L2SH043650363B00
	8 m	UD	ZA - GZ Tuchel 5-pol.	High Flex Leder	7L2SH083650363B00
ABITIG® 17F	4 m	UD	ZA - GZ Tuchel 5-pol.	Standard	7S2FK043650363B00
	8 m	UD	ZA - GZ Tuchel 5-pol.	Standard	7S2FK083650363B00
	4 m	UD	ZA - GZ Tuchel 5-pol.	High Flex Leder	7S2FH043650363B00
	8 m	UD	ZA - GZ Tuchel 5-pol.	High Flex Leder	7S2FH083650363B00
ABITIG® 17F Little	4 m	UD	ZA - GZ Tuchel 5-pol.	High Flex Leder	7L2FH043650363B00
	8 m	UD	ZA - GZ Tuchel 5-pol.	High Flex Leder	7L2FH083650363B00

Technische Änderungen vorbehalten • Verkaufspreise = unverbindliche Preisempfehlung - Angebot freibleibend • © Copyright

ABITIG® GRIP / ABITIG® GRIP Little-Brennerpreisliste

passend für WIG-Stromquellen des Fabrikates „fronius“

Brennertyp	Länge	Schalterfunktion	maschinenseitiger Anschluss	Schlauchpaketausführung	Bestellnummer
ABITIG® 26	4 m	UD	ZA - GZ Tuchel 5-pol.	Standard	7S3SK043650363B00
	8 m	UD	ZA - GZ Tuchel 5-pol.	Standard	7S3SK083650363B00
	4 m	UD	ZA - GZ Tuchel 5-pol.	High Flex Leder	7S3SH043650363B00
	8 m	UD	ZA - GZ Tuchel 5-pol.	High Flex Leder	7S3SH083650363B00
ABITIG® 26F	4 m	UD	ZA - GZ Tuchel 5-pol.	Standard	7S3FK043650363B00
	8 m	UD	ZA - GZ Tuchel 5-pol.	Standard	7S3FK083650363B00
	4 m	UD	ZA - GZ Tuchel 5-pol.	High Flex Leder	7S3FH043650363B00
	8 m	UD	ZA - GZ Tuchel 5-pol.	High Flex Leder	7S3FH083650363B00
ABITIG® 24G	4 m	UD	ZA - GZ Tuchel 5-pol.	Standard	7S8SK043650363B00
	8 m	UD	ZA - GZ Tuchel 5-pol.	Standard	7S8SK083650363B00
	4 m	UD	ZA - GZ Tuchel 5-pol.	High Flex Leder	7S8SH043650363B00
	8 m	UD	ZA - GZ Tuchel 5-pol.	High Flex Leder	7S8SH083650363B00
ABITIG® 24G Little	4 m	UD	ZA - GZ Tuchel 5-pol.	High Flex Leder	7L8SH043650363B00
	8 m	UD	ZA - GZ Tuchel 5-pol.	High Flex Leder	7L8SH083650363B00
ABITIG® 200	4 m	UD	ZA - GZ Tuchel 5-pol.	Standard	7T4SK043650363B00
	8 m	UD	ZA - GZ Tuchel 5-pol.	Standard	7T4SK083650363B00
	4 m	UD	ZA - GZ Tuchel 5-pol.	High Flex Leder	7T4SH043650363B00
	8 m	UD	ZA - GZ Tuchel 5-pol.	High Flex Leder	7T4SH083650363B00
ABITIG® 200F	4 m	UD	ZA - GZ Tuchel 5-pol.	Standard	7T4FK043650363B00
	8 m	UD	ZA - GZ Tuchel 5-pol.	Standard	7T4FK083650363B00
	4 m	UD	ZA - GZ Tuchel 5-pol.	High Flex Leder	7T4FH043650363B00
	8 m	UD	ZA - GZ Tuchel 5-pol.	High Flex Leder	7T4FH083650363B00
ABITIG® 150	4 m	UD	ZA - GZ Tuchel 5-pol.	Standard	7T6SK043650363B00
	8 m	UD	ZA - GZ Tuchel 5-pol.	Standard	7T6SK083650363B00
	4 m	UD	ZA - GZ Tuchel 5-pol.	High Flex Leder	7T6SH043650363B00
	8 m	UD	ZA - GZ Tuchel 5-pol.	High Flex Leder	7T6SH083650363B00
ABITIG® 150 Little	4 m	UD	ZA - GZ Tuchel 5-pol.	High Flex Leder	7L6SH043650363B00
	8 m	UD	ZA - GZ Tuchel 5-pol.	High Flex Leder	7L6SH083650363B00
ABITIG® 150F	4 m	UD	ZA - GZ Tuchel 5-pol.	Standard	7T6FK043650363B00
	8 m	UD	ZA - GZ Tuchel 5-pol.	Standard	7T6FK083650363B00
	4 m	UD	ZA - GZ Tuchel 5-pol.	High Flex Leder	7T6FH043650363B00
	8 m	UD	ZA - GZ Tuchel 5-pol.	High Flex Leder	7T6FH083650363B00
ABITIG® 150F Little	4 m	UD	ZA - GZ Tuchel 5-pol.	High Flex Leder	7L6FH043650363B00
	8 m	UD	ZA - GZ Tuchel 5-pol.	High Flex Leder	7L6FH083650363B00

ABITIG® GRIP / ABITIG® GRIP Little-Brennerpreisliste

passend für WIG-Stromquellen des Fabrikates „fronius“

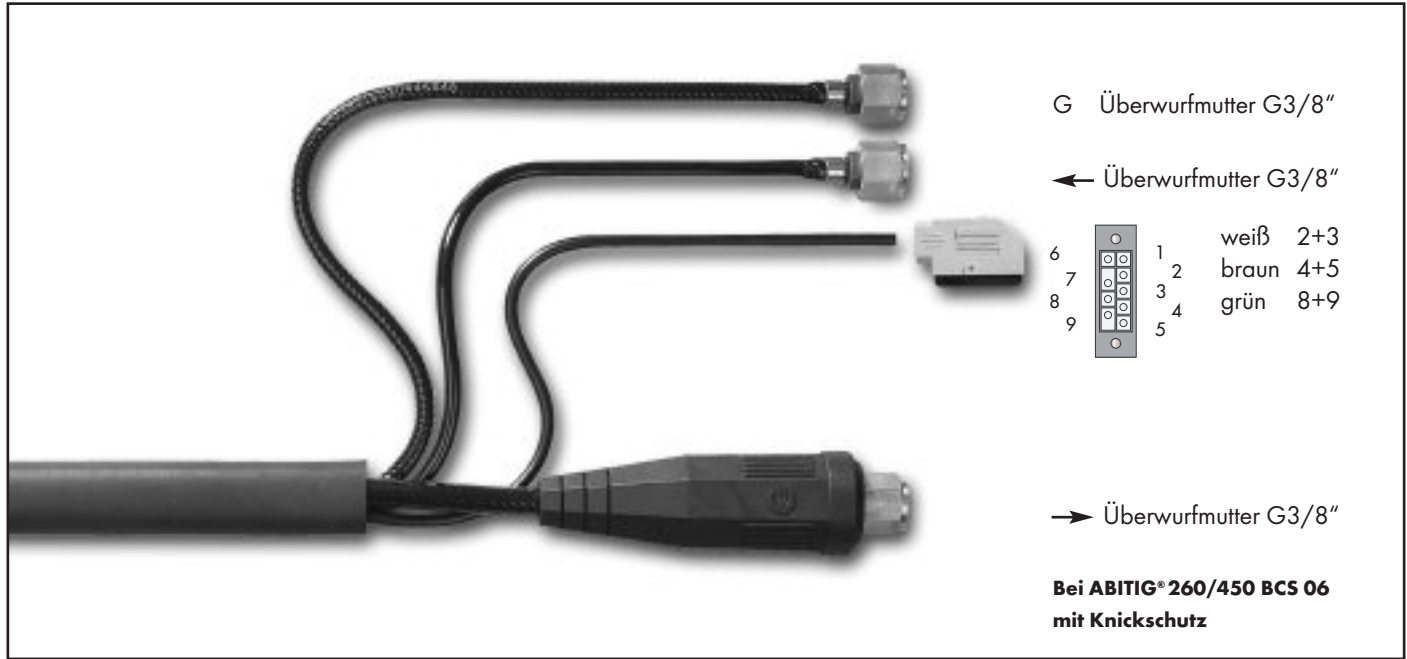

Brennertyp	Länge	Schalterfunktion	maschinenseitiger Anschluss	Schlauchpaketausführung	Bestellnummer
ABITIG® 18	4 m	DD	EA Rechtecksteckverbinder 9-pol.	Standard	7S4SK043520615A14
	8 m	DD	EA Rechtecksteckverbinder 9-pol.	Standard	7S4SK083520615A14
	4 m	DD	EA Rechtecksteckverbinder 9-pol.	High Flex Leder	7S4SH043520615A14
	8 m	DD	EA Rechtecksteckverbinder 9-pol.	High Flex Leder	7S4SH083520615A14
ABITIG® 18F	4 m	DD	EA Rechtecksteckverbinder 9-pol.	Standard	7S4FK043520615A14
	8 m	DD	EA Rechtecksteckverbinder 9-pol.	Standard	7S4FK083520615A14
	4 m	DD	EA Rechtecksteckverbinder 9-pol.	High Flex Leder	7S4FH043520615A14
	8 m	DD	EA Rechtecksteckverbinder 9-pol.	High Flex Leder	7S4FH083520615A14
ABITIG® 20	4 m	DD	EA Rechtecksteckverbinder 9-pol.	Standard	7S5SK043520615A14
	8 m	DD	EA Rechtecksteckverbinder 9-pol.	Standard	7S5SK083520615A14
	4 m	DD	EA Rechtecksteckverbinder 9-pol.	High Flex Leder	7S5SH043520615A14
	8 m	DD	EA Rechtecksteckverbinder 9-pol.	High Flex Leder	7S5SH083520615A14
ABITIG® 20 Little	4 m	DD	EA Rechtecksteckverbinder 9-pol.	High Flex Leder	7L5SH043520615A14
	8 m	DD	EA Rechtecksteckverbinder 9-pol.	High Flex Leder	7L5SH083520615A14
ABITIG® 20F	4 m	DD	EA Rechtecksteckverbinder 9-pol.	Standard	7S5FK043520615A14
	8 m	DD	EA Rechtecksteckverbinder 9-pol.	Standard	7S5FK083520615A14
	4 m	DD	EA Rechtecksteckverbinder 9-pol.	High Flex Leder	7S5FH043520615A14
	8 m	DD	EA Rechtecksteckverbinder 9-pol.	High Flex Leder	7S5FH083520615A14
ABITIG® 20F Little	4 m	DD	EA Rechtecksteckverbinder 9-pol.	High Flex Leder	7L5FH043520615A14
	8 m	DD	EA Rechtecksteckverbinder 9-pol.	High Flex Leder	7L5FH083520615A14

Technische Änderungen vorbehalten • Verkaufspreise = unverbindliche Preisempfehlung - Angebot freibleibend • © Copyright

ABITIG® GRIP / ABITIG® GRIP Little-Brennerpreisliste

passend für WIG-Stromquellen des Fabrikates „fronius“

Brennertyp	Länge	Schalterfunktion	maschinenseitiger Anschluss	Schlauchpaketausführung	Bestellnummer
ABITIG® 12-1	4 m	DD	EA Rechtecksteckverbinder 9-pol.	Standard	7S6SK043520615A14
	8 m	DD	EA Rechtecksteckverbinder 9-pol.	Standard	7S6SK083520615A14
	4 m	DD	EA Rechtecksteckverbinder 9-pol.	High Flex Leder	7S6SH043520615A14
	8 m	DD	EA Rechtecksteckverbinder 9-pol.	High Flex Leder	7S6SH083520615A14
ABITIG® 18SC	4 m	DD	EA Rechtecksteckverbinder 9-pol.	Standard	7S7SK043520615A14
	8 m	DD	EA Rechtecksteckverbinder 9-pol.	Standard	7S7SK083520615A14
	4 m	DD	EA Rechtecksteckverbinder 9-pol.	High Flex Leder	7S7SH043520615A14
	8 m	DD	EA Rechtecksteckverbinder 9-pol.	High Flex Leder	7S7SH083520615A14
ABITIG® 24W	4 m	DD	EA Rechtecksteckverbinder 9-pol.	Standard	7S9SK043520615A14
	8 m	DD	EA Rechtecksteckverbinder 9-pol.	Standard	7S9SK083520615A14
	4 m	DD	EA Rechtecksteckverbinder 9-pol.	High Flex Leder	7S9SH043520615A14
	8 m	DD	EA Rechtecksteckverbinder 9-pol.	High Flex Leder	7S9SH083520615A14
ABITIG® 24W Little	4 m	DD	EA Rechtecksteckverbinder 9-pol.	High Flex Leder	7L9SH043520615A14
	8 m	DD	EA Rechtecksteckverbinder 9-pol.	High Flex Leder	7L9SH083520615A14
ABITIG® 450W	4 m	DD	EA Rechtecksteckverbinder 9-pol.	Standard	7T5SK043520615A14
	8 m	DD	EA Rechtecksteckverbinder 9-pol.	Standard	7T5SK083520615A14
	4 m	DD	EA Rechtecksteckverbinder 9-pol.	High Flex Leder	7T5SH043520615A14
	8 m	DD	EA Rechtecksteckverbinder 9-pol.	High Flex Leder	7T5SH083520615A14
ABITIG® 260W	4 m	DD	EA Rechtecksteckverbinder 9-pol.	Standard	7T7SK043520615A14
	8 m	DD	EA Rechtecksteckverbinder 9-pol.	Standard	7T7SK083520615A14
	4 m	DD	EA Rechtecksteckverbinder 9-pol.	High Flex Leder	7T7SH043520615A14
	8 m	DD	EA Rechtecksteckverbinder 9-pol.	High Flex Leder	7T7SH083520615A14
ABITIG® 260W Little	4 m	DD	EA Rechtecksteckverbinder 9-pol.	High Flex Leder	7L7SH043520615A14
	8 m	DD	EA Rechtecksteckverbinder 9-pol.	High Flex Leder	7L7SH083520615A14
ABITIG® 450W SC	4 m	DD	EA Rechtecksteckverbinder 9-pol.	Standard	
	8 m	DD	EA Rechtecksteckverbinder 9-pol.	Standard	
	4 m	DD	EA Rechtecksteckverbinder 9-pol.	High Flex Leder	7T8SH043520615A14
	8 m	DD	EA Rechtecksteckverbinder 9-pol.	High Flex Leder	7T8SH083520615A14

ABITIG® GRIP / ABITIG® GRIP Little-Brennerpreisliste

passend für WIG-Stromquellen des Fabrikates „fronius“

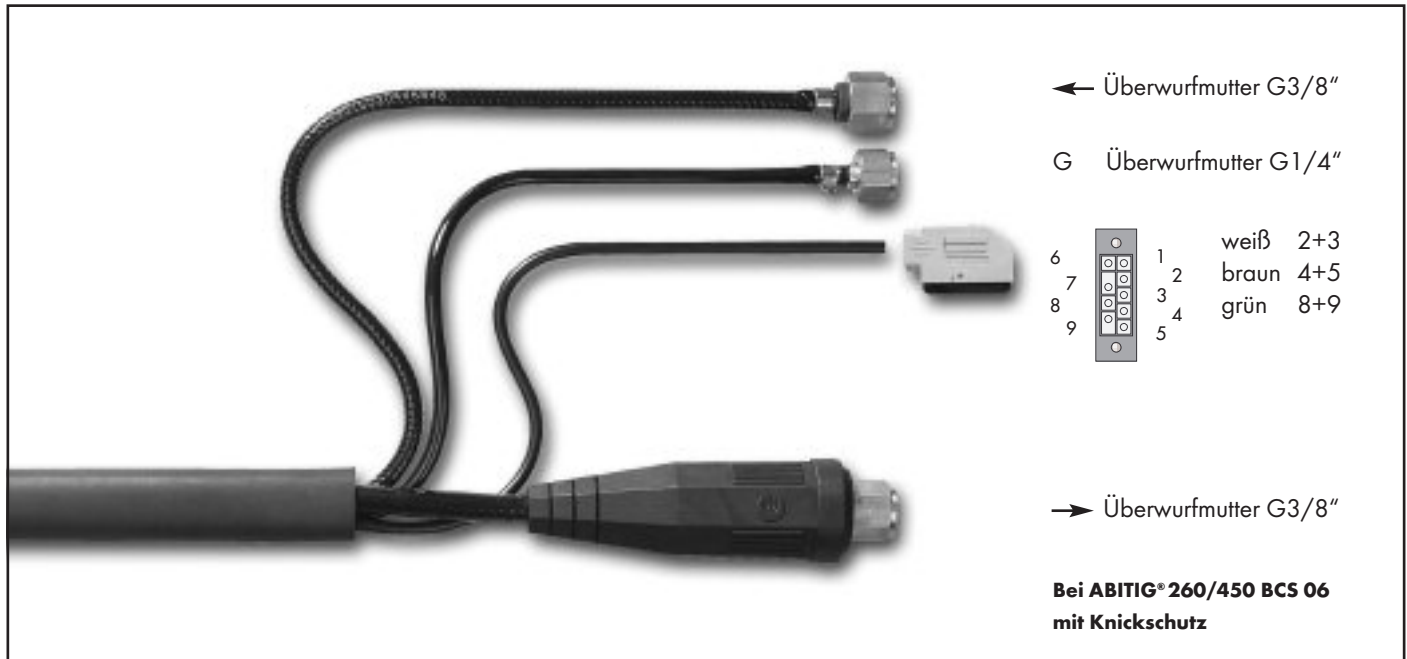

Brennertyp	Länge	Schalterfunktion	maschinenseitiger Anschluss	Schlauchpaketausführung	Bestellnummer
ABITIG® 18	4 m	DD	EA Rechtecksteckverbinder 9-pol.	Standard	7S4SK043520615A15
	8 m	DD	EA Rechtecksteckverbinder 9-pol.	Standard	7S4SK083520615A15
	4 m	DD	EA Rechtecksteckverbinder 9-pol.	High Flex Leder	7S4SH043520615A15
	8 m	DD	EA Rechtecksteckverbinder 9-pol.	High Flex Leder	7S4SH083520615A15
ABITIG® 18F	4 m	DD	EA Rechtecksteckverbinder 9-pol.	Standard	7S4FK043520615A15
	8 m	DD	EA Rechtecksteckverbinder 9-pol.	Standard	7S4FK083520615A15
	4 m	DD	EA Rechtecksteckverbinder 9-pol.	High Flex Leder	7S4FH043520615A15
	8 m	DD	EA Rechtecksteckverbinder 9-pol.	High Flex Leder	7S4FH083520615A15
ABITIG® 20	4 m	DD	EA Rechtecksteckverbinder 9-pol.	Standard	7S5SK043520615A15
	8 m	DD	EA Rechtecksteckverbinder 9-pol.	Standard	7S5SK083520615A15
	4 m	DD	EA Rechtecksteckverbinder 9-pol.	High Flex Leder	7S5SH043520615A15
	8 m	DD	EA Rechtecksteckverbinder 9-pol.	High Flex Leder	7S5SH083520615A15
ABITIG® 20 Little	4 m	DD	EA Rechtecksteckverbinder 9-pol.	High Flex Leder	7L5SH043520615A15
	8 m	DD	EA Rechtecksteckverbinder 9-pol.	High Flex Leder	7L5SH083520615A15
ABITIG® 20F	4 m	DD	EA Rechtecksteckverbinder 9-pol.	Standard	7S5FK043520615A15
	8 m	DD	EA Rechtecksteckverbinder 9-pol.	Standard	7S5FK083520615A15
	4 m	DD	EA Rechtecksteckverbinder 9-pol.	High Flex Leder	7S5FH043520615A15
	8 m	DD	EA Rechtecksteckverbinder 9-pol.	High Flex Leder	7S5FH083520615A15
ABITIG® 20F Little	4 m	DD	EA Rechtecksteckverbinder 9-pol.	High Flex Leder	7L5FH043520615A15
	8 m	DD	EA Rechtecksteckverbinder 9-pol.	High Flex Leder	7L5FH083520615A15

Technische Änderungen vorbehalten • Verkaufspreise = unverbindliche Preisempfehlung - Angebot freibleibend • © Copyright

ABITIG® GRIP / ABITIG® GRIP Little-Brennerpreisliste

passend für WIG-Stromquellen des Fabrikates „fronius“

Brennertyp	Länge	Schalterfunktion	maschinenseitiger Anschluss	Schlauchpaketausführung	Bestellnummer
ABITIG® 12-1	4 m	DD	EA Rechtecksteckverbinder 9-pol.	Standard	7S6SK043520615A15
	8 m	DD	EA Rechtecksteckverbinder 9-pol.	Standard	7S6SK083520615A15
	4 m	DD	EA Rechtecksteckverbinder 9-pol.	High Flex Leder	7S6SH043520615A15
	8 m	DD	EA Rechtecksteckverbinder 9-pol.	High Flex Leder	7S6SH083520615A15
ABITIG® 18SC	4 m	DD	EA Rechtecksteckverbinder 9-pol.	Standard	7S7SK043520615A15
	8 m	DD	EA Rechtecksteckverbinder 9-pol.	Standard	7S7SK083520615A15
	4 m	DD	EA Rechtecksteckverbinder 9-pol.	High Flex Leder	7S7SH043520615A15
	8 m	DD	EA Rechtecksteckverbinder 9-pol.	High Flex Leder	7S7SH083520615A15
ABITIG® 24W	4 m	DD	EA Rechtecksteckverbinder 9-pol.	Standard	7S9SK043520615A15
	8 m	DD	EA Rechtecksteckverbinder 9-pol.	Standard	7S9SK083520615A15
	4 m	DD	EA Rechtecksteckverbinder 9-pol.	High Flex Leder	7S9SH043520615A15
	8 m	DD	EA Rechtecksteckverbinder 9-pol.	High Flex Leder	7S9SH083520615A15
ABITIG® 24W Little	4 m	DD	EA Rechtecksteckverbinder 9-pol.	High Flex Leder	7L9SH043520615A15
	8 m	DD	EA Rechtecksteckverbinder 9-pol.	High Flex Leder	7L9SH083520615A15
ABITIG® 450W	4 m	DD	EA Rechtecksteckverbinder 9-pol.	Standard	7T5SK043520615A15
	8 m	DD	EA Rechtecksteckverbinder 9-pol.	Standard	7T5SK083520615A15
	4 m	DD	EA Rechtecksteckverbinder 9-pol.	High Flex Leder	7T5SH043520615A15
	8 m	DD	EA Rechtecksteckverbinder 9-pol.	High Flex Leder	7T5SH083520615A15
ABITIG® 260W	4 m	DD	EA Rechtecksteckverbinder 9-pol.	Standard	7T7SK043520615A15
	8 m	DD	EA Rechtecksteckverbinder 9-pol.	Standard	7T7SK083520615A15
	4 m	DD	EA Rechtecksteckverbinder 9-pol.	High Flex Leder	7T7SH043520615A15
	8 m	DD	EA Rechtecksteckverbinder 9-pol.	High Flex Leder	7T7SH083520615A15
ABITIG® 260W Little	4 m	DD	EA Rechtecksteckverbinder 9-pol.	High Flex Leder	7L7SH043520615A15
	8 m	DD	EA Rechtecksteckverbinder 9-pol.	High Flex Leder	7L7SH083520615A15
ABITIG® 450W SC	4 m	DD	EA Rechtecksteckverbinder 9-pol.	Standard	
	8 m	DD	EA Rechtecksteckverbinder 9-pol.	Standard	
	4 m	DD	EA Rechtecksteckverbinder 9-pol.	High Flex Leder	7T8SH043520615A15
	8 m	DD	EA Rechtecksteckverbinder 9-pol.	High Flex Leder	7T8SH083520615A15

ABITIG® GRIP / ABITIG® GRIP Little-Brennerpreisliste

passend für WIG-Stromquellen des Fabrikates „fronius“ Up/Down

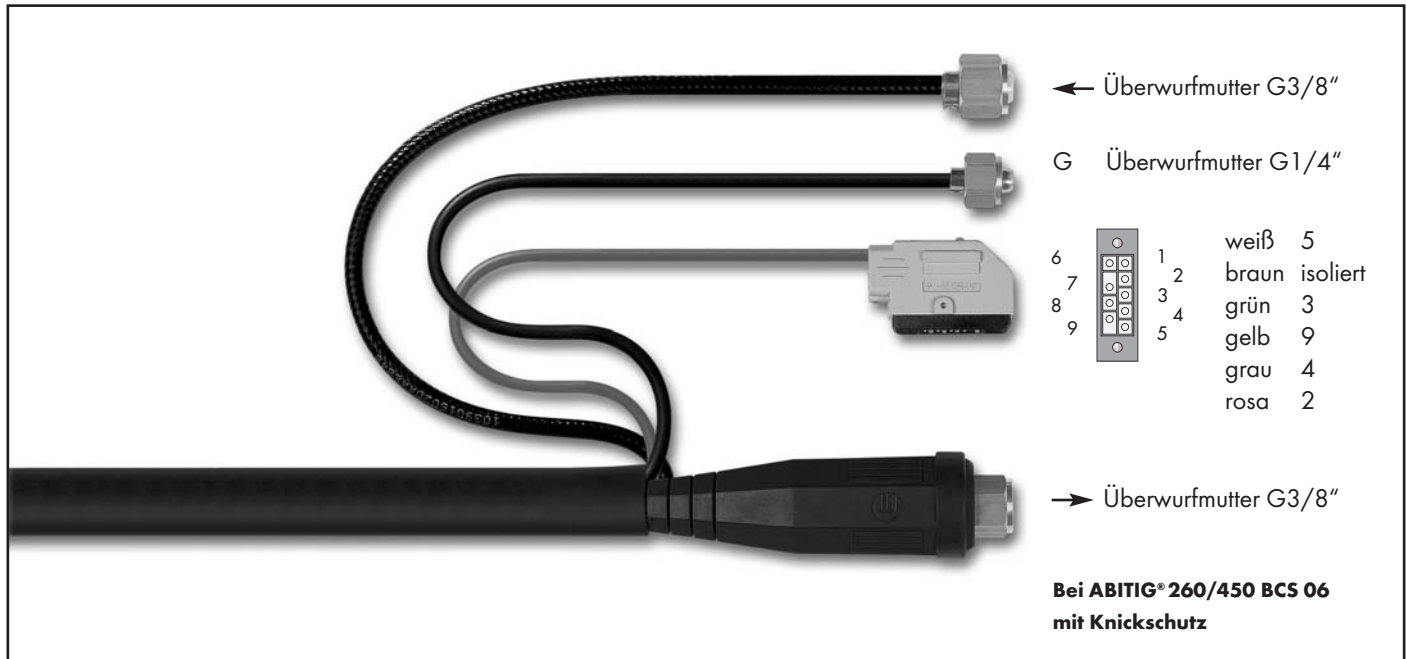

Brennertyp	Länge	Schalterfunktion	maschinenseitiger Anschluss	Schlauchpaketausführung	Bestellnummer
ABITIG® 18	4 m	UD	EA Rechtecksteckverbinder 9-pol.	Standard	7S4SK046650616A15
	8 m	UD	EA Rechtecksteckverbinder 9-pol.	Standard	7S4SK086650616A15
	4 m	UD	EA Rechtecksteckverbinder 9-pol.	High Flex Leder	7S4SH046650616A15
	8 m	UD	EA Rechtecksteckverbinder 9-pol.	High Flex Leder	7S4SH086650616A15
ABITIG® 18F	4 m	UD	EA Rechtecksteckverbinder 9-pol.	Standard	7S4FK046650616A15
	8 m	UD	EA Rechtecksteckverbinder 9-pol.	Standard	7S4FK086650616A15
	4 m	UD	EA Rechtecksteckverbinder 9-pol.	High Flex Leder	7S4FH046650616A15
	8 m	UD	EA Rechtecksteckverbinder 9-pol.	High Flex Leder	7S4FH086650616A15
ABITIG® 20	4 m	UD	EA Rechtecksteckverbinder 9-pol.	Standard	7S5SK046650616A15
	8 m	UD	EA Rechtecksteckverbinder 9-pol.	Standard	7S5SK086650616A15
	4 m	UD	EA Rechtecksteckverbinder 9-pol.	High Flex Leder	7S5SH046650616A15
	8 m	UD	EA Rechtecksteckverbinder 9-pol.	High Flex Leder	7S5SH086650616A15
ABITIG® 20 Little	4 m	UD	EA Rechtecksteckverbinder 9-pol.	High Flex Leder	7L5SH046650616A15
	8 m	UD	EA Rechtecksteckverbinder 9-pol.	High Flex Leder	7L5SH086650616A15
ABITIG® 20F	4 m	UD	EA Rechtecksteckverbinder 9-pol.	Standard	7S5FK046650616A15
	8 m	UD	EA Rechtecksteckverbinder 9-pol.	Standard	7S5FK086650616A15
	4 m	UD	EA Rechtecksteckverbinder 9-pol.	High Flex Leder	7S5FH046650616A15
	8 m	UD	EA Rechtecksteckverbinder 9-pol.	High Flex Leder	7S5FH086650616A15
ABITIG® 20F Little	4 m	UD	EA Rechtecksteckverbinder 9-pol.	High Flex Leder	7L5FH046650616A15
	8 m	UD	EA Rechtecksteckverbinder 9-pol.	High Flex Leder	7L5FH086650616A15

Technische Änderungen vorbehalten • Verkaufspreise = unverbindliche Preisempfehlung - Angebot freibleibend • © Copyright

ABITIG® GRIP / ABITIG® GRIP Little-Brennerpreisliste

passend für WIG-Stromquellen des Fabrikates „fronius“ Up/Down

Brennertyp	Länge	Schalterfunktion	maschinenseitiger Anschluss	Schlauchpaketausführung	Bestellnummer
ABITIG® 12-1	4 m	UD	EA Rechtecksteckverbinder 9-pol.	Standard	7S6SK046650616A15
	8 m	UD	EA Rechtecksteckverbinder 9-pol.	Standard	7S6SK086650616A15
	4 m	UD	EA Rechtecksteckverbinder 9-pol.	High Flex Leder	7S6SH046650616A15
	8 m	UD	EA Rechtecksteckverbinder 9-pol.	High Flex Leder	7S6SH086650616A15
ABITIG® 18SC	4 m	UD	EA Rechtecksteckverbinder 9-pol.	Standard	7S7SK046650616A15
	8 m	UD	EA Rechtecksteckverbinder 9-pol.	Standard	7S7SK086650616A15
	4 m	UD	EA Rechtecksteckverbinder 9-pol.	High Flex Leder	7S7SH046650616A15
	8 m	UD	EA Rechtecksteckverbinder 9-pol.	High Flex Leder	7S7SH086650616A15
ABITIG® 24W	4 m	UD	EA Rechtecksteckverbinder 9-pol.	Standard	7S9SK046650616A15
	8 m	UD	EA Rechtecksteckverbinder 9-pol.	Standard	7S9SK086650616A15
	4 m	UD	EA Rechtecksteckverbinder 9-pol.	High Flex Leder	7S9SH046650616A15
	8 m	UD	EA Rechtecksteckverbinder 9-pol.	High Flex Leder	7S9SH086650616A15
ABITIG® 24W Little	4 m	UD	EA Rechtecksteckverbinder 9-pol.	High Flex Leder	7L9SH046650616A15
	8 m	UD	EA Rechtecksteckverbinder 9-pol.	High Flex Leder	7L9SH086650616A15
ABITIG® 450W	4 m	UD	EA Rechtecksteckverbinder 9-pol.	Standard	7T5SK046650616A15
	8 m	UD	EA Rechtecksteckverbinder 9-pol.	Standard	7T5SK086650616A15
	4 m	UD	EA Rechtecksteckverbinder 9-pol.	High Flex Leder	7T5SH046650616A15
	8 m	UD	EA Rechtecksteckverbinder 9-pol.	High Flex Leder	7T5SH086650616A15
ABITIG® 260W	4 m	UD	EA Rechtecksteckverbinder 9-pol.	Standard	7T7SK046650616A15
	8 m	UD	EA Rechtecksteckverbinder 9-pol.	Standard	7T7SK086650616A15
	4 m	UD	EA Rechtecksteckverbinder 9-pol.	High Flex Leder	7T7SH046650616A15
	8 m	UD	EA Rechtecksteckverbinder 9-pol.	High Flex Leder	7T7SH086650616A15
ABITIG® 260W Little	4 m	UD	EA Rechtecksteckverbinder 9-pol.	High Flex Leder	7L7SH046650616A15
	8 m	UD	EA Rechtecksteckverbinder 9-pol.	High Flex Leder	7L7SH086650616A15
ABITIG® 450W SC	4 m	UD	EA Rechtecksteckverbinder 9-pol.	Standard	
	8 m	UD	EA Rechtecksteckverbinder 9-pol.	Standard	
	4 m	UD	EA Rechtecksteckverbinder 9-pol.	High Flex Leder	7T8SH046650616A15
	8 m	UD	EA Rechtecksteckverbinder 9-pol.	High Flex Leder	7T8SH086650616A15

ABITIG® GRIP / ABITIG® GRIP Little-Brennerpreisliste

passend für WIG-Stromquellen des Fabrikates „fronius“

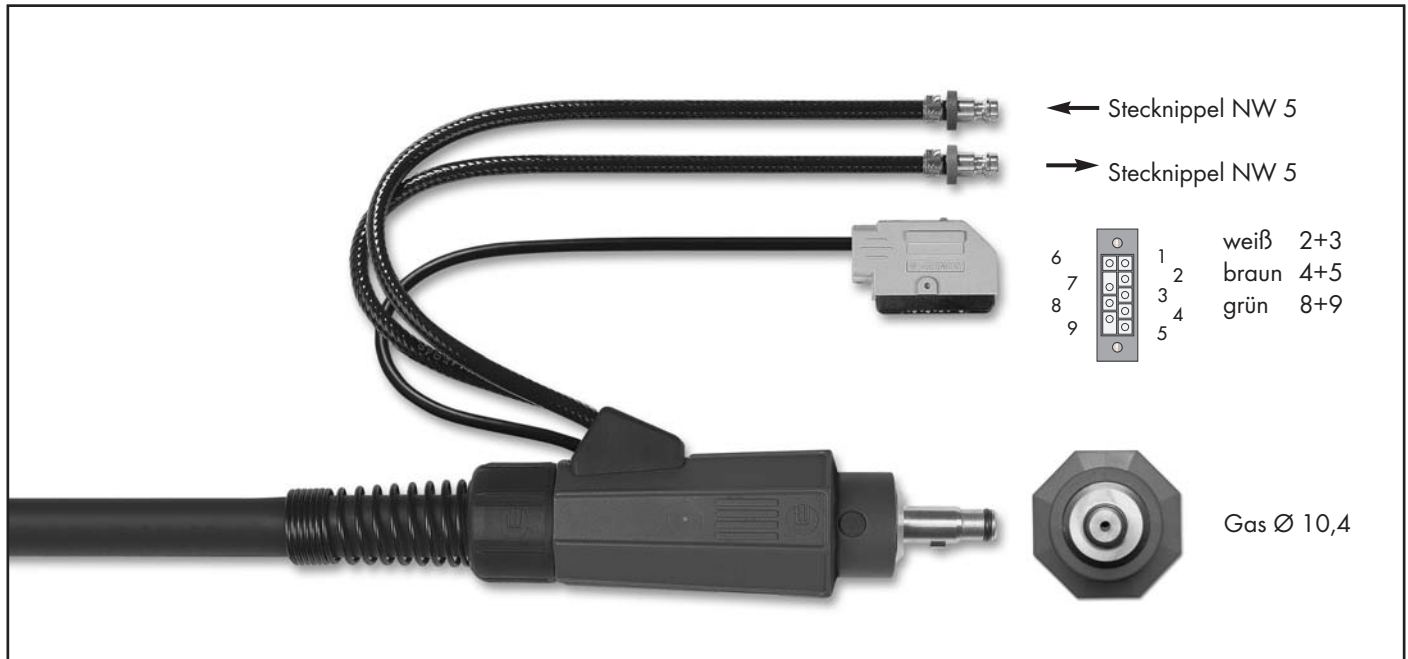

Brennertyp	Länge	Schalterfunktion	maschinenseitiger Anschluss	Schlauchpaketausführung	Bestellnummer
ABITIG® 18	4 m	DD	ZA Rechtecksteckverbinder 9-pol.	Standard	7S4SK043523615A12
	8 m	DD	ZA Rechtecksteckverbinder 9-pol.	Standard	7S4SK083523615A12
	4 m	DD	ZA Rechtecksteckverbinder 9-pol.	High Flex Leder	7S4SH043523615A12
	8 m	DD	ZA Rechtecksteckverbinder 9-pol.	High Flex Leder	7S4SH083523615A12
ABITIG® 18F	4 m	DD	ZA Rechtecksteckverbinder 9-pol.	Standard	7S4FK043523615A12
	8 m	DD	ZA Rechtecksteckverbinder 9-pol.	Standard	7S4FK083523615A12
	4 m	DD	ZA Rechtecksteckverbinder 9-pol.	High Flex Leder	7S4FH043523615A12
	8 m	DD	ZA Rechtecksteckverbinder 9-pol.	High Flex Leder	7S4FH083523615A12
ABITIG® 20	4 m	DD	ZA Rechtecksteckverbinder 9-pol.	Standard	7S5SK043523615A12
	8 m	DD	ZA Rechtecksteckverbinder 9-pol.	Standard	7S5SK083523615A12
	4 m	DD	ZA Rechtecksteckverbinder 9-pol.	High Flex Leder	7S5SH043523615A12
	8 m	DD	ZA Rechtecksteckverbinder 9-pol.	High Flex Leder	7S5SH083523615A12
ABITIG® 20 Little	4 m	DD	ZA Rechtecksteckverbinder 9-pol.	High Flex Leder	7L5SH043523615A12
	8 m	DD	ZA Rechtecksteckverbinder 9-pol.	High Flex Leder	7L5SH083523615A12
ABITIG® 20F	4 m	DD	ZA Rechtecksteckverbinder 9-pol.	Standard	7S5FK043523615A12
	8 m	DD	ZA Rechtecksteckverbinder 9-pol.	Standard	7S5FK083523615A12
	4 m	DD	ZA Rechtecksteckverbinder 9-pol.	High Flex Leder	7S5FH043523615A12
	8 m	DD	ZA Rechtecksteckverbinder 9-pol.	High Flex Leder	7S5FH083523615A12
ABITIG® 20F Little	4 m	DD	ZA Rechtecksteckverbinder 9-pol.	High Flex Leder	7L5FH043523615A12
	8 m	DD	ZA Rechtecksteckverbinder 9-pol.	High Flex Leder	7L5FH083523615A12

Technische Änderungen vorbehalten • Verkaufspreise = unverbindliche Preisempfehlung - Angebot freibleibend • © Copyright

ABITIG® GRIP / ABITIG® GRIP Little-Brennerpreisliste

passend für WIG-Stromquellen des Fabrikates „fronius“

Brennertyp	Länge	Schalterfunktion	maschinenseitiger Anschluss	Schlauchpaketausführung	Bestellnummer
ABITIG® 12-1	4 m	DD	ZA Rechtecksteckverbinder 9-pol.	Standard	7S6SK043523615A12
	8 m	DD	ZA Rechtecksteckverbinder 9-pol.	Standard	7S6SK083523615A12
	4 m	DD	ZA Rechtecksteckverbinder 9-pol.	High Flex Leder	7S6SH043523615A12
	8 m	DD	ZA Rechtecksteckverbinder 9-pol.	High Flex Leder	7S6SH083523615A12
ABITIG® 18SC	4 m	DD	ZA Rechtecksteckverbinder 9-pol.	Standard	7S7SK043523615A12
	8 m	DD	ZA Rechtecksteckverbinder 9-pol.	Standard	7S7SK083523615A12
	4 m	DD	ZA Rechtecksteckverbinder 9-pol.	High Flex Leder	7S7SH043523615A12
	8 m	DD	ZA Rechtecksteckverbinder 9-pol.	High Flex Leder	7S7SH083523615A12
ABITIG® 24W	4 m	DD	ZA Rechtecksteckverbinder 9-pol.	Standard	7S9SK043523615A12
	8 m	DD	ZA Rechtecksteckverbinder 9-pol.	Standard	7S9SK083523615A12
	4 m	DD	ZA Rechtecksteckverbinder 9-pol.	High Flex Leder	7S9SH043523615A12
	8 m	DD	ZA Rechtecksteckverbinder 9-pol.	High Flex Leder	7S9SH083523615A12
ABITIG® 24W Little	4 m	DD	ZA Rechtecksteckverbinder 9-pol.	High Flex Leder	7L9SH043523615A12
	8 m	DD	ZA Rechtecksteckverbinder 9-pol.	High Flex Leder	7L9SH083523615A12
ABITIG® 450W	4 m	DD	ZA Rechtecksteckverbinder 9-pol.	Standard	7T5SK043523615A12
	8 m	DD	ZA Rechtecksteckverbinder 9-pol.	Standard	7T5SK083523615A12
	4 m	DD	ZA Rechtecksteckverbinder 9-pol.	High Flex Leder	7T5SH043523615A12
	8 m	DD	ZA Rechtecksteckverbinder 9-pol.	High Flex Leder	7T5SH083523615A12
ABITIG® 260W	4 m	DD	ZA Rechtecksteckverbinder 9-pol.	Standard	7T7SK043523615A12
	8 m	DD	ZA Rechtecksteckverbinder 9-pol.	Standard	7T7SK083523615A12
	4 m	DD	ZA Rechtecksteckverbinder 9-pol.	High Flex Leder	7T7SH043523615A12
	8 m	DD	ZA Rechtecksteckverbinder 9-pol.	High Flex Leder	7T7SH083523615A12
ABITIG® 260W Little	4 m	DD	ZA Rechtecksteckverbinder 9-pol.	High Flex Leder	7L7SH043523615A12
	8 m	DD	ZA Rechtecksteckverbinder 9-pol.	High Flex Leder	7L7SH083523615A12
ABITIG® 450W SC	4 m	DD	ZA Rechtecksteckverbinder 9-pol.	Standard	
	8 m	DD	ZA Rechtecksteckverbinder 9-pol.	Standard	
	4 m	DD	ZA Rechtecksteckverbinder 9-pol.	High Flex Leder	7T8SH043523615A12
	8 m	DD	ZA Rechtecksteckverbinder 9-pol.	High Flex Leder	7T8SH083523615A12

ABITIG® GRIP / ABITIG® GRIP Little-Brennerpreisliste

passend für WIG-Stromquellen des Fabrikates „fronius“ Up/Down



Brennertyp	Länge	Schalterfunktion	maschinenseitiger Anschluss	Schlauchpaketausführung	Bestellnummer
ABITIG® 18	4 m	UD	ZA Rechtecksteckverbinder 9-pol.	Standard	7S4SK046653616A12
	8 m	UD	ZA Rechtecksteckverbinder 9-pol.	Standard	7S4SK086653616A12
	4 m	UD	ZA Rechtecksteckverbinder 9-pol.	High Flex Leder	7S4SH046653616A12
	8 m	UD	ZA Rechtecksteckverbinder 9-pol.	High Flex Leder	7S4SH086653616A12
ABITIG® 18F	4 m	UD	ZA Rechtecksteckverbinder 9-pol.	Standard	7S4FK046653616A12
	8 m	UD	ZA Rechtecksteckverbinder 9-pol.	Standard	7S4FK086653616A12
	4 m	UD	ZA Rechtecksteckverbinder 9-pol.	High Flex Leder	7S4FH046653616A12
	8 m	UD	ZA Rechtecksteckverbinder 9-pol.	High Flex Leder	7S4FH086653616A12
ABITIG® 20	4 m	UD	ZA Rechtecksteckverbinder 9-pol.	Standard	7S5SK046653616A12
	8 m	UD	ZA Rechtecksteckverbinder 9-pol.	Standard	7S5SK086653616A12
	4 m	UD	ZA Rechtecksteckverbinder 9-pol.	High Flex Leder	7S5SH046653616A12
	8 m	UD	ZA Rechtecksteckverbinder 9-pol.	High Flex Leder	7S5SH086653616A12
ABITIG® 20 Little	4 m	UD	ZA Rechtecksteckverbinder 9-pol.	High Flex Leder	7L5SH046653616A12
	8 m	UD	ZA Rechtecksteckverbinder 9-pol.	High Flex Leder	7L5SH086653616A12
ABITIG® 20F	4 m	UD	ZA Rechtecksteckverbinder 9-pol.	Standard	7S5FK046653616A12
	8 m	UD	ZA Rechtecksteckverbinder 9-pol.	Standard	7S5FK086653616A12
	4 m	UD	ZA Rechtecksteckverbinder 9-pol.	High Flex Leder	7S5FH046653616A12
	8 m	UD	ZA Rechtecksteckverbinder 9-pol.	High Flex Leder	7S5FH086653616A12
ABITIG® 20F Little	4 m	UD	ZA Rechtecksteckverbinder 9-pol.	High Flex Leder	7L5FH046653616A12
	8 m	UD	ZA Rechtecksteckverbinder 9-pol.	High Flex Leder	7L5FH086653616A12

Technische Änderungen vorbehalten • Verkaufspreise = unverbindliche Preisempfehlung - Angebot freibleibend • © Copyright

ABITIG® GRIP / ABITIG® GRIP Little-Brennerpreisliste

passend für WIG-Stromquellen des Fabrikates „fronius“ Up/Down

Brennertyp	Länge	Schalterfunktion	maschinenseitiger Anschluss	Schlauchpaketausführung	Bestellnummer
ABITIG® 12-1	4 m	UD	ZA Rechtecksteckverbinder 9-pol.	Standard	7S6SK046653616A12
	8 m	UD	ZA Rechtecksteckverbinder 9-pol.	Standard	7S6SK086653616A12
	4 m	UD	ZA Rechtecksteckverbinder 9-pol.	High Flex Leder	7S6SH046653616A12
	8 m	UD	ZA Rechtecksteckverbinder 9-pol.	High Flex Leder	7S6SH086653616A12
ABITIG® 18SC	4 m	UD	ZA Rechtecksteckverbinder 9-pol.	Standard	7S7SK046653616A12
	8 m	UD	ZA Rechtecksteckverbinder 9-pol.	Standard	7S7SK086653616A12
	4 m	UD	ZA Rechtecksteckverbinder 9-pol.	High Flex Leder	7S7SH046653616A12
	8 m	UD	ZA Rechtecksteckverbinder 9-pol.	High Flex Leder	7S7SH086653616A12
ABITIG® 24W	4 m	UD	ZA Rechtecksteckverbinder 9-pol.	Standard	7S9SK046653616A12
	8 m	UD	ZA Rechtecksteckverbinder 9-pol.	Standard	7S9SK086653616A12
	4 m	UD	ZA Rechtecksteckverbinder 9-pol.	High Flex Leder	7S9SH046653616A12
	8 m	UD	ZA Rechtecksteckverbinder 9-pol.	High Flex Leder	7S9SH086653616A12
ABITIG® 24W Little	4 m	UD	ZA Rechtecksteckverbinder 9-pol.	High Flex Leder	7L9SH046653616A12
	8 m	UD	ZA Rechtecksteckverbinder 9-pol.	High Flex Leder	7L9SH086653616A12
ABITIG® 450W	4 m	UD	ZA Rechtecksteckverbinder 9-pol.	Standard	7T5SK046653616A12
	8 m	UD	ZA Rechtecksteckverbinder 9-pol.	Standard	7T5SK086653616A12
	4 m	UD	ZA Rechtecksteckverbinder 9-pol.	High Flex Leder	7T5SH046653616A12
	8 m	UD	ZA Rechtecksteckverbinder 9-pol.	High Flex Leder	7T5SH086653616A12
	4 m	UD	ZA Rechtecksteckverbinder 9-pol.	PVC-Leder	
	8 m	UD	ZA Rechtecksteckverbinder 9-pol.	PVC-Leder	
ABITIG® 260W	4 m	UD	ZA Rechtecksteckverbinder 9-pol.	Standard	7T7SK046653616A12
	8 m	UD	ZA Rechtecksteckverbinder 9-pol.	Standard	7T7SK086653616A12
	4 m	UD	ZA Rechtecksteckverbinder 9-pol.	High Flex Leder	7T7SH046653616A12
	8 m	UD	ZA Rechtecksteckverbinder 9-pol.	High Flex Leder	7T7SH086653616A12
ABITIG® 260W Little	4 m	UD	ZA Rechtecksteckverbinder 9-pol.	High Flex Leder	7L7SH046653616A12
	8 m	UD	ZA Rechtecksteckverbinder 9-pol.	High Flex Leder	7L7SH086653616A12
ABITIG® 450W SC	4 m	UD	ZA Rechtecksteckverbinder 9-pol.	Standard	
	8 m	UD	ZA Rechtecksteckverbinder 9-pol.	Standard	
	4 m	UD	ZA Rechtecksteckverbinder 9-pol.	High Flex Leder	7T8SH046653616A12
	8 m	UD	ZA Rechtecksteckverbinder 9-pol.	High Flex Leder	7T8SH086653616A12

ABITIG® GRIP / ABITIG® GRIP Little-Brennerpreisliste

passend für WIG-Stromquellen des Fabrikates „fronius“



Brennertyp	Länge	Schalterfunktion	maschinenseitiger Anschluss	Schlauchpaketausführung	Bestellnummer
ABITIG® 18	4 m	UD	ZA - WZ-0 Tuchel 5-pol.	Standard	7S4SK043650363B12
	8 m	UD	ZA - WZ-0 Tuchel 5-pol.	Standard	7S4SK083650363B12
	4 m	UD	ZA - WZ-0 Tuchel 5-pol.	High Flex Leder	7S4SH043650363B12
	8 m	UD	ZA - WZ-0 Tuchel 5-pol.	High Flex Leder	7S4SH083650363B12
ABITIG® 18F	4 m	UD	ZA - WZ-0 Tuchel 5-pol.	Standard	7S4FK043650363B12
	8 m	UD	ZA - WZ-0 Tuchel 5-pol.	Standard	7S4FK083650363B12
	4 m	UD	ZA - WZ-0 Tuchel 5-pol.	High Flex Leder	7S4FH043650363B12
	8 m	UD	ZA - WZ-0 Tuchel 5-pol.	High Flex Leder	7S4FH083650363B12
ABITIG® 20	4 m	UD	ZA - WZ-0 Tuchel 5-pol.	Standard	7S5SK043650363B12
	8 m	UD	ZA - WZ-0 Tuchel 5-pol.	Standard	7S5SK083650363B12
	4 m	UD	ZA - WZ-0 Tuchel 5-pol.	High Flex Leder	7S5SH043650363B12
	8 m	UD	ZA - WZ-0 Tuchel 5-pol.	High Flex Leder	7S5SH083650363B12
ABITIG® 20 Little	4 m	UD	ZA - WZ-0 Tuchel 5-pol.	High Flex Leder	7L5SH043650363B12
	8 m	UD	ZA - WZ-0 Tuchel 5-pol.	High Flex Leder	7L5SH083650363B12
ABITIG® 20F	4 m	UD	ZA - WZ-0 Tuchel 5-pol.	Standard	7S5FK043650363B12
	8 m	UD	ZA - WZ-0 Tuchel 5-pol.	Standard	7S5FK083650363B12
	4 m	UD	ZA - WZ-0 Tuchel 5-pol.	High Flex Leder	7S5FH043650363B12
	8 m	UD	ZA - WZ-0 Tuchel 5-pol.	High Flex Leder	7S5FH083650363B12
ABITIG® 20F Little	4 m	UD	ZA - WZ-0 Tuchel 5-pol.	High Flex Leder	7L5FH043650363B12
	8 m	UD	ZA - WZ-0 Tuchel 5-pol.	High Flex Leder	7L5FH083650363B12

Technische Änderungen vorbehalten • Verkaufspreise = unverbindliche Preisempfehlung - Angebot freibleibend • © Copyright

ABITIG® GRIP / ABITIG® GRIP Little-Brennerpreisliste

passend für WIG-Stromquellen des Fabrikates „fronius“

Brennertyp	Länge	Schalterfunktion	maschinenseitiger Anschluss	Schlauchpaketausführung	Bestellnummer
ABITIG® 12-1	4 m	UD	ZA - WZ-0 Tuchel 5-pol.	Standard	7S6SK043650363B12
	8 m	UD	ZA - WZ-0 Tuchel 5-pol.	Standard	7S6SK083650363B12
	4 m	UD	ZA - WZ-0 Tuchel 5-pol.	High Flex Leder	7S6SH043650363B12
	8 m	UD	ZA - WZ-0 Tuchel 5-pol.	High Flex Leder	7S6SH083650363B12
ABITIG® 18SC	4 m	UD	ZA - WZ-0 Tuchel 5-pol.	Standard	7S7SK043650363B12
	8 m	UD	ZA - WZ-0 Tuchel 5-pol.	Standard	7S7SK083650363B12
	4 m	UD	ZA - WZ-0 Tuchel 5-pol.	High Flex Leder	7S7SH043650363B12
	8 m	UD	ZA - WZ-0 Tuchel 5-pol.	High Flex Leder	7S7SH083650363B12
ABITIG® 24W	4 m	UD	ZA - WZ-0 Tuchel 5-pol.	Standard	7S9SK043650363B12
	8 m	UD	ZA - WZ-0 Tuchel 5-pol.	Standard	7S9SK083650363B12
	4 m	UD	ZA - WZ-0 Tuchel 5-pol.	High Flex Leder	7S9SH043650363B12
	8 m	UD	ZA - WZ-0 Tuchel 5-pol.	High Flex Leder	7S9SH083650363B12
ABITIG® 24W Little	4 m	UD	ZA - WZ-0 Tuchel 5-pol.	High Flex Leder	7L9SH043650363B12
	8 m	UD	ZA - WZ-0 Tuchel 5-pol.	High Flex Leder	7L9SH083650363B12
ABITIG® 450W	4 m	UD	ZA - WZ-0 Tuchel 5-pol.	Standard	7T5SK043650363B12
	8 m	UD	ZA - WZ-0 Tuchel 5-pol.	Standard	7T5SK083650363B12
	4 m	UD	ZA - WZ-0 Tuchel 5-pol.	High Flex Leder	7T5SH043650363B12
	8 m	UD	ZA - WZ-0 Tuchel 5-pol.	High Flex Leder	7T5SH083650363B12
ABITIG® 260W	4 m	UD	ZA - WZ-0 Tuchel 5-pol.	Standard	7T7SK043650363B12
	8 m	UD	ZA - WZ-0 Tuchel 5-pol.	Standard	7T7SK083650363B12
	4 m	UD	ZA - WZ-0 Tuchel 5-pol.	High Flex Leder	7T7SH043650363B12
	8 m	UD	ZA - WZ-0 Tuchel 5-pol.	High Flex Leder	7T7SH083650363B12
ABITIG® 260W Little	4 m	UD	ZA - WZ-0 Tuchel 5-pol.	High Flex Leder	7L7SH043650363B12
	8 m	UD	ZA - WZ-0 Tuchel 5-pol.	High Flex Leder	7L7SH083650363B12
ABITIG® 450W SC	4 m	UD	ZA - WZ-0 Tuchel 5-pol.	Standard	
	8 m	UD	ZA - WZ-0 Tuchel 5-pol.	Standard	
	4 m	UD	ZA - WZ-0 Tuchel 5-pol.	High Flex Leder	7T8SH043650363B12
	8 m	UD	ZA - WZ-0 Tuchel 5-pol.	High Flex Leder	7T8SH083650363B12

ABITIG® GRIP / ABITIG® GRIP Little-Brennerpreisliste

passend für WIG-Stromquellen des Fabrikates „hermann“

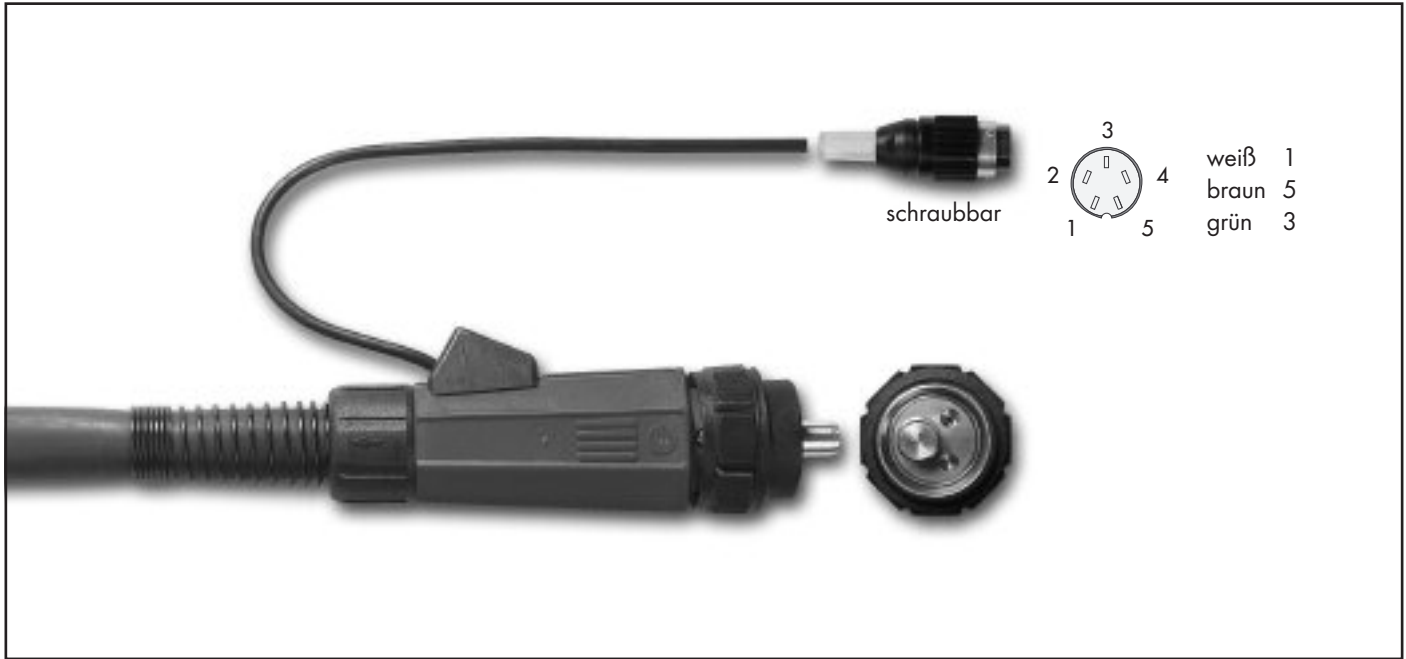

Brennertyp	Länge	Schalterfunktion	maschinenseitiger Anschluss	Schlauchpaketausführung	Bestellnummer
ABITIG® 9	4 m	DD	ZA - GZ Tuchel 5-pol. schraub.	Standard	7S1SK043520345A00
	8 m	DD	ZA - GZ Tuchel 5-pol. schraub.	Standard	7S1SK083520345A00
	4 m	DD	ZA - GZ Tuchel 5-pol. schraub.	High Flex Leder	7S1SH043520345A00
	8 m	DD	ZA - GZ Tuchel 5-pol. schraub.	High Flex Leder	7S1SH083520345A00
ABITIG® 9 Little	4 m	DD	ZA - GZ Tuchel 5-pol. schraub.	High Flex Leder	7L1SH043520345A00
	8 m	DD	ZA - GZ Tuchel 5-pol. schraub.	High Flex Leder	7L1SH083520345A00
ABITIG® 9F	4 m	DD	ZA - GZ Tuchel 5-pol. schraub.	Standard	7S1FK043520345A00
	8 m	DD	ZA - GZ Tuchel 5-pol. schraub.	Standard	7S1FK083520345A00
	4 m	DD	ZA - GZ Tuchel 5-pol. schraub.	High Flex Leder	7S1FH043520345A00
	8 m	DD	ZA - GZ Tuchel 5-pol. schraub.	High Flex Leder	7S1FH083520345A00
ABITIG® 9F Little	4 m	DD	ZA - GZ Tuchel 5-pol. schraub.	High Flex Leder	7L1FH043520345A00
	8 m	DD	ZA - GZ Tuchel 5-pol. schraub.	High Flex Leder	7L1FH083520345A00
ABITIG® 17	4 m	DD	ZA - GZ Tuchel 5-pol. schraub.	Standard	7S2SK043520345A00
	8 m	DD	ZA - GZ Tuchel 5-pol. schraub.	Standard	7S2SK083520345A00
	4 m	DD	ZA - GZ Tuchel 5-pol. schraub.	High Flex Leder	7S2SH043520345A00
	8 m	DD	ZA - GZ Tuchel 5-pol. schraub.	High Flex Leder	7S2SH083520345A00
ABITIG® 17 Little	4 m	DD	ZA - GZ Tuchel 5-pol. schraub.	High Flex Leder	7L2SH043520345A00
	8 m	DD	ZA - GZ Tuchel 5-pol. schraub.	High Flex Leder	7L2SH083520345A00
ABITIG® 17F	4 m	DD	ZA - GZ Tuchel 5-pol. schraub.	Standard	7S2FK043520345A00
	8 m	DD	ZA - GZ Tuchel 5-pol. schraub.	Standard	7S2FK083520345A00
	4 m	DD	ZA - GZ Tuchel 5-pol. schraub.	High Flex Leder	7S2FH043520345A00
	8 m	DD	ZA - GZ Tuchel 5-pol. schraub.	High Flex Leder	7S2FH083520345A00
ABITIG® 17F Little	4 m	DD	ZA - GZ Tuchel 5-pol. schraub.	High Flex Leder	7L2FH043520345A00
	8 m	DD	ZA - GZ Tuchel 5-pol. schraub.	High Flex Leder	7L2FH083520345A00

Technische Änderungen vorbehalten • Verkaufspreise = unverbindliche Preisempfehlung - Angebot freibleibend • © Copyright

ABITIG® GRIP / ABITIG® GRIP Little-Brennerpreisliste

passend für WIG-Stromquellen des Fabrikates „hermann“

Brennertyp	Länge	Schalterfunktion	maschinenseitiger Anschluss	Schlauchpaketausführung	Bestellnummer
ABITIG® 26	4 m	DD	ZA - GZ Tuchel 5-pol. schraub.	Standard	7S3SK043520345A00
	8 m	DD	ZA - GZ Tuchel 5-pol. schraub.	Standard	7S3SK083520345A00
	4 m	DD	ZA - GZ Tuchel 5-pol. schraub.	High Flex Leder	7S3SH043520345A00
	8 m	DD	ZA - GZ Tuchel 5-pol. schraub.	High Flex Leder	7S3SH083520345A00
ABITIG® 26F	4 m	DD	ZA - GZ Tuchel 5-pol. schraub.	Standard	7S3FK043520345A00
	8 m	DD	ZA - GZ Tuchel 5-pol. schraub.	Standard	7S3FK083520345A00
	4 m	DD	ZA - GZ Tuchel 5-pol. schraub.	High Flex Leder	7S3FH043520345A00
	8 m	DD	ZA - GZ Tuchel 5-pol. schraub.	High Flex Leder	7S3FH083520345A00
ABITIG® 24G	4 m	DD	ZA - GZ Tuchel 5-pol. schraub.	Standard	7S8SK043520345A00
	8 m	DD	ZA - GZ Tuchel 5-pol. schraub.	Standard	7S8SK083520345A00
	4 m	DD	ZA - GZ Tuchel 5-pol. schraub.	High Flex Leder	7S8SH043520345A00
	8 m	DD	ZA - GZ Tuchel 5-pol. schraub.	High Flex Leder	7S8SH083520345A00
ABITIG® 24G Little	4 m	DD	ZA - GZ Tuchel 5-pol. schraub.	High Flex Leder	7L8SH043520345A00
	8 m	DD	ZA - GZ Tuchel 5-pol. schraub.	High Flex Leder	7L8SH083520345A00
ABITIG® 200	4 m	DD	ZA - GZ Tuchel 5-pol. schraub.	Standard	7T4SK043520345A00
	8 m	DD	ZA - GZ Tuchel 5-pol. schraub.	Standard	7T4SK083520345A00
	4 m	DD	ZA - GZ Tuchel 5-pol. schraub.	High Flex Leder	7T4SH043520345A00
	8 m	DD	ZA - GZ Tuchel 5-pol. schraub.	High Flex Leder	7T4SH083520345A00
ABITIG® 200F	4 m	DD	ZA - GZ Tuchel 5-pol. schraub.	Standard	7T4FK043520345A00
	8 m	DD	ZA - GZ Tuchel 5-pol. schraub.	Standard	7T4FK083520345A00
	4 m	DD	ZA - GZ Tuchel 5-pol. schraub.	High Flex Leder	7T4FH043520345A00
	8 m	DD	ZA - GZ Tuchel 5-pol. schraub.	High Flex Leder	7T4FH083520345A00
ABITIG® 150	4 m	DD	ZA - GZ Tuchel 5-pol. schraub.	Standard	7T6SK043520345A00
	8 m	DD	ZA - GZ Tuchel 5-pol. schraub.	Standard	7T6SK083520345A00
	4 m	DD	ZA - GZ Tuchel 5-pol. schraub.	High Flex Leder	7T6SH043520345A00
	8 m	DD	ZA - GZ Tuchel 5-pol. schraub.	High Flex Leder	7T6SH083520345A00
ABITIG® 150 Little	4 m	DD	ZA - GZ Tuchel 5-pol. schraub.	High Flex Leder	7L6SH043520345A00
	8 m	DD	ZA - GZ Tuchel 5-pol. schraub.	High Flex Leder	7L6SH083520345A00
ABITIG® 150F	4 m	DD	ZA - GZ Tuchel 5-pol. schraub.	Standard	7T6FK043520345A00
	8 m	DD	ZA - GZ Tuchel 5-pol. schraub.	Standard	7T6FK083520345A00
	4 m	DD	ZA - GZ Tuchel 5-pol. schraub.	High Flex Leder	7T6FH043520345A00
	8 m	DD	ZA - GZ Tuchel 5-pol. schraub.	High Flex Leder	7T6FH083520345A00
ABITIG® 150F Little	4 m	DD	ZA - GZ Tuchel 5-pol. schraub.	High Flex Leder	7L6FH043520345A00
	8 m	DD	ZA - GZ Tuchel 5-pol. schraub.	High Flex Leder	7L6FH083520345A00

ABITIG® GRIP / ABITIG® GRIP Little-Brennerpreisliste

passend für WIG-Stromquellen des Fabrikates „hermann“

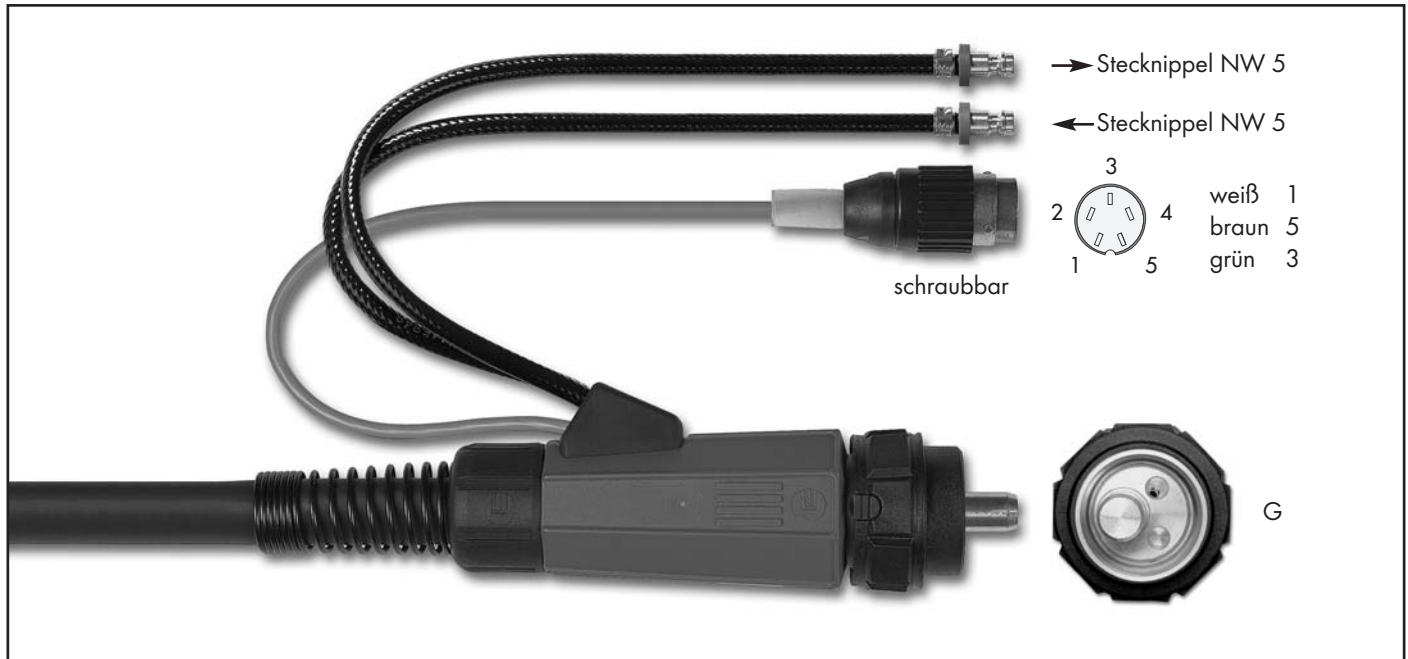

Brennertyp	Länge	Schalterfunktion	maschinenseitiger Anschluss	Schlauchpaketausführung	Bestellnummer
ABITIG® 18	4 m	DD	ZA - WZ-0 Tuchel 5-pol. schraub.	Standard	7S4SK043520345A12
	8 m	DD	ZA - WZ-0 Tuchel 5-pol. schraub.	Standard	7S4SK083520345A12
	4 m	DD	ZA - WZ-0 Tuchel 5-pol. schraub.	High Flex Leder	7S4SH043520345A12
	8 m	DD	ZA - WZ-0 Tuchel 5-pol. schraub.	High Flex Leder	7S4SH083520345A12
ABITIG® 18F	4 m	DD	ZA - WZ-0 Tuchel 5-pol. schraub.	Standard	7S4FK043520345A12
	8 m	DD	ZA - WZ-0 Tuchel 5-pol. schraub.	Standard	7S4FK083520345A12
	4 m	DD	ZA - WZ-0 Tuchel 5-pol. schraub.	High Flex Leder	7S4FH043520345A12
	8 m	DD	ZA - WZ-0 Tuchel 5-pol. schraub.	High Flex Leder	7S4FH083520345A12
ABITIG® 20	4 m	DD	ZA - WZ-0 Tuchel 5-pol. schraub.	Standard	7S5SK043520345A12
	8 m	DD	ZA - WZ-0 Tuchel 5-pol. schraub.	Standard	7S5SK083520345A12
	4 m	DD	ZA - WZ-0 Tuchel 5-pol. schraub.	High Flex Leder	7S5SH043520345A12
	8 m	DD	ZA - WZ-0 Tuchel 5-pol. schraub.	High Flex Leder	7S5SH083520345A12
ABITIG® 20 Little	4 m	DD	ZA - WZ-0 Tuchel 5-pol. schraub.	High Flex Leder	7L5SH043520345A12
	8 m	DD	ZA - WZ-0 Tuchel 5-pol. schraub.	High Flex Leder	7L5SH083520345A12
ABITIG® 20F	4 m	DD	ZA - WZ-0 Tuchel 5-pol. schraub.	Standard	7S5FK043520345A12
	8 m	DD	ZA - WZ-0 Tuchel 5-pol. schraub.	Standard	7S5FK083520345A12
	4 m	DD	ZA - WZ-0 Tuchel 5-pol. schraub.	High Flex Leder	7S5FH043520345A12
	8 m	DD	ZA - WZ-0 Tuchel 5-pol. schraub.	High Flex Leder	7S5FH083520345A12
ABITIG® 20F Little	4 m	DD	ZA - WZ-0 Tuchel 5-pol. schraub.	High Flex Leder	7L5FH043520345A12
	8 m	DD	ZA - WZ-0 Tuchel 5-pol. schraub.	High Flex Leder	7L5FH083520345A12

Technische Änderungen vorbehalten • Verkaufspreise = unverbindliche Preisempfehlung - Angebot freibleibend • © Copyright

ABITIG® GRIP / ABITIG® GRIP Little-Brennerpreisliste

passend für WIG-Stromquellen des Fabrikates „hermann“

Brennertyp	Länge	Schalterfunktion	maschinenseitiger Anschluss	Schlauchpaketausführung	Bestellnummer
ABITIG® 12-1	4 m	DD	ZA - WZ-0 Tuchel 5-pol. schraub.	Standard	7S6SK043520345A12
	8 m	DD	ZA - WZ-0 Tuchel 5-pol. schraub.	Standard	7S6SK083520345A12
	4 m	DD	ZA - WZ-0 Tuchel 5-pol. schraub.	High Flex Leder	7S6SH043520345A12
	8 m	DD	ZA - WZ-0 Tuchel 5-pol. schraub.	High Flex Leder	7S6SH083520345A12
ABITIG® 18 SC	4 m	DD	ZA - WZ-0 Tuchel 5-pol. schraub.	Standard	7S7SK043520345A12
	8 m	DD	ZA - WZ-0 Tuchel 5-pol. schraub.	Standard	7S7SK083520345A12
	4 m	DD	ZA - WZ-0 Tuchel 5-pol. schraub.	High Flex Leder	7S7SH043520345A12
	8 m	DD	ZA - WZ-0 Tuchel 5-pol. schraub.	High Flex Leder	7S7SH083520345A12
ABITIG® 24W	4 m	DD	ZA - WZ-0 Tuchel 5-pol. schraub.	Standard	7S9SK043520345A12
	8 m	DD	ZA - WZ-0 Tuchel 5-pol. schraub.	Standard	7S9SK083520345A12
	4 m	DD	ZA - WZ-0 Tuchel 5-pol. schraub.	High Flex Leder	7S9SH043520345A12
	8 m	DD	ZA - WZ-0 Tuchel 5-pol. schraub.	High Flex Leder	7S9SH083520345A12
ABITIG® 24W Little	4 m	DD	ZA - WZ-0 Tuchel 5-pol. schraub.	High Flex Leder	7L9SH043520345A12
	8 m	DD	ZA - WZ-0 Tuchel 5-pol. schraub.	High Flex Leder	7L9SH083520345A12
ABITIG® 450W	4 m	DD	ZA - WZ-0 Tuchel 5-pol. schraub.	Standard	7T5SK043520345A12
	8 m	DD	ZA - WZ-0 Tuchel 5-pol. schraub.	Standard	7T5SK083520345A12
	4 m	DD	ZA - WZ-0 Tuchel 5-pol. schraub.	High Flex Leder	7T5SH043520345A12
	8 m	DD	ZA - WZ-0 Tuchel 5-pol. schraub.	High Flex Leder	7T5SH083520345A12
ABITIG® 260W	4 m	DD	ZA - WZ-0 Tuchel 5-pol. schraub.	Standard	7T7SK043520345A12
	8 m	DD	ZA - WZ-0 Tuchel 5-pol. schraub.	Standard	7T7SK083520345A12
	4 m	DD	ZA - WZ-0 Tuchel 5-pol. schraub.	High Flex Leder	7T7SH043520345A12
	8 m	DD	ZA - WZ-0 Tuchel 5-pol. schraub.	High Flex Leder	7T7SH083520345A12
ABITIG® 450W SC	4 m	DD	ZA - WZ-0 Tuchel 5-pol. schraub.	Standard	
	8 m	DD	ZA - WZ-0 Tuchel 5-pol. schraub.	Standard	
	4 m	DD	ZA - WZ-0 Tuchel 5-pol. schraub.	High Flex Leder	7T8SH043520345A12
	8 m	DD	ZA - WZ-0 Tuchel 5-pol. schraub.	High Flex Leder	7T8SH083520345A12

ABITIG® GRIP / ABITIG® GRIP Little-Brennerpreisliste

passend für WIG-Stromquellen des Fabrikates „jäckle“

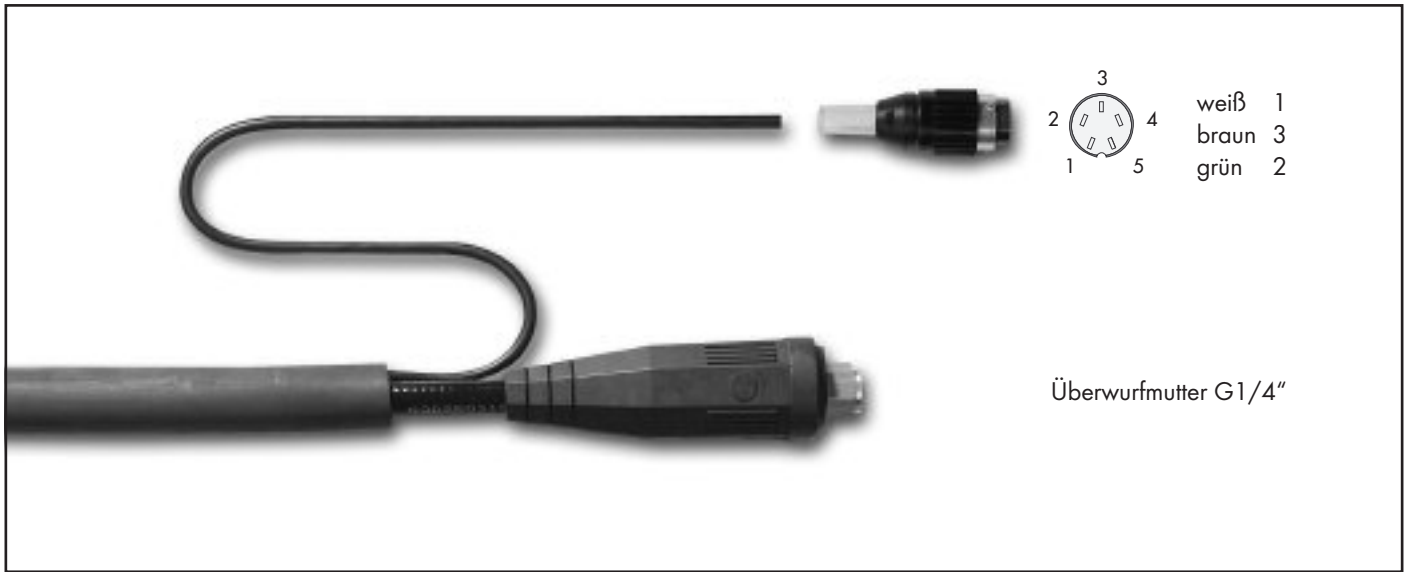

Brennertyp	Länge	Schalterfunktion	maschinenseitiger Anschluss	Schlauchpaketausführung	Bestellnummer
ABITIG® 9	4 m	DD	EA Tuchel 5-pol.	Standard	7S1SK043521101B00
	8 m	DD	EA Tuchel 5-pol.	Standard	7S1SK083521101B00
	4 m	DD	EA Tuchel 5-pol.	High Flex Leder	7S1SH043521101B00
	8 m	DD	EA Tuchel 5-pol.	High Flex Leder	7S1SH083521101B00
ABITIG® 9 Little	4 m	DD	EA Tuchel 5-pol.	High Flex Leder	7L1SH043521101B00
	8 m	DD	EA Tuchel 5-pol.	High Flex Leder	7L1SH083521101B00
ABITIG® 9F	4 m	DD	EA Tuchel 5-pol.	Standard	7S1FK043521101B00
	8 m	DD	EA Tuchel 5-pol.	Standard	7S1FK083521101B00
	4 m	DD	EA Tuchel 5-pol.	High Flex Leder	7S1FH043521101B00
	8 m	DD	EA Tuchel 5-pol.	High Flex Leder	7S1FH083521101B00
ABITIG® 9F Little	4 m	DD	EA Tuchel 5-pol.	High Flex Leder	7L1FH043521101B00
	8 m	DD	EA Tuchel 5-pol.	High Flex Leder	7L1FH083521101B00
ABITIG® 17	4 m	DD	EA Tuchel 5-pol.	Standard	7S2SK043521101B00
	8 m	DD	EA Tuchel 5-pol.	Standard	7S2SK083521101B00
	4 m	DD	EA Tuchel 5-pol.	High Flex Leder	7S2SH043521101B00
	8 m	DD	EA Tuchel 5-pol.	High Flex Leder	7S2SH083521101B00
ABITIG® 17 Little	4 m	DD	EA Tuchel 5-pol.	High Flex Leder	7L2SH043521101B00
	8 m	DD	EA Tuchel 5-pol.	High Flex Leder	7L2SH083521101B00
ABITIG® 17F	4 m	DD	EA Tuchel 5-pol.	Standard	7S2FK043521101B00
	8 m	DD	EA Tuchel 5-pol.	Standard	7S2FK083521101B00
	4 m	DD	EA Tuchel 5-pol.	High Flex Leder	7S2FH043521101B00
	8 m	DD	EA Tuchel 5-pol.	High Flex Leder	7S2FH083521101B00
ABITIG® 17F Little	4 m	DD	EA Tuchel 5-pol.	High Flex Leder	7L2FH043521101B00
	8 m	DD	EA Tuchel 5-pol.	High Flex Leder	7L2FH083521101B00

Technische Änderungen vorbehalten • Verkaufspreise = unverbindliche Preisempfehlung - Angebot freibleibend • © Copyright

ABITIG® GRIP / ABITIG® GRIP Little-Brennerpreisliste

passend für WIG-Stromquellen des Fabrikates „jäckle“

Brennertyp	Länge	Schalterfunktion	maschinenseitiger Anschluss	Schlauchpaketausführung	Bestellnummer
ABITIG® 26	4 m	DD	EA Tuchel 5-pol.	Standard	7S3SK043521101B00
	8 m	DD	EA Tuchel 5-pol.	Standard	7S3SK083521101B00
	4 m	DD	EA Tuchel 5-pol.	High Flex Leder	7S3SH043521101B00
	8 m	DD	EA Tuchel 5-pol.	High Flex Leder	7S3SH083521101B00
ABITIG® 26F	4 m	DD	EA Tuchel 5-pol.	Standard	7S3FK043521101B00
	8 m	DD	EA Tuchel 5-pol.	Standard	7S3FK083521101B00
	4 m	DD	EA Tuchel 5-pol.	High Flex Leder	7S3FH043521101B00
	8 m	DD	EA Tuchel 5-pol.	High Flex Leder	7S3FH083521101B00
ABITIG® 24G	4 m	DD	EA Tuchel 5-pol.	Standard	7S8SK043521101B00
	8 m	DD	EA Tuchel 5-pol.	Standard	7S8SK083521101B00
	4 m	DD	EA Tuchel 5-pol.	High Flex Leder	7S8SH043521101B00
	8 m	DD	EA Tuchel 5-pol.	High Flex Leder	7S8SH083521101B00
ABITIG® 24G Little	4 m	DD	EA Tuchel 5-pol.	High Flex Leder	7L8SH043521101B00
	8 m	DD	EA Tuchel 5-pol.	High Flex Leder	7L8SH083521101B00
ABITIG® 200	4 m	DD	EA Tuchel 5-pol.	Standard	7T4SK043521101B00
	8 m	DD	EA Tuchel 5-pol.	Standard	7T4SK083521101B00
	4 m	DD	EA Tuchel 5-pol.	High Flex Leder	7T4SH043521101B00
	8 m	DD	EA Tuchel 5-pol.	High Flex Leder	7T4SH083521101B00
ABITIG® 200F	4 m	DD	EA Tuchel 5-pol.	Standard	7T4FK043521101B00
	8 m	DD	EA Tuchel 5-pol.	Standard	7T4FK083521101B00
	4 m	DD	EA Tuchel 5-pol.	High Flex Leder	7T4FH043521101B00
	8 m	DD	EA Tuchel 5-pol.	High Flex Leder	7T4FH083521101B00
ABITIG® 150	4 m	DD	EA Tuchel 5-pol.	Standard	7T6SK043521101B00
	8 m	DD	EA Tuchel 5-pol.	Standard	7T6SK083521101B00
	4 m	DD	EA Tuchel 5-pol.	High Flex Leder	7T6SH043521101B00
	8 m	DD	EA Tuchel 5-pol.	High Flex Leder	7T6SH083521101B00
ABITIG® 150 Little	4 m	DD	EA Tuchel 5-pol.	High Flex Leder	7L6SH043521101B00
	8 m	DD	EA Tuchel 5-pol.	High Flex Leder	7L6SH083521101B00
ABITIG® 150F	4 m	DD	EA Tuchel 5-pol.	Standard	7T6FK043521101B00
	8 m	DD	EA Tuchel 5-pol.	Standard	7T6FK083521101B00
	4 m	DD	EA Tuchel 5-pol.	High Flex Leder	7T6FH043521101B00
	8 m	DD	EA Tuchel 5-pol.	High Flex Leder	7T6FH083521101B00
ABITIG® 150F Little	4 m	DD	EA Tuchel 5-pol.	High Flex Leder	7L6FH043521101B00
	8 m	DD	EA Tuchel 5-pol.	High Flex Leder	7L6FH083521101B00

ABITIG® GRIP / ABITIG® GRIP Little-Brennerpreisliste

passend für WIG-Stromquellen des Fabrikates „jäckle“

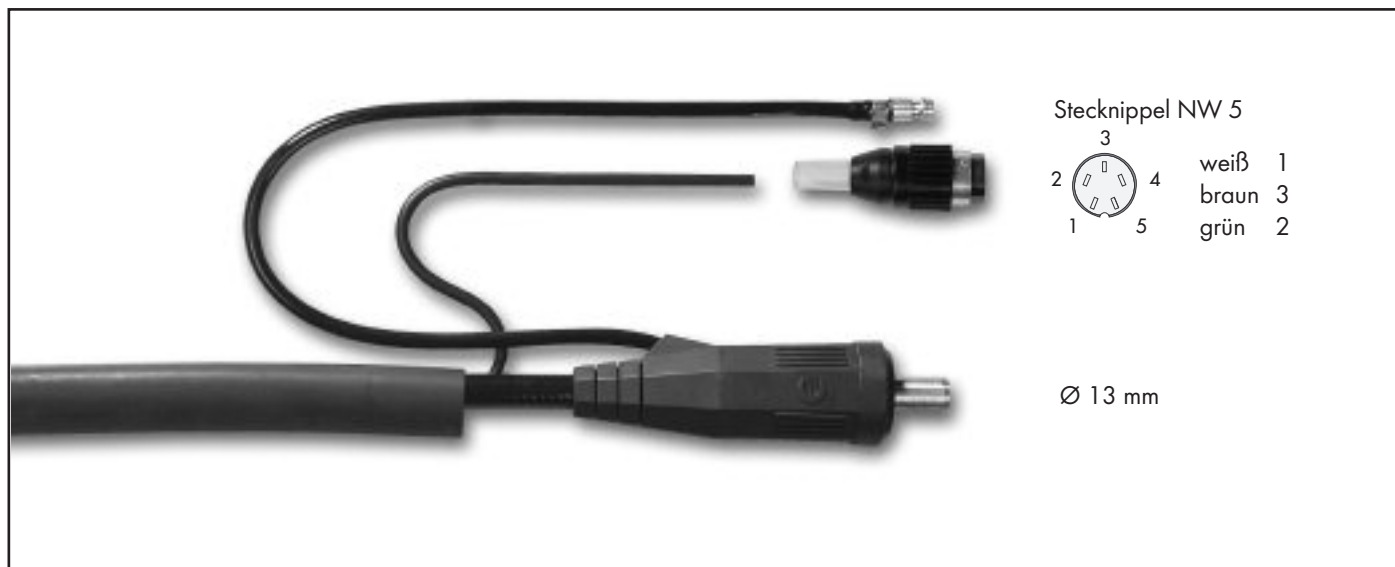

Brennertyp	Länge	Schalterfunktion	maschinenseitiger Anschluss	Schlauchpaketausführung	Bestellnummer
ABITIG® 9	4 m	DD	BSB 35-50 Tuchel 5-pol.	Standard	7S1SK043520001B06
	8 m	DD	BSB 35-50 Tuchel 5-pol.	Standard	7S1SK083520001B06
	4 m	DD	BSB 35-50 Tuchel 5-pol.	High Flex Leder	7S1SH043520001B06
	8 m	DD	BSB 35-50 Tuchel 5-pol.	High Flex Leder	7S1SH083520001B06
ABITIG® 9 Little	4 m	DD	BSB 35-50 Tuchel 5-pol.	High Flex Leder	7L1SH043520001B06
	8 m	DD	BSB 35-50 Tuchel 5-pol.	High Flex Leder	7L1SH083520001B06
ABITIG® 9F	4 m	DD	BSB 35-50 Tuchel 5-pol.	Standard	7S1FK043520001B06
	8 m	DD	BSB 35-50 Tuchel 5-pol.	Standard	7S1FK083520001B06
	4 m	DD	BSB 35-50 Tuchel 5-pol.	High Flex Leder	7S1FH043520001B06
	8 m	DD	BSB 35-50 Tuchel 5-pol.	High Flex Leder	7S1FH083520001B06
ABITIG® 9F Little	4 m	DD	BSB 35-50 Tuchel 5-pol.	High Flex Leder	7L1FH043520001B06
	8 m	DD	BSB 35-50 Tuchel 5-pol.	High Flex Leder	7L1FH083520001B06
ABITIG® 17	4 m	DD	BSB 35-50 Tuchel 5-pol.	Standard	7S2SK043520001B06
	8 m	DD	BSB 35-50 Tuchel 5-pol.	Standard	7S2SK083520001B06
	4 m	DD	BSB 35-50 Tuchel 5-pol.	High Flex Leder	7S2SH043520001B06
	8 m	DD	BSB 35-50 Tuchel 5-pol.	High Flex Leder	7S2SH083520001B06
ABITIG® 17 Little	4 m	DD	BSB 35-50 Tuchel 5-pol.	High Flex Leder	7L2SH043520001B06
	8 m	DD	BSB 35-50 Tuchel 5-pol.	High Flex Leder	7L2SH083520001B06
ABITIG® 17F	4 m	DD	BSB 35-50 Tuchel 5-pol.	Standard	7S2FK043520001B06
	8 m	DD	BSB 35-50 Tuchel 5-pol.	Standard	7S2FK083520001B06
	4 m	DD	BSB 35-50 Tuchel 5-pol.	High Flex Leder	7S2FH043520001B06
	8 m	DD	BSB 35-50 Tuchel 5-pol.	High Flex Leder	7S2FH083520001B06
ABITIG® 17F Little	4 m	DD	BSB 35-50 Tuchel 5-pol.	High Flex Leder	7L2FH043520001B06
	8 m	DD	BSB 35-50 Tuchel 5-pol.	High Flex Leder	7L2FH083520001B06

Technische Änderungen vorbehalten • Verkaufspreise = unverbindliche Preisempfehlung - Angebot freibleibend • © Copyright

ABITIG® GRIP / ABITIG® GRIP Little-Brennerpreisliste

passend für WIG-Stromquellen des Fabrikates „jäckle“

Brennertyp	Länge	Schalterfunktion	maschinenseitiger Anschluss	Schlauchpaketausführung	Bestellnummer
ABITIG® 26	4 m	DD	BSB 35-50 Tuchel 5-pol.	Standard	7S3SK043520001B06
	8 m	DD	BSB 35-50 Tuchel 5-pol.	Standard	7S3SK083520001B06
	4 m	DD	BSB 35-50 Tuchel 5-pol.	High Flex Leder	7S3SH043520001B06
	8 m	DD	BSB 35-50 Tuchel 5-pol.	High Flex Leder	7S3SH083520001B06
ABITIG® 26F	4 m	DD	BSB 35-50 Tuchel 5-pol.	Standard	7S3FK043520001B06
	8 m	DD	BSB 35-50 Tuchel 5-pol.	Standard	7S3FK083520001B06
	4 m	DD	BSB 35-50 Tuchel 5-pol.	High Flex Leder	7S3FH043520001B06
	8 m	DD	BSB 35-50 Tuchel 5-pol.	High Flex Leder	7S3FH083520001B06
ABITIG® 24G	4 m	DD	BSB 35-50 Tuchel 5-pol.	Standard	7S8SK043520001B06
	8 m	DD	BSB 35-50 Tuchel 5-pol.	Standard	7S8SK083520001B06
	4 m	DD	BSB 35-50 Tuchel 5-pol.	High Flex Leder	7S8SH043520001B06
	8 m	DD	BSB 35-50 Tuchel 5-pol.	High Flex Leder	7S8SH083520001B06
ABITIG® 24G Little	4 m	DD	BSB 35-50 Tuchel 5-pol.	High Flex Leder	7L8SH043520001B06
	8 m	DD	BSB 35-50 Tuchel 5-pol.	High Flex Leder	7L8SH083520001B06
ABITIG® 200	4 m	DD	BSB 35-50 Tuchel 5-pol.	Standard	7T4SK043520001B06
	8 m	DD	BSB 35-50 Tuchel 5-pol.	Standard	7T4SK083520001B06
	4 m	DD	BSB 35-50 Tuchel 5-pol.	High Flex Leder	7T4SH043520001B06
	8 m	DD	BSB 35-50 Tuchel 5-pol.	High Flex Leder	7T4SH083520001B06
ABITIG® 200F	4 m	DD	BSB 35-50 Tuchel 5-pol.	Standard	7T4FK043520001B06
	8 m	DD	BSB 35-50 Tuchel 5-pol.	Standard	7T4FK083520001B06
	4 m	DD	BSB 35-50 Tuchel 5-pol.	High Flex Leder	7T4FH043520001B06
	8 m	DD	BSB 35-50 Tuchel 5-pol.	High Flex Leder	7T4FH083520001B06
ABITIG® 150	4 m	DD	BSB 35-50 Tuchel 5-pol.	Standard	7T6SK043520001B06
	8 m	DD	BSB 35-50 Tuchel 5-pol.	Standard	7T6SK083520001B06
	4 m	DD	BSB 35-50 Tuchel 5-pol.	High Flex Leder	7T6SH043520001B06
	8 m	DD	BSB 35-50 Tuchel 5-pol.	High Flex Leder	7T6SH083520001B06
ABITIG® 150 Little	4 m	DD	BSB 35-50 Tuchel 5-pol.	High Flex Leder	7L6SH043520001B06
	8 m	DD	BSB 35-50 Tuchel 5-pol.	High Flex Leder	7L6SH083520001B06
ABITIG® 150F	4 m	DD	BSB 35-50 Tuchel 5-pol.	Standard	7T6FK043520001B06
	8 m	DD	BSB 35-50 Tuchel 5-pol.	Standard	7T6FK083520001B06
	4 m	DD	BSB 35-50 Tuchel 5-pol.	High Flex Leder	7T6FH043520001B06
	8 m	DD	BSB 35-50 Tuchel 5-pol.	High Flex Leder	7T6FH083520001B06
ABITIG® 150F Little	4 m	DD	BSB 35-50 Tuchel 5-pol.	High Flex Leder	7L6FH043520001B06
	8 m	DD	BSB 35-50 Tuchel 5-pol.	High Flex Leder	7L6FH083520001B06

ABITIG® GRIP / ABITIG® GRIP Little-Brennerpreisliste

passend für WIG-Stromquellen des Fabrikates „jäckle“



Brennertyp	Länge	Schalterfunktion	maschinenseitiger Anschluss	Schlauchpaketausführung	Bestellnummer
ABITIG® 9	4 m	EDP	BSB 35-50 Tuchel 7-pol.	Standard	7S1SK046540027C06
	8 m	EDP	BSB 35-50 Tuchel 7-pol.	Standard	7S1SK086540027C06
	4 m	EDP	BSB 35-50 Tuchel 7-pol.	High Flex Leder	7S1SH046540027C06
	8 m	EDP	BSB 35-50 Tuchel 7-pol.	High Flex Leder	7S1SH086540027C06
ABITIG® 9F	4 m	EDP	BSB 35-50 Tuchel 7-pol.	Standard	7S1FK046540027C06
	8 m	EDP	BSB 35-50 Tuchel 7-pol.	Standard	7S1FK086540027C06
	4 m	EDP	BSB 35-50 Tuchel 7-pol.	High Flex Leder	7S1FH046540027C06
	8 m	EDP	BSB 35-50 Tuchel 7-pol.	High Flex Leder	7S1FH086540027C06
ABITIG® 17	4 m	EDP	BSB 35-50 Tuchel 7-pol.	Standard	7S2SK046540027C06
	8 m	EDP	BSB 35-50 Tuchel 7-pol.	Standard	7S2SK086540027C06
	4 m	EDP	BSB 35-50 Tuchel 7-pol.	High Flex Leder	7S2SH046540027C06
	8 m	EDP	BSB 35-50 Tuchel 7-pol.	High Flex Leder	7S2SH086540027C06
ABITIG® 17F	4 m	EDP	BSB 35-50 Tuchel 7-pol.	Standard	7S2FK046540027C06
	8 m	EDP	BSB 35-50 Tuchel 7-pol.	Standard	7S2FK086540027C06
	4 m	EDP	BSB 35-50 Tuchel 7-pol.	High Flex Leder	7S2FH046540027C06
	8 m	EDP	BSB 35-50 Tuchel 7-pol.	High Flex Leder	7S2FH086540027C06

Technische Änderungen vorbehalten • Verkaufspreise = unverbindliche Preisempfehlung - Angebot freibleibend • © Copyright

ABITIG® GRIP / ABITIG® GRIP Little-Brennerpreisliste

passend für WIG-Stromquellen des Fabrikates „jäckle“

Brennertyp	Länge	Schalterfunktion	maschinenseitiger Anschluss	Schlauchpaketausführung	Bestellnummer
ABITIG® 26	4 m	EDP	BSB 35-50 Tuchel 7-pol.	Standard	7S3SK046540027C06
	8 m	EDP	BSB 35-50 Tuchel 7-pol.	Standard	7S3SK086540027C06
	4 m	EDP	BSB 35-50 Tuchel 7-pol.	High Flex Leder	7S3SH046540027C06
	8 m	EDP	BSB 35-50 Tuchel 7-pol.	High Flex Leder	7S3SH086540027C06
ABITIG® 26F	4 m	EDP	BSB 35-50 Tuchel 7-pol.	Standard	7S3FK046540027C06
	8 m	EDP	BSB 35-50 Tuchel 7-pol.	Standard	7S3FK086540027C06
	4 m	EDP	BSB 35-50 Tuchel 7-pol.	High Flex Leder	7S3FH046540027C06
	8 m	EDP	BSB 35-50 Tuchel 7-pol.	High Flex Leder	7S3FH086540027C06
ABITIG® 24G	4 m	EDP	BSB 35-50 Tuchel 7-pol.	Standard	7S8SK046540027C06
	8 m	EDP	BSB 35-50 Tuchel 7-pol.	Standard	7S8SK086540027C06
	4 m	EDP	BSB 35-50 Tuchel 7-pol.	High Flex Leder	7S8SH046540027C06
	8 m	EDP	BSB 35-50 Tuchel 7-pol.	High Flex Leder	7S8SH086540027C06
ABITIG® 200	4 m	EDP	BSB 35-50 Tuchel 7-pol.	Standard	7T4SK046540027C06
	8 m	EDP	BSB 35-50 Tuchel 7-pol.	Standard	7T4SK086540027C06
	4 m	EDP	BSB 35-50 Tuchel 7-pol.	High Flex Leder	7T4SH046540027C06
	8 m	EDP	BSB 35-50 Tuchel 7-pol.	High Flex Leder	7T4SH086540027C06
ABITIG® 200F	4 m	EDP	BSB 35-50 Tuchel 7-pol.	Standard	7T4FK046540027C06
	8 m	EDP	BSB 35-50 Tuchel 7-pol.	Standard	7T4FK086540027C06
	4 m	EDP	BSB 35-50 Tuchel 7-pol.	High Flex Leder	7T4FH046540027C06
	8 m	EDP	BSB 35-50 Tuchel 7-pol.	High Flex Leder	7T4FH086540027C06
ABITIG® 150	4 m	EDP	BSB 35-50 Tuchel 7-pol.	Standard	7T6SK046540027C06
	8 m	EDP	BSB 35-50 Tuchel 7-pol.	Standard	7T6SK086540027C06
	4 m	EDP	BSB 35-50 Tuchel 7-pol.	High Flex Leder	7T6SH046540027C06
	8 m	EDP	BSB 35-50 Tuchel 7-pol.	High Flex Leder	7T6SH086540027C06
ABITIG® 150F	4 m	EDP	BSB 35-50 Tuchel 7-pol.	Standard	7T6FK046540027C06
	8 m	EDP	BSB 35-50 Tuchel 7-pol.	Standard	7T6FK086540027C06
	4 m	EDP	BSB 35-50 Tuchel 7-pol.	High Flex Leder	7T6FH046540027C06
	8 m	EDP	BSB 35-50 Tuchel 7-pol.	High Flex Leder	7T6FH086540027C06

ABITIG® GRIP / ABITIG® GRIP Little-Brennerpreisliste

passend für WIG-Stromquellen des Fabrikates „jäckle“



Brennertyp	Länge	Schalterfunktion	maschinenseitiger Anschluss	Schlauchpaketausführung	Bestellnummer
ABITIG® 9	4 m	DDP	BSB 35-50 Tuchel 7-pol.	Standard	7S1SK046540027D06
	8 m	DDP	BSB 35-50 Tuchel 7-pol.	Standard	7S1SK086540027D06
	4 m	DDP	BSB 35-50 Tuchel 7-pol.	High Flex Leder	7S1SH046540027D06
	8 m	DDP	BSB 35-50 Tuchel 7-pol.	High Flex Leder	7S1SH086540027D06
ABITIG® 9F	4 m	DDP	BSB 35-50 Tuchel 7-pol.	Standard	7S1FK046540027D06
	8 m	DDP	BSB 35-50 Tuchel 7-pol.	Standard	7S1FK086540027D06
	4 m	DDP	BSB 35-50 Tuchel 7-pol.	High Flex Leder	7S1FH046540027D06
	8 m	DDP	BSB 35-50 Tuchel 7-pol.	High Flex Leder	7S1FH086540027D06
ABITIG® 17	4 m	DDP	BSB 35-50 Tuchel 7-pol.	Standard	7S2SK046540027D06
	8 m	DDP	BSB 35-50 Tuchel 7-pol.	Standard	7S2SK086540027D06
	4 m	DDP	BSB 35-50 Tuchel 7-pol.	High Flex Leder	7S2SH046540027D06
	8 m	DDP	BSB 35-50 Tuchel 7-pol.	High Flex Leder	7S2SH086540027D06
ABITIG® 17F	4 m	DDP	BSB 35-50 Tuchel 7-pol.	Standard	7S2FK046540027D06
	8 m	DDP	BSB 35-50 Tuchel 7-pol.	Standard	7S2FK086540027D06
	4 m	DDP	BSB 35-50 Tuchel 7-pol.	High Flex Leder	7S2FH046540027D06
	8 m	DDP	BSB 35-50 Tuchel 7-pol.	High Flex Leder	7S2FH086540027D06

Technische Änderungen vorbehalten • Verkaufspreise = unverbindliche Preisempfehlung - Angebot freibleibend • © Copyright

ABITIG® GRIP / ABITIG® GRIP Little-Brennerpreisliste

passend für WIG-Stromquellen des Fabrikates „jäckle“

Brennertyp	Länge	Schalterfunktion	maschinenseitiger Anschluss	Schlauchpaketausführung	Bestellnummer
ABITIG® 26	4 m	DDP	BSB 35-50 Tuchel 7-pol.	Standard	7S3SK046540027D06
	8 m	DDP	BSB 35-50 Tuchel 7-pol.	Standard	7S3SK086540027D06
	4 m	DDP	BSB 35-50 Tuchel 7-pol.	High Flex Leder	7S3SH046540027D06
	8 m	DDP	BSB 35-50 Tuchel 7-pol.	High Flex Leder	7S3SH086540027D06
ABITIG® 26F	4 m	DDP	BSB 35-50 Tuchel 7-pol.	Standard	7S3FK046540027D06
	8 m	DDP	BSB 35-50 Tuchel 7-pol.	Standard	7S3FK086540027D06
	4 m	DDP	BSB 35-50 Tuchel 7-pol.	High Flex Leder	7S3FH046540027D06
	8 m	DDP	BSB 35-50 Tuchel 7-pol.	High Flex Leder	7S3FH086540027D06
ABITIG® 24G	4 m	DDP	BSB 35-50 Tuchel 7-pol.	Standard	7S8SK046540027D06
	8 m	DDP	BSB 35-50 Tuchel 7-pol.	Standard	7S8SK086540027D06
	4 m	DDP	BSB 35-50 Tuchel 7-pol.	High Flex Leder	7S8SH046540027D06
	8 m	DDP	BSB 35-50 Tuchel 7-pol.	High Flex Leder	7S8SH086540027D06
ABITIG® 200	4 m	DDP	BSB 35-50 Tuchel 7-pol.	Standard	7T4SK046540027D06
	8 m	DDP	BSB 35-50 Tuchel 7-pol.	Standard	7T4SK086540027D06
	4 m	DDP	BSB 35-50 Tuchel 7-pol.	High Flex Leder	7T4SH046540027D06
	8 m	DDP	BSB 35-50 Tuchel 7-pol.	High Flex Leder	7T4SH086540027D06
ABITIG® 200F	4 m	DDP	BSB 35-50 Tuchel 7-pol.	Standard	7T4FK046540027D06
	8 m	DDP	BSB 35-50 Tuchel 7-pol.	Standard	7T4FK086540027D06
	4 m	DDP	BSB 35-50 Tuchel 7-pol.	High Flex Leder	7T4FH046540027D06
	8 m	DDP	BSB 35-50 Tuchel 7-pol.	High Flex Leder	7T4FH086540027D06
ABITIG® 150	4 m	DDP	BSB 35-50 Tuchel 7-pol.	Standard	7T6SK046540027D06
	8 m	DDP	BSB 35-50 Tuchel 7-pol.	Standard	7T6SK086540027D06
	4 m	DDP	BSB 35-50 Tuchel 7-pol.	High Flex Leder	7T6SH046540027D06
	8 m	DDP	BSB 35-50 Tuchel 7-pol.	High Flex Leder	7T6SH086540027D06
ABITIG® 150F	4 m	DDP	BSB 35-50 Tuchel 7-pol.	Standard	7T6FK046540027D06
	8 m	DDP	BSB 35-50 Tuchel 7-pol.	Standard	7T6FK086540027D06
	4 m	DDP	BSB 35-50 Tuchel 7-pol.	High Flex Leder	7T6FH046540027D06
	8 m	DDP	BSB 35-50 Tuchel 7-pol.	High Flex Leder	7T6FH086540027D06

ABITIG® GRIP / ABITIG® GRIP Little-Brennerpreisliste

passend für WIG-Stromquellen des Fabrikates „jäckle“



Brennertyp	Länge	Schalterfunktion	maschinenseitiger Anschluss	Schlauchpaketausführung	Bestellnummer
ABITIG® 18	4 m	DD	BSB 35-50 Tuchel 5-pol.	Standard	7S4SK043520002B11
	8 m	DD	BSB 35-50 Tuchel 5-pol.	Standard	7S4SK083520002B11
	4 m	DD	BSB 35-50 Tuchel 5-pol.	High Flex Leder	7S4SH043520002B11
	8 m	DD	BSB 35-50 Tuchel 5-pol.	High Flex Leder	7S4SH083520002B11
ABITIG® 18F	4 m	DD	BSB 35-50 Tuchel 5-pol.	Standard	7S4FK043520002B11
	8 m	DD	BSB 35-50 Tuchel 5-pol.	Standard	7S4FK083520002B11
	4 m	DD	BSB 35-50 Tuchel 5-pol.	High Flex Leder	7S4FH043520002B11
	8 m	DD	BSB 35-50 Tuchel 5-pol.	High Flex Leder	7S4FH083520002B11
ABITIG® 20	4 m	DD	BSB 35-50 Tuchel 5-pol.	Standard	7S5SK043520002B11
	8 m	DD	BSB 35-50 Tuchel 5-pol.	Standard	7S5SK083520002B11
	4 m	DD	BSB 35-50 Tuchel 5-pol.	High Flex Leder	7S5SH043520002B11
	8 m	DD	BSB 35-50 Tuchel 5-pol.	High Flex Leder	7S5SH083520002B11
ABITIG® 20 Little	4 m	DD	BSB 35-50 Tuchel 5-pol.	High Flex Leder	7L5SH043520002B11
	8 m	DD	BSB 35-50 Tuchel 5-pol.	High Flex Leder	7L5SH083520002B11
ABITIG® 20F	4 m	DD	BSB 35-50 Tuchel 5-pol.	Standard	7S5FK043520002B11
	8 m	DD	BSB 35-50 Tuchel 5-pol.	Standard	7S5FK083520002B11
	4 m	DD	BSB 35-50 Tuchel 5-pol.	High Flex Leder	7S5FH043520002B11
	8 m	DD	BSB 35-50 Tuchel 5-pol.	High Flex Leder	7S5FH083520002B11
ABITIG® 20F Little	4 m	DD	BSB 35-50 Tuchel 5-pol.	High Flex Leder	7L5FH043520002B11
	8 m	DD	BSB 35-50 Tuchel 5-pol.	High Flex Leder	7L5FH083520002B11

Technische Änderungen vorbehalten • Verkaufspreise = unverbindliche Preisempfehlung - Angebot freibleibend • © Copyright

ABITIG® GRIP / ABITIG® GRIP Little-Brennerpreisliste

passend für WIG-Stromquellen des Fabrikates „jäckle“

Brennertyp	Länge	Schalterfunktion	maschinenseitiger Anschluss	Schlauchpaketausführung	Bestellnummer
ABITIG® 12-1	4 m	DD	BSB 35-50 Tuchel 5-pol.	Standard	7S6SK043520002B11
	8 m	DD	BSB 35-50 Tuchel 5-pol.	Standard	7S6SK083520002B11
	4 m	DD	BSB 35-50 Tuchel 5-pol.	High Flex Leder	7S6SH043520002B11
	8 m	DD	BSB 35-50 Tuchel 5-pol.	High Flex Leder	7S6SH083520002B11
ABITIG® 18SC	4 m	DD	BSB 35-50 Tuchel 5-pol.	Standard	7S7SK043520002B11
	8 m	DD	BSB 35-50 Tuchel 5-pol.	Standard	7S7SK083520002B11
	4 m	DD	BSB 35-50 Tuchel 5-pol.	High Flex Leder	7S7SH043520002B11
	8 m	DD	BSB 35-50 Tuchel 5-pol.	High Flex Leder	7S7SH083520002B11
ABITIG® 24W	4 m	DD	BSB 35-50 Tuchel 5-pol.	Standard	7S9SK043520002B11
	8 m	DD	BSB 35-50 Tuchel 5-pol.	Standard	7S9SK083520002B11
	4 m	DD	BSB 35-50 Tuchel 5-pol.	High Flex Leder	7S9SH043520002B11
	8 m	DD	BSB 35-50 Tuchel 5-pol.	High Flex Leder	7S9SH083520002B11
ABITIG® 24W Little	4 m	DD	BSB 35-50 Tuchel 5-pol.	High Flex Leder	7L9SH043520002B11
	8 m	DD	BSB 35-50 Tuchel 5-pol.	High Flex Leder	7L9SH083520002B11
ABITIG® 450W	4 m	DD	BSB 35-50 Tuchel 5-pol.	Standard	7T5SK043520102B11
	8 m	DD	BSB 35-50 Tuchel 5-pol.	Standard	7T5SK083520102B11
	4 m	DD	BSB 35-50 Tuchel 5-pol.	High Flex Leder	7T5SH043520102B11
	8 m	DD	BSB 35-50 Tuchel 5-pol.	High Flex Leder	7T5SH083520102B11
ABITIG® 260W	4 m	DD	BSB 35-50 Tuchel 5-pol.	Standard	7T7SK043520102B11
	8 m	DD	BSB 35-50 Tuchel 5-pol.	Standard	7T7SK083520102B11
	4 m	DD	BSB 35-50 Tuchel 5-pol.	High Flex Leder	7T7SH043520102B11
	8 m	DD	BSB 35-50 Tuchel 5-pol.	High Flex Leder	7T7SH083520102B11
ABITIG® 260W Little	4 m	DD	BSB 35-50 Tuchel 5-pol.	High Flex Leder	7L7SH043520102B11
	8 m	DD	BSB 35-50 Tuchel 5-pol.	High Flex Leder	7L7SH083520102B11
ABITIG® 450W SC	4 m	DD	BSB 35-50 Tuchel 5-pol.	Standard	
	8 m	DD	BSB 35-50 Tuchel 5-pol.	Standard	
	4 m	DD	BSB 35-50 Tuchel 5-pol.	High Flex Leder	7T8SH043520102B11
	8 m	DD	BSB 35-50 Tuchel 5-pol.	High Flex Leder	7T8SH083520102B11

ABITIG® GRIP / ABITIG® GRIP Little-Brennerpreisliste

passend für WIG-Stromquellen des Fabrikates „jäckle“



Brennertyp	Länge	Schalterfunktion	maschinenseitiger Anschluss	Schlauchpaketausführung	Bestellnummer
ABITIG® 18	4 m	EDP	BSB 35-50 Tuchel 7-pol.	Standard	7S4SK046540027C11
	8 m	EDP	BSB 35-50 Tuchel 7-pol.	Standard	7S4SK086540027C11
	4 m	EDP	BSB 35-50 Tuchel 7-pol.	High Flex Leder	7S4SH046540027C11
	8 m	EDP	BSB 35-50 Tuchel 7-pol.	High Flex Leder	7S4SH086540027C11
ABITIG® 18F	4 m	EDP	BSB 35-50 Tuchel 7-pol.	Standard	7S4FK046540027C11
	8 m	EDP	BSB 35-50 Tuchel 7-pol.	Standard	7S4FK086540027C11
	4 m	EDP	BSB 35-50 Tuchel 7-pol.	High Flex Leder	7S4FH046540027C11
	8 m	EDP	BSB 35-50 Tuchel 7-pol.	High Flex Leder	7S4FH086540027C11
ABITIG® 20	4 m	EDP	BSB 35-50 Tuchel 7-pol.	Standard	7S5SK046540027C11
	8 m	EDP	BSB 35-50 Tuchel 7-pol.	Standard	7S5SK086540027C11
	4 m	EDP	BSB 35-50 Tuchel 7-pol.	High Flex Leder	7S5SH046540027C11
	8 m	EDP	BSB 35-50 Tuchel 7-pol.	High Flex Leder	7S5SH086540027C11
ABITIG® 20F	4 m	EDP	BSB 35-50 Tuchel 7-pol.	Standard	7S5FK046540027C11
	8 m	EDP	BSB 35-50 Tuchel 7-pol.	Standard	7S5FK086540027C11
	4 m	EDP	BSB 35-50 Tuchel 7-pol.	High Flex Leder	7S5FH046540027C11
	8 m	EDP	BSB 35-50 Tuchel 7-pol.	High Flex Leder	7S5FH086540027C11

Technische Änderungen vorbehalten • Verkaufspreise = unverbindliche Preisempfehlung - Angebot freibleibend • © Copyright

ABITIG® GRIP / ABITIG® GRIP Little-Brennerpreisliste

passend für WIG-Stromquellen des Fabrikates „jäckle“

Brennertyp	Länge	Schalterfunktion	maschinenseitiger Anschluss	Schlauchpaketausführung	Bestellnummer
ABITIG® 12-1	4 m	EDP	BSB 35-50 Tuchel 7-pol.	Standard	7S6SK046540027C11
	8 m	EDP	BSB 35-50 Tuchel 7-pol.	Standard	7S6SK086540027C11
	4 m	EDP	BSB 35-50 Tuchel 7-pol.	High Flex Leder	7S6SH046540027C11
	8 m	EDP	BSB 35-50 Tuchel 7-pol.	High Flex Leder	7S6SH086540027C11
ABITIG® 18SC	4 m	EDP	BSB 35-50 Tuchel 7-pol.	Standard	7S7SK046540027C11
	8 m	EDP	BSB 35-50 Tuchel 7-pol.	Standard	7S7SK086540027C11
	4 m	EDP	BSB 35-50 Tuchel 7-pol.	High Flex Leder	7S7SH046540027C11
	8 m	EDP	BSB 35-50 Tuchel 7-pol.	High Flex Leder	7S7SH086540027C11
ABITIG® 24W	4 m	EDP	BSB 35-50 Tuchel 7-pol.	Standard	7S9SK046540027C11
	8 m	EDP	BSB 35-50 Tuchel 7-pol.	Standard	7S9SK086540027C11
	4 m	EDP	BSB 35-50 Tuchel 7-pol.	High Flex Leder	7S9SH046540027C11
	8 m	EDP	BSB 35-50 Tuchel 7-pol.	High Flex Leder	7S9SH086540027C11
ABITIG® 450W	4 m	EDP	BSB 35-50 Tuchel 7-pol.	Standard	7T5SK046540127C11
	8 m	EDP	BSB 35-50 Tuchel 7-pol.	Standard	7T5SK086540127C11
	4 m	EDP	BSB 35-50 Tuchel 7-pol.	High Flex Leder	7T5SH046540127C11
	8 m	EDP	BSB 35-50 Tuchel 7-pol.	High Flex Leder	7T5SH086540127C11
ABITIG® 260W	4 m	EDP	BSB 35-50 Tuchel 7-pol.	Standard	7T7SK046540127C11
	8 m	EDP	BSB 35-50 Tuchel 7-pol.	Standard	7T7SK086540127C11
	4 m	EDP	BSB 35-50 Tuchel 7-pol.	High Flex Leder	7T7SH046540127C11
	8 m	EDP	BSB 35-50 Tuchel 7-pol.	High Flex Leder	7T7SH086540127C11
ABITIG® 450W SC	4 m	EDP	BSB 35-50 Tuchel 7-pol.	Standard	
	8 m	EDP	BSB 35-50 Tuchel 7-pol.	Standard	
	4 m	EDP	BSB 35-50 Tuchel 7-pol.	High Flex Leder	7T8SH046540127C11
	8 m	EDP	BSB 35-50 Tuchel 7-pol.	High Flex Leder	7T8SH086540127C11

ABITIG® GRIP / ABITIG® GRIP Little-Brennerpreisliste

passend für WIG-Stromquellen des Fabrikates „jäckle“



Brennertyp	Länge	Schalterfunktion	maschinenseitiger Anschluss	Schlauchpaketausführung	Bestellnummer
ABITIG® 18	4 m	DDP	BSB 35-50 Tuchel 7-pol.	Standard	7S4SK046540027D11
	8 m	DDP	BSB 35-50 Tuchel 7-pol.	Standard	7S4SK086540027D11
	4 m	DDP	BSB 35-50 Tuchel 7-pol.	High Flex Leder	7S4SH046540027D11
	8 m	DDP	BSB 35-50 Tuchel 7-pol.	High Flex Leder	7S4SH086540027D11
ABITIG® 18F	4 m	DDP	BSB 35-50 Tuchel 7-pol.	Standard	7S4FK046540027D11
	8 m	DDP	BSB 35-50 Tuchel 7-pol.	Standard	7S4FK086540027D11
	4 m	DDP	BSB 35-50 Tuchel 7-pol.	High Flex Leder	7S4FH046540027D11
	8 m	DDP	BSB 35-50 Tuchel 7-pol.	High Flex Leder	7S4FH086540027D11
ABITIG® 20	4 m	DDP	BSB 35-50 Tuchel 7-pol.	Standard	7S5SK046540027D11
	8 m	DDP	BSB 35-50 Tuchel 7-pol.	Standard	7S5SK086540027D11
	4 m	DDP	BSB 35-50 Tuchel 7-pol.	High Flex Leder	7S5SH046540027D11
	8 m	DDP	BSB 35-50 Tuchel 7-pol.	High Flex Leder	7S5SH086540027D11
ABITIG® 20F	4 m	DDP	BSB 35-50 Tuchel 7-pol.	Standard	7S5FK046540027D11
	8 m	DDP	BSB 35-50 Tuchel 7-pol.	Standard	7S5FK086540027D11
	4 m	DDP	BSB 35-50 Tuchel 7-pol.	High Flex Leder	7S5FH046540027D11
	8 m	DDP	BSB 35-50 Tuchel 7-pol.	High Flex Leder	7S5FH086540027D11

Technische Änderungen vorbehalten • Verkaufspreise = unverbindliche Preisempfehlung - Angebot freibleibend • © Copyright

ABITIG® GRIP / ABITIG® GRIP Little-Brennerpreisliste

passend für WIG-Stromquellen des Fabrikates „jäckle“

Brennertyp	Länge	Schalterfunktion	maschinenseitiger Anschluss	Schlauchpaketausführung	Bestellnummer
ABITIG® 12-1	4 m	DDP	BSB 35-50 Tuchel 7-pol.	Standard	7S6SK046540027D11
	8 m	DDP	BSB 35-50 Tuchel 7-pol.	Standard	7S6SK086540027D11
	4 m	DDP	BSB 35-50 Tuchel 7-pol.	High Flex Leder	7S6SH046540027D11
	8 m	DDP	BSB 35-50 Tuchel 7-pol.	High Flex Leder	7S6SH086540027D11
ABITIG® 18SC	4 m	DDP	BSB 35-50 Tuchel 7-pol.	Standard	7S7SK046540027D11
	8 m	DDP	BSB 35-50 Tuchel 7-pol.	Standard	7S7SK086540027D11
	4 m	DDP	BSB 35-50 Tuchel 7-pol.	High Flex Leder	7S7SH046540027D11
	8 m	DDP	BSB 35-50 Tuchel 7-pol.	High Flex Leder	7S7SH086540027D11
ABITIG® 24W	4 m	DDP	BSB 35-50 Tuchel 7-pol.	Standard	7S9SK046540027D11
	8 m	DDP	BSB 35-50 Tuchel 7-pol.	Standard	7S9SK086540027D11
	4 m	DDP	BSB 35-50 Tuchel 7-pol.	High Flex Leder	7S9SH046540027D11
	8 m	DDP	BSB 35-50 Tuchel 7-pol.	High Flex Leder	7S9SH086540027D11
ABITIG® 450W	4 m	DDP	BSB 35-50 Tuchel 7-pol.	Standard	7T5SK046540127D11
	8 m	DDP	BSB 35-50 Tuchel 7-pol.	Standard	7T5SK086540127D11
	4 m	DDP	BSB 35-50 Tuchel 7-pol.	High Flex Leder	7T5SH046540127D11
	8 m	DDP	BSB 35-50 Tuchel 7-pol.	High Flex Leder	7T5SH086540127D11
ABITIG® 260W	4 m	DDP	BSB 35-50 Tuchel 7-pol.	Standard	7T7SK046540127D11
	8 m	DDP	BSB 35-50 Tuchel 7-pol.	Standard	7T7SK086540127D11
	4 m	DDP	BSB 35-50 Tuchel 7-pol.	High Flex Leder	7T7SH046540127D11
	8 m	DDP	BSB 35-50 Tuchel 7-pol.	High Flex Leder	7T7SH086540127D11
ABITIG® 450W SC	4 m	DDP	BSB 35-50 Tuchel 7-pol.	Standard	
	8 m	DDP	BSB 35-50 Tuchel 7-pol.	Standard	
	4 m	DDP	BSB 35-50 Tuchel 7-pol.	High Flex Leder	7T8SH046540127D11
	8 m	DDP	BSB 35-50 Tuchel 7-pol.	High Flex Leder	7T8SH086540127D11

ABITIG® GRIP / ABITIG® GRIP Little-Brennerpreisliste

passend für WIG-Stromquellen des Fabrikates „kemppi“

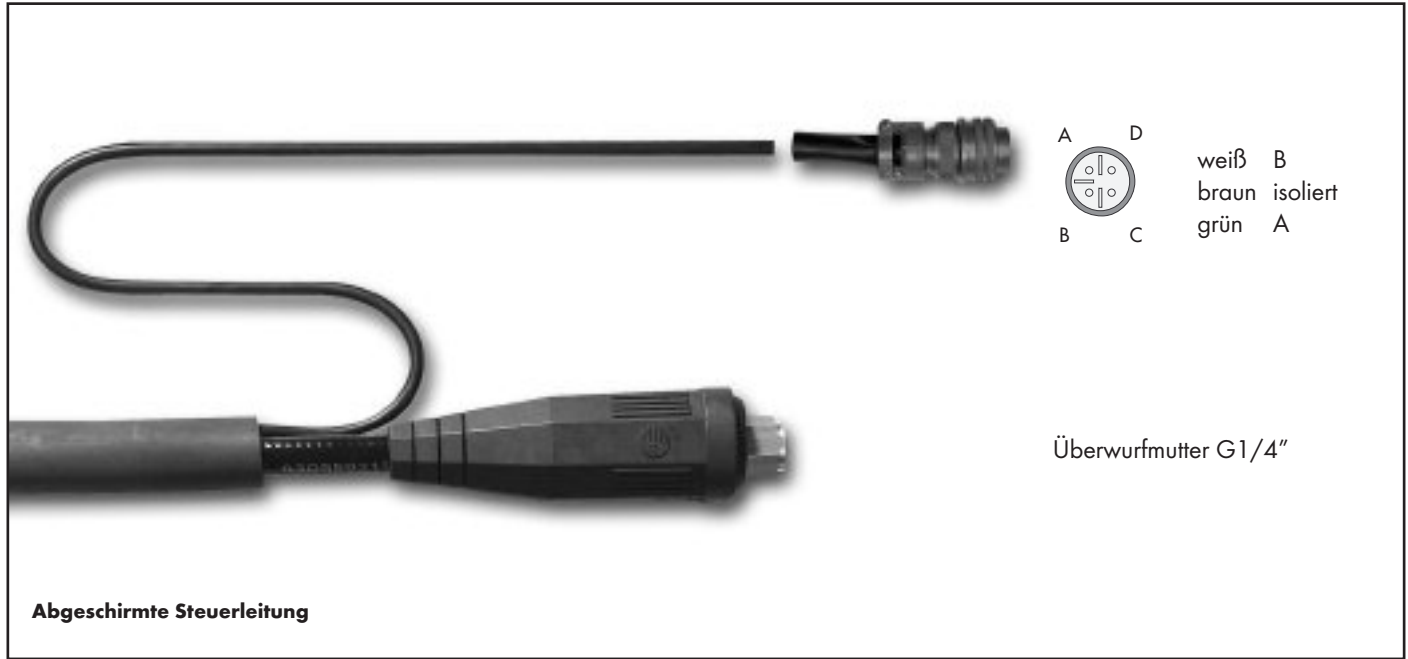

Brennertyp	Länge	Schalterfunktion	maschinenseitiger Anschluss	Schlauchpaketausführung	Bestellnummer
ABITIG® 9	4 m	ED	EA Amphenol 4-pol.	Standard	7S1SK047511110A00
	8 m	ED	EA Amphenol 4-pol.	Standard	7S1SK087511110A00
	4 m	ED	EA Amphenol 4-pol.	High Flex Leder	7S1SH047511110A00
	8 m	ED	EA Amphenol 4-pol.	High Flex Leder	7S1SH087511110A00
ABITIG® 9 Little	4 m	ED	EA Amphenol 4-pol.	High Flex Leder	7L1SH047511110A00
	8 m	ED	EA Amphenol 4-pol.	High Flex Leder	7L1SH087511110A00
ABITIG® 9F	4 m	ED	EA Amphenol 4-pol.	Standard	7S1FK047511110A00
	8 m	ED	EA Amphenol 4-pol.	Standard	7S1FK087511110A00
	4 m	ED	EA Amphenol 4-pol.	High Flex Leder	7S1FH047511110A00
	8 m	ED	EA Amphenol 4-pol.	High Flex Leder	7S1FH087511110A00
ABITIG® 9F Little	4 m	ED	EA Amphenol 4-pol.	High Flex Leder	7L1FH047511110A00
	8 m	ED	EA Amphenol 4-pol.	High Flex Leder	7L1FH087511110A00
ABITIG® 17	4 m	ED	EA Amphenol 4-pol.	Standard	7S2SK047511110A00
	8 m	ED	EA Amphenol 4-pol.	Standard	7S2SK087511110A00
	4 m	ED	EA Amphenol 4-pol.	High Flex Leder	7S2SH047511110A00
	8 m	ED	EA Amphenol 4-pol.	High Flex Leder	7S2SH087511110A00
ABITIG® 17 Little	4 m	ED	EA Amphenol 4-pol.	High Flex Leder	7L2SH047511110A00
	8 m	ED	EA Amphenol 4-pol.	High Flex Leder	7L2SH087511110A00
ABITIG® 17F	4 m	ED	EA Amphenol 4-pol.	Standard	7S2FK047511110A00
	8 m	ED	EA Amphenol 4-pol.	Standard	7S2FK087511110A00
	4 m	ED	EA Amphenol 4-pol.	High Flex Leder	7S2FH047511110A00
	8 m	ED	EA Amphenol 4-pol.	High Flex Leder	7S2FH087511110A00
ABITIG® 17F Little	4 m	ED	EA Amphenol 4-pol.	High Flex Leder	7L2FH047511110A00
	8 m	ED	EA Amphenol 4-pol.	High Flex Leder	7L2FH087511110A00

Technische Änderungen vorbehalten • Verkaufspreise = unverbindliche Preisempfehlung - Angebot freibleibend • © Copyright

ABITIG® GRIP / ABITIG® GRIP Little-Brennerpreisliste

passend für WIG-Stromquellen des Fabrikates „kemppi“

Brennertyp	Länge	Schalterfunktion	maschinenseitiger Anschluss	Schlauchpaketausführung	Bestellnummer
ABITIG® 26	4 m	ED	EA Amphenol 4-pol.	Standard	7S3SK047511110A00
	8 m	ED	EA Amphenol 4-pol.	Standard	7S3SK087511110A00
	4 m	ED	EA Amphenol 4-pol.	High Flex Leder	7S3SH047511110A00
	8 m	ED	EA Amphenol 4-pol.	High Flex Leder	7S3SH087511110A00
ABITIG® 26F	4 m	ED	EA Amphenol 4-pol.	Standard	7S3FK047511110A00
	8 m	ED	EA Amphenol 4-pol.	Standard	7S3FK087511110A00
	4 m	ED	EA Amphenol 4-pol.	High Flex Leder	7S3FH047511110A00
	8 m	ED	EA Amphenol 4-pol.	High Flex Leder	7S3FH087511110A00
ABITIG® 24G	4 m	ED	EA Amphenol 4-pol.	Standard	7S8SK047511110A00
	8 m	ED	EA Amphenol 4-pol.	Standard	7S8SK087511110A00
	4 m	ED	EA Amphenol 4-pol.	High Flex Leder	7S8SH047511110A00
	8 m	ED	EA Amphenol 4-pol.	High Flex Leder	7S8SH087511110A00
ABITIG® 24G Little	4 m	ED	EA Amphenol 4-pol.	High Flex Leder	7L8SH047511110A00
	8 m	ED	EA Amphenol 4-pol.	High Flex Leder	7L8SH087511110A00
ABITIG® 200	4 m	ED	EA Amphenol 4-pol.	Standard	7T4SK047511110A00
	8 m	ED	EA Amphenol 4-pol.	Standard	7T4SK087511110A00
	4 m	ED	EA Amphenol 4-pol.	High Flex Leder	7T4SH047511110A00
	8 m	ED	EA Amphenol 4-pol.	High Flex Leder	7T4SH087511110A00
ABITIG® 200F	4 m	ED	EA Amphenol 4-pol.	Standard	7T4FK047511110A00
	8 m	ED	EA Amphenol 4-pol.	Standard	7T4FK087511110A00
	4 m	ED	EA Amphenol 4-pol.	High Flex Leder	7T4FH047511110A00
	8 m	ED	EA Amphenol 4-pol.	High Flex Leder	7T4FH087511110A00
ABITIG® 150	4 m	ED	EA Amphenol 4-pol.	Standard	7T6SK047511110A00
	8 m	ED	EA Amphenol 4-pol.	Standard	7T6SK087511110A00
	4 m	ED	EA Amphenol 4-pol.	High Flex Leder	7T6SH047511110A00
	8 m	ED	EA Amphenol 4-pol.	High Flex Leder	7T6SH087511110A00
ABITIG® 150 Little	4 m	ED	EA Amphenol 4-pol.	High Flex Leder	7L6SH047511110A00
	8 m	ED	EA Amphenol 4-pol.	High Flex Leder	7L6SH087511110A00
ABITIG® 150F	4 m	ED	EA Amphenol 4-pol.	Standard	7T6FK047511110A00
	8 m	ED	EA Amphenol 4-pol.	Standard	7T6FK087511110A00
	4 m	ED	EA Amphenol 4-pol.	High Flex Leder	7T6FH047511110A00
	8 m	ED	EA Amphenol 4-pol.	High Flex Leder	7T6FH087511110A00
ABITIG® 150F Little	4 m	ED	EA Amphenol 4-pol.	High Flex Leder	7L6FH047511110A00
	8 m	ED	EA Amphenol 4-pol.	High Flex Leder	7L6FH087511110A00

ABITIG® GRIP / ABITIG® GRIP Little-Brennerpreisliste

passend für WIG-Stromquellen des Fabrikates „kemppi“



Abgeschirmte Steuerleitung

Brennertyp	Länge	Schalterfunktion	maschinenseitiger Anschluss	Schlauchpaketausführung	Bestellnummer
ABITIG® 9	4 m	ED	ZA 9-pol.	Standard	7S1SK047510799A00
	8 m	ED	ZA 9-pol.	Standard	7S1SK087510799A00
	4 m	ED	ZA 9-pol.	High Flex Leder	7S1SH047510799A00
	8 m	ED	ZA 9-pol.	High Flex Leder	7S1SH087510799A00
ABITIG® 9 Little	4 m	ED	ZA 9-pol.	High Flex Leder	7L1SH047510799A00
	8 m	ED	ZA 9-pol.	High Flex Leder	7L1SH087510799A00
ABITIG® 9F	4 m	ED	ZA 9-pol.	Standard	7S1FK047510799A00
	8 m	ED	ZA 9-pol.	Standard	7S1FK087510799A00
	4 m	ED	ZA 9-pol.	High Flex Leder	7S1FH047510799A00
	8 m	ED	ZA 9-pol.	High Flex Leder	7S1FH087510799A00
ABITIG® 9F Little	4 m	ED	ZA 9-pol.	High Flex Leder	7L1FH047510799A00
	8 m	ED	ZA 9-pol.	High Flex Leder	7L1FH087510799A00
ABITIG® 17	4 m	ED	ZA 9-pol.	Standard	7S2SK047510799A00
	8 m	ED	ZA 9-pol.	Standard	7S2SK087510799A00
	4 m	ED	ZA 9-pol.	High Flex Leder	7S2SH047510799A00
	8 m	ED	ZA 9-pol.	High Flex Leder	7S2SH087510799A00
ABITIG® 17 Little	4 m	ED	ZA 9-pol.	High Flex Leder	7L2SH047510799A00
	8 m	ED	ZA 9-pol.	High Flex Leder	7L2SH087510799A00
ABITIG® 17F	4 m	ED	ZA 9-pol.	Standard	7S2FK047510799A00
	8 m	ED	ZA 9-pol.	Standard	7S2FK087510799A00
	4 m	ED	ZA 9-pol.	High Flex Leder	7S2FH047510799A00
	8 m	ED	ZA 9-pol.	High Flex Leder	7S2FH087510799A00
ABITIG® 17F Little	4 m	ED	ZA 9-pol.	High Flex Leder	7L2FH047510799A00
	8 m	ED	ZA 9-pol.	High Flex Leder	7L2FH087510799A00

Technische Änderungen vorbehalten • Verkaufspreise = unverbindliche Preisempfehlung - Angebot freibleibend • © Copyright

ABITIG® GRIP / ABITIG® GRIP Little-Brennerpreisliste

passend für WIG-Stromquellen des Fabrikates „kemppi“

Brennertyp	Länge	Schalterfunktion	maschinenseitiger Anschluss	Schlauchpaketausführung	Bestellnummer
ABITIG® 26	4 m	ED	ZA 9-pol.	Standard	7S3SK047510799A00
	8 m	ED	ZA 9-pol.	Standard	7S3SK087510799A00
	4 m	ED	ZA 9-pol.	High Flex Leder	7S3SH047510799A00
	8 m	ED	ZA 9-pol.	High Flex Leder	7S3SH087510799A00
ABITIG® 26 F	4 m	ED	ZA 9-pol.	Standard	7S3FK047510799A00
	8 m	ED	ZA 9-pol.	Standard	7S3FK087510799A00
	4 m	ED	ZA 9-pol.	High Flex Leder	7S3FH047510799A00
	8 m	ED	ZA 9-pol.	High Flex Leder	7S3FH087510799A00
ABITIG® 24G	4 m	ED	ZA 9-pol.	Standard	7S8SK047510799A00
	8 m	ED	ZA 9-pol.	Standard	7S8SK087510799A00
	4 m	ED	ZA 9-pol.	High Flex Leder	7S8SH047510799A00
	8 m	ED	ZA 9-pol.	High Flex Leder	7S8SH087510799A00
ABITIG® 24G Little	4 m	ED	ZA 9-pol.	High Flex Leder	7L8SH047510799A00
	8 m	ED	ZA 9-pol.	High Flex Leder	7L8SH087510799A00
ABITIG® 200	4 m	ED	ZA 9-pol.	Standard	7T4SK047510799A00
	8 m	ED	ZA 9-pol.	Standard	7T4SK087510799A00
	4 m	ED	ZA 9-pol.	High Flex Leder	7T4SH047510799A00
	8 m	ED	ZA 9-pol.	High Flex Leder	7T4SH087510799A00
ABITIG® 200F	4 m	ED	ZA 9-pol.	Standard	7T4FK047510799A00
	8 m	ED	ZA 9-pol.	Standard	7T4FK087510799A00
	4 m	ED	ZA 9-pol.	High Flex Leder	7T4FH047510799A00
	8 m	ED	ZA 9-pol.	High Flex Leder	7T4FH087510799A00
ABITIG® 150	4 m	ED	ZA 9-pol.	Standard	7T6SK047510799A00
	8 m	ED	ZA 9-pol.	Standard	7T6SK087510799A00
	4 m	ED	ZA 9-pol.	High Flex Leder	7T6SH047510799A00
	8 m	ED	ZA 9-pol.	High Flex Leder	7T6SH087510799A00
ABITIG® 150 Little	4 m	ED	ZA 9-pol.	High Flex Leder	7L6SH047510799A00
	8 m	ED	ZA 9-pol.	High Flex Leder	7L6SH087510799A00
ABITIG® 150F	4 m	ED	ZA 9-pol.	Standard	7T6FK047510799A00
	8 m	ED	ZA 9-pol.	Standard	7T6FK087510799A00
	4 m	ED	ZA 9-pol.	High Flex Leder	7T6FH047510799A00
	8 m	ED	ZA 9-pol.	High Flex Leder	7T6FH087510799A00
ABITIG® 150F Little	4 m	ED	ZA 9-pol.	High Flex Leder	7L6FH047510799A00
	8 m	ED	ZA 9-pol.	High Flex Leder	7L6FH087510799A00

ABITIG® GRIP / ABITIG® GRIP Little-Brennerpreisliste

passend für WIG-Stromquellen des Fabrikates „kemppi“



Brennertyp	Länge	Schalterfunktion	maschinenseitiger Anschluss	Schlauchpaketausführung	Bestellnummer
ABITIG® 9	4 m	EDP	EA Amphenol 4-pol. + Amphenol 10-pol.	Standard	7S1SK047541131A00
	8 m	EDP	EA Amphenol 4-pol. + Amphenol 10-pol.	Standard	7S1SK087541131A00
	4 m	EDP	EA Amphenol 4-pol. + Amphenol 10-pol.	High Flex Leder	7S1SH047541131A00
	8 m	EDP	EA Amphenol 4-pol. + Amphenol 10-pol.	High Flex Leder	7S1SH087541131A00
ABITIG® 9F	4 m	EDP	EA Amphenol 4-pol. + Amphenol 10-pol.	Standard	7S1FK047541131A00
	8 m	EDP	EA Amphenol 4-pol. + Amphenol 10-pol.	Standard	7S1FK087541131A00
	4 m	EDP	EA Amphenol 4-pol. + Amphenol 10-pol.	High Flex Leder	7S1FH047541131A00
	8 m	EDP	EA Amphenol 4-pol. + Amphenol 10-pol.	High Flex Leder	7S1FH087541131A00
ABITIG® 17	4 m	EDP	EA Amphenol 4-pol. + Amphenol 10-pol.	Standard	7S2SK047541131A00
	8 m	EDP	EA Amphenol 4-pol. + Amphenol 10-pol.	Standard	7S2SK087541131A00
	4 m	EDP	EA Amphenol 4-pol. + Amphenol 10-pol.	High Flex Leder	7S2SH047541131A00
	8 m	EDP	EA Amphenol 4-pol. + Amphenol 10-pol.	High Flex Leder	7S2SH087541131A00
ABITIG® 17F	4 m	EDP	EA Amphenol 4-pol. + Amphenol 10-pol.	Standard	7S2FK047541131A00
	8 m	EDP	EA Amphenol 4-pol. + Amphenol 10-pol.	Standard	7S2FK087541131A00
	4 m	EDP	EA Amphenol 4-pol. + Amphenol 10-pol.	High Flex Leder	7S2FH047541131A00
	8 m	EDP	EA Amphenol 4-pol. + Amphenol 10-pol.	High Flex Leder	7S2FH087541131A00

Technische Änderungen vorbehalten • Verkaufspreise = unverbindliche Preisempfehlung - Angebot freibleibend • © Copyright

ABITIG® GRIP / ABITIG® GRIP Little-Brennerpreisliste

passend für WIG-Stromquellen des Fabrikates „kempfi“

Brennertyp	Länge	Schalterfunktion	maschinenseitiger Anschluss	Schlauchpaketausführung	Bestellnummer
ABITIG® 26	4 m	EDP	EA Amphenol 4-pol. + Amphenol 10-pol.	Standard	7S3SK047541131A00
	8 m	EDP	EA Amphenol 4-pol. + Amphenol 10-pol.	Standard	7S3SK087541131A00
	4 m	EDP	EA Amphenol 4-pol. + Amphenol 10-pol.	High Flex Leder	7S3SH047541131A00
	8 m	EDP	EA Amphenol 4-pol. + Amphenol 10-pol.	High Flex Leder	7S3SH087541131A00
ABITIG® 26F	4 m	EDP	EA Amphenol 4-pol. + Amphenol 10-pol.	Standard	7S3FK047541131A00
	8 m	EDP	EA Amphenol 4-pol. + Amphenol 10-pol.	Standard	7S3FK087541131A00
	4 m	EDP	EA Amphenol 4-pol. + Amphenol 10-pol.	High Flex Leder	7S3FH047541131A00
	8 m	EDP	EA Amphenol 4-pol. + Amphenol 10-pol.	High Flex Leder	7S3FH087541131A00
ABITIG® 24G	4 m	EDP	EA Amphenol 4-pol. + Amphenol 10-pol.	Standard	7S8SK047541131A00
	8 m	EDP	EA Amphenol 4-pol. + Amphenol 10-pol.	Standard	7S8SK087541131A00
	4 m	EDP	EA Amphenol 4-pol. + Amphenol 10-pol.	High Flex Leder	7S8SH047541131A00
	8 m	EDP	EA Amphenol 4-pol. + Amphenol 10-pol.	High Flex Leder	7S8SH087541131A00
ABITIG® 200	4 m	EDP	EA Amphenol 4-pol. + Amphenol 10-pol.	Standard	7T4SK047541131A00
	8 m	EDP	EA Amphenol 4-pol. + Amphenol 10-pol.	Standard	7T4SK087541131A00
	4 m	EDP	EA Amphenol 4-pol. + Amphenol 10-pol.	High Flex Leder	7T4SH047541131A00
	8 m	EDP	EA Amphenol 4-pol. + Amphenol 10-pol.	High Flex Leder	7T4SH087541131A00
ABITIG® 200F	4 m	EDP	EA Amphenol 4-pol. + Amphenol 10-pol.	Standard	7T4FK047541131A00
	8 m	EDP	EA Amphenol 4-pol. + Amphenol 10-pol.	Standard	7T4FK087541131A00
	4 m	EDP	EA Amphenol 4-pol. + Amphenol 10-pol.	High Flex Leder	7T4FH047541131A00
	8 m	EDP	EA Amphenol 4-pol. + Amphenol 10-pol.	High Flex Leder	7T4FH087541131A00
ABITIG® 150	4 m	EDP	EA Amphenol 4-pol. + Amphenol 10-pol.	Standard	7T6SK047541131A00
	8 m	EDP	EA Amphenol 4-pol. + Amphenol 10-pol.	Standard	7T6SK087541131A00
	4 m	EDP	EA Amphenol 4-pol. + Amphenol 10-pol.	High Flex Leder	7T6SH047541131A00
	8 m	EDP	EA Amphenol 4-pol. + Amphenol 10-pol.	High Flex Leder	7T6SH087541131A00
ABITIG® 150F	4 m	EDP	EA Amphenol 4-pol. + Amphenol 10-pol.	Standard	7T6FK047541131A00
	8 m	EDP	EA Amphenol 4-pol. + Amphenol 10-pol.	Standard	7T6FK087541131A00
	4 m	EDP	EA Amphenol 4-pol. + Amphenol 10-pol.	High Flex Leder	7T6FH047541131A00
	8 m	EDP	EA Amphenol 4-pol. + Amphenol 10-pol.	High Flex Leder	7T6FH087541131A00

ABITIG® GRIP / ABITIG® GRIP Little-Brennerpreisliste

passend für WIG-Stromquellen des Fabrikates „kemppi“

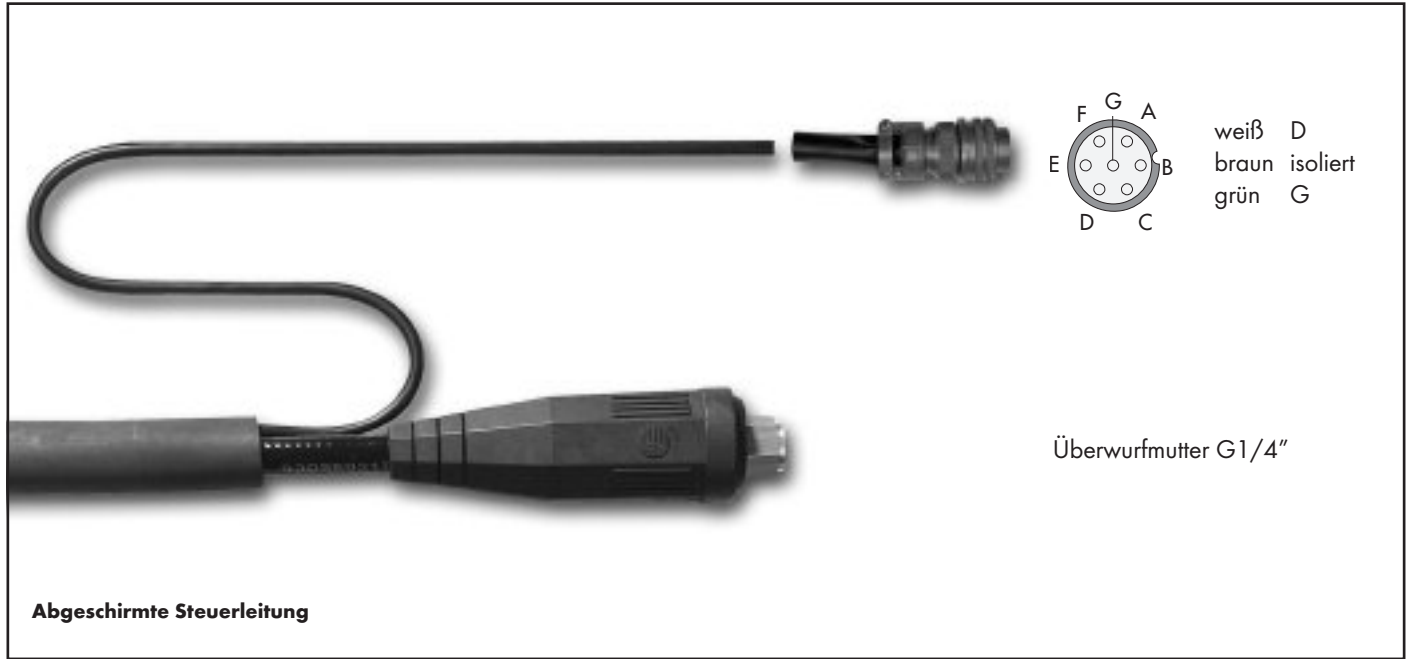

Brennertyp	Länge	Schalterfunktion	maschinenseitiger Anschluss	Schlauchpaketausführung	Bestellnummer
ABITIG® 9	4 m	ED	EA Amphenol 7-pol.	Standard	7S1SK047511146A00
	8 m	ED	EA Amphenol 7-pol.	Standard	7S1SK087511146A00
	4 m	ED	EA Amphenol 7-pol.	High Flex Leder	7S1SH047511146A00
	8 m	ED	EA Amphenol 7-pol.	High Flex Leder	7S1SH087511146A00
ABITIG® 9 Little	4 m	ED	EA Amphenol 7-pol.	High Flex Leder	7L1SH047511146A00
	8 m	ED	EA Amphenol 7-pol.	High Flex Leder	7L1SH087511146A00
ABITIG® 9F	4 m	ED	EA Amphenol 7-pol.	Standard	7S1FK047511146A00
	8 m	ED	EA Amphenol 7-pol.	Standard	7S1FK087511146A00
	4 m	ED	EA Amphenol 7-pol.	High Flex Leder	7S1FH047511146A00
	8 m	ED	EA Amphenol 7-pol.	High Flex Leder	7S1FH087511146A00
ABITIG® 9F Little	4 m	ED	EA Amphenol 7-pol.	High Flex Leder	7L1FH047511146A00
	8 m	ED	EA Amphenol 7-pol.	High Flex Leder	7L1FH087511146A00
ABITIG® 17	4 m	ED	EA Amphenol 7-pol.	Standard	7S2SK047511146A00
	8 m	ED	EA Amphenol 7-pol.	Standard	7S2SK087511146A00
	4 m	ED	EA Amphenol 7-pol.	High Flex Leder	7S2SH047511146A00
	8 m	ED	EA Amphenol 7-pol.	High Flex Leder	7S2SH087511146A00
ABITIG® 17 Little	4 m	ED	EA Amphenol 7-pol.	High Flex Leder	7L2SH047511146A00
	8 m	ED	EA Amphenol 7-pol.	High Flex Leder	7L2SH087511146A00
ABITIG® 17F	4 m	ED	EA Amphenol 7-pol.	Standard	7S2FK047511146A00
	8 m	ED	EA Amphenol 7-pol.	Standard	7S2FK087511146A00
	4 m	ED	EA Amphenol 7-pol.	High Flex Leder	7S2FH047511146A00
	8 m	ED	EA Amphenol 7-pol.	High Flex Leder	7S2FH087511146A00
ABITIG® 17F Little	4 m	ED	EA Amphenol 7-pol.	High Flex Leder	7L2FH047511146A00
	8 m	ED	EA Amphenol 7-pol.	High Flex Leder	7L2FH087511146A00

Technische Änderungen vorbehalten • Verkaufspreise = unverbindliche Preisempfehlung - Angebot freibleibend • © Copyright

ABITIG® GRIP / ABITIG® GRIP Little-Brennerpreisliste

passend für WIG-Stromquellen des Fabrikates „kemppi“

Brennertyp	Länge	Schalterfunktion	maschinenseitiger Anschluss	Schlauchpaket-ausführung	Bestellnummer
ABITIG® 26	4 m	ED	EA Amphenol 7-pol.	Standard	7S3SK047511146A00
	8 m	ED	EA Amphenol 7-pol.	Standard	7S3SK087511146A00
	4 m	ED	EA Amphenol 7-pol.	High Flex Leder	7S3SH047511146A00
	8 m	ED	EA Amphenol 7-pol.	High Flex Leder	7S3SH087511146A00
ABITIG® 26F	4 m	ED	EA Amphenol 7-pol.	Standard	7S3FK047511146A00
	8 m	ED	EA Amphenol 7-pol.	Standard	7S3FK087511146A00
	4 m	ED	EA Amphenol 7-pol.	High Flex Leder	7S3FH047511146A00
	8 m	ED	EA Amphenol 7-pol.	High Flex Leder	7S3FH087511146A00
ABITIG® 24G	4 m	ED	EA Amphenol 7-pol.	Standard	7S8SK047511146A00
	8 m	ED	EA Amphenol 7-pol.	Standard	7S8SK087511146A00
	4 m	ED	EA Amphenol 7-pol.	High Flex Leder	7S8SH047511146A00
	8 m	ED	EA Amphenol 7-pol.	High Flex Leder	7S8SH087511146A00
ABITIG® 24G Little	4 m	ED	EA Amphenol 7-pol.	High Flex Leder	7L8SH047511146A00
	8 m	ED	EA Amphenol 7-pol.	High Flex Leder	7L8SH087511146A00
ABITIG® 200	4 m	ED	EA Amphenol 7-pol.	Standard	7T4SK047511146A00
	8 m	ED	EA Amphenol 7-pol.	Standard	7T4SK087511146A00
	4 m	ED	EA Amphenol 7-pol.	High Flex Leder	7T4SH047511146A00
	8 m	ED	EA Amphenol 7-pol.	High Flex Leder	7T4SH087511146A00
ABITIG® 200F	4 m	ED	EA Amphenol 7-pol.	Standard	7T4FK047511146A00
	8 m	ED	EA Amphenol 7-pol.	Standard	7T4FK087511146A00
	4 m	ED	EA Amphenol 7-pol.	High Flex Leder	7T4FH047511146A00
	8 m	ED	EA Amphenol 7-pol.	High Flex Leder	7T4FH087511146A00
ABITIG® 150	4 m	ED	EA Amphenol 7-pol.	Standard	7T6SK047511146A00
	8 m	ED	EA Amphenol 7-pol.	Standard	7T6SK087511146A00
	4 m	ED	EA Amphenol 7-pol.	High Flex Leder	7T6SH047511146A00
	8 m	ED	EA Amphenol 7-pol.	High Flex Leder	7T6SH087511146A00
ABITIG® 150 Little	4 m	ED	EA Amphenol 7-pol.	High Flex Leder	7L6SH047511146A00
	8 m	ED	EA Amphenol 7-pol.	High Flex Leder	7L6SH087511146A00
ABITIG® 150F	4 m	ED	EA Amphenol 7-pol.	Standard	7T6FK047511146A00
	8 m	ED	EA Amphenol 7-pol.	Standard	7T6FK087511146A00
	4 m	ED	EA Amphenol 7-pol.	High Flex Leder	7T6FH047511146A00
	8 m	ED	EA Amphenol 7-pol.	High Flex Leder	7T6FH087511146A00
ABITIG® 150F Little	4 m	ED	EA Amphenol 7-pol.	High Flex Leder	7L6FH047511146A00
	8 m	ED	EA Amphenol 7-pol.	High Flex Leder	7L6FH087511146A00

ABITIG® GRIP / ABITIG® GRIP Little-Brennerpreisliste

passend für WIG-Stromquellen des Fabrikates „kemppi“



Brennertyp	Länge	Schalterfunktion	maschinenseitiger Anschluss	Schlauchpaketausführung	Bestellnummer
ABITIG® 9	4 m	EDP	EA Amphenol 7-pol.	Standard	7S1SK047541146C00
	8 m	EDP	EA Amphenol 7-pol.	Standard	7S1SK087541146C00
	4 m	EDP	EA Amphenol 7-pol.	High Flex Leder	7S1SH047541146C00
	8 m	EDP	EA Amphenol 7-pol.	High Flex Leder	7S1SH087541146C00
ABITIG® 9F	4 m	EDP	EA Amphenol 7-pol.	Standard	7S1FK047541146C00
	8 m	EDP	EA Amphenol 7-pol.	Standard	7S1FK087541146C00
	4 m	EDP	EA Amphenol 7-pol.	High Flex Leder	7S1FH047541146C00
	8 m	EDP	EA Amphenol 7-pol.	High Flex Leder	7S1FH087541146C00
ABITIG® 17	4 m	EDP	EA Amphenol 7-pol.	Standard	7S2SK047541146C00
	8 m	EDP	EA Amphenol 7-pol.	Standard	7S2SK087541146C00
	4 m	EDP	EA Amphenol 7-pol.	High Flex Leder	7S2SH047541146C00
	8 m	EDP	EA Amphenol 7-pol.	High Flex Leder	7S2SH087541146C00
ABITIG® 17F	4 m	EDP	EA Amphenol 7-pol.	Standard	7S2FK047541146C00
	8 m	EDP	EA Amphenol 7-pol.	Standard	7S2FK087541146C00
	4 m	EDP	EA Amphenol 7-pol.	High Flex Leder	7S2FH047541146C00
	8 m	EDP	EA Amphenol 7-pol.	High Flex Leder	7S2FH087541146C00

Technische Änderungen vorbehalten • Verkaufspreise = unverbindliche Preisempfehlung - Angebot freibleibend • © Copyright

ABITIG® GRIP / ABITIG® GRIP Little-Brennerpreisliste

passend für WIG-Stromquellen des Fabrikates „kemppi“

Brennertyp	Länge	Schalterfunktion	maschinenseitiger Anschluss	Schlauchpaketausführung	Bestellnummer
ABITIG® 26	4 m	EDP	EA Amphenol 7-pol.	Standard	7S3SK047541146C00
	8 m	EDP	EA Amphenol 7-pol.	Standard	7S3SK087541146C00
	4 m	EDP	EA Amphenol 7-pol.	High Flex Leder	7S3SH047541146C00
	8 m	EDP	EA Amphenol 7-pol.	High Flex Leder	7S3SH087541146C00
ABITIG® 26F	4 m	EDP	EA Amphenol 7-pol.	Standard	7S3FK047541146C00
	8 m	EDP	EA Amphenol 7-pol.	Standard	7S3FK087541146C00
	4 m	EDP	EA Amphenol 7-pol.	High Flex Leder	7S3FH047541146C00
	8 m	EDP	EA Amphenol 7-pol.	High Flex Leder	7S3FH087541146C00
ABITIG® 24G	4 m	EDP	EA Amphenol 7-pol.	Standard	7S8SK047541146C00
	8 m	EDP	EA Amphenol 7-pol.	Standard	7S8SK087541146C00
	4 m	EDP	EA Amphenol 7-pol.	High Flex Leder	7S8SH047541146C00
	8 m	EDP	EA Amphenol 7-pol.	High Flex Leder	7S8SH087541146C00
ABITIG® 200	4 m	EDP	EA Amphenol 7-pol.	Standard	7T4SK047541146C00
	8 m	EDP	EA Amphenol 7-pol.	Standard	7T4SK087541146C00
	4 m	EDP	EA Amphenol 7-pol.	High Flex Leder	7T4SH047541146C00
	8 m	EDP	EA Amphenol 7-pol.	High Flex Leder	7T4SH087541146C00
ABITIG® 200F	4 m	EDP	EA Amphenol 7-pol.	Standard	7T4FK047541146C00
	8 m	EDP	EA Amphenol 7-pol.	Standard	7T4FK087541146C00
	4 m	EDP	EA Amphenol 7-pol.	High Flex Leder	7T4FH047541146C00
	8 m	EDP	EA Amphenol 7-pol.	High Flex Leder	7T4FH087541146C00
ABITIG® 150	4 m	EDP	EA Amphenol 7-pol.	Standard	7T6SK047541146C00
	8 m	EDP	EA Amphenol 7-pol.	Standard	7T6SK087541146C00
	4 m	EDP	EA Amphenol 7-pol.	High Flex Leder	7T6SH047541146C00
	8 m	EDP	EA Amphenol 7-pol.	High Flex Leder	7T6SH087541146C00
ABITIG® 150F	4 m	EDP	EA Amphenol 7-pol.	Standard	7T6FK047541146C00
	8 m	EDP	EA Amphenol 7-pol.	Standard	7T6FK087541146C00
	4 m	EDP	EA Amphenol 7-pol.	High Flex Leder	7T6FH047541146C00
	8 m	EDP	EA Amphenol 7-pol.	High Flex Leder	7T6FH087541146C00

ABITIG® GRIP / ABITIG® GRIP Little-Brennerpreisliste

passend für WIG-Stromquellen des Fabrikates „kemppi“ Up/Down

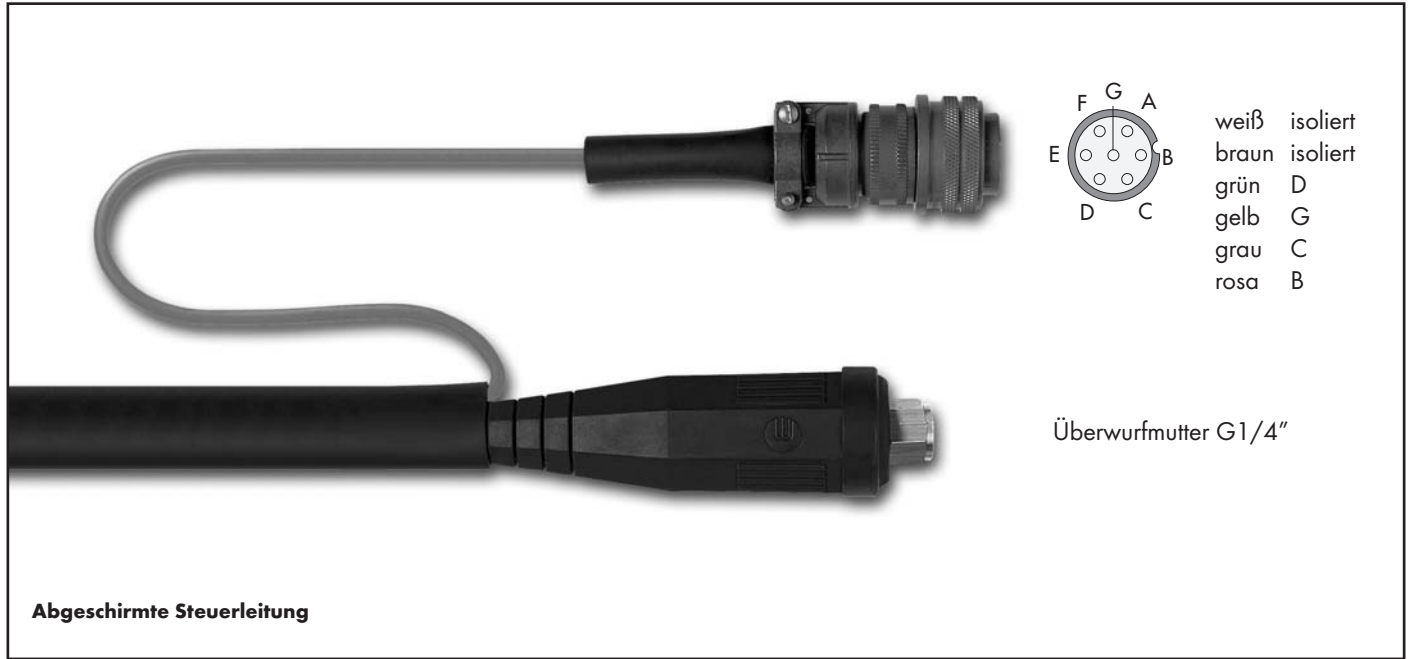

Brennertyp	Länge	Schalterfunktion	maschinenseitiger Anschluss	Schlauchpaketausführung	Bestellnummer
ABITIG® 9	4 m	UD	EA Amphenol 7-pol.	Standard	7S1SK047651132B00
	8 m	UD	EA Amphenol 7-pol.	Standard	7S1SK087651132B00
	4 m	UD	EA Amphenol 7-pol.	High Flex Leder	7S1SH047651132B00
	8 m	UD	EA Amphenol 7-pol.	High Flex Leder	7S1SH087651132B00
ABITIG® 9F	4 m	UD	EA Amphenol 7-pol.	Standard	7S1FK047651132B00
	8 m	UD	EA Amphenol 7-pol.	Standard	7S1FK087651132B00
	4 m	UD	EA Amphenol 7-pol.	High Flex Leder	7S1FH047651132B00
	8 m	UD	EA Amphenol 7-pol.	High Flex Leder	7S1FH087651132B00
ABITIG® 17	4 m	UD	EA Amphenol 7-pol.	Standard	7S2SK047651132B00
	8 m	UD	EA Amphenol 7-pol.	Standard	7S2SK087651132B00
	4 m	UD	EA Amphenol 7-pol.	High Flex Leder	7S2SH047651132B00
	8 m	UD	EA Amphenol 7-pol.	High Flex Leder	7S2SH087651132B00
ABITIG® 17F	4 m	UD	EA Amphenol 7-pol.	Standard	7S2FK047651132B00
	8 m	UD	EA Amphenol 7-pol.	Standard	7S2FK087651132B00
	4 m	UD	EA Amphenol 7-pol.	High Flex Leder	7S2FH047651132B00
	8 m	UD	EA Amphenol 7-pol.	High Flex Leder	7S2FH087651132B00

Technische Änderungen vorbehalten • Verkaufspreise = unverbindliche Preisempfehlung - Angebot freibleibend • © Copyright

ABITIG® GRIP / ABITIG® GRIP Little-Brennerpreisliste

passend für WIG-Stromquellen des Fabrikates „kemppi“ Up/Down

Brennertyp	Länge	Schalterfunktion	maschinenseitiger Anschluss	Schlauchpaketausführung	Bestellnummer
ABITIG® 26	4 m	UD	EA Amphenol 7-pol.	Standard	7S3SK047651132B00
	8 m	UD	EA Amphenol 7-pol.	Standard	7S3SK087651132B00
	4 m	UD	EA Amphenol 7-pol.	High Flex Leder	7S3SH047651132B00
	8 m	UD	EA Amphenol 7-pol.	High Flex Leder	7S3SH087651132B00
ABITIG® 26F	4 m	UD	EA Amphenol 7-pol.	Standard	7S3FK047651132B00
	8 m	UD	EA Amphenol 7-pol.	Standard	7S3FK087651132B00
	4 m	UD	EA Amphenol 7-pol.	High Flex Leder	7S3FH047651132B00
	8 m	UD	EA Amphenol 7-pol.	High Flex Leder	7S3FH087651132B00
ABITIG® 24G	4 m	UD	EA Amphenol 7-pol.	Standard	7S8SK047651132B00
	8 m	UD	EA Amphenol 7-pol.	Standard	7S8SK087651132B00
	4 m	UD	EA Amphenol 7-pol.	High Flex Leder	7S8SH047651132B00
	8 m	UD	EA Amphenol 7-pol.	High Flex Leder	7S8SH087651132B00
ABITIG® 200	4 m	UD	EA Amphenol 7-pol.	Standard	7T4SK047651132B00
	8 m	UD	EA Amphenol 7-pol.	Standard	7T4SK087651132B00
	4 m	UD	EA Amphenol 7-pol.	High Flex Leder	7T4SH047651132B00
	8 m	UD	EA Amphenol 7-pol.	High Flex Leder	7T4SH087651132B00
ABITIG® 200F	4 m	UD	EA Amphenol 7-pol.	Standard	7T4FK047651132B00
	8 m	UD	EA Amphenol 7-pol.	Standard	7T4FK087651132B00
	4 m	UD	EA Amphenol 7-pol.	High Flex Leder	7T4FH047651132B00
	8 m	UD	EA Amphenol 7-pol.	High Flex Leder	7T4FH087651132B00
ABITIG® 150	4 m	UD	EA Amphenol 7-pol.	Standard	7T6SK047651132B00
	8 m	UD	EA Amphenol 7-pol.	Standard	7T6SK087651132B00
	4 m	UD	EA Amphenol 7-pol.	High Flex Leder	7T6SH047651132B00
	8 m	UD	EA Amphenol 7-pol.	High Flex Leder	7T6SH087651132B00
ABITIG® 150F	4 m	UD	EA Amphenol 7-pol.	Standard	7T6FK047651132B00
	8 m	UD	EA Amphenol 7-pol.	Standard	7T6FK087651132B00
	4 m	UD	EA Amphenol 7-pol.	High Flex Leder	7T6FH047651132B00
	8 m	UD	EA Amphenol 7-pol.	High Flex Leder	7T6FH087651132B00

ABITIG® GRIP / ABITIG® GRIP Little-Brennerpreisliste

passend für WIG-Stromquellen des Fabrikates „kemppi“

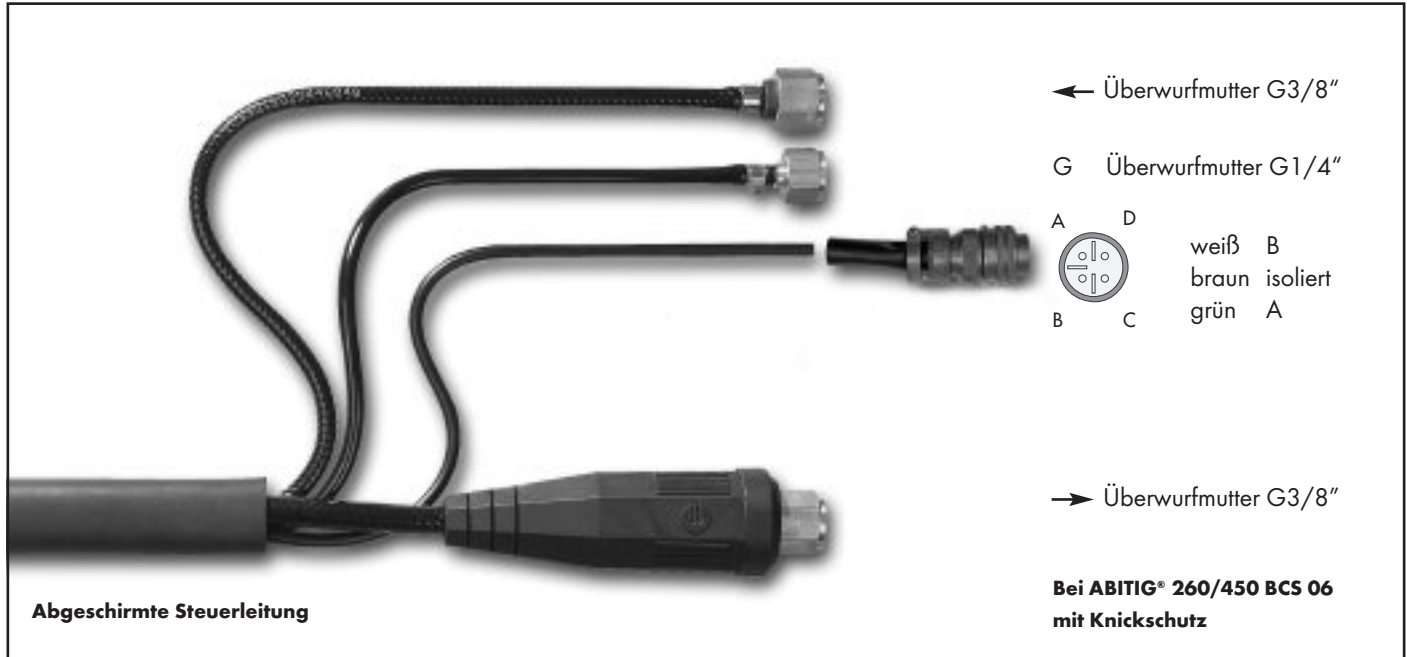

Brennertyp	Länge	Schalterfunktion	maschinenseitiger Anschluss	Schlauchpaketausführung	Bestellnummer
ABITIG® 18	4 m	ED	EA Amphenol 4-pol.	Standard	7S4SK047510610A15
	8 m	ED	EA Amphenol 4-pol.	Standard	7S4SK087510610A15
	4 m	ED	EA Amphenol 4-pol.	High Flex Leder	7S4SH047510610A15
	8 m	ED	EA Amphenol 4-pol.	High Flex Leder	7S4SH087510610A15
ABITIG® 18F	4 m	ED	EA Amphenol 4-pol.	Standard	7S4FK047510610A15
	8 m	ED	EA Amphenol 4-pol.	Standard	7S4FK087510610A15
	4 m	ED	EA Amphenol 4-pol.	High Flex Leder	7S4FH047510610A15
	8 m	ED	EA Amphenol 4-pol.	High Flex Leder	7S4FH087510610A15
ABITIG® 20	4 m	ED	EA Amphenol 4-pol.	Standard	7S5SK047510610A15
	8 m	ED	EA Amphenol 4-pol.	Standard	7S5SK087510610A15
	4 m	ED	EA Amphenol 4-pol.	High Flex Leder	7S5SH047510610A15
	8 m	ED	EA Amphenol 4-pol.	High Flex Leder	7S5SH087510610A15
ABITIG® 20 Little	4 m	ED	EA Amphenol 4-pol.	High Flex Leder	7L5SH047510610A15
	8 m	ED	EA Amphenol 4-pol.	High Flex Leder	7L5SH087510610A15
ABITIG® 20F	4 m	ED	EA Amphenol 4-pol.	Standard	7S5FK047510610A15
	8 m	ED	EA Amphenol 4-pol.	Standard	7S5FK087510610A15
	4 m	ED	EA Amphenol 4-pol.	High Flex Leder	7S5FH047510610A15
	8 m	ED	EA Amphenol 4-pol.	High Flex Leder	7S5FH087510610A15
ABITIG® 20F Little	4 m	ED	EA Amphenol 4-pol.	High Flex Leder	7L5FH047510610A15
	8 m	ED	EA Amphenol 4-pol.	High Flex Leder	7L5FH087510610A15

Technische Änderungen vorbehalten • Verkaufspreise = unverbindliche Preisempfehlung - Angebot freibleibend • © Copyright

ABITIG® GRIP / ABITIG® GRIP Little-Brennerpreisliste

passend für WIG-Stromquellen des Fabrikates „kemppi“

Brennertyp	Länge	Schalterfunktion	maschinenseitiger Anschluss	Schlauchpaketausführung	Bestellnummer
ABITIG® 12-1	4 m	ED	EA Amphenol 4-pol.	Standard	7S6SK047510610A15
	8 m	ED	EA Amphenol 4-pol.	Standard	7S6SK087510610A15
	4 m	ED	EA Amphenol 4-pol.	High Flex Leder	7S6SH047510610A15
	8 m	ED	EA Amphenol 4-pol.	High Flex Leder	7S6SH087510610A15
ABITIG® 18SC	4 m	ED	EA Amphenol 4-pol.	Standard	7S7SK047510610A15
	8 m	ED	EA Amphenol 4-pol.	Standard	7S7SK087510610A15
	4 m	ED	EA Amphenol 4-pol.	High Flex Leder	7S7SH047510610A15
	8 m	ED	EA Amphenol 4-pol.	High Flex Leder	7S7SH087510610A15
ABITIG® 24W	4 m	ED	EA Amphenol 4-pol.	Standard	7S9SK047510610A15
	8 m	ED	EA Amphenol 4-pol.	Standard	7S9SK087510610A15
	4 m	ED	EA Amphenol 4-pol.	High Flex Leder	7S9SH047510610A15
	8 m	ED	EA Amphenol 4-pol.	High Flex Leder	7S9SH087510610A15
ABITIG® 24W Little	4 m	ED	EA Amphenol 4-pol.	High Flex Leder	7L9SH047510610A15
	8 m	ED	EA Amphenol 4-pol.	High Flex Leder	7L9SH087510610A15
ABITIG® 450W	4 m	ED	EA Amphenol 4-pol.	Standard	7T5SK047510610A15
	8 m	ED	EA Amphenol 4-pol.	Standard	7T5SK087510610A15
	4 m	ED	EA Amphenol 4-pol.	High Flex Leder	7T5SH047510610A15
	8 m	ED	EA Amphenol 4-pol.	High Flex Leder	7T5SH087510610A15
ABITIG® 260W	4 m	ED	EA Amphenol 4-pol.	Standard	7T7SK047510610A15
	8 m	ED	EA Amphenol 4-pol.	Standard	7T7SK087510610A15
	4 m	ED	EA Amphenol 4-pol.	High Flex Leder	7T7SH047510610A15
	8 m	ED	EA Amphenol 4-pol.	High Flex Leder	7T7SH087510610A15
ABITIG® 260W Little	4 m	ED	EA Amphenol 4-pol.	High Flex Leder	7L7SH047510610A15
	8 m	ED	EA Amphenol 4-pol.	High Flex Leder	7L7SH087510610A15
ABITIG® 450W SC	4 m	ED	EA Amphenol 4-pol.	Standard	
	8 m	ED	EA Amphenol 4-pol.	Standard	
	4 m	ED	EA Amphenol 4-pol.	High Flex Leder	7T8SH047510610A15
	8 m	ED	EA Amphenol 4-pol.	High Flex Leder	7T8SH087510610A15

ABITIG® GRIP / ABITIG® GRIP Little-Brennerpreisliste

passend für WIG-Stromquellen des Fabrikates „kemppi“



Brennertyp	Länge	Schalterfunktion	maschinenseitiger Anschluss	Schlauchpaketausführung	Bestellnummer
ABITIG® 18	4 m	ED	ZA 9-pol.	Standard	7S4SK047510799B12
	8 m	ED	ZA 9-pol.	Standard	7S4SK087510799B12
	4 m	ED	ZA 9-pol.	High Flex Leder	7S4SH047510799B12
	8 m	ED	ZA 9-pol.	High Flex Leder	7S4SH087510799B12
ABITIG® 18F	4 m	ED	ZA 9-pol.	Standard	7S4FK047510799B12
	8 m	ED	ZA 9-pol.	Standard	7S4FK087510799B12
	4 m	ED	ZA 9-pol.	High Flex Leder	7S4FH047510799B12
	8 m	ED	ZA 9-pol.	High Flex Leder	7S4FH087510799B12
ABITIG® 20	4 m	ED	ZA 9-pol.	Standard	7S5SK047510799B12
	8 m	ED	ZA 9-pol.	Standard	7S5SK087510799B12
	4 m	ED	ZA 9-pol.	High Flex Leder	7S5SH047510799B12
	8 m	ED	ZA 9-pol.	High Flex Leder	7S5SH087510799B12
ABITIG® 20 Little	4 m	ED	ZA 9-pol.	High Flex Leder	7L5SH047510799B12
	8 m	ED	ZA 9-pol.	High Flex Leder	7L5SH087510799B12
ABITIG® 20F	4 m	ED	ZA 9-pol.	Standard	7S5FK047510799B12
	8 m	ED	ZA 9-pol.	Standard	7S5FK087510799B12
	4 m	ED	ZA 9-pol.	High Flex Leder	7S5FH047510799B12
	8 m	ED	ZA 9-pol.	High Flex Leder	7S5FH087510799B12
ABITIG® 20F Little	4 m	ED	ZA 9-pol.	High Flex Leder	7L5FH047510799B12
	8 m	ED	ZA 9-pol.	High Flex Leder	7L5FH087510799B12

Technische Änderungen vorbehalten • Verkaufspreise = unverbindliche Preisempfehlung - Angebot freibleibend • © Copyright

ABITIG® GRIP / ABITIG® GRIP Little-Brennerpreisliste

passend für WIG-Stromquellen des Fabrikates „kempfi“

Brennertyp	Länge	Schalterfunktion	maschinenseitiger Anschluss	Schlauchpaketausführung	Bestellnummer
ABITIG® 12-1	4 m	ED	ZA 9-pol.	Standard	7S6SK047510799B12
	8 m	ED	ZA 9-pol.	Standard	7S6SK087510799B12
	4 m	ED	ZA 9-pol.	High Flex Leder	7S6SH047510799B12
	8 m	ED	ZA 9-pol.	High Flex Leder	7S6SH087510799B12
ABITIG® 18SC	4 m	ED	ZA 9-pol.	Standard	7S7SK047510799B12
	8 m	ED	ZA 9-pol.	Standard	7S7SK087510799B12
	4 m	ED	ZA 9-pol.	High Flex Leder	7S7SH047510799B12
	8 m	ED	ZA 9-pol.	High Flex Leder	7S7SH087510799B12
ABITIG® 24W	4 m	ED	ZA 9-pol.	Standard	7S9SK047510799B12
	8 m	ED	ZA 9-pol.	Standard	7S9SK087510799B12
	4 m	ED	ZA 9-pol.	High Flex Leder	7S9SH047510799B12
	8 m	ED	ZA 9-pol.	High Flex Leder	7S9SH087510799B12
ABITIG® 24W Little	4 m	ED	ZA 9-pol.	High Flex Leder	7L9SH047510799B12
	8 m	ED	ZA 9-pol.	High Flex Leder	7L9SH087510799B12
ABITIG® 450W	4 m	ED	ZA 9-pol.	Standard	7T5SK047510799B12
	8 m	ED	ZA 9-pol.	Standard	7T5SK087510799B12
	4 m	ED	ZA 9-pol.	High Flex Leder	7T5SH047510799B12
	8 m	ED	ZA 9-pol.	High Flex Leder	7T5SH087510799B12
ABITIG® 260W	4 m	ED	ZA 9-pol.	Standard	7T7SK047510799B12
	8 m	ED	ZA 9-pol.	Standard	7T7SK087510799B12
	4 m	ED	ZA 9-pol.	High Flex Leder	7T7SH047510799B12
	8 m	ED	ZA 9-pol.	High Flex Leder	7T7SH087510799B12
ABITIG® 260W Little	4 m	ED	ZA 9-pol.	High Flex Leder	7L7SH047510799B12
	8 m	ED	ZA 9-pol.	High Flex Leder	7L7SH087510799B12
ABITIG® 450W SC	4 m	ED	ZA 9-pol.	Standard	
	8 m	ED	ZA 9-pol.	Standard	
	4 m	ED	ZA 9-pol.	High Flex Leder	7T8SH047510799B12
	8 m	ED	ZA 9-pol.	High Flex Leder	7T8SH087510799B12

ABITIG® GRIP / ABITIG® GRIP Little-Brennerpreisliste

passend für WIG-Stromquellen des Fabrikates „kemppi“

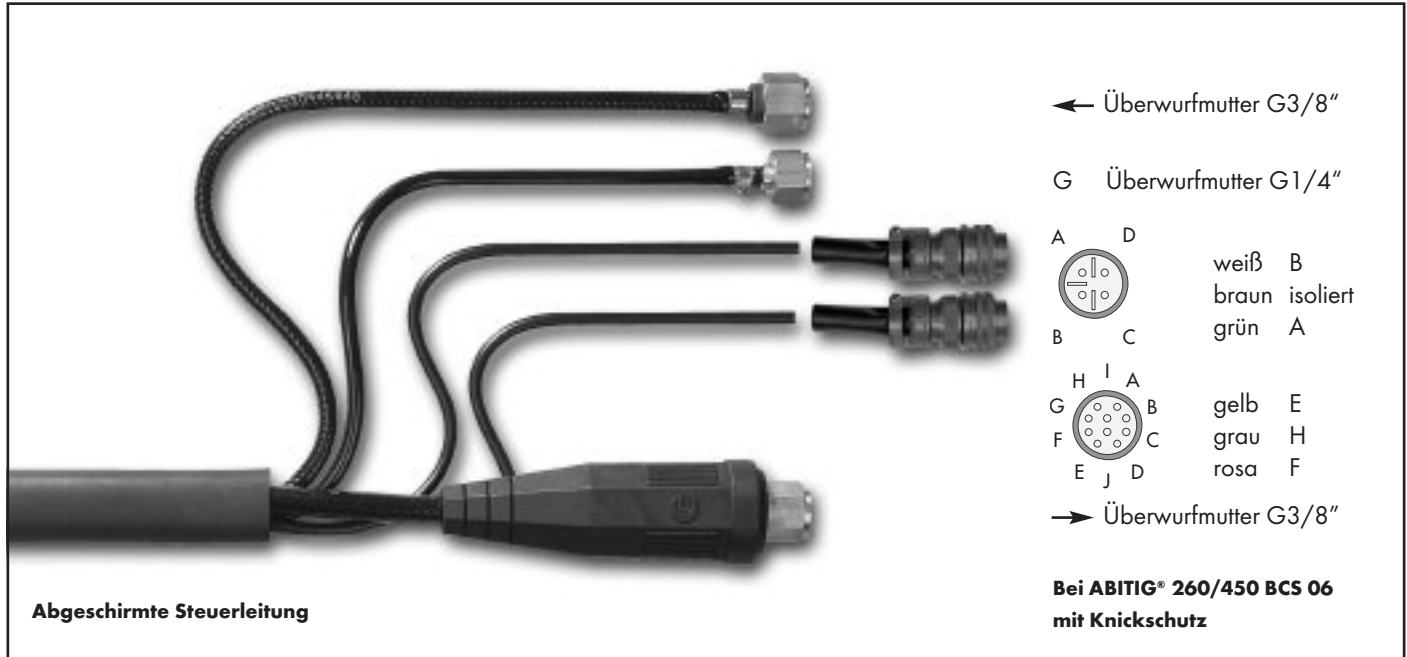

Brennertyp	Länge	Schalterfunktion	maschinenseitiger Anschluss	Schlauchpaketausführung	Bestellnummer
ABITIG® 18	4 m	EDP	EA Amphenol 4-pol. + Amphenol 10-pol.	Standard	7S4SK047540631A15
	8 m	EDP	EA Amphenol 4-pol. + Amphenol 10-pol.	Standard	7S4SK087540631A15
	4 m	EDP	EA Amphenol 4-pol. + Amphenol 10-pol.	High Flex Leder	7S4SH047540631A15
	8 m	EDP	EA Amphenol 4-pol. + Amphenol 10-pol.	High Flex Leder	7S4SH087540631A15
ABITIG® 18F	4 m	EDP	EA Amphenol 4-pol. + Amphenol 10-pol.	Standard	7S4FK047540631A15
	8 m	EDP	EA Amphenol 4-pol. + Amphenol 10-pol.	Standard	7S4FK087540631A15
	4 m	EDP	EA Amphenol 4-pol. + Amphenol 10-pol.	High Flex Leder	7S4FH047540631A15
	8 m	EDP	EA Amphenol 4-pol. + Amphenol 10-pol.	High Flex Leder	7S4FH087540631A15
ABITIG® 20	4 m	EDP	EA Amphenol 4-pol. + Amphenol 10-pol.	Standard	7S5SK047540631A15
	8 m	EDP	EA Amphenol 4-pol. + Amphenol 10-pol.	Standard	7S5SK087540631A15
	4 m	EDP	EA Amphenol 4-pol. + Amphenol 10-pol.	High Flex Leder	7S5SH047540631A15
	8 m	EDP	EA Amphenol 4-pol. + Amphenol 10-pol.	High Flex Leder	7S5SH087540631A15
ABITIG® 20F	4 m	EDP	EA Amphenol 4-pol. + Amphenol 10-pol.	Standard	7S5FK047540631A15
	8 m	EDP	EA Amphenol 4-pol. + Amphenol 10-pol.	Standard	7S5FK087540631A15
	4 m	EDP	EA Amphenol 4-pol. + Amphenol 10-pol.	High Flex Leder	7S5FH047540631A15
	8 m	EDP	EA Amphenol 4-pol. + Amphenol 10-pol.	High Flex Leder	7S5FH087540631A15

Technische Änderungen vorbehalten • Verkaufspreise = unverbindliche Preisempfehlung - Angebot freibleibend • © Copyright

ABITIG® GRIP / ABITIG® GRIP Little-Brennerpreisliste

passend für WIG-Stromquellen des Fabrikates „kempfi“

Brennertyp	Länge	Schalterfunktion	maschinenseitiger Anschluss	Schlauchpaketausführung	Bestellnummer
ABITIG® 12-1	4 m	EDP	EA Amphenol 4-pol. + Amphenol 10-pol.	Standard	7S6SK047540631A15
	8 m	EDP	EA Amphenol 4-pol. + Amphenol 10-pol.	Standard	7S6SK087540631A15
	4 m	EDP	EA Amphenol 4-pol. + Amphenol 10-pol.	High Flex Leder	7S6SH047540631A15
	8 m	EDP	EA Amphenol 4-pol. + Amphenol 10-pol.	High Flex Leder	7S6SH087540631A15
ABITIG® 18SC	4 m	EDP	EA Amphenol 4-pol. + Amphenol 10-pol.	Standard	7S7SK047540631A15
	8 m	EDP	EA Amphenol 4-pol. + Amphenol 10-pol.	Standard	7S7SK087540631A15
	4 m	EDP	EA Amphenol 4-pol. + Amphenol 10-pol.	High Flex Leder	7S7SH047540631A15
	8 m	EDP	EA Amphenol 4-pol. + Amphenol 10-pol.	High Flex Leder	7S7SH087540631A15
ABITIG® 24W	4 m	EDP	EA Amphenol 4-pol. + Amphenol 10-pol.	Standard	7S9SK047540631A15
	8 m	EDP	EA Amphenol 4-pol. + Amphenol 10-pol.	Standard	7S9SK087540631A15
	4 m	EDP	EA Amphenol 4-pol. + Amphenol 10-pol.	High Flex Leder	7S9SH047540631A15
	8 m	EDP	EA Amphenol 4-pol. + Amphenol 10-pol.	High Flex Leder	7S9SH087540631A15
ABITIG® 450W	4 m	EDP	EA Amphenol 4-pol. + Amphenol 10-pol.	Standard	7T5SK047540631A15
	8 m	EDP	EA Amphenol 4-pol. + Amphenol 10-pol.	Standard	7T5SK087540631A15
	4 m	EDP	EA Amphenol 4-pol. + Amphenol 10-pol.	High Flex Leder	7T5SH047540631A15
	8 m	EDP	EA Amphenol 4-pol. + Amphenol 10-pol.	High Flex Leder	7T5SH087540631A15
ABITIG® 260W	4 m	EDP	EA Amphenol 4-pol. + Amphenol 10-pol.	Standard	7T7SK047540631A15
	8 m	EDP	EA Amphenol 4-pol. + Amphenol 10-pol.	Standard	7T7SK087540631A15
	4 m	EDP	EA Amphenol 4-pol. + Amphenol 10-pol.	High Flex Leder	7T7SH047540631A15
	8 m	EDP	EA Amphenol 4-pol. + Amphenol 10-pol.	High Flex Leder	7T7SH087540631A15
ABITIG® 450W SC	4 m	EDP	EA Amphenol 4-pol. + Amphenol 10-pol.	Standard	
	8 m	EDP	EA Amphenol 4-pol. + Amphenol 10-pol.	Standard	
	4 m	EDP	EA Amphenol 4-pol. + Amphenol 10-pol.	High Flex Leder	7T8SH047540631A15
	8 m	EDP	EA Amphenol 4-pol. + Amphenol 10-pol.	High Flex Leder	7T8SH087540631A15

ABITIG® GRIP / ABITIG® GRIP Little-Brennerpreisliste

passend für WIG-Stromquellen des Fabrikates „kemppi“

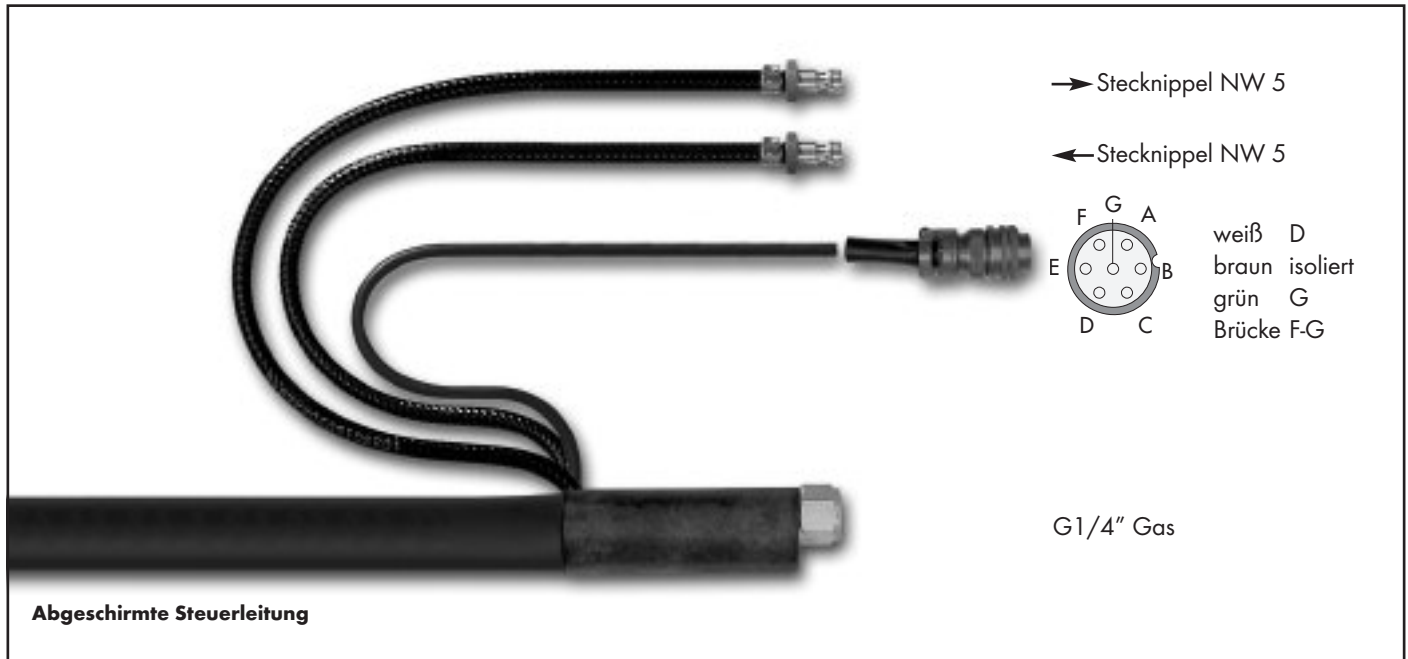

Brennertyp	Länge	Schalterfunktion	maschinenseitiger Anschluss	Schlauchpaketausführung	Bestellnummer
ABITIG® 18	4 m	ED	EA Amphenol 7-pol.	Standard	7S4SK047513546B12
	8 m	ED	EA Amphenol 7-pol.	Standard	7S4SK087513546B12
	4 m	ED	EA Amphenol 7-pol.	High Flex Leder	7S4SH047513546B12
	8 m	ED	EA Amphenol 7-pol.	High Flex Leder	7S4SH087513546B12
ABITIG® 18F	4 m	ED	EA Amphenol 7-pol.	Standard	7S4FK047513546B12
	8 m	ED	EA Amphenol 7-pol.	Standard	7S4FK087513546B12
	4 m	ED	EA Amphenol 7-pol.	High Flex Leder	7S4FH047513546B12
	8 m	ED	EA Amphenol 7-pol.	High Flex Leder	7S4FH087513546B12
ABITIG® 20	4 m	ED	EA Amphenol 7-pol.	Standard	7S5SK047513546B12
	8 m	ED	EA Amphenol 7-pol.	Standard	7S5SK087513546B12
	4 m	ED	EA Amphenol 7-pol.	High Flex Leder	7S5SH047513546B12
	8 m	ED	EA Amphenol 7-pol.	High Flex Leder	7S5SH087513546B12
ABITIG® 20F	4 m	ED	EA Amphenol 7-pol.	Standard	7S5FK047513546B12
	8 m	ED	EA Amphenol 7-pol.	Standard	7S5FK087513546B12
	4 m	ED	EA Amphenol 7-pol.	High Flex Leder	7S5FH047513546B12
	8 m	ED	EA Amphenol 7-pol.	High Flex Leder	7S5FH087513546B12
ABITIG® 20F Little	4 m	ED	EA Amphenol 7-pol.	High Flex Leder	7L5FH047513546B12
	8 m	ED	EA Amphenol 7-pol.	High Flex Leder	7L5FH087513546B12

Technische Änderungen vorbehalten • Verkaufspreise = unverbindliche Preisempfehlung - Angebot freibleibend • © Copyright

ABITIG® GRIP / ABITIG® GRIP Little-Brennerpreisliste

passend für WIG-Stromquellen des Fabrikates „kempfi“

Brennertyp	Länge	Schalterfunktion	maschinenseitiger Anschluss	Schlauchpaketausführung	Bestellnummer
ABITIG® 12-1	4 m	ED	EA Amphenol 7-pol.	Standard	7S6SK047513546B12
	8 m	ED	EA Amphenol 7-pol.	Standard	7S6SK087513546B12
	4 m	ED	EA Amphenol 7-pol.	High Flex Leder	7S6SH047513546B12
	8 m	ED	EA Amphenol 7-pol.	High Flex Leder	7S6SH087513546B12
ABITIG® 18SC	4 m	ED	EA Amphenol 7-pol.	Standard	7S7SK047513546B12
	8 m	ED	EA Amphenol 7-pol.	Standard	7S7SK087513546B12
	4 m	ED	EA Amphenol 7-pol.	High Flex Leder	7S7SH047513546B12
	8 m	ED	EA Amphenol 7-pol.	High Flex Leder	7S7SH087513546B12
ABITIG® 24W	4 m	ED	EA Amphenol 7-pol.	Standard	7S9SK047513546B12
	8 m	ED	EA Amphenol 7-pol.	Standard	7S9SK087513546B12
	4 m	ED	EA Amphenol 7-pol.	High Flex Leder	7S9SH047513546B12
	8 m	ED	EA Amphenol 7-pol.	High Flex Leder	7S9SH087513546B12
ABITIG® 24W Little	4 m	ED	EA Amphenol 7-pol.	High Flex Leder	7L9SH047513546B12
	8 m	ED	EA Amphenol 7-pol.	High Flex Leder	7L9SH087513546B12
ABITIG® 450W	4 m	ED	EA Amphenol 7-pol.	Standard	7T5SK047513546B12
	8 m	ED	EA Amphenol 7-pol.	Standard	7T5SK087513546B12
	4 m	ED	EA Amphenol 7-pol.	High Flex Leder	7T5SH047513546B12
	8 m	ED	EA Amphenol 7-pol.	High Flex Leder	7T5SH087513546B12
ABITIG® 260W	4 m	ED	EA Amphenol 7-pol.	Standard	7T7SK047513546B12
	8 m	ED	EA Amphenol 7-pol.	Standard	7T7SK087513546B12
	4 m	ED	EA Amphenol 7-pol.	High Flex Leder	7T7SH047513546B12
	8 m	ED	EA Amphenol 7-pol.	High Flex Leder	7T7SH087513546B12
ABITIG® 260W Little	4 m	ED	EA Amphenol 7-pol.	High Flex Leder	7L7SH047513546B12
	8 m	ED	EA Amphenol 7-pol.	High Flex Leder	7L7SH087513546B12
ABITIG® 450W SC	4 m	ED	EA Amphenol 7-pol.	Standard	
	8 m	ED	EA Amphenol 7-pol.	Standard	
	4 m	ED	EA Amphenol 7-pol.	High Flex Leder	7T8SH047513546B12
	8 m	ED	EA Amphenol 7-pol.	High Flex Leder	7T8SH087513546B12

ABITIG® GRIP / ABITIG® GRIP Little-Brennerpreisliste

passend für WIG-Stromquellen des Fabrikates „kemppi“



Brennertyp	Länge	Schalterfunktion	maschinenseitiger Anschluss	Schlauchpaketausführung	Bestellnummer
ABITIG® 18	4 m	EDP	EA Amphenol 7-pol.	Standard	7S4SK047543546D12
	8 m	EDP	EA Amphenol 7-pol.	Standard	7S4SK087543546D12
	4 m	EDP	EA Amphenol 7-pol.	High Flex Leder	7S4SH047543546D12
	8 m	EDP	EA Amphenol 7-pol.	High Flex Leder	7S4SH087543546D12
ABITIG® 18F	4 m	EDP	EA Amphenol 7-pol.	Standard	7S4FK047543546D12
	8 m	EDP	EA Amphenol 7-pol.	Standard	7S4FK087543546D12
	4 m	EDP	EA Amphenol 7-pol.	High Flex Leder	7S4FH047543546D12
	8 m	EDP	EA Amphenol 7-pol.	High Flex Leder	7S4FH087543546D12
ABITIG® 20	4 m	EDP	EA Amphenol 7-pol.	Standard	7S5SK047543546D12
	8 m	EDP	EA Amphenol 7-pol.	Standard	7S5SK087543546D12
	4 m	EDP	EA Amphenol 7-pol.	High Flex Leder	7S5SH047543546D12
	8 m	EDP	EA Amphenol 7-pol.	High Flex Leder	7S5SH087543546D12
ABITIG® 20F	4 m	EDP	EA Amphenol 7-pol.	Standard	7S5FK047543546D12
	8 m	EDP	EA Amphenol 7-pol.	Standard	7S5FK087543546D12
	4 m	EDP	EA Amphenol 7-pol.	High Flex Leder	7S5FH047543546D12
	8 m	EDP	EA Amphenol 7-pol.	High Flex Leder	7S5FH087543546D12

Technische Änderungen vorbehalten • Verkaufspreise = unverbindliche Preisempfehlung - Angebot freibleibend • © Copyright

ABITIG® GRIP / ABITIG® GRIP Little-Brennerpreisliste

passend für WIG-Stromquellen des Fabrikates „kemppi“

Brennertyp	Länge	Schalterfunktion	maschinenseitiger Anschluss	Schlauchpaketausführung	Bestellnummer
ABITIG® 12-1	4 m	EDP	EA Amphenol 7-pol.	Standard	7S6SK047543546D12
	8 m	EDP	EA Amphenol 7-pol.	Standard	7S6SK087543546D12
	4 m	EDP	EA Amphenol 7-pol.	High Flex Leder	7S6SH047543546D12
	8 m	EDP	EA Amphenol 7-pol.	High Flex Leder	7S6SH087543546D12
ABITIG® 18SC	4 m	EDP	EA Amphenol 7-pol.	Standard	7S7SK047543546D12
	8 m	EDP	EA Amphenol 7-pol.	Standard	7S7SK087543546D12
	4 m	EDP	EA Amphenol 7-pol.	High Flex Leder	7S7SH047543546D12
	8 m	EDP	EA Amphenol 7-pol.	High Flex Leder	7S7SH087543546D12
ABITIG® 24W	4 m	EDP	EA Amphenol 7-pol.	Standard	7S9SK047543546D12
	8 m	EDP	EA Amphenol 7-pol.	Standard	7S9SK087543546D12
	4 m	EDP	EA Amphenol 7-pol.	High Flex Leder	7S9SH047543546D12
	8 m	EDP	EA Amphenol 7-pol.	High Flex Leder	7S9SH087543546D12
ABITIG® 450W	4 m	EDP	EA Amphenol 7-pol.	Standard	7T5SK047543546D12
	8 m	EDP	EA Amphenol 7-pol.	Standard	7T5SK087543546D12
	4 m	EDP	EA Amphenol 7-pol.	High Flex Leder	7T5SH047543546D12
	8 m	EDP	EA Amphenol 7-pol.	High Flex Leder	7T5SH087543546D12
ABITIG® 260W	4 m	EDP	EA Amphenol 7-pol.	Standard	7T7SK047543546D12
	8 m	EDP	EA Amphenol 7-pol.	Standard	7T7SK087543546D12
	4 m	EDP	EA Amphenol 7-pol.	High Flex Leder	7T7SH047543546D12
	8 m	EDP	EA Amphenol 7-pol.	High Flex Leder	7T7SH087543546D12
ABITIG® 450W SC	4 m	EDP	EA Amphenol 7-pol.	Standard	
	8 m	EDP	EA Amphenol 7-pol.	Standard	
	4 m	EDP	EA Amphenol 7-pol.	High Flex Leder	7T8SH047543546D12
	8 m	EDP	EA Amphenol 7-pol.	High Flex Leder	7T8SH087543546D12

ABITIG® GRIP / ABITIG® GRIP Little-Brennerpreisliste

passend für WIG-Stromquellen des Fabrikates „kemppi“ Up/Down

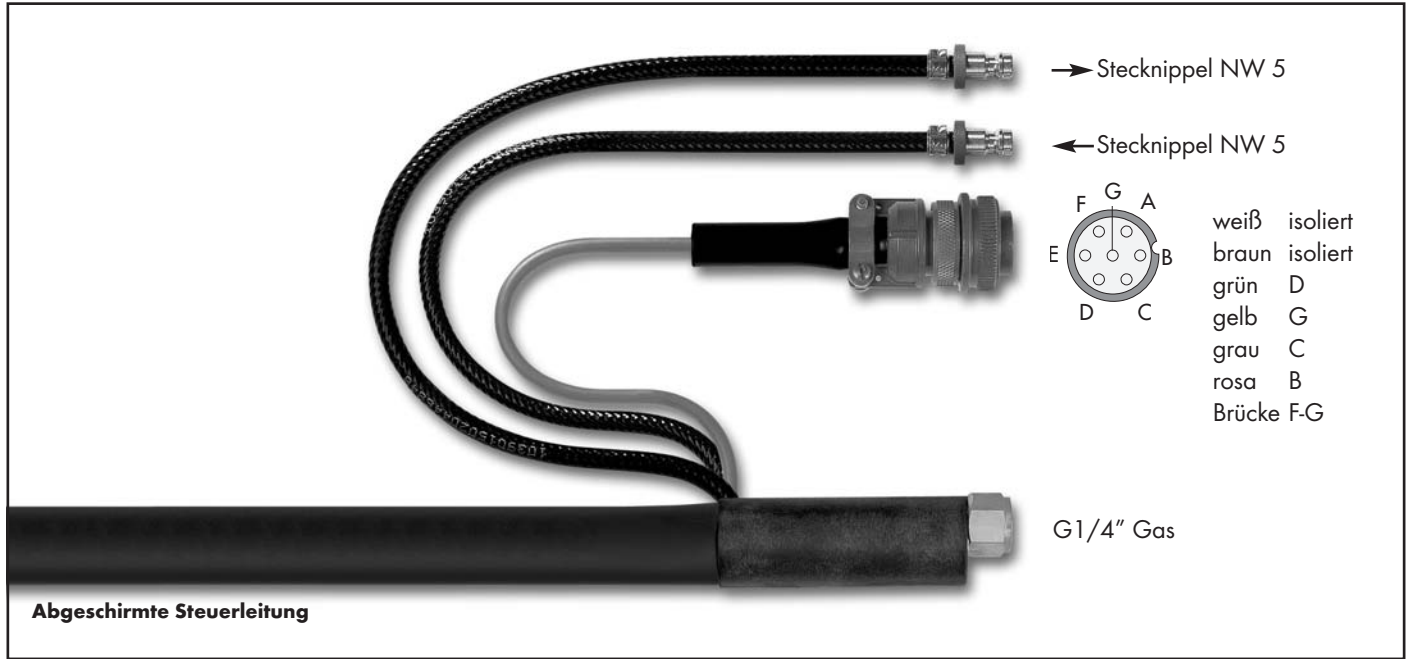

Brennertyp	Länge	Schalterfunktion	maschinenseitiger Anschluss	Schlauchpaketausführung	Bestellnummer
ABITIG® 18	4 m	UD	EA Amphenol 7-pol.	Standard	7S4SK047653532C12
	8 m	UD	EA Amphenol 7-pol.	Standard	7S4SK087653532C12
	4 m	UD	EA Amphenol 7-pol.	High Flex Leder	7S4SH047653532C12
	8 m	UD	EA Amphenol 7-pol.	High Flex Leder	7S4SH087653532C12
ABITIG® 18F	4 m	UD	EA Amphenol 7-pol.	Standard	7S4FK047653532C12
	8 m	UD	EA Amphenol 7-pol.	Standard	7S4FK087653532C12
	4 m	UD	EA Amphenol 7-pol.	High Flex Leder	7S4FH047653532C12
	8 m	UD	EA Amphenol 7-pol.	High Flex Leder	7S4FH087653532C12
ABITIG® 20	4 m	UD	EA Amphenol 7-pol.	Standard	7S5SK047653532C12
	8 m	UD	EA Amphenol 7-pol.	Standard	7S5SK087653532C12
	4 m	UD	EA Amphenol 7-pol.	High Flex Leder	7S5SH047653532C12
	8 m	UD	EA Amphenol 7-pol.	High Flex Leder	7S5SH087653532C12
ABITIG® 20 Little	4 m	UD	EA Amphenol 7-pol.	High Flex Leder	7L5SH047653532C12
	8 m	UD	EA Amphenol 7-pol.	High Flex Leder	7L5SH087653532C12
ABITIG® 20F	4 m	UD	EA Amphenol 7-pol.	Standard	7S5FK047653532C12
	8 m	UD	EA Amphenol 7-pol.	Standard	7S5FK087653532C12
	4 m	UD	EA Amphenol 7-pol.	High Flex Leder	7S5FH047653532C12
	8 m	UD	EA Amphenol 7-pol.	High Flex Leder	7S5FH087653532C12
ABITIG® 20F Little	4 m	UD	EA Amphenol 7-pol.	High Flex Leder	7L5FH047653532C12
	8 m	UD	EA Amphenol 7-pol.	High Flex Leder	7L5FH087653532C12

Technische Änderungen vorbehalten • Verkaufspreise = unverbindliche Preisempfehlung - Angebot freibleibend • © Copyright

ABITIG® GRIP / ABITIG® GRIP Little-Brennerpreisliste

passend für WIG-Stromquellen des Fabrikates „kemppi“ Up/Down

Brennertyp	Länge	Schalterfunktion	maschinenseitiger Anschluss	Schlauchpaketausführung	Bestellnummer
ABITIG® 12-1	4 m	UD	EA Amphenol 7-pol.	Standard	7S6SK047653532C12
	8 m	UD	EA Amphenol 7-pol.	Standard	7S6SK087653532C12
	4 m	UD	EA Amphenol 7-pol.	High Flex Leder	7S6SH047653532C12
	8 m	UD	EA Amphenol 7-pol.	High Flex Leder	7S6SH087653532C12
ABITIG® 18SC	4 m	UD	EA Amphenol 7-pol.	Standard	7S7SK047653532C12
	8 m	UD	EA Amphenol 7-pol.	Standard	7S7SK087653532C12
	4 m	UD	EA Amphenol 7-pol.	High Flex Leder	7S7SH047653532C12
	8 m	UD	EA Amphenol 7-pol.	High Flex Leder	7S7SH087653532C12
ABITIG® 24W	4 m	UD	EA Amphenol 7-pol.	Standard	7S9SK047653532C12
	8 m	UD	EA Amphenol 7-pol.	Standard	7S9SK087653532C12
	4 m	UD	EA Amphenol 7-pol.	High Flex Leder	7S9SH047653532C12
	8 m	UD	EA Amphenol 7-pol.	High Flex Leder	7S9SH087653532C12
ABITIG® 24W Little	4 m	UD	EA Amphenol 7-pol.	High Flex Leder	7L9SH047653532C12
	8 m	UD	EA Amphenol 7-pol.	High Flex Leder	7L9SH087653532C12
ABITIG® 450W	4 m	UD	EA Amphenol 7-pol.	Standard	7T5SK047653532C12
	8 m	UD	EA Amphenol 7-pol.	Standard	7T5SK087653532C12
	4 m	UD	EA Amphenol 7-pol.	High Flex Leder	7T5SH047653532C12
	8 m	UD	EA Amphenol 7-pol.	High Flex Leder	7T5SH087653532C12
ABITIG® 260W	4 m	UD	EA Amphenol 7-pol.	Standard	7T7SK047653532C12
	8 m	UD	EA Amphenol 7-pol.	Standard	7T7SK087653532C12
	4 m	UD	EA Amphenol 7-pol.	High Flex Leder	7T7SH047653532C12
	8 m	UD	EA Amphenol 7-pol.	High Flex Leder	7T7SH087653532C12
ABITIG® 260W Little	4 m	UD	EA Amphenol 7-pol.	High Flex Leder	7L7SH047653532C12
	8 m	UD	EA Amphenol 7-pol.	High Flex Leder	7L7SH087653532C12
ABITIG® 450W SC	4 m	UD	EA Amphenol 7-pol.	Standard	
	8 m	UD	EA Amphenol 7-pol.	Standard	
	4 m	UD	EA Amphenol 7-pol.	High Flex Leder	7T8SH047653532C12
	8 m	UD	EA Amphenol 7-pol.	High Flex Leder	7T8SH087653532C12

ABITIG® GRIP / ABITIG® GRIP Little-Brennerpreisliste

passend für WIG-Stromquellen des Fabrikates „kjellberg“



Brennertyp	Länge	Schalterfunktion	maschinenseitiger Anschluss	Schlauchpaketausführung	Bestellnummer	Preis (€)
ABITIG® 9	4 m	ED	BSB 10-25 Tuchel 5-pol.	Standard	7S1SK043512226A06	102.93
	8 m	ED	BSB 10-25 Tuchel 5-pol.	Standard	7S1SK083512226A06	127.07
	4 m	ED	BSB 10-25 Tuchel 5-pol.	High Flex Leder	7S1SH043512226A06	139.15
	8 m	ED	BSB 10-25 Tuchel 5-pol.	High Flex Leder	7S1SH083512226A06	172.74
ABITIG® 9 Little	4 m	ED	BSB 10-25 Tuchel 5-pol.	High Flex Leder	7L1SH043512226A06	139.15
	8 m	ED	BSB 10-25 Tuchel 5-pol.	High Flex Leder	7L1SH083512226A06	172.74
ABITIG® 9F	4 m	ED	BSB 10-25 Tuchel 5-pol.	Standard	7S1FK043512226A06	108.72
	8 m	ED	BSB 10-25 Tuchel 5-pol.	Standard	7S1FK083512226A06	132.86
	4 m	ED	BSB 10-25 Tuchel 5-pol.	High Flex Leder	7S1FH043512226A06	144.94
	8 m	ED	BSB 10-25 Tuchel 5-pol.	High Flex Leder	7S1FH083512226A06	178.53
ABITIG® 9F Little	4 m	ED	BSB 10-25 Tuchel 5-pol.	High Flex Leder	7L1FH043512226A06	144.94
	8 m	ED	BSB 10-25 Tuchel 5-pol.	High Flex Leder	7L1FH083512226A06	178.53
ABITIG® 17	4 m	ED	BSB 10-25 Tuchel 5-pol.	Standard	7S2SK043512226A06	106.18
	8 m	ED	BSB 10-25 Tuchel 5-pol.	Standard	7S2SK083512226A06	130.32
	4 m	ED	BSB 10-25 Tuchel 5-pol.	High Flex Leder	7S2SH043512226A06	147.63
	8 m	ED	BSB 10-25 Tuchel 5-pol.	High Flex Leder	7S2SH083512226A06	188.10
ABITIG® 17 Little	4 m	ED	BSB 10-25 Tuchel 5-pol.	High Flex Leder	7L2SH043512226A06	147.63
	8 m	ED	BSB 10-25 Tuchel 5-pol.	High Flex Leder	7L2SH083512226A06	188.10
ABITIG® 17F	4 m	ED	BSB 10-25 Tuchel 5-pol.	Standard	7S2FK043512226A06	109.61
	8 m	ED	BSB 10-25 Tuchel 5-pol.	Standard	7S2FK083512226A06	133.75
	4 m	ED	BSB 10-25 Tuchel 5-pol.	High Flex Leder	7S2FH043512226A06	151.06
	8 m	ED	BSB 10-25 Tuchel 5-pol.	High Flex Leder	7S2FH083512226A06	191.53
ABITIG® 17F Little	4 m	ED	BSB 10-25 Tuchel 5-pol.	High Flex Leder	7L2FH043512226A06	151.06
	8 m	ED	BSB 10-25 Tuchel 5-pol.	High Flex Leder	7L2FH083512226A06	191.53

Technische Änderungen vorbehalten • Verkaufspreise = unverbindliche Preisempfehlung - Angebot freibleibend • © Copyright

ABITIG® GRIP / ABITIG® GRIP Little-Brennerpreisliste

passend für WIG-Stromquellen des Fabrikates „kjellberg“

Brennertyp	Länge	Schalterfunktion	maschinenseitiger Anschluss	Schlauchpaketausführung	Bestellnummer	Preis (€)
ABITIG® 26						
ABITIG® 26F						
ABITIG® 24G	4 m	ED	BSB 10-25 Tuchel 5-pol.	Standard	7S8SK043512226A06	115.37
	8 m	ED	BSB 10-25 Tuchel 5-pol.	Standard	7S8SK083512226A06	139.51
	4 m	ED	BSB 10-25 Tuchel 5-pol.	High Flex Leder	7S8SH043512226A06	156.82
	8 m	ED	BSB 10-25 Tuchel 5-pol.	High Flex Leder	7S8SH083512226A06	197.29
ABITIG® 24G Little	4 m	ED	BSB 10-25 Tuchel 5-pol.	High Flex Leder	7L8SH043512226A06	156.82
	8 m	ED	BSB 10-25 Tuchel 5-pol.	High Flex Leder	7L8SH083512226A06	197.29
ABITIG® 200						
ABITIG® 200F						
ABITIG® 150	4 m	ED	BSB 10-25 Tuchel 5-pol.	Standard	7T6SK043512226A06	140.58
	8 m	ED	BSB 10-25 Tuchel 5-pol.	Standard	7T6SK083512226A06	170.46
	4 m	ED	BSB 10-25 Tuchel 5-pol.	High Flex Leder	7T6SH043512226A06	192.69
	8 m	ED	BSB 10-25 Tuchel 5-pol.	High Flex Leder	7T6SH083512226A06	243.28
ABITIG® 150 Little	4 m	ED	BSB 10-25 Tuchel 5-pol.	High Flex Leder	7L6SH043512226A06	192.69
	8 m	ED	BSB 10-25 Tuchel 5-pol.	High Flex Leder	7L6SH083512226A06	243.28
ABITIG® 150F	4 m	ED	BSB 10-25 Tuchel 5-pol.	Standard	7T6FK043512226A06	140.77
	8 m	ED	BSB 10-25 Tuchel 5-pol.	Standard	7T6FK083512226A06	170.65
	4 m	ED	BSB 10-25 Tuchel 5-pol.	High Flex Leder	7T6FH043512226A06	192.88
	8 m	ED	BSB 10-25 Tuchel 5-pol.	High Flex Leder	7T6FH083512226A06	243.47
ABITIG® 150F Little	4 m	ED	BSB 10-25 Tuchel 5-pol.	High Flex Leder	7L6FH043512226A06	192.88
	8 m	ED	BSB 10-25 Tuchel 5-pol.	High Flex Leder	7L6FH083512226A06	243.47

ABITIG® GRIP / ABITIG® GRIP Little-Brennerpreisliste

passend für WIG-Stromquellen des Fabrikates „kjellberg“



Brennertyp	Länge	Schalterfunktion	maschinenseitiger Anschluss	Schlauchpaketausführung	Bestellnummer	Preis (€)
ABITIG® 9	4 m	ED	BSB 35-50 Tuchel 5-pol.	Standard	7S1SK043510026A06	103.22
	8 m	ED	BSB 35-50 Tuchel 5-pol.	Standard	7S1SK083510026A06	127.36
	4 m	ED	BSB 35-50 Tuchel 5-pol.	High Flex Leder	7S1SH043510026A06	139.44
	8 m	ED	BSB 35-50 Tuchel 5-pol.	High Flex Leder	7S1SH083510026A06	173.03
ABITIG® 9 Little	4 m	ED	BSB 35-50 Tuchel 5-pol.	High Flex Leder	7L1SH043510026A06	139.44
	8 m	ED	BSB 35-50 Tuchel 5-pol.	High Flex Leder	7L1SH083510026A06	173.03
ABITIG® 9F	4 m	ED	BSB 35-50 Tuchel 5-pol.	Standard	7S1FK043510026A06	109.01
	8 m	ED	BSB 35-50 Tuchel 5-pol.	Standard	7S1FK083510026A06	133.15
	4 m	ED	BSB 35-50 Tuchel 5-pol.	High Flex Leder	7S1FH043510026A06	145.23
	8 m	ED	BSB 35-50 Tuchel 5-pol.	High Flex Leder	7S1FH083510026A06	178.82
ABITIG® 9F Little	4 m	ED	BSB 35-50 Tuchel 5-pol.	High Flex Leder	7L1FH043510026A06	145.23
	8 m	ED	BSB 35-50 Tuchel 5-pol.	High Flex Leder	7L1FH083510026A06	178.82
ABITIG® 17	4 m	ED	BSB 35-50 Tuchel 5-pol.	Standard	7S2SK043510026A06	106.47
	8 m	ED	BSB 35-50 Tuchel 5-pol.	Standard	7S2SK083510026A06	130.61
	4 m	ED	BSB 35-50 Tuchel 5-pol.	High Flex Leder	7S2SH043510026A06	147.92
	8 m	ED	BSB 35-50 Tuchel 5-pol.	High Flex Leder	7S2SH083510026A06	188.39
ABITIG® 17 Little	4 m	ED	BSB 35-50 Tuchel 5-pol.	High Flex Leder	7L2SH043510026A06	147.92
	8 m	ED	BSB 35-50 Tuchel 5-pol.	High Flex Leder	7L2SH083510026A06	188.39
ABITIG® 17F	4 m	ED	BSB 35-50 Tuchel 5-pol.	Standard	7S2FK043510026A06	109.90
	8 m	ED	BSB 35-50 Tuchel 5-pol.	Standard	7S2FK083510026A06	134.04
	4 m	ED	BSB 35-50 Tuchel 5-pol.	High Flex Leder	7S2FH043510026A06	151.35
	8 m	ED	BSB 35-50 Tuchel 5-pol.	High Flex Leder	7S2FH083510026A06	191.82
ABITIG® 17F Little	4 m	ED	BSB 35-50 Tuchel 5-pol.	High Flex Leder	7L2FH043510026A06	151.35
	8 m	ED	BSB 35-50 Tuchel 5-pol.	High Flex Leder	7L2FH083510026A06	191.82

Technische Änderungen vorbehalten • Verkaufspreise = unverbindliche Preisempfehlung - Angebot freibleibend • © Copyright

ABITIG® GRIP / ABITIG® GRIP Little-Brennerpreisliste

passend für WIG-Stromquellen des Fabrikates „kjellberg“

Brennertyp	Länge	Schalterfunktion	maschinenseitiger Anschluss	Schlauchpaketausführung	Bestellnummer	Preis (€)
ABITIG® 26	4 m	ED	BSB 35-50 Tuchel 5-pol.	Standard	7S3SK043510026A06	113.48
	8 m	ED	BSB 35-50 Tuchel 5-pol.	Standard	7S3SK083510026A06	144.06
	4 m	ED	BSB 35-50 Tuchel 5-pol.	High Flex Leder	7S3SH043510026A06	152.13
	8 m	ED	BSB 35-50 Tuchel 5-pol.	High Flex Leder	7S3SH083510026A06	197.32
ABITIG® 26F	4 m	ED	BSB 35-50 Tuchel 5-pol.	Standard	7S3FK043510026A06	119.88
	8 m	ED	BSB 35-50 Tuchel 5-pol.	Standard	7S3FK083510026A06	150.46
	4 m	ED	BSB 35-50 Tuchel 5-pol.	High Flex Leder	7S3FH043510026A06	158.53
	8 m	ED	BSB 35-50 Tuchel 5-pol.	High Flex Leder	7S3FH083510026A06	203.72
ABITIG® 24G	4 m	ED	BSB 35-50 Tuchel 5-pol.	Standard	7S8SK043510026A06	115.66
	8 m	ED	BSB 35-50 Tuchel 5-pol.	Standard	7S8SK083510026A06	139.80
	4 m	ED	BSB 35-50 Tuchel 5-pol.	High Flex Leder	7S8SH043510026A06	157.11
	8 m	ED	BSB 35-50 Tuchel 5-pol.	High Flex Leder	7S8SH083510026A06	197.58
ABITIG® 24G Little	4 m	ED	BSB 35-50 Tuchel 5-pol.	High Flex Leder	7L8SH043510026A06	157.11
	8 m	ED	BSB 35-50 Tuchel 5-pol.	High Flex Leder	7L8SH083510026A06	197.58
ABITIG® 200	4 m	ED	BSB 35-50 Tuchel 5-pol.	Standard	7T4SK043510026A06	148.19
	8 m	ED	BSB 35-50 Tuchel 5-pol.	Standard	7T4SK083510026A06	187.19
	4 m	ED	BSB 35-50 Tuchel 5-pol.	High Flex Leder	7T4SH043510026A06	198.16
	8 m	ED	BSB 35-50 Tuchel 5-pol.	High Flex Leder	7T4SH083510026A06	256.27
ABITIG® 200F	4 m	ED	BSB 35-50 Tuchel 5-pol.	Standard	7T4FK043510026A06	157.35
	8 m	ED	BSB 35-50 Tuchel 5-pol.	Standard	7T4FK083510026A06	196.35
	4 m	ED	BSB 35-50 Tuchel 5-pol.	High Flex Leder	7T4FH043510026A06	207.32
	8 m	ED	BSB 35-50 Tuchel 5-pol.	High Flex Leder	7T4FH083510026A06	265.43
ABITIG® 150	4 m	ED	BSB 35-50 Tuchel 5-pol.	Standard	7T6SK043510026A06	140.95
	8 m	ED	BSB 35-50 Tuchel 5-pol.	Standard	7T6SK083510026A06	170.83
	4 m	ED	BSB 35-50 Tuchel 5-pol.	High Flex Leder	7T6SH043510026A06	193.06
	8 m	ED	BSB 35-50 Tuchel 5-pol.	High Flex Leder	7T6SH083510026A06	243.65
ABITIG® 150 Little	4 m	ED	BSB 35-50 Tuchel 5-pol.	High Flex Leder	7L6SH043510026A06	193.06
	8 m	ED	BSB 35-50 Tuchel 5-pol.	High Flex Leder	7L6SH083510026A06	243.65
ABITIG® 150F	4 m	ED	BSB 35-50 Tuchel 5-pol.	Standard	7T6FK043510026A06	141.14
	8 m	ED	BSB 35-50 Tuchel 5-pol.	Standard	7T6FK083510026A06	171.02
	4 m	ED	BSB 35-50 Tuchel 5-pol.	High Flex Leder	7T6FH043510026A06	193.25
	8 m	ED	BSB 35-50 Tuchel 5-pol.	High Flex Leder	7T6FH083510026A06	243.84
ABITIG® 150F Little	4 m	ED	BSB 35-50 Tuchel 5-pol.	High Flex Leder	7L6FH043510026A06	193.25
	8 m	ED	BSB 35-50 Tuchel 5-pol.	High Flex Leder	7L6FH083510026A06	243.84

ABITIG® GRIP / ABITIG® GRIP Little-Brennerpreisliste

passend für WIG-Stromquellen des Fabrikates „kjellberg“



Brennertyp	Länge	Schalterfunktion	maschinenseitiger Anschluss	Schlauchpaketausführung	Bestellnummer	Preis (€)
ABITIG® 9	4 m	ED	BSB 10-25 Tuchel 3-pol.	Standard	7S1SK043512213B06	100.81
	8 m	ED	BSB 10-25 Tuchel 3-pol.	Standard	7S1SK083512213B06	124.95
	4 m	ED	BSB 10-25 Tuchel 3-pol.	High Flex Leder	7S1SH043512213B06	137.03
	8 m	ED	BSB 10-25 Tuchel 3-pol.	High Flex Leder	7S1SH083512213B06	170.62
ABITIG® 9 Little	4 m	ED	BSB 10-25 Tuchel 3-pol.	High Flex Leder	7L1SH043512213B06	137.03
	8 m	ED	BSB 10-25 Tuchel 3-pol.	High Flex Leder	7L1SH083512213B06	170.62
ABITIG® 9F	4 m	ED	BSB 10-25 Tuchel 3-pol.	Standard	7S1FK043512213B06	106.60
	8 m	ED	BSB 10-25 Tuchel 3-pol.	Standard	7S1FK083512213B06	130.74
	4 m	ED	BSB 10-25 Tuchel 3-pol.	High Flex Leder	7S1FH043512213B06	142.82
	8 m	ED	BSB 10-25 Tuchel 3-pol.	High Flex Leder	7S1FH083512213B06	176.41
ABITIG® 9F Little	4 m	ED	BSB 10-25 Tuchel 3-pol.	High Flex Leder	7L1FH043512213B06	142.82
	8 m	ED	BSB 10-25 Tuchel 3-pol.	High Flex Leder	7L1FH083512213B06	176.41
ABITIG® 17	4 m	ED	BSB 10-25 Tuchel 3-pol.	Standard	7S2SK043512213B06	104.06
	8 m	ED	BSB 10-25 Tuchel 3-pol.	Standard	7S2SK083512213B06	128.20
	4 m	ED	BSB 10-25 Tuchel 3-pol.	High Flex Leder	7S2SH043512213B06	145.51
	8 m	ED	BSB 10-25 Tuchel 3-pol.	High Flex Leder	7S2SH083512213B06	185.98
ABITIG® 17 Little	4 m	ED	BSB 10-25 Tuchel 3-pol.	High Flex Leder	7L2SH043512213B06	145.51
	8 m	ED	BSB 10-25 Tuchel 3-pol.	High Flex Leder	7L2SH083512213B06	185.98
ABITIG® 17F	4 m	ED	BSB 10-25 Tuchel 3-pol.	Standard	7S2FK043512213B06	107.49
	8 m	ED	BSB 10-25 Tuchel 3-pol.	Standard	7S2FK083512213B06	131.63
	4 m	ED	BSB 10-25 Tuchel 3-pol.	High Flex Leder	7S2FH043512213B06	148.94
	8 m	ED	BSB 10-25 Tuchel 3-pol.	High Flex Leder	7S2FH083512213B06	189.41
ABITIG® 17F Little	4 m	ED	BSB 10-25 Tuchel 3-pol.	High Flex Leder	7L2FH043512213B06	148.94
	8 m	ED	BSB 10-25 Tuchel 3-pol.	High Flex Leder	7L2FH083512213B06	189.41

Technische Änderungen vorbehalten • Verkaufspreise = unverbindliche Preisempfehlung - Angebot freibleibend • © Copyright

ABITIG® GRIP / ABITIG® GRIP Little-Brennerpreisliste

passend für WIG-Stromquellen des Fabrikates „kjellberg“

Brennertyp	Länge	Schalterfunktion	maschinenseitiger Anschluss	Schlauchpaketausführung	Bestellnummer	Preis (€)
ABITIG® 26						
ABITIG® 26F						
ABITIG® 24G	4 m	ED	BSB 10-25 Tuchel 3-pol.	Standard	7S8SK043512213B06	113.25
	8 m	ED	BSB 10-25 Tuchel 3-pol.	Standard	7S8SK083512213B06	137.39
	4 m	ED	BSB 10-25 Tuchel 3-pol.	High Flex Leder	7S8SH043512213B06	154.70
	8 m	ED	BSB 10-25 Tuchel 3-pol.	High Flex Leder	7S8SH083512213B06	195.17
ABITIG® 24G Little	4 m	ED	BSB 10-25 Tuchel 3-pol.	High Flex Leder	7L8SH043512213B06	154.70
	8 m	ED	BSB 10-25 Tuchel 3-pol.	High Flex Leder	7L8SH083512213B06	195.17
ABITIG® 200						
ABITIG® 200F						
ABITIG® 150	4 m	ED	BSB 10-25 Tuchel 3-pol.	Standard	7T6SK043512213B06	137.92
	8 m	ED	BSB 10-25 Tuchel 3-pol.	Standard	7T6SK083512213B06	167.80
	4 m	ED	BSB 10-25 Tuchel 3-pol.	High Flex Leder	7T6SH043512213B06	190.03
	8 m	ED	BSB 10-25 Tuchel 3-pol.	High Flex Leder	7T6SH083512213B06	240.62
ABITIG® 150 Little	4 m	ED	BSB 10-25 Tuchel 3-pol.	High Flex Leder	7L6SH043512213B06	190.03
	8 m	ED	BSB 10-25 Tuchel 3-pol.	High Flex Leder	7L6SH083512213B06	240.62
ABITIG® 150F	4 m	ED	BSB 10-25 Tuchel 3-pol.	Standard	7T6FK043512213B06	138.11
	8 m	ED	BSB 10-25 Tuchel 3-pol.	Standard	7T6FK083512213B06	167.99
	4 m	ED	BSB 10-25 Tuchel 3-pol.	High Flex Leder	7T6FH043512213B06	190.22
	8 m	ED	BSB 10-25 Tuchel 3-pol.	High Flex Leder	7T6FH083512213B06	240.81
ABITIG® 150F Little	4 m	ED	BSB 10-25 Tuchel 3-pol.	High Flex Leder	7L6FH043512213B06	190.22
	8 m	ED	BSB 10-25 Tuchel 3-pol.	High Flex Leder	7L6FH083512213B06	240.81

ABITIG® GRIP / ABITIG® GRIP Little-Brennerpreisliste

passend für WIG-Stromquellen des Fabrikates „kjellberg“



Brennertyp	Länge	Schalterfunktion	maschinenseitiger Anschluss	Schlauchpaketausführung	Bestellnummer	Preis (€)
ABITIG® 9	4 m	ED	BSB 35-50 Tuchel 3-pol.	Standard	7S1SK043510013B06	101.10
	8 m	ED	BSB 35-50 Tuchel 3-pol.	Standard	7S1SK083510013B06	125.24
	4 m	ED	BSB 35-50 Tuchel 3-pol.	High Flex Leder	7S1SH043510013B06	137.32
	8 m	ED	BSB 35-50 Tuchel 3-pol.	High Flex Leder	7S1SH083510013B06	170.91
ABITIG® 9 Little	4 m	ED	BSB 35-50 Tuchel 3-pol.	High Flex Leder	7L1SH043510013B06	137.32
	8 m	ED	BSB 35-50 Tuchel 3-pol.	High Flex Leder	7L1SH083510013B06	170.91
ABITIG® 9F	4 m	ED	BSB 35-50 Tuchel 3-pol.	Standard	7S1FK043510013B06	106.89
	8 m	ED	BSB 35-50 Tuchel 3-pol.	Standard	7S1FK083510013B06	131.03
	4 m	ED	BSB 35-50 Tuchel 3-pol.	High Flex Leder	7S1FH043510013B06	143.11
	8 m	ED	BSB 35-50 Tuchel 3-pol.	High Flex Leder	7S1FH083510013B06	176.70
ABITIG® 9F Little	4 m	ED	BSB 35-50 Tuchel 3-pol.	High Flex Leder	7L1FH043510013B06	143.11
	8 m	ED	BSB 35-50 Tuchel 3-pol.	High Flex Leder	7L1FH083510013B06	176.70
ABITIG® 17	4 m	ED	BSB 35-50 Tuchel 3-pol.	Standard	7S2SK043510013B06	104.35
	8 m	ED	BSB 35-50 Tuchel 3-pol.	Standard	7S2SK083510013B06	128.49
	4 m	ED	BSB 35-50 Tuchel 3-pol.	High Flex Leder	7S2SH043510013B06	145.80
	8 m	ED	BSB 35-50 Tuchel 3-pol.	High Flex Leder	7S2SH083510013B06	186.27
ABITIG® 17 Little	4 m	ED	BSB 35-50 Tuchel 3-pol.	High Flex Leder	7L2SH043510013B06	145.80
	8 m	ED	BSB 35-50 Tuchel 3-pol.	High Flex Leder	7L2SH083510013B06	186.27
ABITIG® 17F	4 m	ED	BSB 35-50 Tuchel 3-pol.	Standard	7S2FK043510013B06	107.78
	8 m	ED	BSB 35-50 Tuchel 3-pol.	Standard	7S2FK083510013B06	131.92
	4 m	ED	BSB 35-50 Tuchel 3-pol.	High Flex Leder	7S2FH043510013B06	149.23
	8 m	ED	BSB 35-50 Tuchel 3-pol.	High Flex Leder	7S2FH083510013B06	189.70
ABITIG® 17F Little	4 m	ED	BSB 35-50 Tuchel 3-pol.	High Flex Leder	7L2FH043510013B06	149.23
	8 m	ED	BSB 35-50 Tuchel 3-pol.	High Flex Leder	7L2FH083510013B06	189.70

Technische Änderungen vorbehalten • Verkaufspreise = unverbindliche Preisempfehlung - Angebot freibleibend • © Copyright

ABITIG® GRIP / ABITIG® GRIP Little-Brennerpreisliste

passend für WIG-Stromquellen des Fabrikates „kjellberg“

Brennertyp	Länge	Schalterfunktion	maschinenseitiger Anschluss	Schlauchpaketausführung	Bestellnummer	Preis (€)
ABITIG® 26	4 m	ED	BSB 35-50 Tuchel 3-pol.	Standard	7S3SK043510013B06	111.36
	8 m	ED	BSB 35-50 Tuchel 3-pol.	Standard	7S3SK083510013B06	141.94
	4 m	ED	BSB 35-50 Tuchel 3-pol.	High Flex Leder	7S3SH043510013B06	150.01
	8 m	ED	BSB 35-50 Tuchel 3-pol.	High Flex Leder	7S3SH083510013B06	195.20
ABITIG® 26F	4 m	ED	BSB 35-50 Tuchel 3-pol.	Standard	7S3FK043510013B06	117.76
	8 m	ED	BSB 35-50 Tuchel 3-pol.	Standard	7S3FK083510013B06	148.34
	4 m	ED	BSB 35-50 Tuchel 3-pol.	High Flex Leder	7S3FH043510013B06	156.41
	8 m	ED	BSB 35-50 Tuchel 3-pol.	High Flex Leder	7S3FH083510013B06	201.60
ABITIG® 24G	4 m	ED	BSB 35-50 Tuchel 3-pol.	Standard	7S8SK043510013B06	113.54
	8 m	ED	BSB 35-50 Tuchel 3-pol.	Standard	7S8SK083510013B06	137.68
	4 m	ED	BSB 35-50 Tuchel 3-pol.	High Flex Leder	7S8SH043510013B06	154.99
	8 m	ED	BSB 35-50 Tuchel 3-pol.	High Flex Leder	7S8SH083510013B06	195.46
ABITIG® 24G Little	4 m	ED	BSB 35-50 Tuchel 3-pol.	High Flex Leder	7L8SH043510013B06	154.99
	8 m	ED	BSB 35-50 Tuchel 3-pol.	High Flex Leder	7L8SH083510013B06	195.46
ABITIG® 200	4 m	ED	BSB 35-50 Tuchel 3-pol.	Standard	7T4SK043510013B06	145.46
	8 m	ED	BSB 35-50 Tuchel 3-pol.	Standard	7T4SK083510013B06	184.46
	4 m	ED	BSB 35-50 Tuchel 3-pol.	High Flex Leder	7T4SH043510013B06	195.43
	8 m	ED	BSB 35-50 Tuchel 3-pol.	High Flex Leder	7T4SH083510013B06	253.54
ABITIG® 200F	4 m	ED	BSB 35-50 Tuchel 3-pol.	Standard	7T4FK043510013B06	154.62
	8 m	ED	BSB 35-50 Tuchel 3-pol.	Standard	7T4FK083510013B06	193.62
	4 m	ED	BSB 35-50 Tuchel 3-pol.	High Flex Leder	7T4FH043510013B06	204.59
	8 m	ED	BSB 35-50 Tuchel 3-pol.	High Flex Leder	7T4FH083510013B06	262.70
ABITIG® 150	4 m	ED	BSB 35-50 Tuchel 3-pol.	Standard	7T6SK043510013B06	138.29
	8 m	ED	BSB 35-50 Tuchel 3-pol.	Standard	7T6SK083510013B06	168.17
	4 m	ED	BSB 35-50 Tuchel 3-pol.	High Flex Leder	7T6SH043510013B06	190.40
	8 m	ED	BSB 35-50 Tuchel 3-pol.	High Flex Leder	7T6SH083510013B06	240.99
ABITIG® 150 Little	4 m	ED	BSB 35-50 Tuchel 3-pol.	High Flex Leder	7L6SH043510013B06	190.40
	8 m	ED	BSB 35-50 Tuchel 3-pol.	High Flex Leder	7L6SH083510013B06	240.99
ABITIG® 150F	4 m	ED	BSB 35-50 Tuchel 3-pol.	Standard	7T6FK043510013B06	138.48
	8 m	ED	BSB 35-50 Tuchel 3-pol.	Standard	7T6FK083510013B06	168.36
	4 m	ED	BSB 35-50 Tuchel 3-pol.	High Flex Leder	7T6FH043510013B06	190.59
	8 m	ED	BSB 35-50 Tuchel 3-pol.	High Flex Leder	7T6FH083510013B06	241.18
ABITIG® 150F Little	4 m	ED	BSB 35-50 Tuchel 3-pol.	High Flex Leder	7L6FH043510013B06	190.59
	8 m	ED	BSB 35-50 Tuchel 3-pol.	High Flex Leder	7L6FH083510013B06	241.18

ABITIG® GRIP / ABITIG® GRIP Little-Brennerpreisliste

passend für WIG-Stromquellen des Fabrikates „kjellberg“



Brennertyp	Länge	Schalterfunktion	maschinenseitiger Anschluss	Schlauchpaketausführung	Bestellnummer	Preis (€)
ABITIG® 9	4 m	DD	BSB 35-50 Tuchel - 5 pol.	Standard	7S1SK043520026B06	103.33
	8 m	DD	BSB 35-50 Tuchel - 5 pol.	Standard	7S1SK083520026B06	127.47
	4 m	DD	BSB 35-50 Tuchel - 5 pol.	High Flex Leder	7S1SH043520026B06	139.55
	8 m	DD	BSB 35-50 Tuchel - 5 pol.	High Flex Leder	7S1SH083520026B06	173.14
ABITIG® 9 Little	4 m	DD	BSB 35-50 Tuchel - 5 pol.	High Flex Leder	7L1SH043520026B06	139.55
	8 m	DD	BSB 35-50 Tuchel - 5 pol.	High Flex Leder	7L1SH083520026B06	173.14
ABITIG® 9F	4 m	DD	BSB 35-50 Tuchel - 5 pol.	Standard	7S1FK043520026B06	109.12
	8 m	DD	BSB 35-50 Tuchel - 5 pol.	Standard	7S1FK083520026B06	133.26
	4 m	DD	BSB 35-50 Tuchel - 5 pol.	High Flex Leder	7S1FH043520026B06	145.34
	8 m	DD	BSB 35-50 Tuchel - 5 pol.	High Flex Leder	7S1FH083520026B06	178.93
ABITIG® 9F Little	4 m	DD	BSB 35-50 Tuchel - 5 pol.	High Flex Leder	7L1FH043520026B06	145.34
	8 m	DD	BSB 35-50 Tuchel - 5 pol.	High Flex Leder	7L1FH083520026B06	178.93
ABITIG® 17	4 m	DD	BSB 35-50 Tuchel - 5 pol.	Standard	7S2SK043520026B06	106.58
	8 m	DD	BSB 35-50 Tuchel - 5 pol.	Standard	7S2SK083520026B06	130.72
	4 m	DD	BSB 35-50 Tuchel - 5 pol.	High Flex Leder	7S2SH043520026B06	148.03
	8 m	DD	BSB 35-50 Tuchel - 5 pol.	High Flex Leder	7S2SH083520026B06	188.50
ABITIG® 17 Little	4 m	DD	BSB 35-50 Tuchel - 5 pol.	High Flex Leder	7L2SH043520026B06	148.03
	8 m	DD	BSB 35-50 Tuchel - 5 pol.	High Flex Leder	7L2SH083520026B06	188.50
ABITIG® 17F	4 m	DD	BSB 35-50 Tuchel - 5 pol.	Standard	7S2FK043520026B06	110.01
	8 m	DD	BSB 35-50 Tuchel - 5 pol.	Standard	7S2FK083520026B06	134.15
	4 m	DD	BSB 35-50 Tuchel - 5 pol.	High Flex Leder	7S2FH043520026B06	151.46
	8 m	DD	BSB 35-50 Tuchel - 5 pol.	High Flex Leder	7S2FH083520026B06	191.93
ABITIG® 17F Little	4 m	DD	BSB 35-50 Tuchel - 5 pol.	High Flex Leder	7L2FH043520026B06	151.46
	8 m	DD	BSB 35-50 Tuchel - 5 pol.	High Flex Leder	7L2FH083520026B06	191.93

Technische Änderungen vorbehalten • Verkaufspreise = unverbindliche Preisempfehlung - Angebot freibleibend • © Copyright

ABITIG® GRIP / ABITIG® GRIP Little-Brennerpreisliste

passend für WIG-Stromquellen des Fabrikates „kjellberg“

Brennertyp	Länge	Schalterfunktion	maschinenseitiger Anschluss	Schlauchpaketausführung	Bestellnummer	Preis (€)
ABITIG® 26	4 m	DD	BSB 35-50 Tuchel - 5 pol.	Standard	7S3SK043520026B06	113.59
	8 m	DD	BSB 35-50 Tuchel - 5 pol.	Standard	7S3SK083520026B06	144.17
	4 m	DD	BSB 35-50 Tuchel - 5 pol.	High Flex Leder	7S3SH043520026B06	152.24
	8 m	DD	BSB 35-50 Tuchel - 5 pol.	High Flex Leder	7S3SH083520026B06	197.43
ABITIG® 26F	4 m	DD	BSB 35-50 Tuchel - 5 pol.	Standard	7S3FK043520026B06	119.99
	8 m	DD	BSB 35-50 Tuchel - 5 pol.	Standard	7S3FK083520026B06	150.57
	4 m	DD	BSB 35-50 Tuchel - 5 pol.	High Flex Leder	7S3FH043520026B06	158.64
	8 m	DD	BSB 35-50 Tuchel - 5 pol.	High Flex Leder	7S3FH083520026B06	203.83
ABITIG® 24G	4 m	DD	BSB 35-50 Tuchel - 5 pol.	Standard	7S8SK043520026B06	115.77
	8 m	DD	BSB 35-50 Tuchel - 5 pol.	Standard	7S8SK083520026B06	139.91
	4 m	DD	BSB 35-50 Tuchel - 5 pol.	High Flex Leder	7S8SH043520026B06	157.22
	8 m	DD	BSB 35-50 Tuchel - 5 pol.	High Flex Leder	7S8SH083520026B06	197.69
ABITIG® 24G Little	4 m	DD	BSB 35-50 Tuchel - 5 pol.	High Flex Leder	7L8SH043520026B06	157.22
	8 m	DD	BSB 35-50 Tuchel - 5 pol.	High Flex Leder	7L8SH083520026B06	197.69
ABITIG® 200	4 m	DD	BSB 35-50 Tuchel - 5 pol.	Standard	7T4SK043520026B06	148.35
	8 m	DD	BSB 35-50 Tuchel - 5 pol.	Standard	7T4SK083520026B06	187.35
	4 m	DD	BSB 35-50 Tuchel - 5 pol.	High Flex Leder	7T4SH043520026B06	198.32
	8 m	DD	BSB 35-50 Tuchel - 5 pol.	High Flex Leder	7T4SH083520026B06	256.43
ABITIG® 200F	4 m	DD	BSB 35-50 Tuchel - 5 pol.	Standard	7T4FK043520026B06	157.51
	8 m	DD	BSB 35-50 Tuchel - 5 pol.	Standard	7T4FK083520026B06	196.51
	4 m	DD	BSB 35-50 Tuchel - 5 pol.	High Flex Leder	7T4FH043520026B06	207.48
	8 m	DD	BSB 35-50 Tuchel - 5 pol.	High Flex Leder	7T4FH083520026B06	265.59
ABITIG® 150	4 m	DD	BSB 35-50 Tuchel - 5 pol.	Standard	7T6SK043520026B06	141.10
	8 m	DD	BSB 35-50 Tuchel - 5 pol.	Standard	7T6SK083520026B06	170.98
	4 m	DD	BSB 35-50 Tuchel - 5 pol.	High Flex Leder	7T6SH043520026B06	193.21
	8 m	DD	BSB 35-50 Tuchel - 5 pol.	High Flex Leder	7T6SH083520026B06	243.80
ABITIG® 150 Little	4 m	DD	BSB 35-50 Tuchel - 5 pol.	High Flex Leder	7L6SH043520026B06	193.21
	8 m	DD	BSB 35-50 Tuchel - 5 pol.	High Flex Leder	7L6SH083520026B06	243.80
ABITIG® 150F	4 m	DD	BSB 35-50 Tuchel - 5 pol.	Standard	7T6FK043520026B06	141.29
	8 m	DD	BSB 35-50 Tuchel - 5 pol.	Standard	7T6FK083520026B06	171.17
	4 m	DD	BSB 35-50 Tuchel - 5 pol.	High Flex Leder	7T6FH043520026B06	193.40
	8 m	DD	BSB 35-50 Tuchel - 5 pol.	High Flex Leder	7T6FH083520026B06	243.99
ABITIG® 150F Little	4 m	DD	BSB 35-50 Tuchel - 5 pol.	High Flex Leder	7L6FH043520026B06	193.40
	8 m	DD	BSB 35-50 Tuchel - 5 pol.	High Flex Leder	7L6FH083520026B06	243.99

ABITIG® GRIP / ABITIG® GRIP Little-Brennerpreisliste

passend für WIG-Stromquellen des Fabrikates „kjellberg“



Brennertyp	Länge	Schalterfunktion	maschinenseitiger Anschluss	Schlauchpaketausführung	Bestellnummer	Preis (€)
ABITIG® 9	4 m	EDP	BSB 10-25 Tuchel 7-pol.	Standard	7S1SK046542227A06	151.08
	8 m	EDP	BSB 10-25 Tuchel 7-pol.	Standard	7S1SK086542227A06	176.07
	4 m	EDP	BSB 10-25 Tuchel 7-pol.	High Flex Leder	7S1SH046542227A06	187.29
	8 m	EDP	BSB 10-25 Tuchel 7-pol.	High Flex Leder	7S1SH086542227A06	221.71

ABITIG® 9F	4 m	EDP	BSB 10-25 Tuchel 7-pol.	Standard	7S1FK046542227A06	156.87
	8 m	EDP	BSB 10-25 Tuchel 7-pol.	Standard	7S1FK086542227A06	181.86
	4 m	EDP	BSB 10-25 Tuchel 7-pol.	High Flex Leder	7S1FH046542227A06	193.08
	8 m	EDP	BSB 10-25 Tuchel 7-pol.	High Flex Leder	7S1FH086542227A06	227.50

ABITIG® 17	4 m	EDP	BSB 10-25 Tuchel 7-pol.	Standard	7S2SK046542227A06	154.33
	8 m	EDP	BSB 10-25 Tuchel 7-pol.	Standard	7S2SK086542227A06	179.32
	4 m	EDP	BSB 10-25 Tuchel 7-pol.	High Flex Leder	7S2SH046542227A06	195.73
	8 m	EDP	BSB 10-25 Tuchel 7-pol.	High Flex Leder	7S2SH086542227A06	237.09

ABITIG® 17F	4 m	EDP	BSB 10-25 Tuchel 7-pol.	Standard	7S2FK046542227A06	157.76
	8 m	EDP	BSB 10-25 Tuchel 7-pol.	Standard	7S2FK086542227A06	182.75
	4 m	EDP	BSB 10-25 Tuchel 7-pol.	High Flex Leder	7S2FH046542227A06	199.16
	8 m	EDP	BSB 10-25 Tuchel 7-pol.	High Flex Leder	7S2FH086542227A06	240.52

Technische Änderungen vorbehalten • Verkaufspreise = unverbindliche Preisempfehlung - Angebot freibleibend • © Copyright

ABITIG® GRIP / ABITIG® GRIP Little-Brennerpreisliste

passend für WIG-Stromquellen des Fabrikates „kjellberg“



Brennertyp	Länge	Schalterfunktion	maschinenseitiger Anschluss	Schlauchpaketausführung	Bestellnummer	Preis (€)
ABITIG® 9	4 m	EDP	BSB 35-50 Tuchel 7-pol.	Standard	7S1SK046540027A06	151.37
	8 m	EDP	BSB 35-50 Tuchel 7-pol.	Standard	7S1SK086540027A06	176.36
	4 m	EDP	BSB 35-50 Tuchel 7-pol.	High Flex Leder	7S1SH046540027A06	187.58
	8 m	EDP	BSB 35-50 Tuchel 7-pol.	High Flex Leder	7S1SH086540027A06	222.00
ABITIG® 9F	4 m	EDP	BSB 35-50 Tuchel 7-pol.	Standard	7S1FK046540027A06	157.16
	8 m	EDP	BSB 35-50 Tuchel 7-pol.	Standard	7S1FK086540027A06	182.15
	4 m	EDP	BSB 35-50 Tuchel 7-pol.	High Flex Leder	7S1FH046540027A06	193.37
	8 m	EDP	BSB 35-50 Tuchel 7-pol.	High Flex Leder	7S1FH086540027A06	227.79
ABITIG® 17	4 m	EDP	BSB 35-50 Tuchel 7-pol.	Standard	7S2SK046540027A06	154.62
	8 m	EDP	BSB 35-50 Tuchel 7-pol.	Standard	7S2SK086540027A06	179.61
	4 m	EDP	BSB 35-50 Tuchel 7-pol.	High Flex Leder	7S2SH046540027A06	196.02
	8 m	EDP	BSB 35-50 Tuchel 7-pol.	High Flex Leder	7S2SH086540027A06	237.38
ABITIG® 17F	4 m	EDP	BSB 35-50 Tuchel 7-pol.	Standard	7S2FK046540027A06	158.05
	8 m	EDP	BSB 35-50 Tuchel 7-pol.	Standard	7S2FK086540027A06	183.04
	4 m	EDP	BSB 35-50 Tuchel 7-pol.	High Flex Leder	7S2FH046540027A06	199.45
	8 m	EDP	BSB 35-50 Tuchel 7-pol.	High Flex Leder	7S2FH086540027A06	240.81

Technische Änderungen vorbehalten • Verkaufspreise = unverbindliche Preisempfehlung - Angebot freibleibend • © Copyright

ABITIG® GRIP / ABITIG® GRIP Little-Brennerpreisliste

passend für WIG-Stromquellen des Fabrikates „kjellberg“

Brennertyp	Länge	Schalterfunktion	maschinenseitiger Anschluss	Schlauchpaketausführung	Bestellnummer	Preis (€)
ABITIG® 26	4 m	EDP	BSB 35-50 Tuchel 7-pol.	Standard	7S3SK046540027A06	161.59
	8 m	EDP	BSB 35-50 Tuchel 7-pol.	Standard	7S3SK086540027A06	193.02
	4 m	EDP	BSB 35-50 Tuchel 7-pol.	High Flex Leder	7S3SH046540027A06	200.23
	8 m	EDP	BSB 35-50 Tuchel 7-pol.	High Flex Leder	7S3SH086540027A06	246.28
ABITIG® 26F	4 m	EDP	BSB 35-50 Tuchel 7-pol.	Standard	7S3FK046540027A06	167.99
	8 m	EDP	BSB 35-50 Tuchel 7-pol.	Standard	7S3FK086540027A06	199.42
	4 m	EDP	BSB 35-50 Tuchel 7-pol.	High Flex Leder	7S3FH046540027A06	206.63
	8 m	EDP	BSB 35-50 Tuchel 7-pol.	High Flex Leder	7S3FH086540027A06	252.68
ABITIG® 24G	4 m	EDP	BSB 35-50 Tuchel 7-pol.	Standard	7S8SK046540027A06	163.81
	8 m	EDP	BSB 35-50 Tuchel 7-pol.	Standard	7S8SK086540027A06	188.80
	4 m	EDP	BSB 35-50 Tuchel 7-pol.	High Flex Leder	7S8SH046540027A06	205.21
	8 m	EDP	BSB 35-50 Tuchel 7-pol.	High Flex Leder	7S8SH086540027A06	246.57
ABITIG® 200	4 m	EDP	BSB 35-50 Tuchel 7-pol.	Standard	7T4SK046540027A06	209.26
	8 m	EDP	BSB 35-50 Tuchel 7-pol.	Standard	7T4SK086540027A06	250.13
	4 m	EDP	BSB 35-50 Tuchel 7-pol.	High Flex Leder	7T4SH046540027A06	260.01
	8 m	EDP	BSB 35-50 Tuchel 7-pol.	High Flex Leder	7T4SH086540027A06	319.21
ABITIG® 200F	4 m	EDP	BSB 35-50 Tuchel 7-pol.	Standard	7T4FK046540027A06	218.42
	8 m	EDP	BSB 35-50 Tuchel 7-pol.	Standard	7T4FK086540027A06	259.29
	4 m	EDP	BSB 35-50 Tuchel 7-pol.	High Flex Leder	7T4FH046540027A06	269.17
	8 m	EDP	BSB 35-50 Tuchel 7-pol.	High Flex Leder	7T4FH086540027A06	328.37
ABITIG® 150	4 m	EDP	BSB 35-50 Tuchel 7-pol.	Standard	7T6SK046540027A06	201.07
	8 m	EDP	BSB 35-50 Tuchel 7-pol.	Standard	7T6SK086540027A06	232.02
	4 m	EDP	BSB 35-50 Tuchel 7-pol.	High Flex Leder	7T6SH046540027A06	253.18
	8 m	EDP	BSB 35-50 Tuchel 7-pol.	High Flex Leder	7T6SH086540027A06	304.83
ABITIG® 150F	4 m	EDP	BSB 35-50 Tuchel 7-pol.	Standard	7T6FK046540027A06	201.26
	8 m	EDP	BSB 35-50 Tuchel 7-pol.	Standard	7T6FK086540027A06	232.21
	4 m	EDP	BSB 35-50 Tuchel 7-pol.	High Flex Leder	7T6FH046540027A06	253.37
	8 m	EDP	BSB 35-50 Tuchel 7-pol.	High Flex Leder	7T6FH086540027A06	305.02

ABITIG® GRIP / ABITIG® GRIP Little-Brennerpreisliste

passend für WIG-Stromquellen des Fabrikates „kjellberg“

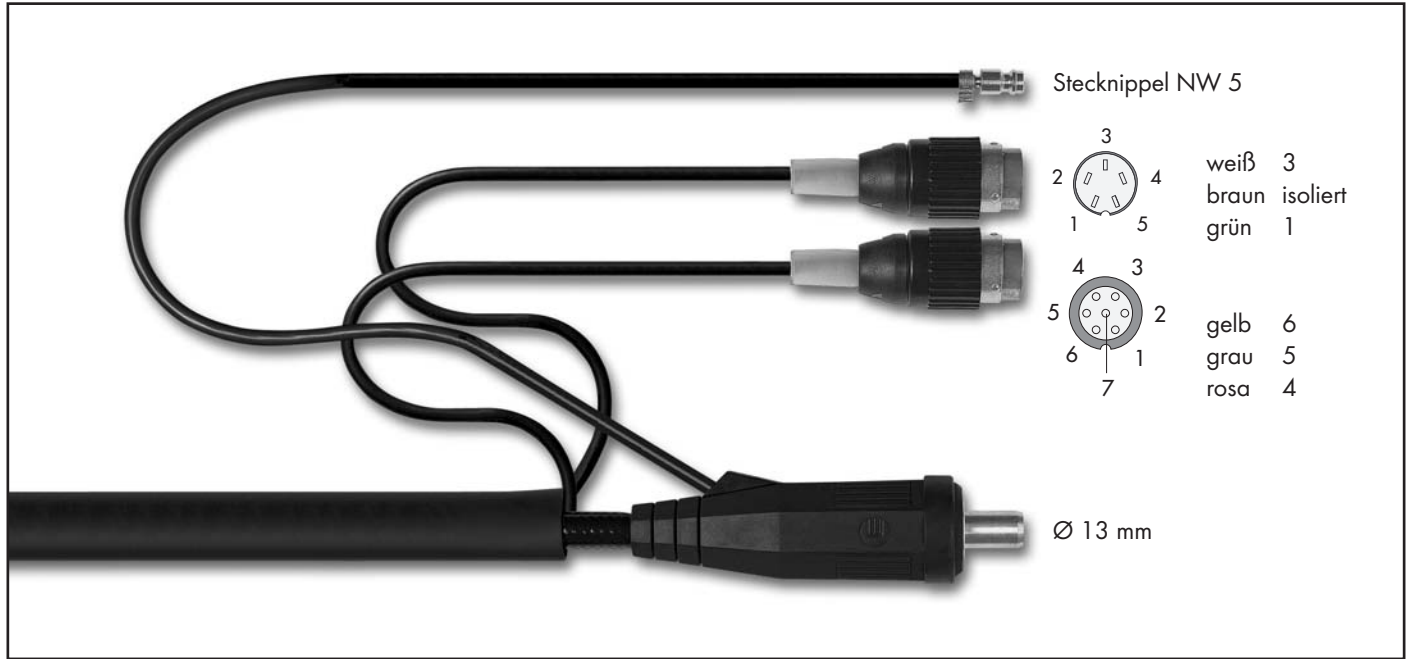

Brennertyp	Länge	Schalterfunktion	maschinenseitiger Anschluss	Schlauchpaketausführung	Bestellnummer	Preis (€)
ABITIG® 9	4 m	EDP	BSB 35-50 Tuchel 5-pol./ 7-pol.	Standard	7S1SK046540042A06	170.60
	8 m	EDP	BSB 35-50 Tuchel 5-pol./ 7-pol.	Standard	7S1SK086540042A06	195.59
	4 m	EDP	BSB 35-50 Tuchel 5-pol./ 7-pol.	High Flex Leder	7S1SH046540042A06	206.81
	8 m	EDP	BSB 35-50 Tuchel 5-pol./ 7-pol.	High Flex Leder	7S1SH086540042A06	241.23

ABITIG® 9F	4 m	EDP	BSB 35-50 Tuchel 5-pol./ 7-pol.	Standard	7S1FK046540042A06	176.39
	8 m	EDP	BSB 35-50 Tuchel 5-pol./ 7-pol.	Standard	7S1FK086540042A06	201.38
	4 m	EDP	BSB 35-50 Tuchel 5-pol./ 7-pol.	High Flex Leder	7S1FH046540042A06	212.60
	8 m	EDP	BSB 35-50 Tuchel 5-pol./ 7-pol.	High Flex Leder	7S1FH086540042A06	247.02

ABITIG® 17	4 m	EDP	BSB 35-50 Tuchel 5-pol./ 7-pol.	Standard	7S2SK046540042A06	173.85
	8 m	EDP	BSB 35-50 Tuchel 5-pol./ 7-pol.	Standard	7S2SK086540042A06	198.84
	4 m	EDP	BSB 35-50 Tuchel 5-pol./ 7-pol.	High Flex Leder	7S2SH046540042A06	215.25
	8 m	EDP	BSB 35-50 Tuchel 5-pol./ 7-pol.	High Flex Leder	7S2SH086540042A06	256.61

ABITIG® 17F	4 m	EDP	BSB 35-50 Tuchel 5-pol./ 7-pol.	Standard	7S2FK046540042A06	177.28
	8 m	EDP	BSB 35-50 Tuchel 5-pol./ 7-pol.	Standard	7S2FK086540042A06	202.27
	4 m	EDP	BSB 35-50 Tuchel 5-pol./ 7-pol.	High Flex Leder	7S2FH046540042A06	218.68
	8 m	EDP	BSB 35-50 Tuchel 5-pol./ 7-pol.	High Flex Leder	7S2FH086540042A06	260.04

Technische Änderungen vorbehalten • Verkaufspreise = unverbindliche Preisempfehlung - Angebot freibleibend • © Copyright

ABITIG® GRIP / ABITIG® GRIP Little-Brennerpreisliste

passend für WIG-Stromquellen des Fabrikates „kjellberg“

Brennertyp	Länge	Schalterfunktion	maschinenseitiger Anschluss	Schlauchpaketausführung	Bestellnummer	Preis (€)
ABITIG® 26	4 m	EDP	BSB 35-50 Tuchel 5-pol./ 7-pol.	Standard	7S3SK046540042A06	180.82
	8 m	EDP	BSB 35-50 Tuchel 5-pol./ 7-pol.	Standard	7S3SK086540042A06	212.25
	4 m	EDP	BSB 35-50 Tuchel 5-pol./ 7-pol.	High Flex Leder	7S3SH046540042A06	219.46
	8 m	EDP	BSB 35-50 Tuchel 5-pol./ 7-pol.	High Flex Leder	7S3SH086540042A06	265.51
ABITIG® 26F	4 m	EDP	BSB 35-50 Tuchel 5-pol./ 7-pol.	Standard	7S3FK046540042A06	187.22
	8 m	EDP	BSB 35-50 Tuchel 5-pol./ 7-pol.	Standard	7S3FK086540042A06	218.65
	4 m	EDP	BSB 35-50 Tuchel 5-pol./ 7-pol.	High Flex Leder	7S3FH046540042A06	225.86
	8 m	EDP	BSB 35-50 Tuchel 5-pol./ 7-pol.	High Flex Leder	7S3FH086540042A06	271.91
ABITIG® 24G	4 m	EDP	BSB 35-50 Tuchel 5-pol./ 7-pol.	Standard	7S8SK046540042A06	183.04
	8 m	EDP	BSB 35-50 Tuchel 5-pol./ 7-pol.	Standard	7S8SK086540042A06	208.03
	4 m	EDP	BSB 35-50 Tuchel 5-pol./ 7-pol.	High Flex Leder	7S8SH046540042A06	224.44
	8 m	EDP	BSB 35-50 Tuchel 5-pol./ 7-pol.	High Flex Leder	7S8SH086540042A06	265.80
ABITIG® 200	4 m	EDP	BSB 35-50 Tuchel 5-pol./ 7-pol.	Standard	7T4SK046540042A06	233.98
	8 m	EDP	BSB 35-50 Tuchel 5-pol./ 7-pol.	Standard	7T4SK086540042A06	274.85
	4 m	EDP	BSB 35-50 Tuchel 5-pol./ 7-pol.	High Flex Leder	7T4SH046540042A06	284.73
	8 m	EDP	BSB 35-50 Tuchel 5-pol./ 7-pol.	High Flex Leder	7T4SH086540042A06	343.93
ABITIG® 200F	4 m	EDP	BSB 35-50 Tuchel 5-pol./ 7-pol.	Standard	7T4FK046540042A06	243.14
	8 m	EDP	BSB 35-50 Tuchel 5-pol./ 7-pol.	Standard	7T4FK086540042A06	284.01
	4 m	EDP	BSB 35-50 Tuchel 5-pol./ 7-pol.	High Flex Leder	7T4FH046540042A06	293.89
	8 m	EDP	BSB 35-50 Tuchel 5-pol./ 7-pol.	High Flex Leder	7T4FH086540042A06	353.09
ABITIG® 150	4 m	EDP	BSB 35-50 Tuchel 5-pol./ 7-pol.	Standard	7T6SK046540042A06	225.10
	8 m	EDP	BSB 35-50 Tuchel 5-pol./ 7-pol.	Standard	7T6SK086540042A06	256.05
	4 m	EDP	BSB 35-50 Tuchel 5-pol./ 7-pol.	High Flex Leder	7T6SH046540042A06	277.21
	8 m	EDP	BSB 35-50 Tuchel 5-pol./ 7-pol.	High Flex Leder	7T6SH086540042A06	328.86
ABITIG® 150F	4 m	EDP	BSB 35-50 Tuchel 5-pol./ 7-pol.	Standard	7T6FK046540042A06	225.29
	8 m	EDP	BSB 35-50 Tuchel 5-pol./ 7-pol.	Standard	7T6FK086540042A06	256.24
	4 m	EDP	BSB 35-50 Tuchel 5-pol./ 7-pol.	High Flex Leder	7T6FH046540042A06	277.40
	8 m	EDP	BSB 35-50 Tuchel 5-pol./ 7-pol.	High Flex Leder	7T6FH086540042A06	329.05

ABITIG® GRIP / ABITIG® GRIP Little-Brennerpreisliste

passend für WIG-Stromquellen des Fabrikates „kjellberg“



Brennertyp	Länge	Schalterfunktion	maschinenseitiger Anschluss	Schlauchpaketausführung	Bestellnummer
ABITIG® 18	4 m	ED	BSB 35-50 Tuchel 5-pol.	Standard	7S4SK043510014A20
	8 m	ED	BSB 35-50 Tuchel 5-pol.	Standard	7S4SK083510014A20
	4 m	ED	BSB 35-50 Tuchel 5-pol.	High Flex Leder	7S4SH043510014A20
	8 m	ED	BSB 35-50 Tuchel 5-pol.	High Flex Leder	7S4SH083510014A20
ABITIG® 18F	4 m	ED	BSB 35-50 Tuchel 5-pol.	Standard	7S4FK043510014A20
	8 m	ED	BSB 35-50 Tuchel 5-pol.	Standard	7S4FK083510014A20
	4 m	ED	BSB 35-50 Tuchel 5-pol.	High Flex Leder	7S4FH043510014A20
	8 m	ED	BSB 35-50 Tuchel 5-pol.	High Flex Leder	7S4FH083510014A20
ABITIG® 20	4 m	ED	BSB 35-50 Tuchel 5-pol.	Standard	7S5SK043510014A20
	8 m	ED	BSB 35-50 Tuchel 5-pol.	Standard	7S5SK083510014A20
	4 m	ED	BSB 35-50 Tuchel 5-pol.	High Flex Leder	7S5SH043510014A20
	8 m	ED	BSB 35-50 Tuchel 5-pol.	High Flex Leder	7S5SH083510014A20
ABITIG® 20 Little	4 m	ED	BSB 35-50 Tuchel 5-pol.	High Flex Leder	7L5SH043510014A20
	8 m	ED	BSB 35-50 Tuchel 5-pol.	High Flex Leder	7L5SH083510014A20
ABITIG® 20F	4 m	ED	BSB 35-50 Tuchel 5-pol.	Standard	7S5FK043510014A20
	8 m	ED	BSB 35-50 Tuchel 5-pol.	Standard	7S5FK083510014A20
	4 m	ED	BSB 35-50 Tuchel 5-pol.	High Flex Leder	7S5FH043510014A20
	8 m	ED	BSB 35-50 Tuchel 5-pol.	High Flex Leder	7S5FH083510014A20
ABITIG® 20F Little	4 m	ED	BSB 35-50 Tuchel 5-pol.	High Flex Leder	7L5FH043510014A20
	8 m	ED	BSB 35-50 Tuchel 5-pol.	High Flex Leder	7L5FH083510014A20

Technische Änderungen vorbehalten • Verkaufspreise = unverbindliche Preisempfehlung - Angebot freibleibend • © Copyright

ABITIG® GRIP / ABITIG® GRIP Little-Brennerpreisliste

passend für WIG-Stromquellen des Fabrikates „kjellberg“

Brennertyp	Länge	Schalterfunktion	maschinenseitiger Anschluss	Schlauchpaketausführung	Bestellnummer
ABITIG® 12-1	4 m	ED	BSB 35-50 Tuchel 5-pol.	Standard	7S6SK043510014A20
	8 m	ED	BSB 35-50 Tuchel 5-pol.	Standard	7S6SK083510014A20
	4 m	ED	BSB 35-50 Tuchel 5-pol.	High Flex Leder	7S6SH043510014A20
	8 m	ED	BSB 35-50 Tuchel 5-pol.	High Flex Leder	7S6SH083510014A20
ABITIG® 18SC	4 m	ED	BSB 35-50 Tuchel 5-pol.	Standard	7S7SK043510014A20
	8 m	ED	BSB 35-50 Tuchel 5-pol.	Standard	7S7SK083510014A20
	4 m	ED	BSB 35-50 Tuchel 5-pol.	High Flex Leder	7S7SH043510014A20
	8 m	ED	BSB 35-50 Tuchel 5-pol.	High Flex Leder	7S7SH083510014A20
ABITIG® 24W	4 m	ED	BSB 35-50 Tuchel 5-pol.	Standard	7S9SK043510014A20
	8 m	ED	BSB 35-50 Tuchel 5-pol.	Standard	7S9SK083510014A20
	4 m	ED	BSB 35-50 Tuchel 5-pol.	High Flex Leder	7S9SH043510014A20
	8 m	ED	BSB 35-50 Tuchel 5-pol.	High Flex Leder	7S9SH083510014A20
ABITIG® 24W Little	4 m	ED	BSB 35-50 Tuchel 5-pol.	High Flex Leder	7L9SH043510014A20
	8 m	ED	BSB 35-50 Tuchel 5-pol.	High Flex Leder	7L9SH083510014A20
ABITIG® 450W	4 m	ED	BSB 35-50 Tuchel 5-pol.	Standard	7T5SK043510114A20
	8 m	ED	BSB 35-50 Tuchel 5-pol.	Standard	7T5SK083510114A20
	4 m	ED	BSB 35-50 Tuchel 5-pol.	High Flex Leder	7T5SH043510114A20
	8 m	ED	BSB 35-50 Tuchel 5-pol.	High Flex Leder	7T5SH083510114A20
ABITIG® 260W	4 m	ED	BSB 35-50 Tuchel 5-pol.	Standard	7T7SK043510114A20
	8 m	ED	BSB 35-50 Tuchel 5-pol.	Standard	7T7SK083510114A20
	4 m	ED	BSB 35-50 Tuchel 5-pol.	High Flex Leder	7T7SH043510114A20
	8 m	ED	BSB 35-50 Tuchel 5-pol.	High Flex Leder	7T7SH083510114A20
ABITIG® 260W Little	4 m	ED	BSB 35-50 Tuchel 5-pol.	High Flex Leder	7L7SH043510114A20
	8 m	ED	BSB 35-50 Tuchel 5-pol.	High Flex Leder	7L7SH083510114A20
ABITIG® 450W SC	4 m	ED	BSB 35-50 Tuchel 5-pol.	Standard	
	8 m	ED	BSB 35-50 Tuchel 5-pol.	Standard	
	4 m	ED	BSB 35-50 Tuchel 5-pol.	High Flex Leder	7T8SH043510114A20
	8 m	ED	BSB 35-50 Tuchel 5-pol.	High Flex Leder	7T8SH083510114A20

ABITIG® GRIP / ABITIG® GRIP Little-Brennerpreisliste

passend für WIG-Stromquellen des Fabrikates „kjellberg“



Brennertyp	Länge	Schalterfunktion	maschinenseitiger Anschluss	Schlauchpaketausführung	Bestellnummer
ABITIG® 18	4 m	ED	BSB 35-50 Tuchel 3-pol.	Standard	7S4SK043510013B20
	8 m	ED	BSB 35-50 Tuchel 3-pol.	Standard	7S4SK083510013B20
	4 m	ED	BSB 35-50 Tuchel 3-pol.	High Flex Leder	7S4SH043510013B20
	8 m	ED	BSB 35-50 Tuchel 3-pol.	High Flex Leder	7S4SH083510013B20
ABITIG® 18F	4 m	ED	BSB 35-50 Tuchel 3-pol.	Standard	7S4FK043510013B20
	8 m	ED	BSB 35-50 Tuchel 3-pol.	Standard	7S4FK083510013B20
	4 m	ED	BSB 35-50 Tuchel 3-pol.	High Flex Leder	7S4FH043510013B20
	8 m	ED	BSB 35-50 Tuchel 3-pol.	High Flex Leder	7S4FH083510013B20
ABITIG® 20	4 m	ED	BSB 35-50 Tuchel 3-pol.	Standard	7S5SK043510013B20
	8 m	ED	BSB 35-50 Tuchel 3-pol.	Standard	7S5SK083510013B20
	4 m	ED	BSB 35-50 Tuchel 3-pol.	High Flex Leder	7S5SH043510013B20
	8 m	ED	BSB 35-50 Tuchel 3-pol.	High Flex Leder	7S5SH083510013B20
ABITIG® 20 Little	4 m	ED	BSB 35-50 Tuchel 3-pol.	High Flex Leder	7L5SH043510013B20
	8 m	ED	BSB 35-50 Tuchel 3-pol.	High Flex Leder	7L5SH083510013B20
ABITIG® 20F	4 m	ED	BSB 35-50 Tuchel 3-pol.	Standard	7S5FK043510013B20
	8 m	ED	BSB 35-50 Tuchel 3-pol.	Standard	7S5FK083510013B20
	4 m	ED	BSB 35-50 Tuchel 3-pol.	High Flex Leder	7S5FH043510013B20
	8 m	ED	BSB 35-50 Tuchel 3-pol.	High Flex Leder	7S5FH083510013B20
ABITIG® 20F Little	4 m	ED	BSB 35-50 Tuchel 3-pol.	High Flex Leder	7L5FH043510013B20
	8 m	ED	BSB 35-50 Tuchel 3-pol.	High Flex Leder	7L5FH083510013B20

Technische Änderungen vorbehalten • Verkaufspreise = unverbindliche Preisempfehlung - Angebot freibleibend • © Copyright

ABITIG® GRIP / ABITIG® GRIP Little-Brennerpreisliste

passend für WIG-Stromquellen des Fabrikates „kjellberg“

Brennertyp	Länge	Schalterfunktion	maschinenseitiger Anschluss	Schlauchpaketausführung	Bestellnummer
ABITIG® 12-1	4 m	ED	BSB 35-50 Tuchel 3-pol.	Standard	7S6SK043510013B20
	8 m	ED	BSB 35-50 Tuchel 3-pol.	Standard	7S6SK083510013B20
	4 m	ED	BSB 35-50 Tuchel 3-pol.	High Flex Leder	7S6SH043510013B20
	8 m	ED	BSB 35-50 Tuchel 3-pol.	High Flex Leder	7S6SH083510013B20
ABITIG® 18SC	4 m	ED	BSB 35-50 Tuchel 3-pol.	Standard	7S7SK043510013B20
	8 m	ED	BSB 35-50 Tuchel 3-pol.	Standard	7S7SK083510013B20
	4 m	ED	BSB 35-50 Tuchel 3-pol.	High Flex Leder	7S7SH043510013B20
	8 m	ED	BSB 35-50 Tuchel 3-pol.	High Flex Leder	7S7SH083510013B20
ABITIG® 24W	4 m	ED	BSB 35-50 Tuchel 3-pol.	Standard	7S9SK043510013B20
	8 m	ED	BSB 35-50 Tuchel 3-pol.	Standard	7S9SK083510013B20
	4 m	ED	BSB 35-50 Tuchel 3-pol.	High Flex Leder	7S9SH043510013B20
	8 m	ED	BSB 35-50 Tuchel 3-pol.	High Flex Leder	7S9SH083510013B20
ABITIG® 24W Little	4 m	ED	BSB 35-50 Tuchel 3-pol.	High Flex Leder	7L9SH043510013B20
	8 m	ED	BSB 35-50 Tuchel 3-pol.	High Flex Leder	7L9SH083510013B20
ABITIG® 450W	4 m	ED	BSB 35-50 Tuchel 3-pol.	Standard	7T5SK043510113B20
	8 m	ED	BSB 35-50 Tuchel 3-pol.	Standard	7T5SK083510113B20
	4 m	ED	BSB 35-50 Tuchel 3-pol.	High Flex Leder	7T5SH043510113B20
	8 m	ED	BSB 35-50 Tuchel 3-pol.	High Flex Leder	7T5SH083510113B20
ABITIG® 260W	4 m	ED	BSB 35-50 Tuchel 3-pol.	Standard	7T7SK043510113B20
	8 m	ED	BSB 35-50 Tuchel 3-pol.	Standard	7T7SK083510113B20
	4 m	ED	BSB 35-50 Tuchel 3-pol.	High Flex Leder	7T7SH043510113B20
	8 m	ED	BSB 35-50 Tuchel 3-pol.	High Flex Leder	7T7SH083510113B20
ABITIG® 260W Little	4 m	ED	BSB 35-50 Tuchel 3-pol.	High Flex Leder	7L7SH043510113B20
	8 m	ED	BSB 35-50 Tuchel 3-pol.	High Flex Leder	7L7SH083510113B20
ABITIG® 450W SC	4 m	ED	BSB 35-50 Tuchel 3-pol.	Standard	
	8 m	ED	BSB 35-50 Tuchel 3-pol.	Standard	
	4 m	ED	BSB 35-50 Tuchel 3-pol.	High Flex Leder	7T8SH043510113B20
	8 m	ED	BSB 35-50 Tuchel 3-pol.	High Flex Leder	7T8SH083510113B20

ABITIG® GRIP / ABITIG® GRIP Little-Brennerpreisliste

passend für WIG-Stromquellen des Fabrikates „kjellberg“



Brennertyp	Länge	Schalterfunktion	maschinenseitiger Anschluss	Schlauchpaketausführung	Bestellnummer
ABITIG® 18	4 m	DD	BSB 35-50 Tuchel 5-pol.	Standard	7S4SK043520026C20
	8 m	DD	BSB 35-50 Tuchel 5-pol.	Standard	7S4SK083520026C20
	4 m	DD	BSB 35-50 Tuchel 5-pol.	High Flex Leder	7S4SH043520026C20
	8 m	DD	BSB 35-50 Tuchel 5-pol.	High Flex Leder	7S4SH083520026C20
ABITIG® 18F	4 m	DD	BSB 35-50 Tuchel 5-pol.	Standard	7S4FK043520026C20
	8 m	DD	BSB 35-50 Tuchel 5-pol.	Standard	7S4FK083520026C20
	4 m	DD	BSB 35-50 Tuchel 5-pol.	High Flex Leder	7S4FH043520026C20
	8 m	DD	BSB 35-50 Tuchel 5-pol.	High Flex Leder	7S4FH083520026C20
ABITIG® 20	4 m	DD	BSB 35-50 Tuchel 5-pol.	Standard	7S5SK043520026C20
	8 m	DD	BSB 35-50 Tuchel 5-pol.	Standard	7S5SK083520026C20
	4 m	DD	BSB 35-50 Tuchel 5-pol.	High Flex Leder	7S5SH043520026C20
	8 m	DD	BSB 35-50 Tuchel 5-pol.	High Flex Leder	7S5SH083520026C20
ABITIG® 20 Little	4 m	DD	BSB 35-50 Tuchel 5-pol.	High Flex Leder	7L5SH043520026C20
	8 m	DD	BSB 35-50 Tuchel 5-pol.	High Flex Leder	7L5SH083520026C20
ABITIG® 20F	4 m	DD	BSB 35-50 Tuchel 5-pol.	Standard	7S5FK043520026C20
	8 m	DD	BSB 35-50 Tuchel 5-pol.	Standard	7S5FK083520026C20
	4 m	DD	BSB 35-50 Tuchel 5-pol.	High Flex Leder	7S5FH043520026C20
	8 m	DD	BSB 35-50 Tuchel 5-pol.	High Flex Leder	7S5FH083520026C20
ABITIG® 20F Little	4 m	DD	BSB 35-50 Tuchel 5-pol.	High Flex Leder	7L5FH043520026C20
	8 m	DD	BSB 35-50 Tuchel 5-pol.	High Flex Leder	7L5FH083520026C20

Technische Änderungen vorbehalten • Verkaufspreise = unverbindliche Preisempfehlung - Angebot freibleibend • © Copyright

ABITIG® GRIP / ABITIG® GRIP Little-Brennerpreisliste

passend für WIG-Stromquellen des Fabrikates „kjellberg“

Brennertyp	Länge	Schalterfunktion	maschinenseitiger Anschluss	Schlauchpaketausführung	Bestellnummer
ABITIG® 12-1	4 m	DD	BSB 35-50 Tuchel 5-pol.	Standard	7S6SK043520026C20
	8 m	DD	BSB 35-50 Tuchel 5-pol.	Standard	7S6SK083520026C20
	4 m	DD	BSB 35-50 Tuchel 5-pol.	High Flex Leder	7S6SH043520026C20
	8 m	DD	BSB 35-50 Tuchel 5-pol.	High Flex Leder	7S6SH083520026C20
ABITIG® 18SC	4 m	DD	BSB 35-50 Tuchel 5-pol.	Standard	7S7SK043520026C20
	8 m	DD	BSB 35-50 Tuchel 5-pol.	Standard	7S7SK083520026C20
	4 m	DD	BSB 35-50 Tuchel 5-pol.	High Flex Leder	7S7SH043520026C20
	8 m	DD	BSB 35-50 Tuchel 5-pol.	High Flex Leder	7S7SH083520026C20
ABITIG® 24W	4 m	DD	BSB 35-50 Tuchel 5-pol.	Standard	7S9SK043520026C20
	8 m	DD	BSB 35-50 Tuchel 5-pol.	Standard	7S9SK083520026C20
	4 m	DD	BSB 35-50 Tuchel 5-pol.	High Flex Leder	7S9SH043520026C20
	8 m	DD	BSB 35-50 Tuchel 5-pol.	High Flex Leder	7S9SH083520026C20
ABITIG® 24W Little	4 m	DD	BSB 35-50 Tuchel 5-pol.	High Flex Leder	7L9SH043520026C20
	8 m	DD	BSB 35-50 Tuchel 5-pol.	High Flex Leder	7L9SH083520026C20
ABITIG® 450W	4 m	DD	BSB 35-50 Tuchel 5-pol.	Standard	7T5SK043520126C20
	8 m	DD	BSB 35-50 Tuchel 5-pol.	Standard	7T5SK083520126C20
	4 m	DD	BSB 35-50 Tuchel 5-pol.	High Flex Leder	7T5SH043520126C20
	8 m	DD	BSB 35-50 Tuchel 5-pol.	High Flex Leder	7T5SH083520126C20
ABITIG® 260W	4 m	DD	BSB 35-50 Tuchel 5-pol.	Standard	7T7SK043520126C20
	8 m	DD	BSB 35-50 Tuchel 5-pol.	Standard	7T7SK083520126C20
	4 m	DD	BSB 35-50 Tuchel 5-pol.	High Flex Leder	7T7SH043520126C20
	8 m	DD	BSB 35-50 Tuchel 5-pol.	High Flex Leder	7T7SH083520126C20
ABITIG® 260W Little	4 m	DD	BSB 35-50 Tuchel 5-pol.	High Flex Leder	7L7SH043520126C20
	8 m	DD	BSB 35-50 Tuchel 5-pol.	High Flex Leder	7L7SH083520126C20
ABITIG® 450W SC	4 m	DD	BSB 35-50 Tuchel 5-pol.	Standard	
	8 m	DD	BSB 35-50 Tuchel 5-pol.	Standard	
	4 m	DD	BSB 35-50 Tuchel 5-pol.	High Flex Leder	7T8SH043520126C20
	8 m	DD	BSB 35-50 Tuchel 5-pol.	High Flex Leder	7T8SH083520126C20

ABITIG® GRIP / ABITIG® GRIP Little-Brennerpreisliste

passend für WIG-Stromquellen des Fabrikates „kjellberg“



Brennertyp	Länge	Schalterfunktion	maschinenseitiger Anschluss	Schlauchpaketausführung	Bestellnummer
ABITIG® 18	4 m	EDP	BSB 35-50 Tuchel 7-pol.	Standard	7S4SK046540027A20
	8 m	EDP	BSB 35-50 Tuchel 7-pol.	Standard	7S4SK086540027A20
	4 m	EDP	BSB 35-50 Tuchel 7-pol.	High Flex Leder	7S4SH046540027A20
	8 m	EDP	BSB 35-50 Tuchel 7-pol.	High Flex Leder	7S4SH086540027A20
ABITIG® 18F	4 m	EDP	BSB 35-50 Tuchel 7-pol.	Standard	7S4FK046540027A20
	8 m	EDP	BSB 35-50 Tuchel 7-pol.	Standard	7S4FK086540027A20
	4 m	EDP	BSB 35-50 Tuchel 7-pol.	High Flex Leder	7S4FH046540027A20
	8 m	EDP	BSB 35-50 Tuchel 7-pol.	High Flex Leder	7S4FH086540027A20
ABITIG® 20	4 m	EDP	BSB 35-50 Tuchel 7-pol.	Standard	7S5SK046540027A20
	8 m	EDP	BSB 35-50 Tuchel 7-pol.	Standard	7S5SK086540027A20
	4 m	EDP	BSB 35-50 Tuchel 7-pol.	High Flex Leder	7S5SH046540027A20
	8 m	EDP	BSB 35-50 Tuchel 7-pol.	High Flex Leder	7S5SH086540027A20
ABITIG® 20F	4 m	EDP	BSB 35-50 Tuchel 7-pol.	Standard	7S5FK046540027A20
	8 m	EDP	BSB 35-50 Tuchel 7-pol.	Standard	7S5FK086540027A20
	4 m	EDP	BSB 35-50 Tuchel 7-pol.	High Flex Leder	7S5FH046540027A20
	8 m	EDP	BSB 35-50 Tuchel 7-pol.	High Flex Leder	7S5FH086540027A20

Technische Änderungen vorbehalten • Verkaufspreise = unverbindliche Preisempfehlung - Angebot freibleibend • © Copyright

ABITIG® GRIP / ABITIG® GRIP Little-Brennerpreisliste

passend für WIG-Stromquellen des Fabrikates „kjellberg“

Brennertyp	Länge	Schalterfunktion	maschinenseitiger Anschluss	Schlauchpaketausführung	Bestellnummer
ABITIG® 12-1	4 m	EDP	BSB 35-50 Tuchel 7-pol.	Standard	7S6SK046540027A20
	8 m	EDP	BSB 35-50 Tuchel 7-pol.	Standard	7S6SK086540027A20
	4 m	EDP	BSB 35-50 Tuchel 7-pol.	High Flex Leder	7S6SH046540027A20
	8 m	EDP	BSB 35-50 Tuchel 7-pol.	High Flex Leder	7S6SH086540027A20
<hr/>					
ABITIG® 18SC	4 m	EDP	BSB 35-50 Tuchel 7-pol.	Standard	7S7SK046540027A20
	8 m	EDP	BSB 35-50 Tuchel 7-pol.	Standard	7S7SK086540027A20
	4 m	EDP	BSB 35-50 Tuchel 7-pol.	High Flex Leder	7S7SH046540027A20
	8 m	EDP	BSB 35-50 Tuchel 7-pol.	High Flex Leder	7S7SH086540027A20
<hr/>					
ABITIG® 24W	4 m	EDP	BSB 35-50 Tuchel 7-pol.	Standard	7S9SK046540027A20
	8 m	EDP	BSB 35-50 Tuchel 7-pol.	Standard	7S9SK086540027A20
	4 m	EDP	BSB 35-50 Tuchel 7-pol.	High Flex Leder	7S9SH046540027A20
	8 m	EDP	BSB 35-50 Tuchel 7-pol.	High Flex Leder	7S9SH086540027A20
<hr/>					
ABITIG® 450W	4 m	EDP	BSB 35-50 Tuchel 7-pol.	Standard	7T5SK046540127A20
	8 m	EDP	BSB 35-50 Tuchel 7-pol.	Standard	7T5SK086540127A20
	4 m	EDP	BSB 35-50 Tuchel 7-pol.	High Flex Leder	7T5SH046540127A20
	8 m	EDP	BSB 35-50 Tuchel 7-pol.	High Flex Leder	7T5SH086540127A20
<hr/>					
ABITIG® 260W	4 m	EDP	BSB 35-50 Tuchel 7-pol.	Standard	7T7SK046540127A20
	8 m	EDP	BSB 35-50 Tuchel 7-pol.	Standard	7T7SK086540127A20
	4 m	EDP	BSB 35-50 Tuchel 7-pol.	High Flex Leder	7T7SH046540127A20
	8 m	EDP	BSB 35-50 Tuchel 7-pol.	High Flex Leder	7T7SH086540127A20
<hr/>					
ABITIG® 450W SC	4 m	EDP	BSB 35-50 Tuchel 7-pol.	Standard	
	8 m	EDP	BSB 35-50 Tuchel 7-pol.	Standard	
	4 m	EDP	BSB 35-50 Tuchel 7-pol.	High Flex Leder	7T8SH046540127A20
	8 m	EDP	BSB 35-50 Tuchel 7-pol.	High Flex Leder	7T8SH086540127A20

ABITIG® GRIP / ABITIG® GRIP Little-Brennerpreisliste

passend für WIG-Stromquellen des Fabrikates „kjellberg“

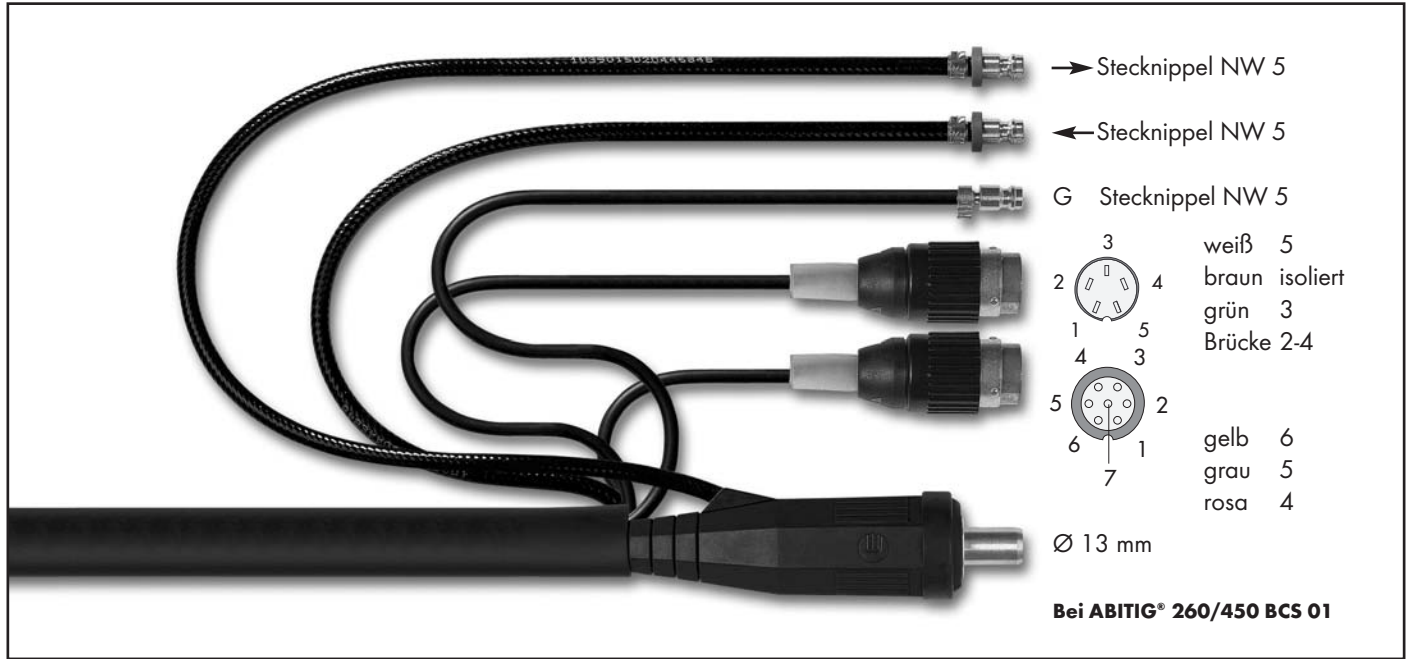

Brennertyp	Länge	Schalterfunktion	maschinenseitiger Anschluss	Schlauchpaketausführung	Bestellnummer
ABITIG® 18	4 m	EDP	BSB 35-50 Tuchel 5-pol./ 7-pol.	Standard	7S4SK046540042B20
	8 m	EDP	BSB 35-50 Tuchel 5-pol./ 7-pol.	Standard	7S4SK086540042B20
	4 m	EDP	BSB 35-50 Tuchel 5-pol./ 7-pol.	High Flex Leder	7S4SH046540042B20
	8 m	EDP	BSB 35-50 Tuchel 5-pol./ 7-pol.	High Flex Leder	7S4SH086540042B20
ABITIG® 18F	4 m	EDP	BSB 35-50 Tuchel 5-pol./ 7-pol.	Standard	7S4FK046540042B20
	8 m	EDP	BSB 35-50 Tuchel 5-pol./ 7-pol.	Standard	7S4FK086540042B20
	4 m	EDP	BSB 35-50 Tuchel 5-pol./ 7-pol.	High Flex Leder	7S4FH046540042B20
	8 m	EDP	BSB 35-50 Tuchel 5-pol./ 7-pol.	High Flex Leder	7S4FH086540042B20
ABITIG® 20	4 m	EDP	BSB 35-50 Tuchel 5-pol./ 7-pol.	Standard	7S5SK046540042B20
	8 m	EDP	BSB 35-50 Tuchel 5-pol./ 7-pol.	Standard	7S5SK086540042B20
	4 m	EDP	BSB 35-50 Tuchel 5-pol./ 7-pol.	High Flex Leder	7S5SH046540042B20
	8 m	EDP	BSB 35-50 Tuchel 5-pol./ 7-pol.	High Flex Leder	7S5SH086540042B20
ABITIG® 20F	4 m	EDP	BSB 35-50 Tuchel 5-pol./ 7-pol.	Standard	7S5FK046540042B20
	8 m	EDP	BSB 35-50 Tuchel 5-pol./ 7-pol.	Standard	7S5FK086540042B20
	4 m	EDP	BSB 35-50 Tuchel 5-pol./ 7-pol.	High Flex Leder	7S5FH046540042B20
	8 m	EDP	BSB 35-50 Tuchel 5-pol./ 7-pol.	High Flex Leder	7S5FH086540042B20

Technische Änderungen vorbehalten • Verkaufspreise = unverbindliche Preisempfehlung - Angebot freibleibend • © Copyright

ABITIG® GRIP / ABITIG® GRIP Little-Brennerpreisliste

passend für WIG-Stromquellen des Fabrikates „kjellberg“

Brennertyp	Länge	Schalterfunktion	maschinenseitiger Anschluss	Schlauchpaketausführung	Bestellnummer
ABITIG® 12-1	4 m	EDP	BSB 35-50 Tuchel 5-pol./ 7-pol.	Standard	7S6SK046540042B20
	8 m	EDP	BSB 35-50 Tuchel 5-pol./ 7-pol.	Standard	7S6SK086540042B20
	4 m	EDP	BSB 35-50 Tuchel 5-pol./ 7-pol.	High Flex Leder	7S6SH046540042B20
	8 m	EDP	BSB 35-50 Tuchel 5-pol./ 7-pol.	High Flex Leder	7S6SH086540042B20
ABITIG® 18SC	4 m	EDP	BSB 35-50 Tuchel 5-pol./ 7-pol.	Standard	7S7SK046540042B20
	8 m	EDP	BSB 35-50 Tuchel 5-pol./ 7-pol.	Standard	7S7SK086540042B20
	4 m	EDP	BSB 35-50 Tuchel 5-pol./ 7-pol.	High Flex Leder	7S7SH046540042B20
	8 m	EDP	BSB 35-50 Tuchel 5-pol./ 7-pol.	High Flex Leder	7S7SH086540042B20
ABITIG® 24W	4 m	EDP	BSB 35-50 Tuchel 5-pol./ 7-pol.	Standard	7S9SK046540042B20
	8 m	EDP	BSB 35-50 Tuchel 5-pol./ 7-pol.	Standard	7S9SK086540042B20
	4 m	EDP	BSB 35-50 Tuchel 5-pol./ 7-pol.	High Flex Leder	7S9SH046540042B20
	8 m	EDP	BSB 35-50 Tuchel 5-pol./ 7-pol.	High Flex Leder	7S9SH086540042B20
ABITIG® 450W	4 m	EDP	BSB 35-50 Tuchel 5-pol./ 7-pol.	Standard	7T5SK046540142B20
	8 m	EDP	BSB 35-50 Tuchel 5-pol./ 7-pol.	Standard	7T5SK086540142B20
	4 m	EDP	BSB 35-50 Tuchel 5-pol./ 7-pol.	High Flex Leder	7T5SH046540142B20
	8 m	EDP	BSB 35-50 Tuchel 5-pol./ 7-pol.	High Flex Leder	7T5SH086540142B20
ABITIG® 260W	4 m	EDP	BSB 35-50 Tuchel 5-pol./ 7-pol.	Standard	7T7SK046540142B20
	8 m	EDP	BSB 35-50 Tuchel 5-pol./ 7-pol.	Standard	7T7SK086540142B20
	4 m	EDP	BSB 35-50 Tuchel 5-pol./ 7-pol.	High Flex Leder	7T7SH046540142B20
	8 m	EDP	BSB 35-50 Tuchel 5-pol./ 7-pol.	High Flex Leder	7T7SH086540142B20
ABITIG® 450W SC	4 m	EDP	BSB 35-50 Tuchel 5-pol./ 7-pol.	Standard	
	8 m	EDP	BSB 35-50 Tuchel 5-pol./ 7-pol.	Standard	
	4 m	EDP	BSB 35-50 Tuchel 5-pol./ 7-pol.	High Flex Leder	7T8SH046540142B20
	8 m	EDP	BSB 35-50 Tuchel 5-pol./ 7-pol.	High Flex Leder	7T8SH086540142B20

ABITIG® GRIP / ABITIG® GRIP Little-Brennerpreisliste

passend für WIG-Stromquellen des Fabrikates „lincoln“

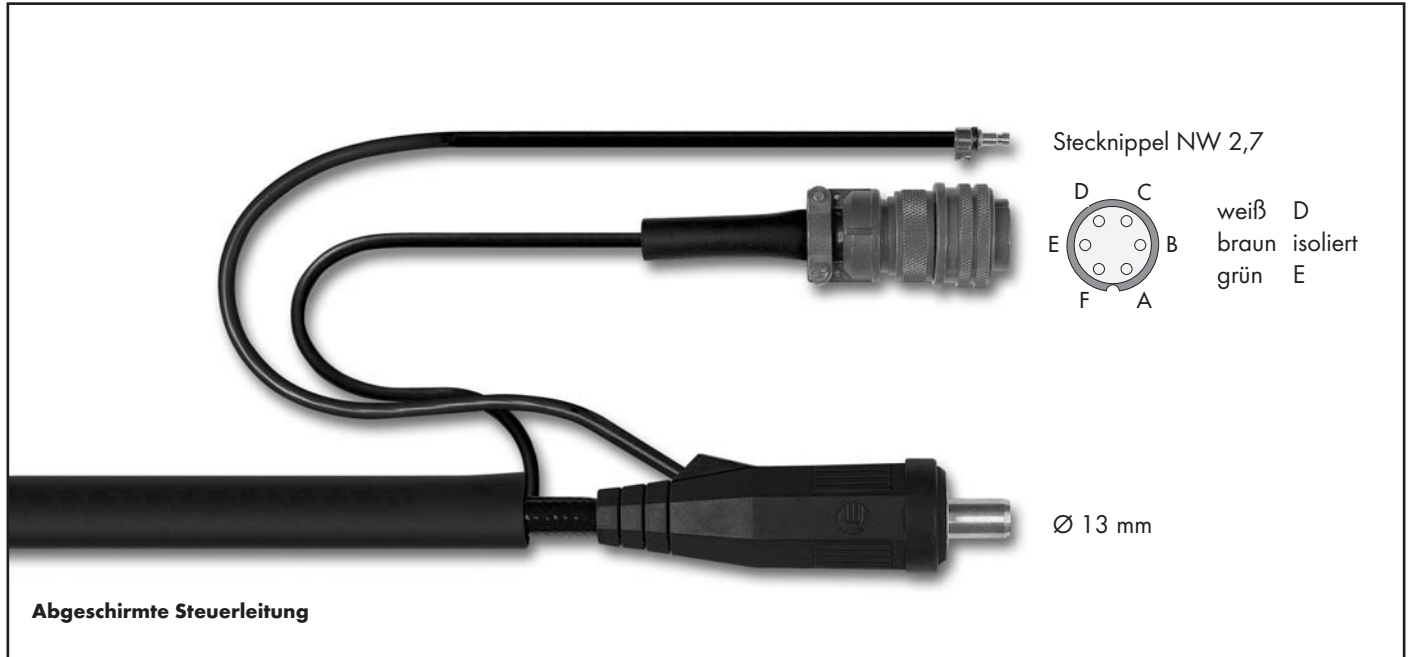

Brennertyp	Länge	Schalterfunktion	maschinenseitiger Anschluss	Schlauchpaketausführung	Bestellnummer
ABITIG® 9	4 m	ED	BSB 35-50 Amphenol 6-pol.	Standard	7S1SK047510038A05
	8 m	ED	BSB 35-50 Amphenol 6-pol.	Standard	7S1SK087510038A05
	4 m	ED	BSB 35-50 Amphenol 6-pol.	High Flex Leder	7S1SH047510038A05
	8 m	ED	BSB 35-50 Amphenol 6-pol.	High Flex Leder	7S1SH087510038A05
ABITIG® 9 Little	4 m	ED	BSB 35-50 Amphenol 6-pol.	High Flex Leder	7L1SH047510038A05
	8 m	ED	BSB 35-50 Amphenol 6-pol.	High Flex Leder	7L1SH087510038A05
ABITIG® 9F	4 m	ED	BSB 35-50 Amphenol 6-pol.	Standard	7S1FK047510038A05
	8 m	ED	BSB 35-50 Amphenol 6-pol.	Standard	7S1FK087510038A05
	4 m	ED	BSB 35-50 Amphenol 6-pol.	High Flex Leder	7S1FH047510038A05
	8 m	ED	BSB 35-50 Amphenol 6-pol.	High Flex Leder	7S1FH087510038A05
ABITIG® 9F Little	4 m	ED	BSB 35-50 Amphenol 6-pol.	High Flex Leder	7L1FH047510038A05
	8 m	ED	BSB 35-50 Amphenol 6-pol.	High Flex Leder	7L1FH087510038A05
ABITIG® 17	4 m	ED	BSB 35-50 Amphenol 6-pol.	Standard	7S2SK047510038A05
	8 m	ED	BSB 35-50 Amphenol 6-pol.	Standard	7S2SK087510038A05
	4 m	ED	BSB 35-50 Amphenol 6-pol.	High Flex Leder	7S2SH047510038A05
	8 m	ED	BSB 35-50 Amphenol 6-pol.	High Flex Leder	7S2SH087510038A05
ABITIG® 17 Little	4 m	ED	BSB 35-50 Amphenol 6-pol.	High Flex Leder	7L2SH047510038A05
	8 m	ED	BSB 35-50 Amphenol 6-pol.	High Flex Leder	7L2SH087510038A05
ABITIG® 17F	4 m	ED	BSB 35-50 Amphenol 6-pol.	Standard	7S2FK047510038A05
	8 m	ED	BSB 35-50 Amphenol 6-pol.	Standard	7S2FK087510038A05
	4 m	ED	BSB 35-50 Amphenol 6-pol.	High Flex Leder	7S2FH047510038A05
	8 m	ED	BSB 35-50 Amphenol 6-pol.	High Flex Leder	7S2FH087510038A05
ABITIG® 17F Little	4 m	ED	BSB 35-50 Amphenol 6-pol.	High Flex Leder	7L2FH047510038A05
	8 m	ED	BSB 35-50 Amphenol 6-pol.	High Flex Leder	7L2FH087510038A05

Technische Änderungen vorbehalten • Verkaufspreise = unverbindliche Preisempfehlung - Angebot freibleibend • © Copyright

ABITIG® GRIP / ABITIG® GRIP Little-Brennerpreisliste

passend für WIG-Stromquellen des Fabrikates „lincoln“

Brennertyp	Länge	Schalterfunktion	maschinenseitiger Anschluss	Schlauchpaketausführung	Bestellnummer
ABITIG® 26	4 m	ED	BSB 35-50 Amphenol 6-pol.	Standard	7S3SK047510038A05
	8 m	ED	BSB 35-50 Amphenol 6-pol.	Standard	7S3SK087510038A05
	4 m	ED	BSB 35-50 Amphenol 6-pol.	High Flex Leder	7S3SH047510038A05
	8 m	ED	BSB 35-50 Amphenol 6-pol.	High Flex Leder	7S3SH087510038A05
ABITIG® 26F	4 m	ED	BSB 35-50 Amphenol 6-pol.	Standard	7S3FK047510038A05
	8 m	ED	BSB 35-50 Amphenol 6-pol.	Standard	7S3FK087510038A05
	4 m	ED	BSB 35-50 Amphenol 6-pol.	High Flex Leder	7S3FH047510038A05
	8 m	ED	BSB 35-50 Amphenol 6-pol.	High Flex Leder	7S3FH087510038A05
ABITIG® 24G	4 m	ED	BSB 35-50 Amphenol 6-pol.	Standard	7S8SK047510038A05
	8 m	ED	BSB 35-50 Amphenol 6-pol.	Standard	7S8SK087510038A05
	4 m	ED	BSB 35-50 Amphenol 6-pol.	High Flex Leder	7S8SH047510038A05
	8 m	ED	BSB 35-50 Amphenol 6-pol.	High Flex Leder	7S8SH087510038A05
ABITIG® 24G Little	4 m	ED	BSB 35-50 Amphenol 6-pol.	High Flex Leder	7L8SH047510038A05
	8 m	ED	BSB 35-50 Amphenol 6-pol.	High Flex Leder	7L8SH087510038A05
ABITIG® 200	4 m	ED	BSB 35-50 Amphenol 6-pol.	Standard	7T4SK047510038A05
	8 m	ED	BSB 35-50 Amphenol 6-pol.	Standard	7T4SK087510038A05
	4 m	ED	BSB 35-50 Amphenol 6-pol.	High Flex Leder	7T4SH047510038A05
	8 m	ED	BSB 35-50 Amphenol 6-pol.	High Flex Leder	7T4SH087510038A05
ABITIG® 200F	4 m	ED	BSB 35-50 Amphenol 6-pol.	Standard	7T4FK047510038A05
	8 m	ED	BSB 35-50 Amphenol 6-pol.	Standard	7T4FK087510038A05
	4 m	ED	BSB 35-50 Amphenol 6-pol.	High Flex Leder	7T4FH047510038A05
	8 m	ED	BSB 35-50 Amphenol 6-pol.	High Flex Leder	7T4FH087510038A05
ABITIG® 150	4 m	ED	BSB 35-50 Amphenol 6-pol.	Standard	7T6SK047510038A05
	8 m	ED	BSB 35-50 Amphenol 6-pol.	Standard	7T6SK087510038A05
	4 m	ED	BSB 35-50 Amphenol 6-pol.	High Flex Leder	7T6SH047510038A05
	8 m	ED	BSB 35-50 Amphenol 6-pol.	High Flex Leder	7T6SH087510038A05
ABITIG® 150 Little	4 m	ED	BSB 35-50 Amphenol 6-pol.	High Flex Leder	7L6SH047510038A05
	8 m	ED	BSB 35-50 Amphenol 6-pol.	High Flex Leder	7L6SH087510038A05
ABITIG® 150F	4 m	ED	BSB 35-50 Amphenol 6-pol.	Standard	7T6FK047510038A05
	8 m	ED	BSB 35-50 Amphenol 6-pol.	Standard	7T6FK087510038A05
	4 m	ED	BSB 35-50 Amphenol 6-pol.	High Flex Leder	7T6FH047510038A05
	8 m	ED	BSB 35-50 Amphenol 6-pol.	High Flex Leder	7T6FH087510038A05
ABITIG® 150F Little	4 m	ED	BSB 35-50 Amphenol 6-pol.	High Flex Leder	7L6FH047510038A05
	8 m	ED	BSB 35-50 Amphenol 6-pol.	High Flex Leder	7L6FH087510038A05

ABITIG® GRIP / ABITIG® GRIP Little-Brennerpreisliste

passend für WIG-Stromquellen des Fabrikates „lincoln“



Brennertyp	Länge	Schalterfunktion	maschinenseitiger Anschluss	Schlauchpaketausführung	Bestellnummer
ABITIG® 9	4 m	ED	BSB 35-50 Tuchel 5-pol.	Standard	7S1SK043510001A05
	8 m	ED	BSB 35-50 Tuchel 5-pol.	Standard	7S1SK083510001A05
	4 m	ED	BSB 35-50 Tuchel 5-pol.	High Flex Leder	7S1SH043510001A05
	8 m	ED	BSB 35-50 Tuchel 5-pol.	High Flex Leder	7S1SH083510001A05
ABITIG® 9 Little	4 m	ED	BSB 35-50 Tuchel 5-pol.	High Flex Leder	7L1SH043510001A05
	8 m	ED	BSB 35-50 Tuchel 5-pol.	High Flex Leder	7L1SH083510001A05
ABITIG® 9F	4 m	ED	BSB 35-50 Tuchel 5-pol.	Standard	7S1FK043510001A05
	8 m	ED	BSB 35-50 Tuchel 5-pol.	Standard	7S1FK083510001A05
	4 m	ED	BSB 35-50 Tuchel 5-pol.	High Flex Leder	7S1FH043510001A05
	8 m	ED	BSB 35-50 Tuchel 5-pol.	High Flex Leder	7S1FH083510001A05
ABITIG® 9F Little	4 m	ED	BSB 35-50 Tuchel 5-pol.	High Flex Leder	7L1FH043510001A05
	8 m	ED	BSB 35-50 Tuchel 5-pol.	High Flex Leder	7L1FH083510001A05
ABITIG® 17	4 m	ED	BSB 35-50 Tuchel 5-pol.	Standard	7S2SK043510001A05
	8 m	ED	BSB 35-50 Tuchel 5-pol.	Standard	7S2SK083510001A05
	4 m	ED	BSB 35-50 Tuchel 5-pol.	High Flex Leder	7S2SH043510001A05
	8 m	ED	BSB 35-50 Tuchel 5-pol.	High Flex Leder	7S2SH083510001A05
ABITIG® 17 Little	4 m	ED	BSB 35-50 Tuchel 5-pol.	High Flex Leder	7L2SH043510001A05
	8 m	ED	BSB 35-50 Tuchel 5-pol.	High Flex Leder	7L2SH083510001A05
ABITIG® 17F	4 m	ED	BSB 35-50 Tuchel 5-pol.	Standard	7S2FK043510001A05
	8 m	ED	BSB 35-50 Tuchel 5-pol.	Standard	7S2FK083510001A05
	4 m	ED	BSB 35-50 Tuchel 5-pol.	High Flex Leder	7S2FH043510001A05
	8 m	ED	BSB 35-50 Tuchel 5-pol.	High Flex Leder	7S2FH083510001A05
ABITIG® 17F Little	4 m	ED	BSB 35-50 Tuchel 5-pol.	High Flex Leder	7L2FH043510001A05
	8 m	ED	BSB 35-50 Tuchel 5-pol.	High Flex Leder	7L2FH083510001A05

Technische Änderungen vorbehalten • Verkaufspreise = unverbindliche Preisempfehlung - Angebot freibleibend • © Copyright

ABITIG® GRIP / ABITIG® GRIP Little-Brennerpreisliste

passend für WIG-Stromquellen des Fabrikates „lincoln“

Brennertyp	Länge	Schalterfunktion	maschinenseitiger Anschluss	Schlauchpaketausführung	Bestellnummer
ABITIG® 26	4 m	ED	BSB 35-50 Tuchel 5-pol.	Standard	7S3SK043510001A05
	8 m	ED	BSB 35-50 Tuchel 5-pol.	Standard	7S3SK083510001A05
	4 m	ED	BSB 35-50 Tuchel 5-pol.	High Flex Leder	7S3SH043510001A05
	8 m	ED	BSB 35-50 Tuchel 5-pol.	High Flex Leder	7S3SH083510001A05
ABITIG® 26F	4 m	ED	BSB 35-50 Tuchel 5-pol.	Standard	7S3FK043510001A05
	8 m	ED	BSB 35-50 Tuchel 5-pol.	Standard	7S3FK083510001A05
	4 m	ED	BSB 35-50 Tuchel 5-pol.	High Flex Leder	7S3FH043510001A05
	8 m	ED	BSB 35-50 Tuchel 5-pol.	High Flex Leder	7S3FH083510001A05
ABITIG® 24G	4 m	ED	BSB 35-50 Tuchel 5-pol.	Standard	7S8SK043510001A05
	8 m	ED	BSB 35-50 Tuchel 5-pol.	Standard	7S8SK083510001A05
	4 m	ED	BSB 35-50 Tuchel 5-pol.	High Flex Leder	7S8SH043510001A05
	8 m	ED	BSB 35-50 Tuchel 5-pol.	High Flex Leder	7S8SH083510001A05
ABITIG® 24G Little	4 m	ED	BSB 35-50 Tuchel 5-pol.	High Flex Leder	7L8SH043510001A05
	8 m	ED	BSB 35-50 Tuchel 5-pol.	High Flex Leder	7L8SH083510001A05
ABITIG® 200	4 m	ED	BSB 35-50 Tuchel 5-pol.	Standard	7T4SK043510001A05
	8 m	ED	BSB 35-50 Tuchel 5-pol.	Standard	7T4SK083510001A05
	4 m	ED	BSB 35-50 Tuchel 5-pol.	High Flex Leder	7T4SH043510001A05
	8 m	ED	BSB 35-50 Tuchel 5-pol.	High Flex Leder	7T4SH083510001A05
ABITIG® 200F	4 m	ED	BSB 35-50 Tuchel 5-pol.	Standard	7T4FK043510001A05
	8 m	ED	BSB 35-50 Tuchel 5-pol.	Standard	7T4FK083510001A05
	4 m	ED	BSB 35-50 Tuchel 5-pol.	High Flex Leder	7T4FH043510001A05
	8 m	ED	BSB 35-50 Tuchel 5-pol.	High Flex Leder	7T4FH083510001A05
ABITIG® 150	4 m	ED	BSB 35-50 Tuchel 5-pol.	Standard	7T6SK043510001A05
	8 m	ED	BSB 35-50 Tuchel 5-pol.	Standard	7T6SK083510001A05
	4 m	ED	BSB 35-50 Tuchel 5-pol.	High Flex Leder	7T6SH043510001A05
	8 m	ED	BSB 35-50 Tuchel 5-pol.	High Flex Leder	7T6SH083510001A05
ABITIG® 150 Little	4 m	ED	BSB 35-50 Tuchel 5-pol.	High Flex Leder	7L6SH043510001A05
	8 m	ED	BSB 35-50 Tuchel 5-pol.	High Flex Leder	7L6SH083510001A05
ABITIG® 150F	4 m	ED	BSB 35-50 Tuchel 5-pol.	Standard	7T6FK043510001A05
	8 m	ED	BSB 35-50 Tuchel 5-pol.	Standard	7T6FK083510001A05
	4 m	ED	BSB 35-50 Tuchel 5-pol.	High Flex Leder	7T6FH043510001A05
	8 m	ED	BSB 35-50 Tuchel 5-pol.	High Flex Leder	7T6FH083510001A05
ABITIG® 150F Little	4 m	ED	BSB 35-50 Tuchel 5-pol.	High Flex Leder	7L6FH043510001A05
	8 m	ED	BSB 35-50 Tuchel 5-pol.	High Flex Leder	7L6FH083510001A05

ABITIG® GRIP / ABITIG® GRIP Little-Brennerpreisliste

passend für WIG-Stromquellen des Fabrikates „lincoln/norweld“



Brennertyp	Länge	Schalterfunktion	maschinenseitiger Anschluss	Schlauchpaketausführung	Bestellnummer
ABITIG® 9	4 m	DD	BSB 35-50 Tuchel 5-pol.	Standard	7S1SK043520001B01
	8 m	DD	BSB 35-50 Tuchel 5-pol.	Standard	7S1SK083520001B01
	4 m	DD	BSB 35-50 Tuchel 5-pol.	High Flex Leder	7S1SH043520001B01
	8 m	DD	BSB 35-50 Tuchel 5-pol.	High Flex Leder	7S1SH083520001B01
ABITIG® 9 Little	4 m	DD	BSB 35-50 Tuchel 5-pol.	High Flex Leder	7L1SH043520001B01
	8 m	DD	BSB 35-50 Tuchel 5-pol.	High Flex Leder	7L1SH083520001B01
ABITIG® 9F	4 m	DD	BSB 35-50 Tuchel 5-pol.	Standard	7S1FK043520001B01
	8 m	DD	BSB 35-50 Tuchel 5-pol.	Standard	7S1FK083520001B01
	4 m	DD	BSB 35-50 Tuchel 5-pol.	High Flex Leder	7S1FH043520001B01
	8 m	DD	BSB 35-50 Tuchel 5-pol.	High Flex Leder	7S1FH083520001B01
ABITIG® 9F Little	4 m	DD	BSB 35-50 Tuchel 5-pol.	High Flex Leder	7L1FH043520001B01
	8 m	DD	BSB 35-50 Tuchel 5-pol.	High Flex Leder	7L1FH083520001B01
ABITIG® 17	4 m	DD	BSB 35-50 Tuchel 5-pol.	Standard	7S2SK043520001B01
	8 m	DD	BSB 35-50 Tuchel 5-pol.	Standard	7S2SK083520001B01
	4 m	DD	BSB 35-50 Tuchel 5-pol.	High Flex Leder	7S2SH043520001B01
	8 m	DD	BSB 35-50 Tuchel 5-pol.	High Flex Leder	7S2SH083520001B01
ABITIG® 17 Little	4 m	DD	BSB 35-50 Tuchel 5-pol.	High Flex Leder	7L2SH043520001B01
	8 m	DD	BSB 35-50 Tuchel 5-pol.	High Flex Leder	7L2SH083520001B01
ABITIG® 17F	4 m	DD	BSB 35-50 Tuchel 5-pol.	Standard	7S2FK043520001B01
	8 m	DD	BSB 35-50 Tuchel 5-pol.	Standard	7S2FK083520001B01
	4 m	DD	BSB 35-50 Tuchel 5-pol.	High Flex Leder	7S2FH043520001B01
	8 m	DD	BSB 35-50 Tuchel 5-pol.	High Flex Leder	7S2FH083520001B01
ABITIG® 17F Little	4 m	DD	BSB 35-50 Tuchel 5-pol.	High Flex Leder	7L2FH043520001B01
	8 m	DD	BSB 35-50 Tuchel 5-pol.	High Flex Leder	7L2FH083520001B01

Technische Änderungen vorbehalten • Verkaufspreise = unverbindliche Preisempfehlung - Angebot freibleibend • © Copyright

ABITIG® GRIP / ABITIG® GRIP Little-Brennerpreisliste

passend für WIG-Stromquellen des Fabrikates „lincoln/norweld“

Brennertyp	Länge	Schalterfunktion	maschinenseitiger Anschluss	Schlauchpaketausführung	Bestellnummer
ABITIG® 26	4 m	DD	BSB 35-50 Tuchel 5-pol.	Standard	7S3SK043520001B01
	8 m	DD	BSB 35-50 Tuchel 5-pol.	Standard	7S3SK083520001B01
	4 m	DD	BSB 35-50 Tuchel 5-pol.	High Flex Leder	7S3SH043520001B01
	8 m	DD	BSB 35-50 Tuchel 5-pol.	High Flex Leder	7S3SH083520001B01
ABITIG® 26F	4 m	DD	BSB 35-50 Tuchel 5-pol.	Standard	7S3FK043520001B01
	8 m	DD	BSB 35-50 Tuchel 5-pol.	Standard	7S3FK083520001B01
	4 m	DD	BSB 35-50 Tuchel 5-pol.	High Flex Leder	7S3FH043520001B01
	8 m	DD	BSB 35-50 Tuchel 5-pol.	High Flex Leder	7S3FH083520001B01
ABITIG® 24G	4 m	DD	BSB 35-50 Tuchel 5-pol.	Standard	7S8SK043520001B01
	8 m	DD	BSB 35-50 Tuchel 5-pol.	Standard	7S8SK083520001B01
	4 m	DD	BSB 35-50 Tuchel 5-pol.	High Flex Leder	7S8SH043520001B01
	8 m	DD	BSB 35-50 Tuchel 5-pol.	High Flex Leder	7S8SH083520001B01
ABITIG® 24G Little	4 m	DD	BSB 35-50 Tuchel 5-pol.	High Flex Leder	7L8SH043520001B01
	8 m	DD	BSB 35-50 Tuchel 5-pol.	High Flex Leder	7L8SH083520001B01
ABITIG® 200	4 m	DD	BSB 35-50 Tuchel 5-pol.	Standard	7T4SK043520001B01
	8 m	DD	BSB 35-50 Tuchel 5-pol.	Standard	7T4SK083520001B01
	4 m	DD	BSB 35-50 Tuchel 5-pol.	High Flex Leder	7T4SH043520001B01
	8 m	DD	BSB 35-50 Tuchel 5-pol.	High Flex Leder	7T4SH083520001B01
ABITIG® 200F	4 m	DD	BSB 35-50 Tuchel 5-pol.	Standard	7T4FK043520001B01
	8 m	DD	BSB 35-50 Tuchel 5-pol.	Standard	7T4FK083520001B01
	4 m	DD	BSB 35-50 Tuchel 5-pol.	High Flex Leder	7T4FH043520001B01
	8 m	DD	BSB 35-50 Tuchel 5-pol.	High Flex Leder	7T4FH083520001B01
ABITIG® 150	4 m	DD	BSB 35-50 Tuchel 5-pol.	Standard	7T6SK043520001B01
	8 m	DD	BSB 35-50 Tuchel 5-pol.	Standard	7T6SK083520001B01
	4 m	DD	BSB 35-50 Tuchel 5-pol.	High Flex Leder	7T6SH043520001B01
	8 m	DD	BSB 35-50 Tuchel 5-pol.	High Flex Leder	7T6SH083520001B01
ABITIG® 150 Little	4 m	DD	BSB 35-50 Tuchel 5-pol.	High Flex Leder	7L6SH043520001B01
	8 m	DD	BSB 35-50 Tuchel 5-pol.	High Flex Leder	7L6SH083520001B01
ABITIG® 150F	4 m	DD	BSB 35-50 Tuchel 5-pol.	Standard	7T6FK043520001B01
	8 m	DD	BSB 35-50 Tuchel 5-pol.	Standard	7T6FK083520001B01
	4 m	DD	BSB 35-50 Tuchel 5-pol.	High Flex Leder	7T6FH043520001B01
	8 m	DD	BSB 35-50 Tuchel 5-pol.	High Flex Leder	7T6FH083520001B01
ABITIG® 150F Little	4 m	DD	BSB 35-50 Tuchel 5-pol.	High Flex Leder	7L6FH043520001B01
	8 m	DD	BSB 35-50 Tuchel 5-pol.	High Flex Leder	7L6FH083520001B01

ABITIG® GRIP / ABITIG® GRIP Little-Brennerpreisliste

passend für WIG-Stromquellen des Fabrikates „lincoln“

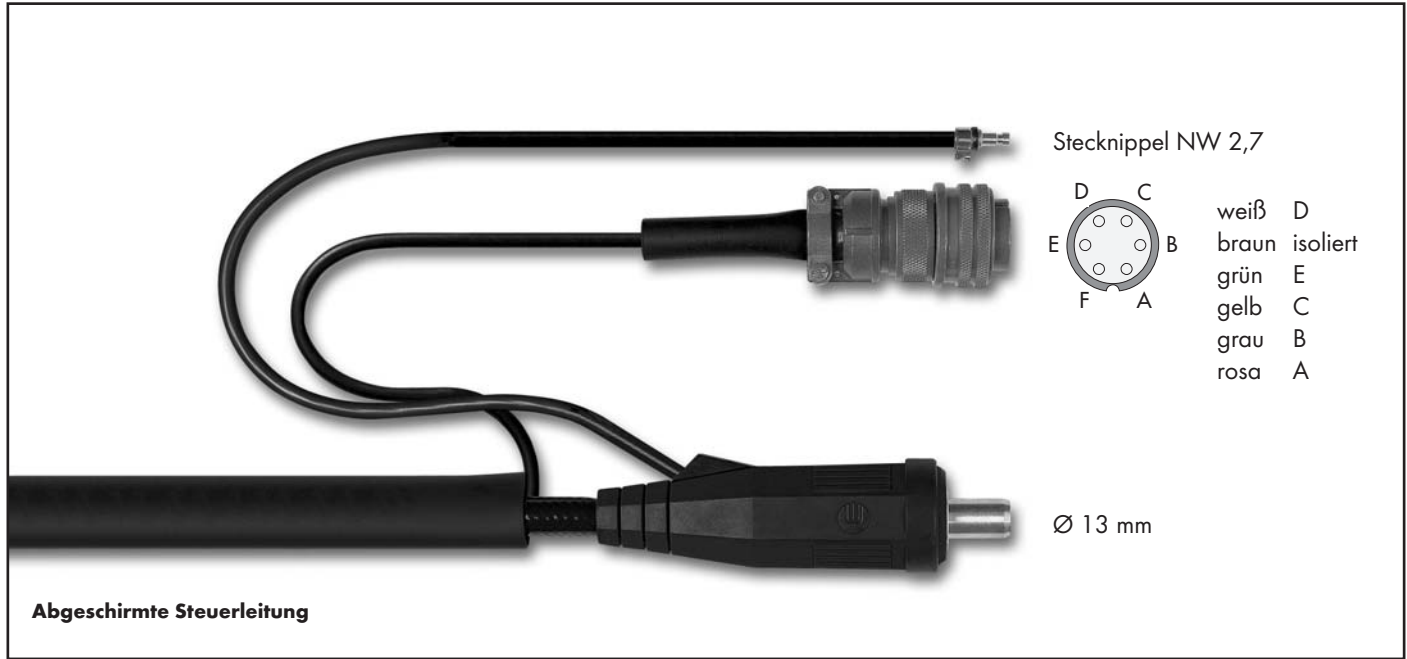

Brennertyp	Länge	Schalterfunktion	maschinenseitiger Anschluss	Schlauchpaketausführung	Bestellnummer
ABITIG® 9	4 m	EDP	BSB 35-50 Amphenol 6-pol.	Standard	7S1SK047540047A05
	8 m	EDP	BSB 35-50 Amphenol 6-pol.	Standard	7S1SK087540047A05
	4 m	EDP	BSB 35-50 Amphenol 6-pol.	High Flex Leder	7S1SH047540047A05
	8 m	EDP	BSB 35-50 Amphenol 6-pol.	High Flex Leder	7S1SH087540047A05
ABITIG® 9F	4 m	EDP	BSB 35-50 Amphenol 6-pol.	Standard	7S1FK047540047A05
	8 m	EDP	BSB 35-50 Amphenol 6-pol.	Standard	7S1FK087540047A05
	4 m	EDP	BSB 35-50 Amphenol 6-pol.	High Flex Leder	7S1FH047540047A05
	8 m	EDP	BSB 35-50 Amphenol 6-pol.	High Flex Leder	7S1FH087540047A05
ABITIG® 17	4 m	EDP	BSB 35-50 Amphenol 6-pol.	Standard	7S2SK047540047A05
	8 m	EDP	BSB 35-50 Amphenol 6-pol.	Standard	7S2SK087540047A05
	4 m	EDP	BSB 35-50 Amphenol 6-pol.	High Flex Leder	7S2SH047540047A05
	8 m	EDP	BSB 35-50 Amphenol 6-pol.	High Flex Leder	7S2SH087540047A05
ABITIG® 17F	4 m	EDP	BSB 35-50 Amphenol 6-pol.	Standard	7S2FK047540047A05
	8 m	EDP	BSB 35-50 Amphenol 6-pol.	Standard	7S2FK087540047A05
	4 m	EDP	BSB 35-50 Amphenol 6-pol.	High Flex Leder	7S2FH047540047A05
	8 m	EDP	BSB 35-50 Amphenol 6-pol.	High Flex Leder	7S2FH087540047A05

Technische Änderungen vorbehalten • Verkaufspreise = unverbindliche Preisempfehlung - Angebot freibleibend • © Copyright

ABITIG® GRIP / ABITIG® GRIP Little-Brennerpreisliste

passend für WIG-Stromquellen des Fabrikates „lincoln“

Brennertyp	Länge	Schalterfunktion	maschinenseitiger Anschluss	Schlauchpaketausführung	Bestellnummer
ABITIG® 26	4 m	EDP	BSB 35-50 Amphenol 6-pol.	Standard	7S3SK047540047A05
	8 m	EDP	BSB 35-50 Amphenol 6-pol.	Standard	7S3SK087540047A05
	4 m	EDP	BSB 35-50 Amphenol 6-pol.	High Flex Leder	7S3SH047540047A05
	8 m	EDP	BSB 35-50 Amphenol 6-pol.	High Flex Leder	7S3SH087540047A05
ABITIG® 26F	4 m	EDP	BSB 35-50 Amphenol 6-pol.	Standard	7S3FK047540047A05
	8 m	EDP	BSB 35-50 Amphenol 6-pol.	Standard	7S3FK087540047A05
	4 m	EDP	BSB 35-50 Amphenol 6-pol.	High Flex Leder	7S3FH047540047A05
	8 m	EDP	BSB 35-50 Amphenol 6-pol.	High Flex Leder	7S3FH087540047A05
ABITIG® 24G	4 m	EDP	BSB 35-50 Amphenol 6-pol.	Standard	7S8SK047540047A05
	8 m	EDP	BSB 35-50 Amphenol 6-pol.	Standard	7S8SK087540047A05
	4 m	EDP	BSB 35-50 Amphenol 6-pol.	High Flex Leder	7S8SH047540047A05
	8 m	EDP	BSB 35-50 Amphenol 6-pol.	High Flex Leder	7S8SH087540047A05
ABITIG® 200	4 m	EDP	BSB 35-50 Amphenol 6-pol.	Standard	7T4SK047540047A05
	8 m	EDP	BSB 35-50 Amphenol 6-pol.	Standard	7T4SK087540047A05
	4 m	EDP	BSB 35-50 Amphenol 6-pol.	High Flex Leder	7T4SH047540047A05
	8 m	EDP	BSB 35-50 Amphenol 6-pol.	High Flex Leder	7T4SH087540047A05
ABITIG® 200F	4 m	EDP	BSB 35-50 Amphenol 6-pol.	Standard	7T4FK047540047A05
	8 m	EDP	BSB 35-50 Amphenol 6-pol.	Standard	7T4FK087540047A05
	4 m	EDP	BSB 35-50 Amphenol 6-pol.	High Flex Leder	7T4FH047540047A05
	8 m	EDP	BSB 35-50 Amphenol 6-pol.	High Flex Leder	7T4FH087540047A05
ABITIG® 150	4 m	EDP	BSB 35-50 Amphenol 6-pol.	Standard	7T6SK047540047A05
	8 m	EDP	BSB 35-50 Amphenol 6-pol.	Standard	7T6SK087540047A05
	4 m	EDP	BSB 35-50 Amphenol 6-pol.	High Flex Leder	7T6SH047540047A05
	8 m	EDP	BSB 35-50 Amphenol 6-pol.	High Flex Leder	7T6SH087540047A05
ABITIG® 150F	4 m	EDP	BSB 35-50 Amphenol 6-pol.	Standard	7T6FK047540047A05
	8 m	EDP	BSB 35-50 Amphenol 6-pol.	Standard	7T6FK087540047A05
	4 m	EDP	BSB 35-50 Amphenol 6-pol.	High Flex Leder	7T6FH047540047A05
	8 m	EDP	BSB 35-50 Amphenol 6-pol.	High Flex Leder	7T6FH087540047A05

ABITIG® GRIP / ABITIG® GRIP Little-Brennerpreisliste

passend für WIG-Stromquellen des Fabrikates „lincoln“

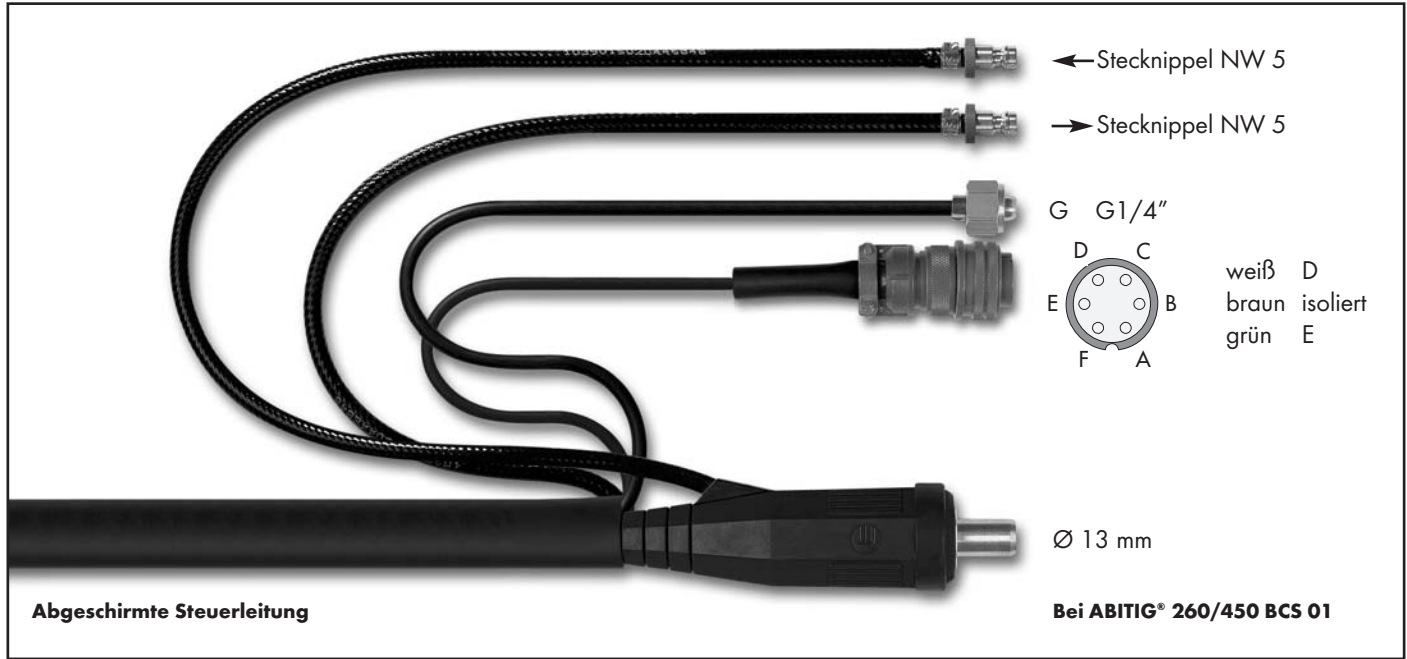

Brennertyp	Länge	Schalterfunktion	maschinenseitiger Anschluss	Schlauchpaketausführung	Bestellnummer
ABITIG® 18	4 m	ED	BSB 35-50 Amphenol 6-pol.	Standard	7S4SK047510038A11
	8 m	ED	BSB 35-50 Amphenol 6-pol.	Standard	7S4SK087510038A11
	4 m	ED	BSB 35-50 Amphenol 6-pol.	High Flex Leder	7S4SH047510038A11
	8 m	ED	BSB 35-50 Amphenol 6-pol.	High Flex Leder	7S4SH087510038A11
ABITIG® 18F	4 m	ED	BSB 35-50 Amphenol 6-pol.	Standard	7S4FK047510038A11
	8 m	ED	BSB 35-50 Amphenol 6-pol.	Standard	7S4FK087510038A11
	4 m	ED	BSB 35-50 Amphenol 6-pol.	High Flex Leder	7S4FH047510038A11
	8 m	ED	BSB 35-50 Amphenol 6-pol.	High Flex Leder	7S4FH087510038A11
ABITIG® 20	4 m	ED	BSB 35-50 Amphenol 6-pol.	Standard	7S5SK047510038A11
	8 m	ED	BSB 35-50 Amphenol 6-pol.	Standard	7S5SK087510038A11
	4 m	ED	BSB 35-50 Amphenol 6-pol.	High Flex Leder	7S5SH047510038A11
	8 m	ED	BSB 35-50 Amphenol 6-pol.	High Flex Leder	7S5SH087510038A11
ABITIG® 20 Little	4 m	ED	BSB 35-50 Amphenol 6-pol.	High Flex Leder	7L5SH047510038A11
	8 m	ED	BSB 35-50 Amphenol 6-pol.	High Flex Leder	7L5SH087510038A11
ABITIG® 20F	4 m	ED	BSB 35-50 Amphenol 6-pol.	Standard	7S5FK047510038A11
	8 m	ED	BSB 35-50 Amphenol 6-pol.	Standard	7S5FK087510038A11
	4 m	ED	BSB 35-50 Amphenol 6-pol.	High Flex Leder	7S5FH047510038A11
	8 m	ED	BSB 35-50 Amphenol 6-pol.	High Flex Leder	7S5FH087510038A11
ABITIG® 20F Little	4 m	ED	BSB 35-50 Amphenol 6-pol.	High Flex Leder	7L5FH047510038A11
	8 m	ED	BSB 35-50 Amphenol 6-pol.	High Flex Leder	7L5FH087510038A11

Technische Änderungen vorbehalten • Verkaufspreise = unverbindliche Preisempfehlung - Angebot freibleibend • © Copyright

ABITIG® GRIP / ABITIG® GRIP Little-Brennerpreisliste

passend für WIG-Stromquellen des Fabrikates „lincoln“

Brennertyp	Länge	Schalterfunktion	maschinenseitiger Anschluss	Schlauchpaketausführung	Bestellnummer
ABITIG® 12-1	4 m	ED	BSB 35-50 Amphenol 6-pol.	Standard	7S6SK047510038A11
	8 m	ED	BSB 35-50 Amphenol 6-pol.	Standard	7S6SK087510038A11
	4 m	ED	BSB 35-50 Amphenol 6-pol.	High Flex Leder	7S6SH047510038A11
	8 m	ED	BSB 35-50 Amphenol 6-pol.	High Flex Leder	7S6SH087510038A11
ABITIG® 18SC	4 m	ED	BSB 35-50 Amphenol 6-pol.	Standard	7S7SK047510038A11
	8 m	ED	BSB 35-50 Amphenol 6-pol.	Standard	7S7SK087510038A11
	4 m	ED	BSB 35-50 Amphenol 6-pol.	High Flex Leder	7S7SH047510038A11
	8 m	ED	BSB 35-50 Amphenol 6-pol.	High Flex Leder	7S7SH087510038A11
ABITIG® 24W	4 m	ED	BSB 35-50 Amphenol 6-pol.	Standard	7S9SK047510038A11
	8 m	ED	BSB 35-50 Amphenol 6-pol.	Standard	7S9SK087510038A11
	4 m	ED	BSB 35-50 Amphenol 6-pol.	High Flex Leder	7S9SH047510038A11
	8 m	ED	BSB 35-50 Amphenol 6-pol.	High Flex Leder	7S9SH087510038A11
ABITIG® 24W Little	4 m	ED	BSB 35-50 Amphenol 6-pol.	High Flex Leder	7L9SH047510038A11
	8 m	ED	BSB 35-50 Amphenol 6-pol.	High Flex Leder	7L9SH087510038A11
ABITIG® 450W	4 m	ED	BSB 35-50 Amphenol 6-pol.	Standard	7T5SK047510138A11
	8 m	ED	BSB 35-50 Amphenol 6-pol.	Standard	7T5SK087510138A11
	4 m	ED	BSB 35-50 Amphenol 6-pol.	High Flex Leder	7T5SH047510138A11
	8 m	ED	BSB 35-50 Amphenol 6-pol.	High Flex Leder	7T5SH087510138A11
ABITIG® 260W	4 m	ED	BSB 35-50 Amphenol 6-pol.	Standard	7T7SK047510138A11
	8 m	ED	BSB 35-50 Amphenol 6-pol.	Standard	7T7SK087510138A11
	4 m	ED	BSB 35-50 Amphenol 6-pol.	High Flex Leder	7T7SH047510138A11
	8 m	ED	BSB 35-50 Amphenol 6-pol.	High Flex Leder	7T7SH087510138A11
ABITIG® 260W Little	4 m	ED	BSB 35-50 Amphenol 6-pol.	High Flex Leder	7L7SH047510138A11
	8 m	ED	BSB 35-50 Amphenol 6-pol.	High Flex Leder	7L7SH087510138A11
ABITIG® 450W SC	4 m	ED	BSB 35-50 Amphenol 6-pol.	Standard	
	8 m	ED	BSB 35-50 Amphenol 6-pol.	Standard	
	4 m	ED	BSB 35-50 Amphenol 6-pol.	High Flex Leder	7T8SH047510138A11
	8 m	ED	BSB 35-50 Amphenol 6-pol.	High Flex Leder	7T8SH087510138A11

ABITIG® GRIP / ABITIG® GRIP Little-Brennerpreisliste

passend für WIG-Stromquellen des Fabrikates „lincoln“

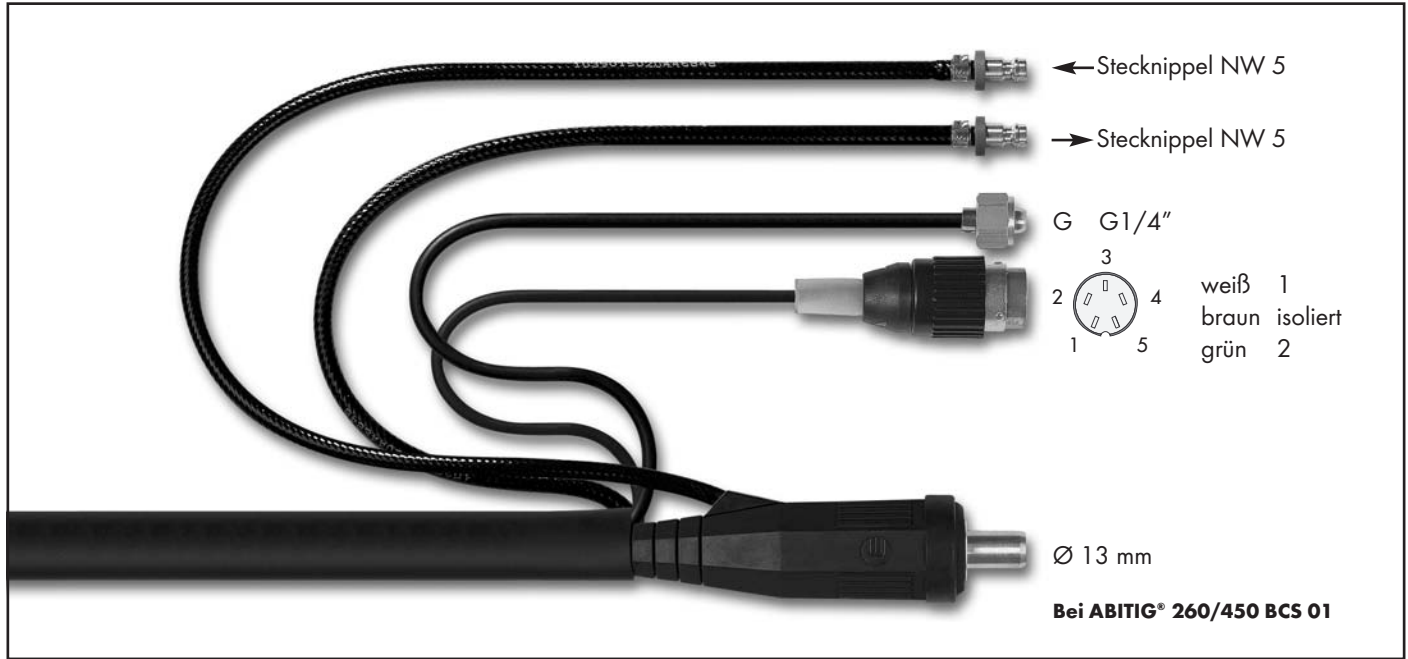

Brennertyp	Länge	Schalterfunktion	maschinenseitiger Anschluss	Schlauchpaketausführung	Bestellnummer
ABITIG® 18	4 m	ED	BSB 35-50 Tuchel 5-pol.	Standard	7S4SK043510001A11
	8 m	ED	BSB 35-50 Tuchel 5-pol.	Standard	7S4SK083510001A11
	4 m	ED	BSB 35-50 Tuchel 5-pol.	High Flex Leder	7S4SH043510001A11
	8 m	ED	BSB 35-50 Tuchel 5-pol.	High Flex Leder	7S4SH083510001A11
ABITIG® 18F	4 m	ED	BSB 35-50 Tuchel 5-pol.	Standard	7S4FK043510001A11
	8 m	ED	BSB 35-50 Tuchel 5-pol.	Standard	7S4FK083510001A11
	4 m	ED	BSB 35-50 Tuchel 5-pol.	High Flex Leder	7S4FH043510001A11
	8 m	ED	BSB 35-50 Tuchel 5-pol.	High Flex Leder	7S4FH083510001A11
ABITIG® 20	4 m	ED	BSB 35-50 Tuchel 5-pol.	Standard	7S5SK043510001A11
	8 m	ED	BSB 35-50 Tuchel 5-pol.	Standard	7S5SK083510001A11
	4 m	ED	BSB 35-50 Tuchel 5-pol.	High Flex Leder	7S5SH043510001A11
	8 m	ED	BSB 35-50 Tuchel 5-pol.	High Flex Leder	7S5SH083510001A11
ABITIG® 20 Little	4 m	ED	BSB 35-50 Tuchel 5-pol.	High Flex Leder	7L5SH043510001A11
	8 m	ED	BSB 35-50 Tuchel 5-pol.	High Flex Leder	7L5SH083510001A11
ABITIG® 20F	4 m	ED	BSB 35-50 Tuchel 5-pol.	Standard	7S5FK043510001A11
	8 m	ED	BSB 35-50 Tuchel 5-pol.	Standard	7S5FK083510001A11
	4 m	ED	BSB 35-50 Tuchel 5-pol.	High Flex Leder	7S5FH043510001A11
	8 m	ED	BSB 35-50 Tuchel 5-pol.	High Flex Leder	7S5FH083510001A11
ABITIG® 20F Little	4 m	ED	BSB 35-50 Tuchel 5-pol.	High Flex Leder	7L5FH043510001A11
	8 m	ED	BSB 35-50 Tuchel 5-pol.	High Flex Leder	7L5FH083510001A11

Technische Änderungen vorbehalten • Verkaufspreise = unverbindliche Preisempfehlung - Angebot freibleibend • © Copyright

ABITIG® GRIP / ABITIG® GRIP Little-Brennerpreisliste

passend für WIG-Stromquellen des Fabrikates „lincoln“

Brennertyp	Länge	Schalterfunktion	maschinenseitiger Anschluss	Schlauchpaketausführung	Bestellnummer
ABITIG® 12-1	4 m	ED	BSB 35-50 Tuchel 5-pol.	Standard	7S6SK043510001A11
	8 m	ED	BSB 35-50 Tuchel 5-pol.	Standard	7S6SK083510001A11
	4 m	ED	BSB 35-50 Tuchel 5-pol.	High Flex Leder	7S6SH043510001A11
	8 m	ED	BSB 35-50 Tuchel 5-pol.	High Flex Leder	7S6SH083510001A11
ABITIG® 18SC	4 m	ED	BSB 35-50 Tuchel 5-pol.	Standard	7S7SK043510001A11
	8 m	ED	BSB 35-50 Tuchel 5-pol.	Standard	7S7SK083510001A11
	4 m	ED	BSB 35-50 Tuchel 5-pol.	High Flex Leder	7S7SH043510001A11
	8 m	ED	BSB 35-50 Tuchel 5-pol.	High Flex Leder	7S7SH083510001A11
ABITIG® 24W	4 m	ED	BSB 35-50 Tuchel 5-pol.	Standard	7S9SK043510001A11
	8 m	ED	BSB 35-50 Tuchel 5-pol.	Standard	7S9SK083510001A11
	4 m	ED	BSB 35-50 Tuchel 5-pol.	High Flex Leder	7S9SH043510001A11
	8 m	ED	BSB 35-50 Tuchel 5-pol.	High Flex Leder	7S9SH083510001A11
ABITIG® 24W Little	4 m	ED	BSB 35-50 Tuchel 5-pol.	High Flex Leder	7L9SH043510001A11
	8 m	ED	BSB 35-50 Tuchel 5-pol.	High Flex Leder	7L9SH083510001A11
ABITIG® 450W	4 m	ED	BSB 35-50 Tuchel 5-pol.	Standard	7T5SK043510101A11
	8 m	ED	BSB 35-50 Tuchel 5-pol.	Standard	7T5SK083510101A11
	4 m	ED	BSB 35-50 Tuchel 5-pol.	High Flex Leder	7T5SH043510101A11
	8 m	ED	BSB 35-50 Tuchel 5-pol.	High Flex Leder	7T5SH083510101A11
ABITIG® 260W	4 m	ED	BSB 35-50 Tuchel 5-pol.	Standard	7T7SK043510101A11
	8 m	ED	BSB 35-50 Tuchel 5-pol.	Standard	7T7SK083510101A11
	4 m	ED	BSB 35-50 Tuchel 5-pol.	High Flex Leder	7T7SH043510101A11
	8 m	ED	BSB 35-50 Tuchel 5-pol.	High Flex Leder	7T7SH083510101A11
ABITIG® 260W Little	4 m	ED	BSB 35-50 Tuchel 5-pol.	High Flex Leder	7L7SH043510101A11
	8 m	ED	BSB 35-50 Tuchel 5-pol.	High Flex Leder	7L7SH083510101A11
ABITIG® 450W SC	4 m	ED	BSB 35-50 Tuchel 5-pol.	Standard	
	8 m	ED	BSB 35-50 Tuchel 5-pol.	Standard	
	4 m	ED	BSB 35-50 Tuchel 5-pol.	High Flex Leder	7T8SH043510101A11
	8 m	ED	BSB 35-50 Tuchel 5-pol.	High Flex Leder	7T8SH083510101A11

ABITIG® GRIP / ABITIG® GRIP Little-Brennerpreisliste

passend für WIG-Stromquellen des Fabrikates „lincoln“

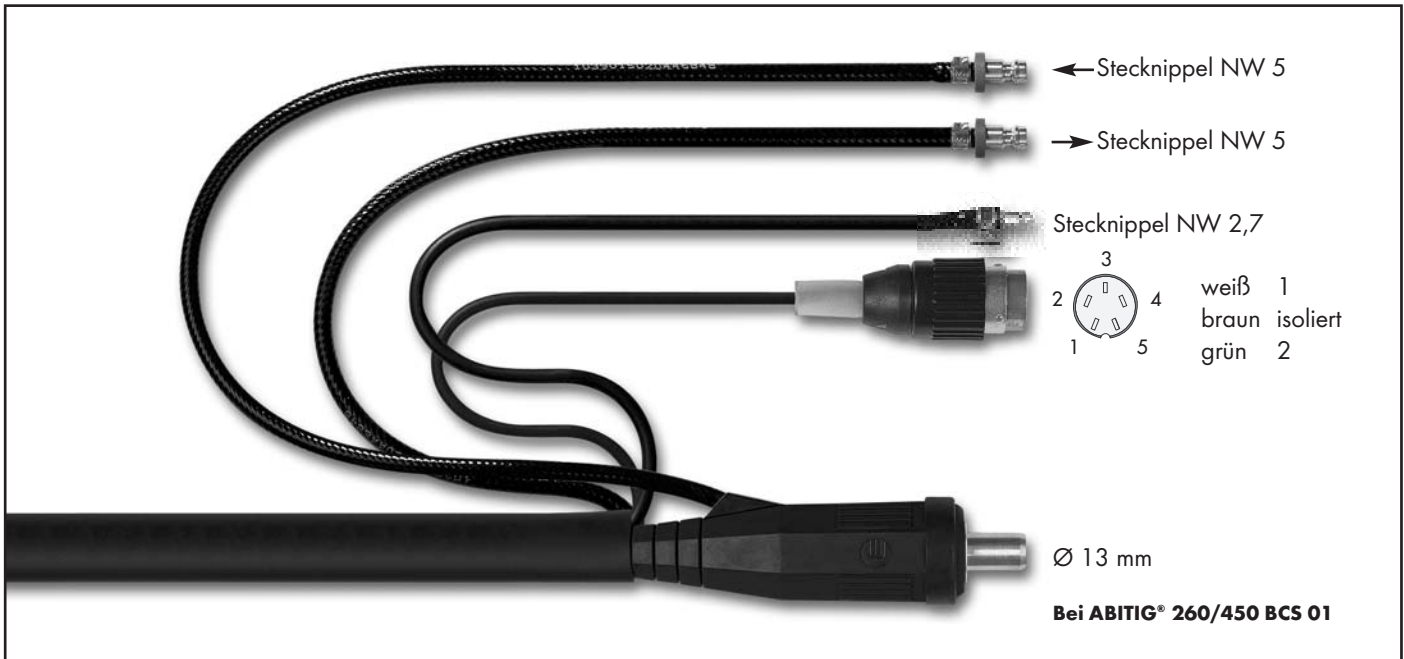

Brennertyp	Länge	Schalterfunktion	maschinenseitiger Anschluss	Schlauchpaketausführung	Bestellnummer
ABITIG® 18	4 m	ED	BSB 35-50 Tuchel 5-pol.	Standard	7S4SK043510001A16
	8 m	ED	BSB 35-50 Tuchel 5-pol.	Standard	7S4SK083510001A16
	4 m	ED	BSB 35-50 Tuchel 5-pol.	High Flex Leder	7S4SH043510001A16
	8 m	ED	BSB 35-50 Tuchel 5-pol.	High Flex Leder	7S4SH083510001A16
ABITIG® 18F	4 m	ED	BSB 35-50 Tuchel 5-pol.	Standard	7S4FK043510001A16
	8 m	ED	BSB 35-50 Tuchel 5-pol.	Standard	7S4FK083510001A16
	4 m	ED	BSB 35-50 Tuchel 5-pol.	High Flex Leder	7S4FH043510001A16
	8 m	ED	BSB 35-50 Tuchel 5-pol.	High Flex Leder	7S4FH083510001A16
ABITIG® 20	4 m	ED	BSB 35-50 Tuchel 5-pol.	Standard	7S5SK043510001A16
	8 m	ED	BSB 35-50 Tuchel 5-pol.	Standard	7S5SK083510001A16
	4 m	ED	BSB 35-50 Tuchel 5-pol.	High Flex Leder	7S5SH043510001A16
	8 m	ED	BSB 35-50 Tuchel 5-pol.	High Flex Leder	7S5SH083510001A16
ABITIG® 20 Little	4 m	ED	BSB 35-50 Tuchel 5-pol.	High Flex Leder	7L5SH043510001A16
	8 m	ED	BSB 35-50 Tuchel 5-pol.	High Flex Leder	7L5SH083510001A16
ABITIG® 20F	4 m	ED	BSB 35-50 Tuchel 5-pol.	Standard	7S5FK043510001A16
	8 m	ED	BSB 35-50 Tuchel 5-pol.	Standard	7S5FK083510001A16
	4 m	ED	BSB 35-50 Tuchel 5-pol.	High Flex Leder	7S5FH043510001A16
	8 m	ED	BSB 35-50 Tuchel 5-pol.	High Flex Leder	7S5FH083510001A16
ABITIG® 20F Little	4 m	ED	BSB 35-50 Tuchel 5-pol.	High Flex Leder	7L5FH043510001A16
	8 m	ED	BSB 35-50 Tuchel 5-pol.	High Flex Leder	7L5FH083510001A16

Technische Änderungen vorbehalten • Verkaufspreise = unverbindliche Preisempfehlung - Angebot freibleibend • © Copyright

ABITIG® GRIP / ABITIG® GRIP Little-Brennerpreisliste

passend für WIG-Stromquellen des Fabrikates „lincoln“

Brennertyp	Länge	Schalterfunktion	maschinenseitiger Anschluss	Schlauchpaketausführung	Bestellnummer
ABITIG® 12-1	4 m	ED	BSB 35-50 Tuchel 5-pol.	Standard	7S6SK043510001A16
	8 m	ED	BSB 35-50 Tuchel 5-pol.	Standard	7S6SK083510001A16
	4 m	ED	BSB 35-50 Tuchel 5-pol.	High Flex Leder	7S6SH043510001A16
	8 m	ED	BSB 35-50 Tuchel 5-pol.	High Flex Leder	7S6SH083510001A16
ABITIG® 18SC	4 m	ED	BSB 35-50 Tuchel 5-pol.	Standard	7S7SK043510001A16
	8 m	ED	BSB 35-50 Tuchel 5-pol.	Standard	7S7SK083510001A16
	4 m	ED	BSB 35-50 Tuchel 5-pol.	High Flex Leder	7S7SH043510001A16
	8 m	ED	BSB 35-50 Tuchel 5-pol.	High Flex Leder	7S7SH083510001A16
ABITIG® 24W	4 m	ED	BSB 35-50 Tuchel 5-pol.	Standard	7S9SK043510001A16
	8 m	ED	BSB 35-50 Tuchel 5-pol.	Standard	7S9SK083510001A16
	4 m	ED	BSB 35-50 Tuchel 5-pol.	High Flex Leder	7S9SH043510001A16
	8 m	ED	BSB 35-50 Tuchel 5-pol.	High Flex Leder	7S9SH083510001A16
ABITIG® 24W Little	4 m	ED	BSB 35-50 Tuchel 5-pol.	High Flex Leder	7L9SH043510001A16
	8 m	ED	BSB 35-50 Tuchel 5-pol.	High Flex Leder	7L9SH083510001A16
ABITIG® 450W	4 m	ED	BSB 35-50 Tuchel 5-pol.	Standard	7T5SK043510101A16
	8 m	ED	BSB 35-50 Tuchel 5-pol.	Standard	7T5SK083510101A16
	4 m	ED	BSB 35-50 Tuchel 5-pol.	High Flex Leder	7T5SH043510101A16
	8 m	ED	BSB 35-50 Tuchel 5-pol.	High Flex Leder	7T5SH083510101A16
ABITIG® 260W	4 m	ED	BSB 35-50 Tuchel 5-pol.	Standard	7T7SK043510101A16
	8 m	ED	BSB 35-50 Tuchel 5-pol.	Standard	7T7SK083510101A16
	4 m	ED	BSB 35-50 Tuchel 5-pol.	High Flex Leder	7T7SH043510101A16
	8 m	ED	BSB 35-50 Tuchel 5-pol.	High Flex Leder	7T7SH083510101A16
ABITIG® 260W Little	4 m	ED	BSB 35-50 Tuchel 5-pol.	High Flex Leder	7L7SH043510101A16
	8 m	ED	BSB 35-50 Tuchel 5-pol.	High Flex Leder	7L7SH083510101A16
ABITIG® 450W SC	4 m	ED	BSB 35-50 Tuchel 5-pol.	Standard	
	8 m	ED	BSB 35-50 Tuchel 5-pol.	Standard	
	4 m	ED	BSB 35-50 Tuchel 5-pol.	High Flex Leder	7T8SH043510101A16
	8 m	ED	BSB 35-50 Tuchel 5-pol.	High Flex Leder	7T8SH083510101A16

ABITIG® GRIP / ABITIG® GRIP Little-Brennerpreisliste

passend für WIG-Stromquellen des Fabrikates „lincoln“

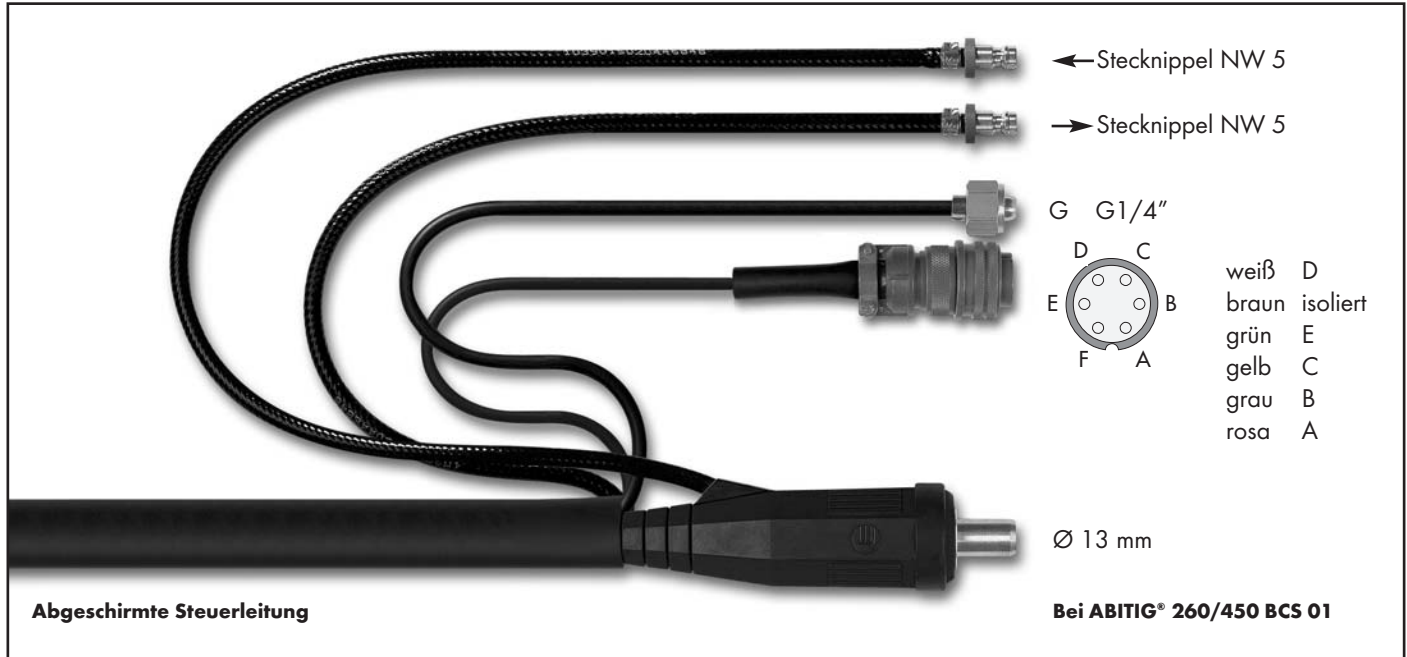

Brennertyp	Länge	Schalterfunktion	maschinenseitiger Anschluss	Schlauchpaketausführung	Bestellnummer
ABITIG® 18	4 m	EDP	BSB 35-50 Amphenol 6-pol.	Standard	7S4SK047510047A11
	8 m	EDP	BSB 35-50 Amphenol 6-pol.	Standard	7S4SK087510047A11
	4 m	EDP	BSB 35-50 Amphenol 6-pol.	High Flex Leder	7S4SH047510047A11
	8 m	EDP	BSB 35-50 Amphenol 6-pol.	High Flex Leder	7S4SH087510047A11
ABITIG® 18F	4 m	EDP	BSB 35-50 Amphenol 6-pol.	Standard	7S4FK047510047A11
	8 m	EDP	BSB 35-50 Amphenol 6-pol.	Standard	7S4FK087510047A11
	4 m	EDP	BSB 35-50 Amphenol 6-pol.	High Flex Leder	7S4FH047510047A11
	8 m	EDP	BSB 35-50 Amphenol 6-pol.	High Flex Leder	7S4FH087510047A11
ABITIG® 20	4 m	EDP	BSB 35-50 Amphenol 6-pol.	Standard	7S5SK047510047A11
	8 m	EDP	BSB 35-50 Amphenol 6-pol.	Standard	7S5SK087510047A11
	4 m	EDP	BSB 35-50 Amphenol 6-pol.	High Flex Leder	7S5SH047510047A11
	8 m	EDP	BSB 35-50 Amphenol 6-pol.	High Flex Leder	7S5SH087510047A11
ABITIG® 20F	4 m	EDP	BSB 35-50 Amphenol 6-pol.	Standard	7S5FK047510047A11
	8 m	EDP	BSB 35-50 Amphenol 6-pol.	Standard	7S5FK087510047A11
	4 m	EDP	BSB 35-50 Amphenol 6-pol.	High Flex Leder	7S5FH047510047A11
	8 m	EDP	BSB 35-50 Amphenol 6-pol.	High Flex Leder	7S5FH087510047A11

Technische Änderungen vorbehalten • Verkaufspreise = unverbindliche Preisempfehlung - Angebot freibleibend • © Copyright

ABITIG® GRIP / ABITIG® GRIP Little-Brennerpreisliste

passend für WIG-Stromquellen des Fabrikates „lincoln“

Brennertyp	Länge	Schalterfunktion	maschinenseitiger Anschluss	Schlauchpaketausführung	Bestellnummer
ABITIG® 12-1	4 m	EDP	BSB 35-50 Amphenol 6-pol.	Standard	7S6SK047510047A11
	8 m	EDP	BSB 35-50 Amphenol 6-pol.	Standard	7S6SK087510047A11
	4 m	EDP	BSB 35-50 Amphenol 6-pol.	High Flex Leder	7S6SH047510047A11
	8 m	EDP	BSB 35-50 Amphenol 6-pol.	High Flex Leder	7S6SH087510047A11
ABITIG® 18SC	4 m	EDP	BSB 35-50 Amphenol 6-pol.	Standard	7S7SK047510047A11
	8 m	EDP	BSB 35-50 Amphenol 6-pol.	Standard	7S7SK087510047A11
	4 m	EDP	BSB 35-50 Amphenol 6-pol.	High Flex Leder	7S7SH047510047A11
	8 m	EDP	BSB 35-50 Amphenol 6-pol.	High Flex Leder	7S7SH087510047A11
ABITIG® 24W	4 m	EDP	BSB 35-50 Amphenol 6-pol.	Standard	7S9SK047510047A11
	8 m	EDP	BSB 35-50 Amphenol 6-pol.	Standard	7S9SK087510047A11
	4 m	EDP	BSB 35-50 Amphenol 6-pol.	High Flex Leder	7S9SH047510047A11
	8 m	EDP	BSB 35-50 Amphenol 6-pol.	High Flex Leder	7S9SH087510047A11
ABITIG® 450W	4 m	EDP	BSB 35-50 Amphenol 6-pol.	Standard	7T5SK047510147A11
	8 m	EDP	BSB 35-50 Amphenol 6-pol.	Standard	7T5SK087510147A11
	4 m	EDP	BSB 35-50 Amphenol 6-pol.	High Flex Leder	7T5SH047510147A11
	8 m	EDP	BSB 35-50 Amphenol 6-pol.	High Flex Leder	7T5SH087510147A11
ABITIG® 260W	4 m	EDP	BSB 35-50 Amphenol 6-pol.	Standard	7T7SK047510147A11
	8 m	EDP	BSB 35-50 Amphenol 6-pol.	Standard	7T7SK087510147A11
	4 m	EDP	BSB 35-50 Amphenol 6-pol.	High Flex Leder	7T7SH047510147A11
	8 m	EDP	BSB 35-50 Amphenol 6-pol.	High Flex Leder	7T7SH087510147A11
ABITIG® 450W SC	4 m	EDP	BSB 35-50 Amphenol 6-pol.	Standard	
	8 m	EDP	BSB 35-50 Amphenol 6-pol.	Standard	
	4 m	EDP	BSB 35-50 Amphenol 6-pol.	High Flex Leder	7T8SH047510147A11
	8 m	EDP	BSB 35-50 Amphenol 6-pol.	High Flex Leder	7T8SH087510147A11

ABITIG® GRIP / ABITIG® GRIP Little-Brennerpreisliste

passend für WIG-Stromquellen des Fabrikates „lincoln/norweld“

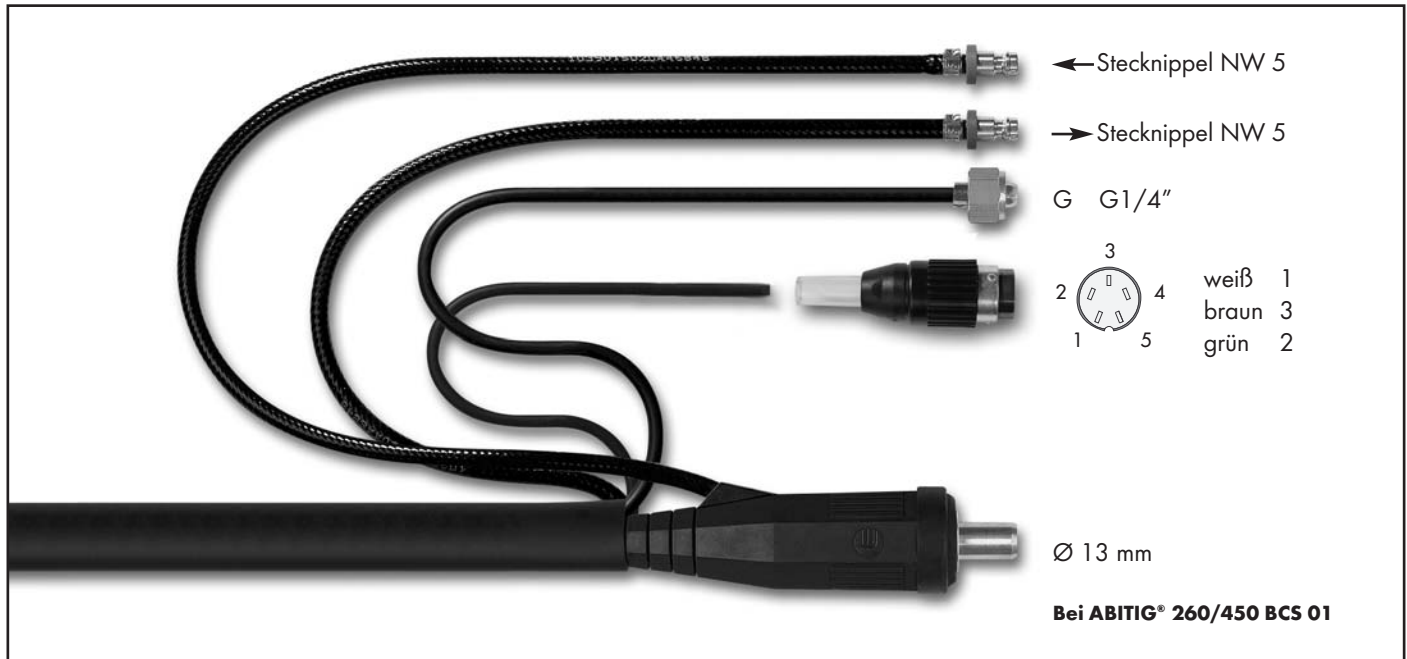

Brennertyp	Länge	Schalterfunktion	maschinenseitiger Anschluss	Schlauchpaketausführung	Bestellnummer
ABITIG® 18	4 m	DD	BSB 35-50 Tuchel 5-pol.	Standard	7S4SK043520001B11
	8 m	DD	BSB 35-50 Tuchel 5-pol.	Standard	7S4SK083520001B11
	4 m	DD	BSB 35-50 Tuchel 5-pol.	High Flex Leder	7S4SH043520001B11
	8 m	DD	BSB 35-50 Tuchel 5-pol.	High Flex Leder	7S4SH083520001B11
ABITIG® 18F	4 m	DD	BSB 35-50 Tuchel 5-pol.	Standard	7S4FK043520001B11
	8 m	DD	BSB 35-50 Tuchel 5-pol.	Standard	7S4FK083520001B11
	4 m	DD	BSB 35-50 Tuchel 5-pol.	High Flex Leder	7S4FH043520001B11
	8 m	DD	BSB 35-50 Tuchel 5-pol.	High Flex Leder	7S4FH083520001B11
ABITIG® 20	4 m	DD	BSB 35-50 Tuchel 5-pol.	Standard	7S5SK043520001B11
	8 m	DD	BSB 35-50 Tuchel 5-pol.	Standard	7S5SK083520001B11
	4 m	DD	BSB 35-50 Tuchel 5-pol.	High Flex Leder	7S5SH043520001B11
	8 m	DD	BSB 35-50 Tuchel 5-pol.	High Flex Leder	7S5SH083520001B11
ABITIG® 20 Little	4 m	DD	BSB 35-50 Tuchel 5-pol.	High Flex Leder	7L5SH043520001B11
	8 m	DD	BSB 35-50 Tuchel 5-pol.	High Flex Leder	7L5SH083520001B11
ABITIG® 20F	4 m	DD	BSB 35-50 Tuchel 5-pol.	Standard	7S5FK043520001B11
	8 m	DD	BSB 35-50 Tuchel 5-pol.	Standard	7S5FK083520001B11
	4 m	DD	BSB 35-50 Tuchel 5-pol.	High Flex Leder	7S5FH043520001B11
	8 m	DD	BSB 35-50 Tuchel 5-pol.	High Flex Leder	7S5FH083520001B11
ABITIG® 20F Little	4 m	DD	BSB 35-50 Tuchel 5-pol.	High Flex Leder	7L5FH043520001B11
	8 m	DD	BSB 35-50 Tuchel 5-pol.	High Flex Leder	7L5FH083520001B11

Technische Änderungen vorbehalten • Verkaufspreise = unverbindliche Preisempfehlung - Angebot freibleibend • © Copyright

ABITIG® GRIP / ABITIG® GRIP Little-Brennerpreisliste

passend für WIG-Stromquellen des Fabrikates „lincoln/norweld“

Brennertyp	Länge	Schalterfunktion	maschinenseitiger Anschluss	Schlauchpaketausführung	Bestellnummer
ABITIG® 12-1	4 m	DD	BSB 35-50 Tuchel 5-pol.	Standard	7S6SK043520001B11
	8 m	DD	BSB 35-50 Tuchel 5-pol.	Standard	7S6SK083520001B11
	4 m	DD	BSB 35-50 Tuchel 5-pol.	High Flex Leder	7S6SH043520001B11
	8 m	DD	BSB 35-50 Tuchel 5-pol.	High Flex Leder	7S6SH083520001B11
<hr/>					
ABITIG® 18SC	4 m	DD	BSB 35-50 Tuchel 5-pol.	Standard	7S7SK043520001B11
	8 m	DD	BSB 35-50 Tuchel 5-pol.	Standard	7S7SK083520001B11
	4 m	DD	BSB 35-50 Tuchel 5-pol.	High Flex Leder	7S7SH043520001B11
	8 m	DD	BSB 35-50 Tuchel 5-pol.	High Flex Leder	7S7SH083520001B11
<hr/>					
ABITIG® 24W	4 m	DD	BSB 35-50 Tuchel 5-pol.	Standard	7S9SK043520001B11
	8 m	DD	BSB 35-50 Tuchel 5-pol.	Standard	7S9SK083520001B11
	4 m	DD	BSB 35-50 Tuchel 5-pol.	High Flex Leder	7S9SH043520001B11
	8 m	DD	BSB 35-50 Tuchel 5-pol.	High Flex Leder	7S9SH083520001B11
ABITIG® 24W Little	4 m	DD	BSB 35-50 Tuchel 5-pol.	High Flex Leder	7L9SH043520001B11
	8 m	DD	BSB 35-50 Tuchel 5-pol.	High Flex Leder	7L9SH083520001B11
<hr/>					
ABITIG® 450W	4 m	DD	BSB 35-50 Tuchel 5-pol.	Standard	7T5SK043520101B11
	8 m	DD	BSB 35-50 Tuchel 5-pol.	Standard	7T5SK083520101B11
	4 m	DD	BSB 35-50 Tuchel 5-pol.	High Flex Leder	7T5SH043520101B11
	8 m	DD	BSB 35-50 Tuchel 5-pol.	High Flex Leder	7T5SH083520101B11
<hr/>					
ABITIG® 260W	4 m	DD	BSB 35-50 Tuchel 5-pol.	Standard	7T7SK043520101B11
	8 m	DD	BSB 35-50 Tuchel 5-pol.	Standard	7T7SK083520101B11
	4 m	DD	BSB 35-50 Tuchel 5-pol.	High Flex Leder	7T7SH043520101B11
	8 m	DD	BSB 35-50 Tuchel 5-pol.	High Flex Leder	7T7SH083520101B11
ABITIG® 260W Little	4 m	DD	BSB 35-50 Tuchel 5-pol.	High Flex Leder	7L7SH043520101B11
	8 m	DD	BSB 35-50 Tuchel 5-pol.	High Flex Leder	7L7SH083520101B11
<hr/>					
ABITIG® 450W SC	4 m	DD	BSB 35-50 Tuchel 5-pol.	Standard	
	8 m	DD	BSB 35-50 Tuchel 5-pol.	Standard	
	4 m	DD	BSB 35-50 Tuchel 5-pol.	High Flex Leder	7T8SH043520101B11
	8 m	DD	BSB 35-50 Tuchel 5-pol.	High Flex Leder	7T8SH083520101B11

ABITIG® GRIP / ABITIG® GRIP Little-Brennerpreisliste

passend für WIG-Stromquellen des Fabrikates „lorch“



Brennertyp	Länge	Schalterfunktion	maschinenseitiger Anschluss	Schlauchpaketausführung	Bestellnummer
ABITIG® 9	4 m	DD	BSB 35-50 Tuchel 5-pol.	Standard	7S1SK043520002B05
	8 m	DD	BSB 35-50 Tuchel 5-pol.	Standard	7S1SK083520002B05
	4 m	DD	BSB 35-50 Tuchel 5-pol.	High Flex Leder	7S1SH043520002B05
	8 m	DD	BSB 35-50 Tuchel 5-pol.	High Flex Leder	7S1SH083520002B05
ABITIG® 9 Little	4 m	DD	BSB 35-50 Tuchel 5-pol.	High Flex Leder	7L1SH043520002B05
	8 m	DD	BSB 35-50 Tuchel 5-pol.	High Flex Leder	7L1SH083520002B05
ABITIG® 9F	4 m	DD	BSB 35-50 Tuchel 5-pol.	Standard	7S1FK043520002B05
	8 m	DD	BSB 35-50 Tuchel 5-pol.	Standard	7S1FK083520002B05
	4 m	DD	BSB 35-50 Tuchel 5-pol.	High Flex Leder	7S1FH043520002B05
	8 m	DD	BSB 35-50 Tuchel 5-pol.	High Flex Leder	7S1FH083520002B05
ABITIG® 9F Little	4 m	DD	BSB 35-50 Tuchel 5-pol.	High Flex Leder	7L1FH043520002B05
	8 m	DD	BSB 35-50 Tuchel 5-pol.	High Flex Leder	7L1FH083520002B05
ABITIG® 17	4 m	DD	BSB 35-50 Tuchel 5-pol.	Standard	7S2SK043520002B05
	8 m	DD	BSB 35-50 Tuchel 5-pol.	Standard	7S2SK083520002B05
	4 m	DD	BSB 35-50 Tuchel 5-pol.	High Flex Leder	7S2SH043520002B05
	8 m	DD	BSB 35-50 Tuchel 5-pol.	High Flex Leder	7S2SH083520002B05
ABITIG® 17 Little	4 m	DD	BSB 35-50 Tuchel 5-pol.	High Flex Leder	7L2SH043520002B05
	8 m	DD	BSB 35-50 Tuchel 5-pol.	High Flex Leder	7L2SH083520002B05
ABITIG® 17F	4 m	DD	BSB 35-50 Tuchel 5-pol.	Standard	7S2FK043520002B05
	8 m	DD	BSB 35-50 Tuchel 5-pol.	Standard	7S2FK083520002B05
	4 m	DD	BSB 35-50 Tuchel 5-pol.	High Flex Leder	7S2FH043520002B05
	8 m	DD	BSB 35-50 Tuchel 5-pol.	High Flex Leder	7S2FH083520002B05
ABITIG® 17F Little	4 m	DD	BSB 35-50 Tuchel 5-pol.	High Flex Leder	7L2FH043520002B05
	8 m	DD	BSB 35-50 Tuchel 5-pol.	High Flex Leder	7L2FH083520002B05

Technische Änderungen vorbehalten • Verkaufspreise = unverbindliche Preisempfehlung – Angebot freibleibend • © Copyright

ABITIG® GRIP / ABITIG® GRIP Little-Brennerpreisliste

passend für WIG-Stromquellen des Fabrikates „lorch“

Brennertyp	Länge	Schalterfunktion	maschinenseitiger Anschluss	Schlauchpaketausführung	Bestellnummer
ABITIG® 26	4 m	DD	BSB 35-50 Tuchel 5-pol.	Standard	7S3SK043520002B05
	8 m	DD	BSB 35-50 Tuchel 5-pol.	Standard	7S3SK083520002B05
	4 m	DD	BSB 35-50 Tuchel 5-pol.	High Flex Leder	7S3SH043520002B05
	8 m	DD	BSB 35-50 Tuchel 5-pol.	High Flex Leder	7S3SH083520002B05
ABITIG® 26F	4 m	DD	BSB 35-50 Tuchel 5-pol.	Standard	7S3FK043520002B05
	8 m	DD	BSB 35-50 Tuchel 5-pol.	Standard	7S3FK083520002B05
	4 m	DD	BSB 35-50 Tuchel 5-pol.	High Flex Leder	7S3FH043520002B05
	8 m	DD	BSB 35-50 Tuchel 5-pol.	High Flex Leder	7S3FH083520002B05
ABITIG® 24G	4 m	DD	BSB 35-50 Tuchel 5-pol.	Standard	7S8SK043520002B05
	8 m	DD	BSB 35-50 Tuchel 5-pol.	Standard	7S8SK083520002B05
	4 m	DD	BSB 35-50 Tuchel 5-pol.	High Flex Leder	7S8SH043520002B05
	8 m	DD	BSB 35-50 Tuchel 5-pol.	High Flex Leder	7S8SH083520002B05
ABITIG® 24G Little	4 m	DD	BSB 35-50 Tuchel 5-pol.	High Flex Leder	7L8SH043520002B05
	8 m	DD	BSB 35-50 Tuchel 5-pol.	High Flex Leder	7L8SH083520002B05
ABITIG® 200	4 m	DD	BSB 35-50 Tuchel 5-pol.	Standard	7T4SK043520002B05
	8 m	DD	BSB 35-50 Tuchel 5-pol.	Standard	7T4SK083520002B05
	4 m	DD	BSB 35-50 Tuchel 5-pol.	High Flex Leder	7T4SH043520002B05
	8 m	DD	BSB 35-50 Tuchel 5-pol.	High Flex Leder	7T4SH083520002B05
ABITIG® 200F	4 m	DD	BSB 35-50 Tuchel 5-pol.	Standard	7T4FK043520002B05
	8 m	DD	BSB 35-50 Tuchel 5-pol.	Standard	7T4FK083520002B05
	4 m	DD	BSB 35-50 Tuchel 5-pol.	High Flex Leder	7T4FH043520002B05
	8 m	DD	BSB 35-50 Tuchel 5-pol.	High Flex Leder	7T4FH083520002B05
ABITIG® 150	4 m	DD	BSB 35-50 Tuchel 5-pol.	Standard	7T6SK043520002B05
	8 m	DD	BSB 35-50 Tuchel 5-pol.	Standard	7T6SK083520002B05
	4 m	DD	BSB 35-50 Tuchel 5-pol.	High Flex Leder	7T6SH043520002B05
	8 m	DD	BSB 35-50 Tuchel 5-pol.	High Flex Leder	7T6SH083520002B05
ABITIG® 150 Little	4 m	DD	BSB 35-50 Tuchel 5-pol.	High Flex Leder	7L6SH043520002B05
	8 m	DD	BSB 35-50 Tuchel 5-pol.	High Flex Leder	7L6SH083520002B05
ABITIG® 150F	4 m	DD	BSB 35-50 Tuchel 5-pol.	Standard	7T6FK043520002B05
	8 m	DD	BSB 35-50 Tuchel 5-pol.	Standard	7T6FK083520002B05
	4 m	DD	BSB 35-50 Tuchel 5-pol.	High Flex Leder	7T6FH043520002B05
	8 m	DD	BSB 35-50 Tuchel 5-pol.	High Flex Leder	7T6FH083520002B05
ABITIG® 150F Little	4 m	DD	BSB 35-50 Tuchel 5-pol.	High Flex Leder	7L6FH043520002B05
	8 m	DD	BSB 35-50 Tuchel 5-pol.	High Flex Leder	7L6FH083520002B05

ABITIG® GRIP / ABITIG® GRIP Little-Brennerpreisliste

passend für WIG-Stromquellen des Fabrikates „lorch“



weiß braun
braun grün
grün weiß

Brennertyp	Länge	Schalterfunktion	maschinenseitiger Anschluss	Schlauchpaketausführung	Bestellnummer
ABITIG® 9	4 m	ED/DD	ZA - WTG-5	Standard	7S1SK043520498A00
	8 m	ED/DD	ZA - WTG-5	Standard	7S1SK083520498A00
	4 m	ED/DD	ZA - WTG-5	High Flex Leder	7S1SH043520498A00
	8 m	ED/DD	ZA - WTG-5	High Flex Leder	7S1SH083520498A00
ABITIG® 9 Little	4 m	ED/DD	ZA - WTG-5	High Flex Leder	7L1SH043520498A00
	8 m	ED/DD	ZA - WTG-5	High Flex Leder	7L1SH083520498A00
ABITIG® 9F	4 m	ED/DD	ZA - WTG-5	Standard	7S1FK043520498A00
	8 m	ED/DD	ZA - WTG-5	Standard	7S1FK083520498A00
	4 m	ED/DD	ZA - WTG-5	High Flex Leder	7S1FH043520498A00
	8 m	ED/DD	ZA - WTG-5	High Flex Leder	7S1FH083520498A00
ABITIG® 9F Little	4 m	ED/DD	ZA - WTG-5	High Flex Leder	7L1FH043520498A00
	8 m	ED/DD	ZA - WTG-5	High Flex Leder	7L1FH083520498A00
ABITIG® 17	4 m	ED/DD	ZA - WTG-5	Standard	7S2SK043520498A00
	8 m	ED/DD	ZA - WTG-5	Standard	7S2SK083520498A00
	4 m	ED/DD	ZA - WTG-5	High Flex Leder	7S2SH043520498A00
	8 m	ED/DD	ZA - WTG-5	High Flex Leder	7S2SH083520498A00
ABITIG® 17 Little	4 m	ED/DD	ZA - WTG-5	High Flex Leder	7L2SH043520498A00
	8 m	ED/DD	ZA - WTG-5	High Flex Leder	7L2SH083520498A00
ABITIG® 17F	4 m	ED/DD	ZA - WTG-5	Standard	7S2FK043520498A00
	8 m	ED/DD	ZA - WTG-5	Standard	7S2FK083520498A00
	4 m	ED/DD	ZA - WTG-5	High Flex Leder	7S2FH043520498A00
	8 m	ED/DD	ZA - WTG-5	High Flex Leder	7S2FH083520498A00
ABITIG® 17F Little	4 m	ED/DD	ZA - WTG-5	High Flex Leder	7L2FH043520498A00
	8 m	ED/DD	ZA - WTG-5	High Flex Leder	7L2FH083520498A00

Technische Änderungen vorbehalten • Verkaufspreise = unverbindliche Preisempfehlung - Angebot freibleibend • © Copyright

ABITIG® GRIP / ABITIG® GRIP Little-Brennerpreisliste

passend für WIG-Stromquellen des Fabrikates „lorch“

Brennertyp	Länge	Schalterfunktion	maschinenseitiger Anschluss	Schlauchpaketausführung	Bestellnummer
ABITIG® 26	4 m	ED/DD	ZA - WTG-5	Standard	7S3SK043520498A00
	8 m	ED/DD	ZA - WTG-5	Standard	7S3SK083520498A00
	4 m	ED/DD	ZA - WTG-5	High Flex Leder	7S3SH043520498A00
	8 m	ED/DD	ZA - WTG-5	High Flex Leder	7S3SH083520498A00
ABITIG® 26F	4 m	ED/DD	ZA - WTG-5	Standard	7S3FK043520498A00
	8 m	ED/DD	ZA - WTG-5	Standard	7S3FK083520498A00
	4 m	ED/DD	ZA - WTG-5	High Flex Leder	7S3FH043520498A00
	8 m	ED/DD	ZA - WTG-5	High Flex Leder	7S3FH083520498A00
ABITIG® 24G	4 m	ED/DD	ZA - WTG-5	Standard	7S8SK043520498A00
	8 m	ED/DD	ZA - WTG-5	Standard	7S8SK083520498A00
	4 m	ED/DD	ZA - WTG-5	High Flex Leder	7S8SH043520498A00
	8 m	ED/DD	ZA - WTG-5	High Flex Leder	7S8SH083520498A00
ABITIG® 24G Little	4 m	ED/DD	ZA - WTG-5	High Flex Leder	7L8SH043520498A00
	8 m	ED/DD	ZA - WTG-5	High Flex Leder	7L8SH083520498A00
ABITIG® 200	4 m	ED/DD	ZA - WTG-5	Standard	7T4SK043520498A00
	8 m	ED/DD	ZA - WTG-5	Standard	7T4SK083520498A00
	4 m	ED/DD	ZA - WTG-5	High Flex Leder	7T4SH043520498A00
	8 m	ED/DD	ZA - WTG-5	High Flex Leder	7T4SH083520498A00
ABITIG® 200F	4 m	ED/DD	ZA - WTG-5	Standard	7T4FK043520498A00
	8 m	ED/DD	ZA - WTG-5	Standard	7T4FK083520498A00
	4 m	ED/DD	ZA - WTG-5	High Flex Leder	7T4FH043520498A00
	8 m	ED/DD	ZA - WTG-5	High Flex Leder	7T4FH083520498A00
ABITIG® 150	4 m	ED/DD	ZA - WTG-5	Standard	7T6SK043520498A00
	8 m	ED/DD	ZA - WTG-5	Standard	7T6SK083520498A00
	4 m	ED/DD	ZA - WTG-5	High Flex Leder	7T6SH043520498A00
	8 m	ED/DD	ZA - WTG-5	High Flex Leder	7T6SH083520498A00
ABITIG® 150 Little	4 m	ED/DD	ZA - WTG-5	High Flex Leder	7L6SH043520498A00
	8 m	ED/DD	ZA - WTG-5	High Flex Leder	7L6SH083520498A00
ABITIG® 150F	4 m	ED/DD	ZA - WTG-5	Standard	7T6FK043520498A00
	8 m	ED/DD	ZA - WTG-5	Standard	7T6FK083520498A00
	4 m	ED/DD	ZA - WTG-5	High Flex Leder	7T6FH043520498A00
	8 m	ED/DD	ZA - WTG-5	High Flex Leder	7T6FH083520498A00
ABITIG® 150F Little	4 m	ED/DD	ZA - WTG-5	High Flex Leder	7L6FH043520498A00
	8 m	ED/DD	ZA - WTG-5	High Flex Leder	7L6FH083520498A00

ABITIG® GRIP / ABITIG® GRIP Little-Brennerpreisliste

passend für WIG-Stromquellen des Fabrikates „lorch“

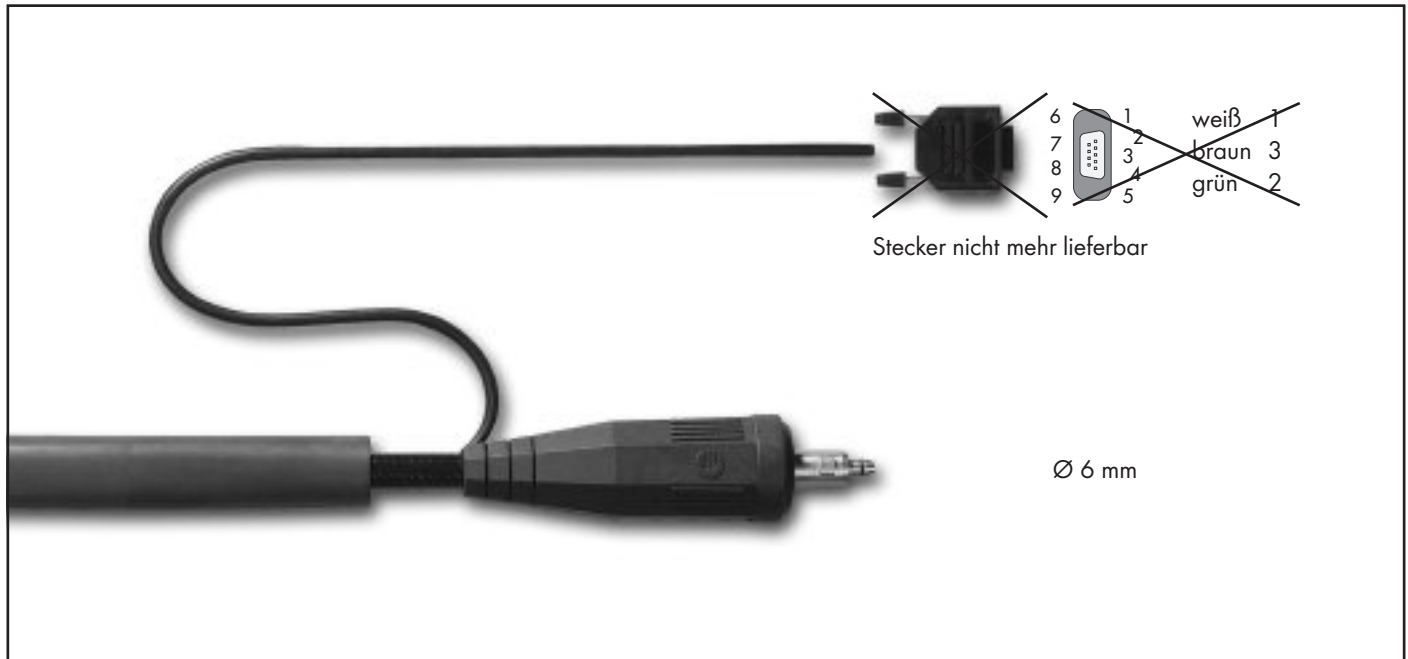

Brennertyp	Länge	Schalterfunktion	maschinenseitiger Anschluss	Schlauchpaketausführung	Bestellnummer
ABITIG® 9	4 m	DD	lorch - BSB / CG offen	Standard	7S1SK043522300000
	8 m	DD	lorch - BSB / CG offen	Standard	7S1SK083522300000
	4 m	DD	lorch - BSB / CG offen	High Flex Leder	7S1SH043522300000
	8 m	DD	lorch - BSB / CG offen	High Flex Leder	7S1SH083522300000
ABITIG® 9 Little	4 m	DD	lorch - BSB / CG offen	High Flex Leder	7L1SH043522300000
	8 m	DD	lorch - BSB / CG offen	High Flex Leder	7L1SH083522300000
ABITIG® 9F	4 m	DD	lorch - BSB / CG offen	Standard	7S1FK043522300000
	8 m	DD	lorch - BSB / CG offen	Standard	7S1FK083522300000
	4 m	DD	lorch - BSB / CG offen	High Flex Leder	7S1FH043522300000
	8 m	DD	lorch - BSB / CG offen	High Flex Leder	7S1FH083522300000
ABITIG® 9F Little	4 m	DD	lorch - BSB / CG offen	High Flex Leder	7L1FH043522300000
	8 m	DD	lorch - BSB / CG offen	High Flex Leder	7L1FH083522300000
ABITIG® 17	4 m	DD	lorch - BSB / CG offen	Standard	7S2SK043522300000
	8 m	DD	lorch - BSB / CG offen	Standard	7S2SK083522300000
	4 m	DD	lorch - BSB / CG offen	High Flex Leder	7S2SH043522300000
	8 m	DD	lorch - BSB / CG offen	High Flex Leder	7S2SH083522300000
ABITIG® 17 Little	4 m	DD	lorch - BSB / CG offen	High Flex Leder	7L2SH043522300000
	8 m	DD	lorch - BSB / CG offen	High Flex Leder	7L2SH083522300000
ABITIG® 17F	4 m	DD	lorch - BSB / CG offen	Standard	7S2FK043522300000
	8 m	DD	lorch - BSB / CG offen	Standard	7S2FK083522300000
	4 m	DD	lorch - BSB / CG offen	High Flex Leder	7S2FH043522300000
	8 m	DD	lorch - BSB / CG offen	High Flex Leder	7S2FH083522300000
ABITIG® 17F Little	4 m	DD	lorch - BSB / CG offen	High Flex Leder	7L2FH043522300000
	8 m	DD	lorch - BSB / CG offen	High Flex Leder	7L2FH083522300000

Technische Änderungen vorbehalten • Verkaufspreise = unverbindliche Preisempfehlung - Angebot freibleibend • © Copyright

ABITIG® GRIP / ABITIG® GRIP Little-Brennerpreisliste

passend für WIG-Stromquellen des Fabrikates „lorch“

Brennertyp	Länge	Schalterfunktion	maschinenseitiger Anschluss	Schlauchpaketausführung	Bestellnummer
ABITIG® 26	4 m	DD	lorch - BSB / CG offen	Standard	7S3SK043522300000
	8 m	DD	lorch - BSB / CG offen	Standard	7S3SK083522300000
	4 m	DD	lorch - BSB / CG offen	High Flex Leder	7S3SH043522300000
	8 m	DD	lorch - BSB / CG offen	High Flex Leder	7S3SH083522300000
ABITIG® 26F	4 m	DD	lorch - BSB / CG offen	Standard	7S3FK043522300000
	8 m	DD	lorch - BSB / CG offen	Standard	7S3FK083522300000
	4 m	DD	lorch - BSB / CG offen	High Flex Leder	7S3FH043522300000
	8 m	DD	lorch - BSB / CG offen	High Flex Leder	7S3FH083522300000
ABITIG® 24G	4 m	DD	lorch - BSB / CG offen	Standard	7S8SK043522300000
	8 m	DD	lorch - BSB / CG offen	Standard	7S8SK083522300000
	4 m	DD	lorch - BSB / CG offen	High Flex Leder	7S8SH043522300000
	8 m	DD	lorch - BSB / CG offen	High Flex Leder	7S8SH083522300000
ABITIG® 24G Little	4 m	DD	lorch - BSB / CG offen	High Flex Leder	7L8SH043522300000
	8 m	DD	lorch - BSB / CG offen	High Flex Leder	7L8SH083522300000
ABITIG® 200	4 m	DD	lorch - BSB / CG offen	Standard	7T4SK043522300000
	8 m	DD	lorch - BSB / CG offen	Standard	7T4SK083522300000
	4 m	DD	lorch - BSB / CG offen	High Flex Leder	7T4SH043522300000
	8 m	DD	lorch - BSB / CG offen	High Flex Leder	7T4SH083522300000
ABITIG® 200F	4 m	DD	lorch - BSB / CG offen	Standard	7T4FK043522300000
	8 m	DD	lorch - BSB / CG offen	Standard	7T4FK083522300000
	4 m	DD	lorch - BSB / CG offen	High Flex Leder	7T4FH043522300000
	8 m	DD	lorch - BSB / CG offen	High Flex Leder	7T4FH083522300000
ABITIG® 150	4 m	DD	lorch - BSB / CG offen	Standard	7T6SK043522300000
	8 m	DD	lorch - BSB / CG offen	Standard	7T6SK083522300000
	4 m	DD	lorch - BSB / CG offen	High Flex Leder	7T6SH043522300000
	8 m	DD	lorch - BSB / CG offen	High Flex Leder	7T6SH083522300000
ABITIG® 150 Little	4 m	DD	lorch - BSB / CG offen	High Flex Leder	7L6SH043522300000
	8 m	DD	lorch - BSB / CG offen	High Flex Leder	7L6SH083522300000
ABITIG® 150F	4 m	DD	lorch - BSB / CG offen	Standard	7T6FK043522300000
	8 m	DD	lorch - BSB / CG offen	Standard	7T6FK083522300000
	4 m	DD	lorch - BSB / CG offen	High Flex Leder	7T6FH043522300000
	8 m	DD	lorch - BSB / CG offen	High Flex Leder	7T6FH083522300000
ABITIG® 150F Little	4 m	DD	lorch - BSB / CG offen	High Flex Leder	7L6FH043522300000
	8 m	DD	lorch - BSB / CG offen	High Flex Leder	7L6FH083522300000

ABITIG® GRIP / ABITIG® GRIP Little-Brennerpreisliste

passend für WIG-Stromquellen des Fabrikates „lorch“

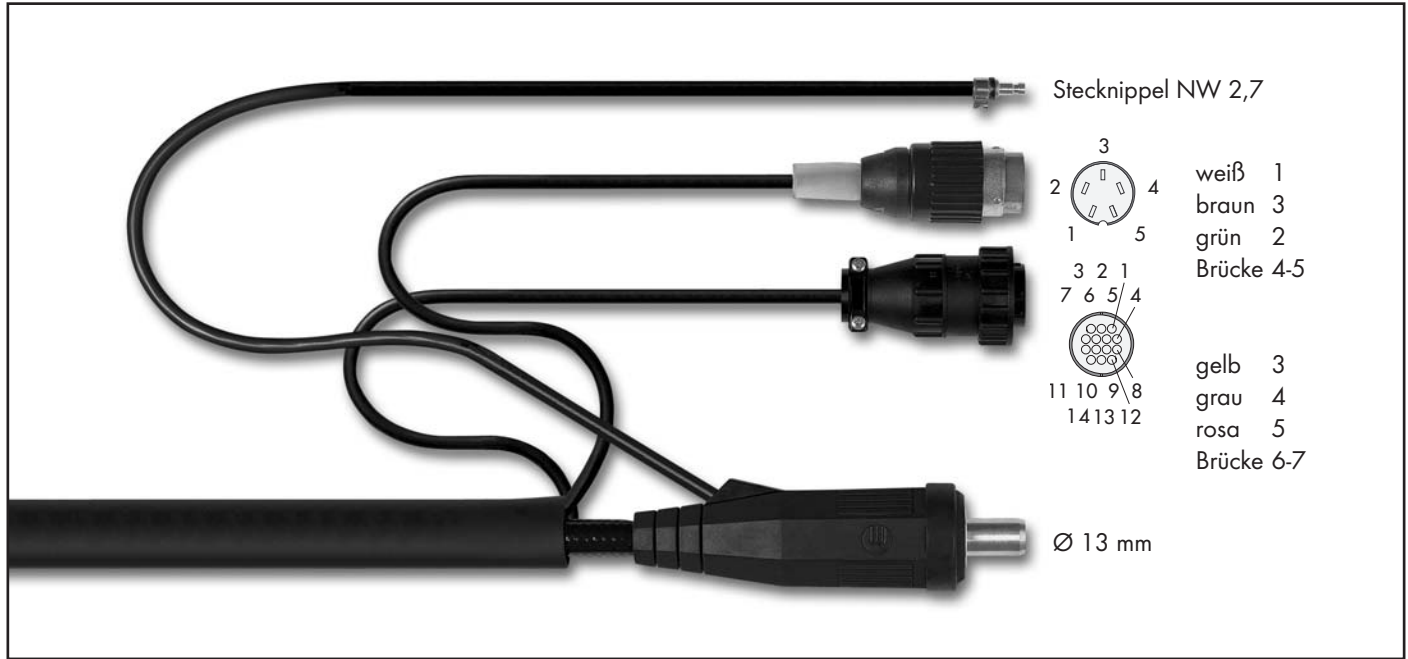

Brennertyp	Länge	Schalterfunktion	maschinenseitiger Anschluss	Schlauchpaketausführung	Bestellnummer
ABITIG® 9	4 m	DDP	BSB 35-50 Tuchel 5-pol.+ AMP 14-pol.	Standard	7S1SK046540036A05
	8 m	DDP	BSB 35-50 Tuchel 5-pol.+ AMP 14-pol.	Standard	7S1SK086540036A05
	4 m	DDP	BSB 35-50 Tuchel 5-pol.+ AMP 14-pol.	High Flex Leder	7S1SH046540036A05
	8 m	DDP	BSB 35-50 Tuchel 5-pol.+ AMP 14-pol.	High Flex Leder	7S1SH086540036A05
ABITIG® 9F	4 m	DDP	BSB 35-50 Tuchel 5-pol.+ AMP 14-pol.	Standard	7S1FK046540036A05
	8 m	DDP	BSB 35-50 Tuchel 5-pol.+ AMP 14-pol.	Standard	7S1FK086540036A05
	4 m	DDP	BSB 35-50 Tuchel 5-pol.+ AMP 14-pol.	High Flex Leder	7S1FH046540036A05
	8 m	DDP	BSB 35-50 Tuchel 5-pol.+ AMP 14-pol.	High Flex Leder	7S1FH086540036A05
ABITIG® 17	4 m	DDP	BSB 35-50 Tuchel 5-pol.+ AMP 14-pol.	Standard	7S2SK046540036A05
	8 m	DDP	BSB 35-50 Tuchel 5-pol.+ AMP 14-pol.	Standard	7S2SK086540036A05
	4 m	DDP	BSB 35-50 Tuchel 5-pol.+ AMP 14-pol.	High Flex Leder	7S2SH046540036A05
	8 m	DDP	BSB 35-50 Tuchel 5-pol.+ AMP 14-pol.	High Flex Leder	7S2SH086540036A05
ABITIG® 17F	4 m	DDP	BSB 35-50 Tuchel 5-pol.+ AMP 14-pol.	Standard	7S2FK046540036A05
	8 m	DDP	BSB 35-50 Tuchel 5-pol.+ AMP 14-pol.	Standard	7S2FK086540036A05
	4 m	DDP	BSB 35-50 Tuchel 5-pol.+ AMP 14-pol.	High Flex Leder	7S2FH046540036A05
	8 m	DDP	BSB 35-50 Tuchel 5-pol.+ AMP 14-pol.	High Flex Leder	7S2FH086540036A05

Technische Änderungen vorbehalten • Verkaufspreise = unverbindliche Preisempfehlung - Angebot freibleibend • © Copyright

ABITIG® GRIP / ABITIG® GRIP Little-Brennerpreisliste

passend für WIG-Stromquellen des Fabrikates „lorch“

Brennertyp	Länge	Schalterfunktion	maschinenseitiger Anschluss	Schlauchpaketausführung	Bestellnummer
ABITIG® 26	4 m	DDP	BSB 35-50 Tuchel 5-pol.+ AMP 14-pol.	Standard	7S3SK046540036A05
	8 m	DDP	BSB 35-50 Tuchel 5-pol.+ AMP 14-pol.	Standard	7S3SK086540036A05
	4 m	DDP	BSB 35-50 Tuchel 5-pol.+ AMP 14-pol.	High Flex Leder	7S3SH046540036A05
	8 m	DDP	BSB 35-50 Tuchel 5-pol.+ AMP 14-pol.	High Flex Leder	7S3SH086540036A05
ABITIG® 26F	4 m	DDP	BSB 35-50 Tuchel 5-pol.+ AMP 14-pol.	Standard	7S3FK046540036A05
	8 m	DDP	BSB 35-50 Tuchel 5-pol.+ AMP 14-pol.	Standard	7S3FK086540036A05
	4 m	DDP	BSB 35-50 Tuchel 5-pol.+ AMP 14-pol.	High Flex Leder	7S3FH046540036A05
	8 m	DDP	BSB 35-50 Tuchel 5-pol.+ AMP 14-pol.	High Flex Leder	7S3FH086540036A05
ABITIG® 24G	4 m	DDP	BSB 35-50 Tuchel 5-pol.+ AMP 14-pol.	Standard	7S8SK046540036A05
	8 m	DDP	BSB 35-50 Tuchel 5-pol.+ AMP 14-pol.	Standard	7S8SK086540036A05
	4 m	DDP	BSB 35-50 Tuchel 5-pol.+ AMP 14-pol.	High Flex Leder	7S8SH046540036A05
	8 m	DDP	BSB 35-50 Tuchel 5-pol.+ AMP 14-pol.	High Flex Leder	7S8SH086540036A05
ABITIG® 200	4 m	DDP	BSB 35-50 Tuchel 5-pol.+ AMP 14-pol.	Standard	7T4SK046540036A05
	8 m	DDP	BSB 35-50 Tuchel 5-pol.+ AMP 14-pol.	Standard	7T4SK086540036A05
	4 m	DDP	BSB 35-50 Tuchel 5-pol.+ AMP 14-pol.	High Flex Leder	7T4SH046540036A05
	8 m	DDP	BSB 35-50 Tuchel 5-pol.+ AMP 14-pol.	High Flex Leder	7T4SH086540036A05
ABITIG® 200F	4 m	DDP	BSB 35-50 Tuchel 5-pol.+ AMP 14-pol.	Standard	7T4FK046540036A05
	8 m	DDP	BSB 35-50 Tuchel 5-pol.+ AMP 14-pol.	Standard	7T4FK086540036A05
	4 m	DDP	BSB 35-50 Tuchel 5-pol.+ AMP 14-pol.	High Flex Leder	7T4FH046540036A05
	8 m	DDP	BSB 35-50 Tuchel 5-pol.+ AMP 14-pol.	High Flex Leder	7T4FH086540036A05
ABITIG® 150	4 m	DDP	BSB 35-50 Tuchel 5-pol.+ AMP 14-pol.	Standard	7T6SK046540036A05
	8 m	DDP	BSB 35-50 Tuchel 5-pol.+ AMP 14-pol.	Standard	7T6SK086540036A05
	4 m	DDP	BSB 35-50 Tuchel 5-pol.+ AMP 14-pol.	High Flex Leder	7T6SH046540036A05
	8 m	DDP	BSB 35-50 Tuchel 5-pol.+ AMP 14-pol.	High Flex Leder	7T6SH086540036A05
ABITIG® 150F	4 m	DDP	BSB 35-50 Tuchel 5-pol.+ AMP 14-pol.	Standard	7T6FK046540036A05
	8 m	DDP	BSB 35-50 Tuchel 5-pol.+ AMP 14-pol.	Standard	7T6FK086540036A05
	4 m	DDP	BSB 35-50 Tuchel 5-pol.+ AMP 14-pol.	High Flex Leder	7T6FH046540036A05
	8 m	DDP	BSB 35-50 Tuchel 5-pol.+ AMP 14-pol.	High Flex Leder	7T6FH086540036A05

ABITIG® GRIP / ABITIG® GRIP Little-Brennerpreisliste

passend für WIG-Stromquellen des Fabrikates „lorch“



Brennertyp	Länge	Schalterfunktion	maschinenseitiger Anschluss	Schlauchpaketausführung	Bestellnummer
ABITIG® 9	4 m	ED	MAG - ZA	Standard	7S1SK043513496A00
	8 m	ED	MAG - ZA	Standard	7S1SK083513496A00
	4 m	ED	MAG - ZA	High Flex Leder	7S1SH043513496A00
	8 m	ED	MAG - ZA	High Flex Leder	7S1SH083513496A00
ABITIG® 9 Little	4 m	ED	MAG - ZA	High Flex Leder	7L1SH043513496A00
	8 m	ED	MAG - ZA	High Flex Leder	7L1SH083513496A00
ABITIG® 9F	4 m	ED	MAG - ZA	Standard	7S1FK043513496A00
	8 m	ED	MAG - ZA	Standard	7S1FK083513496A00
	4 m	ED	MAG - ZA	High Flex Leder	7S1FH043513496A00
	8 m	ED	MAG - ZA	High Flex Leder	7S1FH083513496A00
ABITIG® 9F Little	4 m	ED	MAG - ZA	High Flex Leder	7L1FH043513496A00
	8 m	ED	MAG - ZA	High Flex Leder	7L1FH083513496A00
ABITIG® 17	4 m	ED	MAG - ZA	Standard	7S2SK043513496A00
	8 m	ED	MAG - ZA	Standard	7S2SK083513496A00
	4 m	ED	MAG - ZA	High Flex Leder	7S2SH043513496A00
	8 m	ED	MAG - ZA	High Flex Leder	7S2SH083513496A00
ABITIG® 17 Little	4 m	ED	MAG - ZA	High Flex Leder	7L2SH043513496A00
	8 m	ED	MAG - ZA	High Flex Leder	7L2SH083513496A00
ABITIG® 17F	4 m	ED	MAG - ZA	Standard	7S2FK043513496A00
	8 m	ED	MAG - ZA	Standard	7S2FK083513496A00
	4 m	ED	MAG - ZA	High Flex Leder	7S2FH043513496A00
	8 m	ED	MAG - ZA	High Flex Leder	7S2FH083513496A00
ABITIG® 17F Little	4 m	ED	MAG - ZA	High Flex Leder	7L2FH043513496A00
	8 m	ED	MAG - ZA	High Flex Leder	7L2FH083513496A00

Technische Änderungen vorbehalten • Verkaufspreise = unverbindliche Preisempfehlung - Angebot freibleibend • © Copyright

ABITIG® GRIP / ABITIG® GRIP Little-Brennerpreisliste

passend für WIG-Stromquellen des Fabrikates „lorch“

Brennertyp	Länge	Schalterfunktion	maschinenseitiger Anschluss	Schlauchpaketausführung	Bestellnummer
ABITIG® 26	4 m	ED	MAG - ZA	Standard	7S3SK043513496A00
	8 m	ED	MAG - ZA	Standard	7S3SK083513496A00
	4 m	ED	MAG - ZA	High Flex Leder	7S3SH043513496A00
	8 m	ED	MAG - ZA	High Flex Leder	7S3SH083513496A00
ABITIG® 26F	4 m	ED	MAG - ZA	Standard	7S3FK043513496A00
	8 m	ED	MAG - ZA	Standard	7S3FK083513496A00
	4 m	ED	MAG - ZA	High Flex Leder	7S3FH043513496A00
	8 m	ED	MAG - ZA	High Flex Leder	7S3FH083513496A00
ABITIG® 24G	4 m	ED	MAG - ZA	Standard	7S8SK043513496A00
	8 m	ED	MAG - ZA	Standard	7S8SK083513496A00
	4 m	ED	MAG - ZA	High Flex Leder	7S8SH043513496A00
	8 m	ED	MAG - ZA	High Flex Leder	7S8SH083513496A00
ABITIG® 24G Little	4 m	ED	MAG - ZA	High Flex Leder	7L8SH043513496A00
	8 m	ED	MAG - ZA	High Flex Leder	7L8SH083513496A00
ABITIG® 200	4 m	ED	MAG - ZA	Standard	7T4SK043513496A00
	8 m	ED	MAG - ZA	Standard	7T4SK083513496A00
	4 m	ED	MAG - ZA	High Flex Leder	7T4SH043513496A00
	8 m	ED	MAG - ZA	High Flex Leder	7T4SH083513496A00
ABITIG® 200F	4 m	ED	MAG - ZA	Standard	7T4FK043513496A00
	8 m	ED	MAG - ZA	Standard	7T4FK083513496A00
	4 m	ED	MAG - ZA	High Flex Leder	7T4FH043513496A00
	8 m	ED	MAG - ZA	High Flex Leder	7T4FH083513496A00
ABITIG® 150	4 m	ED	MAG - ZA	Standard	7T6SK043513496A00
	8 m	ED	MAG - ZA	Standard	7T6SK083513496A00
	4 m	ED	MAG - ZA	High Flex Leder	7T6SH043513496A00
	8 m	ED	MAG - ZA	High Flex Leder	7T6SH083513496A00
ABITIG® 150 Little	4 m	ED	MAG - ZA	High Flex Leder	7L6SH043513496A00
	8 m	ED	MAG - ZA	High Flex Leder	7L6SH083513496A00
ABITIG® 150F	4 m	ED	MAG - ZA	Standard	7T6FK043513496A00
	8 m	ED	MAG - ZA	Standard	7T6FK083513496A00
	4 m	ED	MAG - ZA	High Flex Leder	7T6FH043513496A00
	8 m	ED	MAG - ZA	High Flex Leder	7T6FH083513496A00
ABITIG® 150F Little	4 m	ED	MAG - ZA	High Flex Leder	7L6FH043513496A00
	8 m	ED	MAG - ZA	High Flex Leder	7L6FH083513496A00

ABITIG® GRIP / ABITIG® GRIP Little-Brennerpreisliste

passend für WIG-Stromquellen des Fabrikates „lorch“

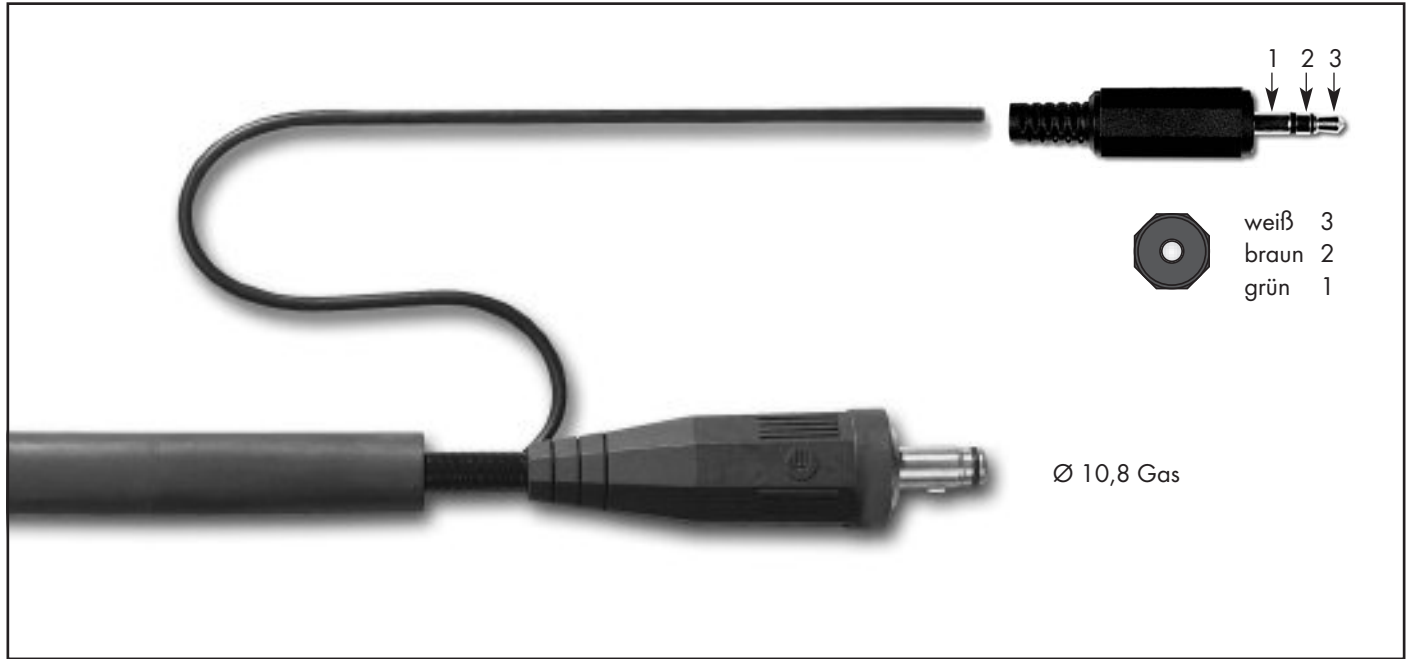

Brennertyp	Länge	Schalterfunktion	maschinenseitiger Anschluss	Schlauchpaketausführung	Bestellnummer
ABITIG® 9	4 m	DD	BSB CG/3-pol. Stecker	Standard	7S1SK043523859A00
	8 m	DD	BSB CG/3-pol. Stecker	Standard	7S1SK083523859A00
	4 m	DD	BSB CG/3-pol. Stecker	High Flex Leder	7S1SH043523859A00
	8 m	DD	BSB CG/3-pol. Stecker	High Flex Leder	7S1SH083523859A00
ABITIG® 9 Little	4 m	DD	BSB CG/3-pol. Stecker	High Flex Leder	7L1SH043523859A00
	8 m	DD	BSB CG/3-pol. Stecker	High Flex Leder	7L1SH083523859A00
ABITIG® 9F	4 m	DD	BSB CG/3-pol. Stecker	Standard	7S1FK043523859A00
	8 m	DD	BSB CG/3-pol. Stecker	Standard	7S1FK083523859A00
	4 m	DD	BSB CG/3-pol. Stecker	High Flex Leder	7S1FH043523859A00
	8 m	DD	BSB CG/3-pol. Stecker	High Flex Leder	7S1FH083523859A00
ABITIG® 9F Little	4 m	DD	BSB CG/3-pol. Stecker	High Flex Leder	7L1FH043523859A00
	8 m	DD	BSB CG/3-pol. Stecker	High Flex Leder	7L1FH083523859A00
ABITIG® 17	4 m	DD	BSB CG/3-pol. Stecker	Standard	7S2SK043523859A00
	8 m	DD	BSB CG/3-pol. Stecker	Standard	7S2SK083523859A00
	4 m	DD	BSB CG/3-pol. Stecker	High Flex Leder	7S2SH043523859A00
	8 m	DD	BSB CG/3-pol. Stecker	High Flex Leder	7S2SH083523859A00
ABITIG® 17 Little	4 m	DD	BSB CG/3-pol. Stecker	High Flex Leder	7L2SH043523859A00
	8 m	DD	BSB CG/3-pol. Stecker	High Flex Leder	7L2SH083523859A00
ABITIG® 17F	4 m	DD	BSB CG/3-pol. Stecker	Standard	7S2FK043523859A00
	8 m	DD	BSB CG/3-pol. Stecker	Standard	7S2FK083523859A00
	4 m	DD	BSB CG/3-pol. Stecker	High Flex Leder	7S2FH043523859A00
	8 m	DD	BSB CG/3-pol. Stecker	High Flex Leder	7S2FH083523859A00
ABITIG® 17F Little	4 m	DD	BSB CG/3-pol. Stecker	High Flex Leder	7L2FH043523859A00
	8 m	DD	BSB CG/3-pol. Stecker	High Flex Leder	7L2FH083523859A00

Technische Änderungen vorbehalten • Verkaufspreise = unverbindliche Preisempfehlung - Angebot freibleibend • © Copyright

ABITIG® GRIP / ABITIG® GRIP Little-Brennerpreisliste

passend für WIG-Stromquellen des Fabrikates „lorch“

Brennertyp	Länge	Schalterfunktion	maschinenseitiger Anschluss	Schlauchpaketausführung	Bestellnummer
ABITIG® 26	4 m	DD	BSB CG/3-pol. Stecker	Standard	7S3SK043523859A00
	8 m	DD	BSB CG/3-pol. Stecker	Standard	7S3SK083523859A00
	4 m	DD	BSB CG/3-pol. Stecker	High Flex Leder	7S3SH043523859A00
	8 m	DD	BSB CG/3-pol. Stecker	High Flex Leder	7S3SH083523859A00
ABITIG® 26F	4 m	DD	BSB CG/3-pol. Stecker	Standard	7S3FK043523859A00
	8 m	DD	BSB CG/3-pol. Stecker	Standard	7S3FK083523859A00
	4 m	DD	BSB CG/3-pol. Stecker	High Flex Leder	7S3FH043523859A00
	8 m	DD	BSB CG/3-pol. Stecker	High Flex Leder	7S3FH083523859A00
ABITIG® 24G	4 m	DD	BSB CG/3-pol. Stecker	Standard	7S8SK043523859A00
	8 m	DD	BSB CG/3-pol. Stecker	Standard	7S8SK083523859A00
	4 m	DD	BSB CG/3-pol. Stecker	High Flex Leder	7S8SH043523859A00
	8 m	DD	BSB CG/3-pol. Stecker	High Flex Leder	7S8SH083523859A00
ABITIG® 24G Little	4 m	DD	BSB CG/3-pol. Stecker	High Flex Leder	7L8SH043523859A00
	8 m	DD	BSB CG/3-pol. Stecker	High Flex Leder	7L8SH083523859A00
ABITIG® 200	4 m	DD	BSB CG/3-pol. Stecker	Standard	7T4SK043523859A00
	8 m	DD	BSB CG/3-pol. Stecker	Standard	7T4SK083523859A00
	4 m	DD	BSB CG/3-pol. Stecker	High Flex Leder	7T4SH043523859A00
	8 m	DD	BSB CG/3-pol. Stecker	High Flex Leder	7T4SH083523859A00
ABITIG® 200F	4 m	DD	BSB CG/3-pol. Stecker	Standard	7T4FK043523859A00
	8 m	DD	BSB CG/3-pol. Stecker	Standard	7T4FK083523859A00
	4 m	DD	BSB CG/3-pol. Stecker	High Flex Leder	7T4FH043523859A00
	8 m	DD	BSB CG/3-pol. Stecker	High Flex Leder	7T4FH083523859A00
ABITIG® 150	4 m	DD	BSB CG/3-pol. Stecker	Standard	7T6SK043523859A00
	8 m	DD	BSB CG/3-pol. Stecker	Standard	7T6SK083523859A00
	4 m	DD	BSB CG/3-pol. Stecker	High Flex Leder	7T6SH043523859A00
	8 m	DD	BSB CG/3-pol. Stecker	High Flex Leder	7T6SH083523859A00
ABITIG® 150 Little	4 m	DD	BSB CG/3-pol. Stecker	High Flex Leder	7L6SH043523859A00
	8 m	DD	BSB CG/3-pol. Stecker	High Flex Leder	7L6SH083523859A00
ABITIG® 150F	4 m	DD	BSB CG/3-pol. Stecker	Standard	7T6FK043523859A00
	8 m	DD	BSB CG/3-pol. Stecker	Standard	7T6FK083523859A00
	4 m	DD	BSB CG/3-pol. Stecker	High Flex Leder	7T6FH043523859A00
	8 m	DD	BSB CG/3-pol. Stecker	High Flex Leder	7T6FH083523859A00
ABITIG® 150F Little	4 m	DD	BSB CG/3-pol. Stecker	High Flex Leder	7L6FH043523859A00
	8 m	DD	BSB CG/3-pol. Stecker	High Flex Leder	7L6FH083523859A00

ABITIG® GRIP / ABITIG® GRIP Little-Brennerpreisliste

passend für WIG-Stromquellen des Fabrikates „lorch“



Brennertyp	Länge	Schalterfunktion	maschinenseitiger Anschluss	Schlauchpaketausführung	Bestellnummer
ABITIG® 9	4m	UD	BSB 35-50 Tuchel 5-pol.	Standard	7S1SK046950051A05
	8m	UD	BSB 35-50 Tuchel 5-pol.	Standard	7S1SK086950051A05
	4m	UD	BSB 35-50 Tuchel 5-pol.	High Flex Leder	7S1SH046950051A05
	8m	UD	BSB 35-50 Tuchel 5-pol.	High Flex Leder	7S1SH086950051A05
ABITIG® 9F	4m	UD	BSB 35-50 Tuchel 5-pol.	Standard	7S1FK046950051A05
	8m	UD	BSB 35-50 Tuchel 5-pol.	Standard	7S1FK086950051A05
	4m	UD	BSB 35-50 Tuchel 5-pol.	High Flex Leder	7S1FH046950051A05
	8m	UD	BSB 35-50 Tuchel 5-pol.	High Flex Leder	7S1FH086950051A05
ABITIG® 17	4m	UD	BSB 35-50 Tuchel 5-pol.	Standard	7S2SK046950051A05
	8m	UD	BSB 35-50 Tuchel 5-pol.	Standard	7S2SK086950051A05
	4m	UD	BSB 35-50 Tuchel 5-pol.	High Flex Leder	7S2SH046950051A05
	8m	UD	BSB 35-50 Tuchel 5-pol.	High Flex Leder	7S2SH086950051A05
ABITIG® 17F	4m	UD	BSB 35-50 Tuchel 5-pol.	Standard	7S2FK046950051A05
	8m	UD	BSB 35-50 Tuchel 5-pol.	Standard	7S2FK086950051A05
	4m	UD	BSB 35-50 Tuchel 5-pol.	High Flex Leder	7S2FH046950051A05
	8m	UD	BSB 35-50 Tuchel 5-pol.	High Flex Leder	7S2FH086950051A05

Technische Änderungen vorbehalten • Verkaufspreise = unverbindliche Preisempfehlung - Angebot freibleibend • © Copyright

ABITIG® GRIP / ABITIG® GRIP Little-Brennerpreisliste

passend für WIG-Stromquellen des Fabrikates „lorch“

Brennertyp	Länge	Schalterfunktion	maschinenseitiger Anschluss	Schlauchpaketausführung	Bestellnummer
ABITIG® 26	4m	UD	BSB 35-50 Tuchel 5-pol.	Standard	7S3SK046950051A05
	8m	UD	BSB 35-50 Tuchel 5-pol.	Standard	7S3SK086950051A05
	4m	UD	BSB 35-50 Tuchel 5-pol.	High Flex Leder	7S3SH046950051A05
	8m	UD	BSB 35-50 Tuchel 5-pol.	High Flex Leder	7S3SH086950051A05
ABITIG® 26F	4m	UD	BSB 35-50 Tuchel 5-pol.	Standard	7S3FK046950051A05
	8m	UD	BSB 35-50 Tuchel 5-pol.	Standard	7S3FK086950051A05
	4m	UD	BSB 35-50 Tuchel 5-pol.	High Flex Leder	7S3FH046950051A05
	8m	UD	BSB 35-50 Tuchel 5-pol.	High Flex Leder	7S3FH086950051A05
ABITIG® 24G	4m	UD	BSB 35-50 Tuchel 5-pol.	Standard	7S8SK046950051A05
	8m	UD	BSB 35-50 Tuchel 5-pol.	Standard	7S8SK086950051A05
	4m	UD	BSB 35-50 Tuchel 5-pol.	High Flex Leder	7S8SH046950051A05
	8m	UD	BSB 35-50 Tuchel 5-pol.	High Flex Leder	7S8SH086950051A05
ABITIG® 200	4m	UD	BSB 35-50 Tuchel 5-pol.	Standard	7T4SK046950051A05
	8m	UD	BSB 35-50 Tuchel 5-pol.	Standard	7T4SK086950051A05
	4m	UD	BSB 35-50 Tuchel 5-pol.	High Flex Leder	7T4SH046950051A05
	8m	UD	BSB 35-50 Tuchel 5-pol.	High Flex Leder	7T4SH086950051A05
ABITIG® 200F	4m	UD	BSB 35-50 Tuchel 5-pol.	Standard	7T4FK046950051A05
	8m	UD	BSB 35-50 Tuchel 5-pol.	Standard	7T4FK086950051A05
	4m	UD	BSB 35-50 Tuchel 5-pol.	High Flex Leder	7T4FH046950051A05
	8m	UD	BSB 35-50 Tuchel 5-pol.	High Flex Leder	7T4FH086950051A05
ABITIG® 150	4m	UD	BSB 35-50 Tuchel 5-pol.	Standard	7T6SK046950051A05
	8m	UD	BSB 35-50 Tuchel 5-pol.	Standard	7T6SK086950051A05
	4m	UD	BSB 35-50 Tuchel 5-pol.	High Flex Leder	7T6SH046950051A05
	8m	UD	BSB 35-50 Tuchel 5-pol.	High Flex Leder	7T6SH086950051A05
ABITIG® 150F	4m	UD	BSB 35-50 Tuchel 5-pol.	Standard	7T6FK046950051A05
	8m	UD	BSB 35-50 Tuchel 5-pol.	Standard	7T6FK086950051A05
	4m	UD	BSB 35-50 Tuchel 5-pol.	High Flex Leder	7T6FH046950051A05
	8m	UD	BSB 35-50 Tuchel 5-pol.	High Flex Leder	7T6FH086950051A05

ABITIG® GRIP / ABITIG® GRIP Little-Brennerpreisliste

passend für WIG-Stromquellen des Fabrikates „lorch“



Brennertyp	Länge	Schalterfunktion	maschinenseitiger Anschluss	Schlauchpaketausführung	Bestellnummer
ABITIG® 18	4 m	DD	BSB 35-50 Tuchel 5-pol.	Standard	7S4SK043520001B16
	8 m	DD	BSB 35-50 Tuchel 5-pol.	Standard	7S4SK083520001B16
	4 m	DD	BSB 35-50 Tuchel 5-pol.	High Flex Leder	7S4SH043520001B16
	8 m	DD	BSB 35-50 Tuchel 5-pol.	High Flex Leder	7S4SH083520001B16
ABITIG® 18F	4 m	DD	BSB 35-50 Tuchel 5-pol.	Standard	7S4FK043520001B16
	8 m	DD	BSB 35-50 Tuchel 5-pol.	Standard	7S4FK083520001B16
	4 m	DD	BSB 35-50 Tuchel 5-pol.	High Flex Leder	7S4FH043520001B16
	8 m	DD	BSB 35-50 Tuchel 5-pol.	High Flex Leder	7S4FH083520001B16
ABITIG® 20	4 m	DD	BSB 35-50 Tuchel 5-pol.	Standard	7S5SK043520001B16
	8 m	DD	BSB 35-50 Tuchel 5-pol.	Standard	7S5SK083520001B16
	4 m	DD	BSB 35-50 Tuchel 5-pol.	High Flex Leder	7S5SH043520001B16
	8 m	DD	BSB 35-50 Tuchel 5-pol.	High Flex Leder	7S5SH083520001B16
ABITIG® 20 Little	4 m	DD	BSB 35-50 Tuchel 5-pol.	High Flex Leder	7L5SH043520001B16
	8 m	DD	BSB 35-50 Tuchel 5-pol.	High Flex Leder	7L5SH083520001B16
ABITIG® 20F	4 m	DD	BSB 35-50 Tuchel 5-pol.	Standard	7S5FK043520001B16
	8 m	DD	BSB 35-50 Tuchel 5-pol.	Standard	7S5FK083520001B16
	4 m	DD	BSB 35-50 Tuchel 5-pol.	High Flex Leder	7S5FH043520001B16
	8 m	DD	BSB 35-50 Tuchel 5-pol.	High Flex Leder	7S5FH083520001B16
ABITIG® 20F Little	4 m	DD	BSB 35-50 Tuchel 5-pol.	High Flex Leder	7L5FH043520001B16
	8 m	DD	BSB 35-50 Tuchel 5-pol.	High Flex Leder	7L5FH083520001B16

Technische Änderungen vorbehalten • Verkaufspreise = unverbindliche Preisempfehlung - Angebot freibleibend • © Copyright

ABITIG® GRIP / ABITIG® GRIP Little-Brennerpreisliste

passend für WIG-Stromquellen des Fabrikates „lorch“

Brennertyp	Länge	Schalterfunktion	maschinenseitiger Anschluss	Schlauchpaketausführung	Bestellnummer
ABITIG® 12-1	4 m	DD	BSB 35-50 Tuchel 5-pol.	Standard	7S6SK043520001B16
	8 m	DD	BSB 35-50 Tuchel 5-pol.	Standard	7S6SK083520001B16
	4 m	DD	BSB 35-50 Tuchel 5-pol.	High Flex Leder	7S6SH043520001B16
	8 m	DD	BSB 35-50 Tuchel 5-pol.	High Flex Leder	7S6SH083520001B16
<hr/>					
ABITIG® 18SC	4 m	DD	BSB 35-50 Tuchel 5-pol.	Standard	7S7SK043520001B16
	8 m	DD	BSB 35-50 Tuchel 5-pol.	Standard	7S7SK083520001B16
	4 m	DD	BSB 35-50 Tuchel 5-pol.	High Flex Leder	7S7SH043520001B16
	8 m	DD	BSB 35-50 Tuchel 5-pol.	High Flex Leder	7S7SH083520001B16
<hr/>					
ABITIG® 24W	4 m	DD	BSB 35-50 Tuchel 5-pol.	Standard	7S9SK043520001B16
	8 m	DD	BSB 35-50 Tuchel 5-pol.	Standard	7S9SK083520001B16
	4 m	DD	BSB 35-50 Tuchel 5-pol.	High Flex Leder	7S9SH043520001B16
	8 m	DD	BSB 35-50 Tuchel 5-pol.	High Flex Leder	7S9SH083520001B16
ABITIG® 24W Little	4 m	DD	BSB 35-50 Tuchel 5-pol.	High Flex Leder	7L9SH043520001B16
	8 m	DD	BSB 35-50 Tuchel 5-pol.	High Flex Leder	7L9SH083520001B16
<hr/>					
ABITIG® 450W	4 m	DD	BSB 35-50 Tuchel 5-pol.	Standard	7T5SK043520101B16
	8 m	DD	BSB 35-50 Tuchel 5-pol.	Standard	7T5SK083520101B16
	4 m	DD	BSB 35-50 Tuchel 5-pol.	High Flex Leder	7T5SH043520101B16
	8 m	DD	BSB 35-50 Tuchel 5-pol.	High Flex Leder	7T5SH083520101B16
<hr/>					
ABITIG® 260W	4 m	DD	BSB 35-50 Tuchel 5-pol.	Standard	7T7SK043520101B16
	8 m	DD	BSB 35-50 Tuchel 5-pol.	Standard	7T7SK083520101B16
	4 m	DD	BSB 35-50 Tuchel 5-pol.	High Flex Leder	7T7SH043520101B16
	8 m	DD	BSB 35-50 Tuchel 5-pol.	High Flex Leder	7T7SH083520101B16
ABITIG® 260W Little	4 m	DD	BSB 35-50 Tuchel 5-pol.	High Flex Leder	7L7SH043520101B16
	8 m	DD	BSB 35-50 Tuchel 5-pol.	High Flex Leder	7L7SH083520101B16
<hr/>					
ABITIG® 450W SC	4 m	DD	BSB 35-50 Tuchel 5-pol.	Standard	
	8 m	DD	BSB 35-50 Tuchel 5-pol.	Standard	
	4 m	DD	BSB 35-50 Tuchel 5-pol.	High Flex Leder	7T8SH043520101B16
	8 m	DD	BSB 35-50 Tuchel 5-pol.	High Flex Leder	7T8SH083520101B16

ABITIG® GRIP / ABITIG® GRIP Little-Brennerpreisliste

passend für WIG-Stromquellen des Fabrikates „lorch“



Brennertyp	Länge	Schalterfunktion	maschinenseitiger Anschluss	Schlauchpaketausführung	Bestellnummer
ABITIG® 18	4 m	ED/DD	ZA - WTW-5	Standard	7S4SK043520498A12
	8 m	ED/DD	ZA - WTW-5	Standard	7S4SK083520498A12
	4 m	ED/DD	ZA - WTW-5	High Flex Leder	7S4SH043520498A12
	8 m	ED/DD	ZA - WTW-5	High Flex Leder	7S4SH083520498A12
ABITIG® 18F	4 m	ED/DD	ZA - WTW-5	Standard	7S4FK043520498A12
	8 m	ED/DD	ZA - WTW-5	Standard	7S4FK083520498A12
	4 m	ED/DD	ZA - WTW-5	High Flex Leder	7S4FH043520498A12
	8 m	ED/DD	ZA - WTW-5	High Flex Leder	7S4FH083520498A12
ABITIG® 20	4 m	ED/DD	ZA - WTW-5	Standard	7S5SK043520498A12
	8 m	ED/DD	ZA - WTW-5	Standard	7S5SK083520498A12
	4 m	ED/DD	ZA - WTW-5	High Flex Leder	7S5SH043520498A12
	8 m	ED/DD	ZA - WTW-5	High Flex Leder	7S5SH083520498A12
ABITIG® 20 Little	4 m	ED/DD	ZA - WTW-5	High Flex Leder	7L5SH043520498A12
	8 m	ED/DD	ZA - WTW-5	High Flex Leder	7L5SH083520498A12
ABITIG® 20F	4 m	ED/DD	ZA - WTW-5	Standard	7S5FK043520498A12
	8 m	ED/DD	ZA - WTW-5	Standard	7S5FK083520498A12
	4 m	ED/DD	ZA - WTW-5	High Flex Leder	7S5FH043520498A12
	8 m	ED/DD	ZA - WTW-5	High Flex Leder	7S5FH083520498A12
ABITIG® 20F Little	4 m	ED/DD	ZA - WTW-5	High Flex Leder	7L5FH043520498A12
	8 m	ED/DD	ZA - WTW-5	High Flex Leder	7L5FH083520498A12

Technische Änderungen vorbehalten • Verkaufspreise = unverbindliche Preisempfehlung - Angebot freibleibend • © Copyright

ABITIG® GRIP / ABITIG® GRIP Little-Brennerpreisliste

passend für WIG-Stromquellen des Fabrikates „lorch“

Brennertyp	Länge	Schalterfunktion	maschinenseitiger Anschluss	Schlauchpaketausführung	Bestellnummer
ABITIG® 12-1	4 m	ED/DD	ZA - WTW-5	Standard	7S6SK043520498A12
	8 m	ED/DD	ZA - WTW-5	Standard	7S6SK083520498A12
	4 m	ED/DD	ZA - WTW-5	High Flex Leder	7S6SH043520498A12
	8 m	ED/DD	ZA - WTW-5	High Flex Leder	7S6SH083520498A12
ABITIG® 18SC	4 m	ED/DD	ZA - WTW-5	Standard	7S7SK043520498A12
	8 m	ED/DD	ZA - WTW-5	Standard	7S7SK083520498A12
	4 m	ED/DD	ZA - WTW-5	High Flex Leder	7S7SH043520498A12
	8 m	ED/DD	ZA - WTW-5	High Flex Leder	7S7SH083520498A12
ABITIG® 24W	4 m	ED/DD	ZA - WTW-5	Standard	7S9SK043520498A12
	8 m	ED/DD	ZA - WTW-5	Standard	7S9SK083520498A12
	4 m	ED/DD	ZA - WTW-5	High Flex Leder	7S9SH043520498A12
	8 m	ED/DD	ZA - WTW-5	High Flex Leder	7S9SH083520498A12
ABITIG® 24W Little	4 m	ED/DD	ZA - WTW-5	High Flex Leder	7L9SH043520498A12
	8 m	ED/DD	ZA - WTW-5	High Flex Leder	7L9SH083520498A12
ABITIG® 450W	4 m	ED/DD	ZA - WTW-5	Standard	7T5SK043520498A12
	8 m	ED/DD	ZA - WTW-5	Standard	7T5SK083520498A12
	4 m	ED/DD	ZA - WTW-5	High Flex Leder	7T5SH043520498A12
	8 m	ED/DD	ZA - WTW-5	High Flex Leder	7T5SH083520498A12
ABITIG® 260W	4 m	ED/DD	ZA - WTW-5	Standard	7T7SK043520498A12
	8 m	ED/DD	ZA - WTW-5	Standard	7T7SK083520498A12
	4 m	ED/DD	ZA - WTW-5	High Flex Leder	7T7SH043520498A12
	8 m	ED/DD	ZA - WTW-5	High Flex Leder	7T7SH083520498A12
ABITIG® 260W Little	4 m	ED/DD	ZA - WTW-5	High Flex Leder	7L7SH043520498A12
	8 m	ED/DD	ZA - WTW-5	High Flex Leder	7L7SH083520498A12
ABITIG® 450W SC	4 m	ED/DD	ZA - WTW-5	Standard	
	8 m	ED/DD	ZA - WTW-5	Standard	
	4 m	ED/DD	ZA - WTW-5	High Flex Leder	7T8SH043520498A12
	8 m	ED/DD	ZA - WTW-5	High Flex Leder	7T8SH083520498A12

ABITIG® GRIP / ABITIG® GRIP Little-Brennerpreisliste

passend für WIG-Stromquellen des Fabrikates „lorch“



Brennertyp	Länge	Schalterfunktion	maschinenseitiger Anschluss	Schlauchpaketausführung	Bestellnummer
ABITIG® 18	4 m	DD	lorch - BSB / CG offen	Standard	7S4SK043520200012
	8 m	DD	lorch - BSB / CG offen	Standard	7S4SK083520200012
	4 m	DD	lorch - BSB / CG offen	High Flex Leder	7S4SH043520200012
	8 m	DD	lorch - BSB / CG offen	High Flex Leder	7S4SH083520200012
ABITIG® 18F	4 m	DD	lorch - BSB / CG offen	Standard	7S4FK043520200012
	8 m	DD	lorch - BSB / CG offen	Standard	7S4FK083520200012
	4 m	DD	lorch - BSB / CG offen	High Flex Leder	7S4FH043520200012
	8 m	DD	lorch - BSB / CG offen	High Flex Leder	7S4FH083520200012
ABITIG® 20	4 m	DD	lorch - BSB / CG offen	Standard	7S5SK043520200012
	8 m	DD	lorch - BSB / CG offen	Standard	7S5SK083520200012
	4 m	DD	lorch - BSB / CG offen	High Flex Leder	7S5SH043520200012
	8 m	DD	lorch - BSB / CG offen	High Flex Leder	7S5SH083520200012
ABITIG® 20 Little	4 m	DD	lorch - BSB / CG offen	High Flex Leder	7L5SH043520200012
	8 m	DD	lorch - BSB / CG offen	High Flex Leder	7L5SH083520200012
ABITIG® 20F	4 m	DD	lorch - BSB / CG offen	Standard	7S5FK043520200012
	8 m	DD	lorch - BSB / CG offen	Standard	7S5FK083520200012
	4 m	DD	lorch - BSB / CG offen	High Flex Leder	7S5FH043520200012
	8 m	DD	lorch - BSB / CG offen	High Flex Leder	7S5FH083520200012
ABITIG® 20F Little	4 m	DD	lorch - BSB / CG offen	High Flex Leder	7L5FH043520200012
	8 m	DD	lorch - BSB / CG offen	High Flex Leder	7L5FH083520200012

Technische Änderungen vorbehalten • Verkaufspreise = unverbindliche Preisempfehlung - Angebot freibleibend • © Copyright

ABITIG® GRIP / ABITIG® GRIP Little-Brennerpreisliste

passend für WIG-Stromquellen des Fabrikates „lorch“

Brennertyp	Länge	Schalterfunktion	maschinenseitiger Anschluss	Schlauchpaketausführung	Bestellnummer
ABITIG® 12-1	4 m	DD	lorch - BSB / CG offen	Standard	7S6SK043520200012
	8 m	DD	lorch - BSB / CG offen	Standard	7S6SK083520200012
	4 m	DD	lorch - BSB / CG offen	High Flex Leder	7S6SH043520200012
	8 m	DD	lorch - BSB / CG offen	High Flex Leder	7S6SH083520200012
ABITIG® 18SC	4 m	DD	lorch - BSB / CG offen	Standard	7S7SK043520200012
	8 m	DD	lorch - BSB / CG offen	Standard	7S7SK083520200012
	4 m	DD	lorch - BSB / CG offen	High Flex Leder	7S7SH043520200012
	8 m	DD	lorch - BSB / CG offen	High Flex Leder	7S7SH083520200012
ABITIG® 24W	4 m	DD	lorch - BSB / CG offen	Standard	7S9SK043520200012
	8 m	DD	lorch - BSB / CG offen	Standard	7S9SK083520200012
	4 m	DD	lorch - BSB / CG offen	High Flex Leder	7S9SH043520200012
	8 m	DD	lorch - BSB / CG offen	High Flex Leder	7S9SH083520200012
ABITIG® 24W Little	4 m	DD	lorch - BSB / CG offen	High Flex Leder	7L9SH043520200012
	8 m	DD	lorch - BSB / CG offen	High Flex Leder	7L9SH083520200012
ABITIG® 450W	4 m	DD	lorch - BSB / CG offen	Standard	7T5SK043520200012
	8 m	DD	lorch - BSB / CG offen	Standard	7T5SK083520200012
	4 m	DD	lorch - BSB / CG offen	High Flex Leder	7T5SH043520200012
	8 m	DD	lorch - BSB / CG offen	High Flex Leder	7T5SH083520200012
ABITIG® 260W	4 m	DD	lorch - BSB / CG offen	Standard	7T7SK043520200012
	8 m	DD	lorch - BSB / CG offen	Standard	7T7SK083520200012
	4 m	DD	lorch - BSB / CG offen	High Flex Leder	7T7SH043520200012
	8 m	DD	lorch - BSB / CG offen	High Flex Leder	7T7SH083520200012
ABITIG® 260W Little	4 m	DD	lorch - BSB / CG offen	High Flex Leder	7L7SH043520200012
	8 m	DD	lorch - BSB / CG offen	High Flex Leder	7L7SH083520200012
ABITIG® 450W SC	4 m	DD	lorch - BSB / CG offen	Standard	
	8 m	DD	lorch - BSB / CG offen	Standard	
	4 m	DD	lorch - BSB / CG offen	High Flex Leder	7T8SH043520200012
	8 m	DD	lorch - BSB / CG offen	High Flex Leder	7T8SH083520200012

ABITIG® GRIP / ABITIG® GRIP Little-Brennerpreisliste

passend für WIG-Stromquellen des Fabrikates „lorch“

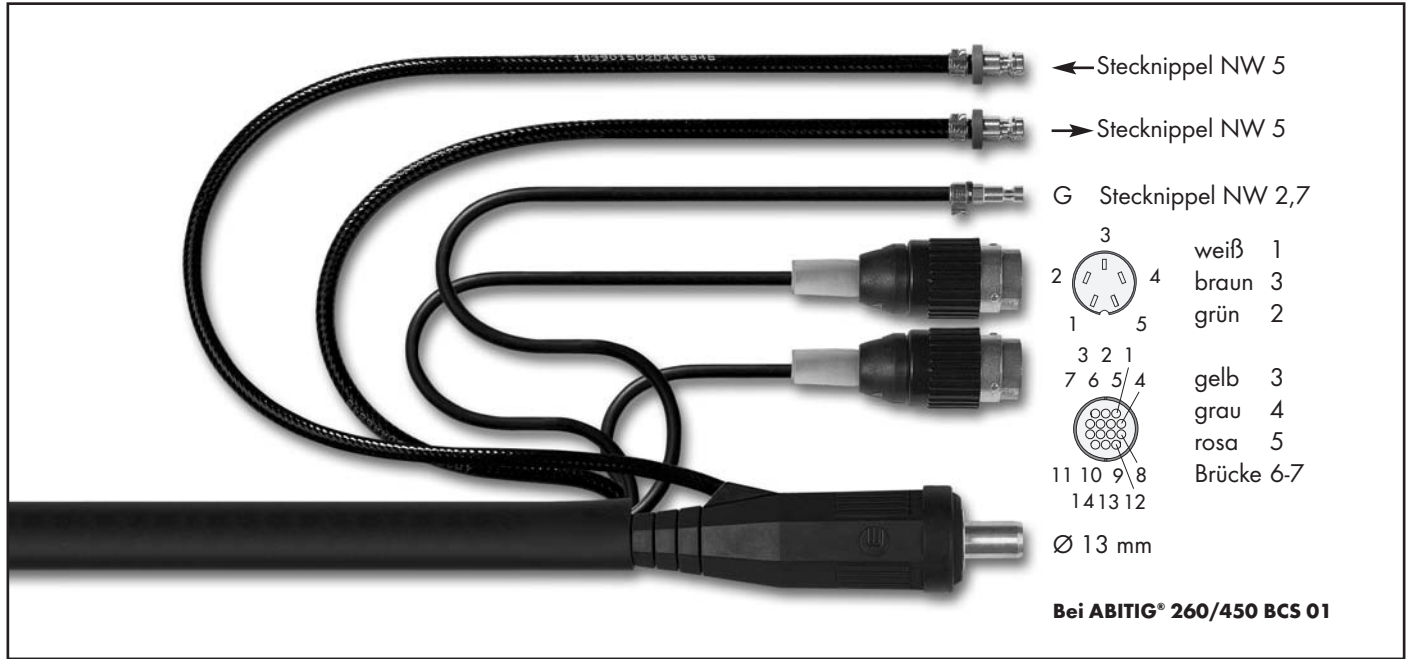

Brennertyp	Länge	Schalterfunktion	maschinenseitiger Anschluss	Schlauchpaketausführung	Bestellnummer
ABITIG® 18	4 m	DDP	BSB 35-50 Tuchel 5-pol.+ AMP 14-pol.	Standard	7S4SK046540036B16
	8 m	DDP	BSB 35-50 Tuchel 5-pol.+ AMP 14-pol.	Standard	7S4SK086540036B16
	4 m	DDP	BSB 35-50 Tuchel 5-pol.+ AMP 14-pol.	High Flex Leder	7S4SH046540036B16
	8 m	DDP	BSB 35-50 Tuchel 5-pol.+ AMP 14-pol.	High Flex Leder	7S4SH086540036B16
ABITIG® 18F	4 m	DDP	BSB 35-50 Tuchel 5-pol.+ AMP 14-pol.	Standard	7S4FK046540036B16
	8 m	DDP	BSB 35-50 Tuchel 5-pol.+ AMP 14-pol.	Standard	7S4FK086540036B16
	4 m	DDP	BSB 35-50 Tuchel 5-pol.+ AMP 14-pol.	High Flex Leder	7S4FH046540036B16
	8 m	DDP	BSB 35-50 Tuchel 5-pol.+ AMP 14-pol.	High Flex Leder	7S4FH086540036B16
ABITIG® 20	4 m	DDP	BSB 35-50 Tuchel 5-pol.+ AMP 14-pol.	Standard	7S5SK046540036B16
	8 m	DDP	BSB 35-50 Tuchel 5-pol.+ AMP 14-pol.	Standard	7S5SK086540036B16
	4 m	DDP	BSB 35-50 Tuchel 5-pol.+ AMP 14-pol.	High Flex Leder	7S5SH046540036B16
	8 m	DDP	BSB 35-50 Tuchel 5-pol.+ AMP 14-pol.	High Flex Leder	7S5SH086540036B16
ABITIG® 20F	4 m	DDP	BSB 35-50 Tuchel 5-pol.+ AMP 14-pol.	Standard	7S5FK046540036B16
	8 m	DDP	BSB 35-50 Tuchel 5-pol.+ AMP 14-pol.	Standard	7S5FK086540036B16
	4 m	DDP	BSB 35-50 Tuchel 5-pol.+ AMP 14-pol.	High Flex Leder	7S5FH046540036B16
	8 m	DDP	BSB 35-50 Tuchel 5-pol.+ AMP 14-pol.	High Flex Leder	7S5FH086540036B16

Technische Änderungen vorbehalten • Verkaufspreise = unverbindliche Preisempfehlung - Angebot freibleibend • © Copyright

ABITIG® GRIP / ABITIG® GRIP Little-Brennerpreisliste

passend für WIG-Stromquellen des Fabrikates „lorch“

Brennertyp	Länge	Schalterfunktion	maschinenseitiger Anschluss	Schlauchpaketausführung	Bestellnummer
ABITIG® 12-1	4 m	DDP	BSB 35-50 Tuchel 5-pol.+ AMP 14-pol.	Standard	7S6SK046540036B16
	8 m	DDP	BSB 35-50 Tuchel 5-pol.+ AMP 14-pol.	Standard	7S6SK086540036B16
	4 m	DDP	BSB 35-50 Tuchel 5-pol.+ AMP 14-pol.	High Flex Leder	7S6SH046540036B16
	8 m	DDP	BSB 35-50 Tuchel 5-pol.+ AMP 14-pol.	High Flex Leder	7S6SH086540036B16
ABITIG® 18SC	4 m	DDP	BSB 35-50 Tuchel 5-pol.+ AMP 14-pol.	Standard	7S7SK046540036B16
	8 m	DDP	BSB 35-50 Tuchel 5-pol.+ AMP 14-pol.	Standard	7S7SK086540036B16
	4 m	DDP	BSB 35-50 Tuchel 5-pol.+ AMP 14-pol.	High Flex Leder	7S7SH046540036B16
	8 m	DDP	BSB 35-50 Tuchel 5-pol.+ AMP 14-pol.	High Flex Leder	7S7SH086540036B16
ABITIG® 24W	4 m	DDP	BSB 35-50 Tuchel 5-pol.+ AMP 14-pol.	Standard	7S9SK046540036B16
	8 m	DDP	BSB 35-50 Tuchel 5-pol.+ AMP 14-pol.	Standard	7S9SK086540036B16
	4 m	DDP	BSB 35-50 Tuchel 5-pol.+ AMP 14-pol.	High Flex Leder	7S9SH046540036B16
	8 m	DDP	BSB 35-50 Tuchel 5-pol.+ AMP 14-pol.	High Flex Leder	7S9SH086540036B16
ABITIG® 450W	4 m	DDP	BSB 35-50 Tuchel 5-pol.+ AMP 14-pol.	Standard	7T5SK046540136B16
	8 m	DDP	BSB 35-50 Tuchel 5-pol.+ AMP 14-pol.	Standard	7T5SK086540136B16
	4 m	DDP	BSB 35-50 Tuchel 5-pol.+ AMP 14-pol.	High Flex Leder	7T5SH046540136B16
	8 m	DDP	BSB 35-50 Tuchel 5-pol.+ AMP 14-pol.	High Flex Leder	7T5SH086540136B16
ABITIG® 260W	4 m	DDP	BSB 35-50 Tuchel 5-pol.+ AMP 14-pol.	Standard	7T7SK046540136B16
	8 m	DDP	BSB 35-50 Tuchel 5-pol.+ AMP 14-pol.	Standard	7T7SK086540136B16
	4 m	DDP	BSB 35-50 Tuchel 5-pol.+ AMP 14-pol.	High Flex Leder	7T7SH046540136B16
	8 m	DDP	BSB 35-50 Tuchel 5-pol.+ AMP 14-pol.	High Flex Leder	7T7SH086540136B16
ABITIG® 450W SC	4 m	DDP	BSB 35-50 Tuchel 5-pol.+ AMP 14-pol.	Standard	
	8 m	DDP	BSB 35-50 Tuchel 5-pol.+ AMP 14-pol.	Standard	
	4 m	DDP	BSB 35-50 Tuchel 5-pol.+ AMP 14-pol.	High Flex Leder	7T8SH046540136B16
	8 m	DDP	BSB 35-50 Tuchel 5-pol.+ AMP 14-pol.	High Flex Leder	7T8SH086540136B16

ABITIG® GRIP / ABITIG® GRIP Little-Brennerpreisliste

passend für WIG-Stromquellen des Fabrikates „lorch“



Brennertyp	Länge	Schalterfunktion	maschinenseitiger Anschluss	Schlauchpaketausführung	Bestellnummer
ABITIG® 18	4m	UD	BSB 35-50 Tuchel 5-pol.	Standard	7S4SK046950051B16
	8m	UD	BSB 35-50 Tuchel 5-pol.	Standard	7S4SK086950051B16
	4m	UD	BSB 35-50 Tuchel 5-pol.	High Flex Leder	7S4SH046950051B16
	8m	UD	BSB 35-50 Tuchel 5-pol.	High Flex Leder	7S4SH086950051B16
ABITIG® 18F	4m	UD	BSB 35-50 Tuchel 5-pol.	Standard	7S4FK046950051B16
	8m	UD	BSB 35-50 Tuchel 5-pol.	Standard	7S4FK086950051B16
	4m	UD	BSB 35-50 Tuchel 5-pol.	High Flex Leder	7S4FH046950051B16
	8m	UD	BSB 35-50 Tuchel 5-pol.	High Flex Leder	7S4FH086950051B16
ABITIG® 20	4m	UD	BSB 35-50 Tuchel 5-pol.	Standard	7S5SK046950051B16
	8m	UD	BSB 35-50 Tuchel 5-pol.	Standard	7S5SK086950051B16
	4m	UD	BSB 35-50 Tuchel 5-pol.	High Flex Leder	7S5SH046950051B16
	8m	UD	BSB 35-50 Tuchel 5-pol.	High Flex Leder	7S5SH086950051B16
ABITIG® 20F	4m	UD	BSB 35-50 Tuchel 5-pol.	Standard	7S5FK046950051B16
	8m	UD	BSB 35-50 Tuchel 5-pol.	Standard	7S5FK086950051B16
	4m	UD	BSB 35-50 Tuchel 5-pol.	High Flex Leder	7S5FH046950051B16
	8m	UD	BSB 35-50 Tuchel 5-pol.	High Flex Leder	7S5FH086950051B16

ABITIG® GRIP / ABITIG® GRIP Little-Brennerpreisliste

passend für WIG-Stromquellen des Fabrikates „lorch“

Brennertyp	Länge	Schalterfunktion	maschinenseitiger Anschluss	Schlauchpaketausführung	Bestellnummer
ABITIG® 12-1	4m	UD	BSB 35-50 Tuchel 5-pol.	Standard	7S6SK046950051B16
	8m	UD	BSB 35-50 Tuchel 5-pol.	Standard	7S6SK086950051B16
	4m	UD	BSB 35-50 Tuchel 5-pol.	High Flex Leder	7S6SH046950051B16
	8m	UD	BSB 35-50 Tuchel 5-pol.	High Flex Leder	7S6SH086950051B16
ABITIG® 18SC	4m	UD	BSB 35-50 Tuchel 5-pol.	Standard	7S7SK046950051B16
	8m	UD	BSB 35-50 Tuchel 5-pol.	Standard	7S7SK086950051B16
	4m	UD	BSB 35-50 Tuchel 5-pol.	High Flex Leder	7S7SH046950051B16
	8m	UD	BSB 35-50 Tuchel 5-pol.	High Flex Leder	7S7SH086950051B16
ABITIG® 24W	4m	UD	BSB 35-50 Tuchel 5-pol.	Standard	7S9SK046950051B16
	8m	UD	BSB 35-50 Tuchel 5-pol.	Standard	7S9SK086950051B16
	4m	UD	BSB 35-50 Tuchel 5-pol.	High Flex Leder	7S9SH046950051B16
	8m	UD	BSB 35-50 Tuchel 5-pol.	High Flex Leder	7S9SH086950051B16
ABITIG® 450W	4m	UD	BSB 35-50 Tuchel 5-pol.	Standard	7T5SK046950151B16
	8m	UD	BSB 35-50 Tuchel 5-pol.	Standard	7T5SK086950151B16
	4m	UD	BSB 35-50 Tuchel 5-pol.	High Flex Leder	7T5SH046950151B16
	8m	UD	BSB 35-50 Tuchel 5-pol.	High Flex Leder	7T5SH086950151B16
ABITIG® 260W	4m	UD	BSB 35-50 Tuchel 5-pol.	Standard	7T7SK046950151B16
	8m	UD	BSB 35-50 Tuchel 5-pol.	Standard	7T7SK086950151B16
	4m	UD	BSB 35-50 Tuchel 5-pol.	High Flex Leder	7T7SH046950151B16
	8m	UD	BSB 35-50 Tuchel 5-pol.	High Flex Leder	7T7SH086950151B16
ABITIG® 450W SC	4m	UD	BSB 35-50 Tuchel 5-pol.	Standard	
	8m	UD	BSB 35-50 Tuchel 5-pol.	Standard	
	4m	UD	BSB 35-50 Tuchel 5-pol.	High Flex Leder	7T8SH046950151B16
	8m	UD	BSB 35-50 Tuchel 5-pol.	High Flex Leder	7T8SH086950151B16

ABITIG® GRIP / ABITIG® GRIP Little-Brennerpreisliste

passend für WIG-Stromquellen des Fabrikates „L-tec“



Brennertyp	Länge	Schalterfunktion	maschinenseitiger Anschluss	Schlauchpaketausführung	Bestellnummer
ABITIG® 9	4 m	DD	ZA - GZ Tuchel 5-pol.	Standard	7S1SK047520301C00
	8 m	DD	ZA - GZ Tuchel 5-pol.	Standard	7S1SK087520301C00
	4 m	DD	ZA - GZ Tuchel 5-pol.	High Flex Leder	7S1SH047520301C00
	8 m	DD	ZA - GZ Tuchel 5-pol.	High Flex Leder	7S1SH087520301C00
ABITIG® 9 Little	4 m	DD	ZA - GZ Tuchel 5-pol.	High Flex Leder	7L1SH047520301C00
	8 m	DD	ZA - GZ Tuchel 5-pol.	High Flex Leder	7L1SH087520301C00
ABITIG® 9F	4 m	DD	ZA - GZ Tuchel 5-pol.	Standard	7S1FK047520301C00
	8 m	DD	ZA - GZ Tuchel 5-pol.	Standard	7S1FK087520301C00
	4 m	DD	ZA - GZ Tuchel 5-pol.	High Flex Leder	7S1FH047520301C00
	8 m	DD	ZA - GZ Tuchel 5-pol.	High Flex Leder	7S1FH087520301C00
ABITIG® 9F Little	4 m	DD	ZA - GZ Tuchel 5-pol.	High Flex Leder	7L1FH047520301C00
	8 m	DD	ZA - GZ Tuchel 5-pol.	High Flex Leder	7L1FH087520301C00
ABITIG® 17	4 m	DD	ZA - GZ Tuchel 5-pol.	Standard	7S2SK047520301C00
	8 m	DD	ZA - GZ Tuchel 5-pol.	Standard	7S2SK087520301C00
	4 m	DD	ZA - GZ Tuchel 5-pol.	High Flex Leder	7S2SH047520301C00
	8 m	DD	ZA - GZ Tuchel 5-pol.	High Flex Leder	7S2SH087520301C00
ABITIG® 17 Little	4 m	DD	ZA - GZ Tuchel 5-pol.	High Flex Leder	7L2SH047520301C00
	8 m	DD	ZA - GZ Tuchel 5-pol.	High Flex Leder	7L2SH087520301C00
ABITIG® 17F	4 m	DD	ZA - GZ Tuchel 5-pol.	Standard	7S2FK047520301C00
	8 m	DD	ZA - GZ Tuchel 5-pol.	Standard	7S2FK087520301C00
	4 m	DD	ZA - GZ Tuchel 5-pol.	High Flex Leder	7S2FH047520301C00
	8 m	DD	ZA - GZ Tuchel 5-pol.	High Flex Leder	7S2FH087520301C00
ABITIG® 17F Little	4 m	DD	ZA - GZ Tuchel 5-pol.	High Flex Leder	7L2FH047520301C00
	8 m	DD	ZA - GZ Tuchel 5-pol.	High Flex Leder	7L2FH087520301C00

Technische Änderungen vorbehalten • Verkaufspreise = unverbindliche Preisempfehlung - Angebot freibleibend • © Copyright

ABITIG® GRIP / ABITIG® GRIP Little-Brennerpreisliste

passend für WIG-Stromquellen des Fabrikates „L-tec“

Brennertyp	Länge	Schalterfunktion	maschinenseitiger Anschluss	Schlauchpaketausführung	Bestellnummer
ABITIG® 26	4 m	DD	ZA - GZ Tuchel 5-pol.	Standard	7S3SK047520301C00
	8 m	DD	ZA - GZ Tuchel 5-pol.	Standard	7S3SK087520301C00
	4 m	DD	ZA - GZ Tuchel 5-pol.	High Flex Leder	7S3SH047520301C00
	8 m	DD	ZA - GZ Tuchel 5-pol.	High Flex Leder	7S3SH087520301C00
ABITIG® 26F	4 m	DD	ZA - GZ Tuchel 5-pol.	Standard	7S3FK047520301C00
	8 m	DD	ZA - GZ Tuchel 5-pol.	Standard	7S3FK087520301C00
	4 m	DD	ZA - GZ Tuchel 5-pol.	High Flex Leder	7S3FH047520301C00
	8 m	DD	ZA - GZ Tuchel 5-pol.	High Flex Leder	7S3FH087520301C00
ABITIG® 24G	4 m	DD	ZA - GZ Tuchel 5-pol.	Standard	7S8SK047520301C00
	8 m	DD	ZA - GZ Tuchel 5-pol.	Standard	7S8SK087520301C00
	4 m	DD	ZA - GZ Tuchel 5-pol.	High Flex Leder	7S8SH047520301C00
	8 m	DD	ZA - GZ Tuchel 5-pol.	High Flex Leder	7S8SH087520301C00
ABITIG® 24G Little	4 m	DD	ZA - GZ Tuchel 5-pol.	High Flex Leder	7L8SH047520301C00
	8 m	DD	ZA - GZ Tuchel 5-pol.	High Flex Leder	7L8SH087520301C00
ABITIG® 200	4 m	DD	ZA - GZ Tuchel 5-pol.	Standard	7T4SK047520301C00
	8 m	DD	ZA - GZ Tuchel 5-pol.	Standard	7T4SK087520301C00
	4 m	DD	ZA - GZ Tuchel 5-pol.	High Flex Leder	7T4SH047520301C00
	8 m	DD	ZA - GZ Tuchel 5-pol.	High Flex Leder	7T4SH087520301C00
ABITIG® 200F	4 m	DD	ZA - GZ Tuchel 5-pol.	Standard	7T4FK047520301C00
	8 m	DD	ZA - GZ Tuchel 5-pol.	Standard	7T4FK087520301C00
	4 m	DD	ZA - GZ Tuchel 5-pol.	High Flex Leder	7T4FH047520301C00
	8 m	DD	ZA - GZ Tuchel 5-pol.	High Flex Leder	7T4FH087520301C00
ABITIG® 150	4 m	DD	ZA - GZ Tuchel 5-pol.	Standard	7T6SK047520301C00
	8 m	DD	ZA - GZ Tuchel 5-pol.	Standard	7T6SK087520301C00
	4 m	DD	ZA - GZ Tuchel 5-pol.	High Flex Leder	7T6SH047520301C00
	8 m	DD	ZA - GZ Tuchel 5-pol.	High Flex Leder	7T6SH087520301C00
ABITIG® 150 Little	4 m	DD	ZA - GZ Tuchel 5-pol.	High Flex Leder	7L6SH047520301C00
	8 m	DD	ZA - GZ Tuchel 5-pol.	High Flex Leder	7L6SH087520301C00
ABITIG® 150F	4 m	DD	ZA - GZ Tuchel 5-pol.	Standard	7T6FK047520301C00
	8 m	DD	ZA - GZ Tuchel 5-pol.	Standard	7T6FK087520301C00
	4 m	DD	ZA - GZ Tuchel 5-pol.	High Flex Leder	7T6FH047520301C00
	8 m	DD	ZA - GZ Tuchel 5-pol.	High Flex Leder	7T6FH087520301C00
ABITIG® 150F Little	4 m	DD	ZA - GZ Tuchel 5-pol.	High Flex Leder	7L6FH047520301C00
	8 m	DD	ZA - GZ Tuchel 5-pol.	High Flex Leder	7L6FH087520301C00

ABITIG® GRIP / ABITIG® GRIP Little-Brennerpreisliste

passend für WIG-Stromquellen des Fabrikates „L-tec“



Brennertyp	Länge	Schalterfunktion	maschinenseitiger Anschluss	Schlauchpaketausführung	Bestellnummer
ABITIG® 9	4 m	ED	ZA - GZ Tuchel 5-pol.	Standard	7S1SK047510306A00
	8 m	ED	ZA - GZ Tuchel 5-pol.	Standard	7S1SK087510306A00
	4 m	ED	ZA - GZ Tuchel 5-pol.	High Flex Leder	7S1SH047510306A00
	8 m	ED	ZA - GZ Tuchel 5-pol.	High Flex Leder	7S1SH087510306A00
ABITIG® 9 Little	4 m	ED	ZA - GZ Tuchel 5-pol.	High Flex Leder	7L1SH047510306A00
	8 m	ED	ZA - GZ Tuchel 5-pol.	High Flex Leder	7L1SH087510306A00
ABITIG® 9F	4 m	ED	ZA - GZ Tuchel 5-pol.	Standard	7S1FK047510306A00
	8 m	ED	ZA - GZ Tuchel 5-pol.	Standard	7S1FK087510306A00
	4 m	ED	ZA - GZ Tuchel 5-pol.	High Flex Leder	7S1FH047510306A00
	8 m	ED	ZA - GZ Tuchel 5-pol.	High Flex Leder	7S1FH087510306A00
ABITIG® 9F Little	4 m	ED	ZA - GZ Tuchel 5-pol.	High Flex Leder	7L1FH047510306A00
	8 m	ED	ZA - GZ Tuchel 5-pol.	High Flex Leder	7L1FH087510306A00
ABITIG® 17	4 m	ED	ZA - GZ Tuchel 5-pol.	Standard	7S2SK047510306A00
	8 m	ED	ZA - GZ Tuchel 5-pol.	Standard	7S2SK087510306A00
	4 m	ED	ZA - GZ Tuchel 5-pol.	High Flex Leder	7S2SH047510306A00
	8 m	ED	ZA - GZ Tuchel 5-pol.	High Flex Leder	7S2SH087510306A00
ABITIG® 17 Little	4 m	ED	ZA - GZ Tuchel 5-pol.	High Flex Leder	7L2SH047510306A00
	8 m	ED	ZA - GZ Tuchel 5-pol.	High Flex Leder	7L2SH087510306A00
ABITIG® 17F	4 m	ED	ZA - GZ Tuchel 5-pol.	Standard	7S2FK047510306A00
	8 m	ED	ZA - GZ Tuchel 5-pol.	Standard	7S2FK087510306A00
	4 m	ED	ZA - GZ Tuchel 5-pol.	High Flex Leder	7S2FH047510306A00
	8 m	ED	ZA - GZ Tuchel 5-pol.	High Flex Leder	7S2FH087510306A00
ABITIG® 17F Little	4 m	ED	ZA - GZ Tuchel 5-pol.	High Flex Leder	7L2FH047510306A00
	8 m	ED	ZA - GZ Tuchel 5-pol.	High Flex Leder	7L2FH087510306A00

Technische Änderungen vorbehalten • Verkaufspreise = unverbindliche Preisempfehlung - Angebot freibleibend • © Copyright

ABITIG® GRIP / ABITIG® GRIP Little-Brennerpreisliste

passend für WIG-Stromquellen des Fabrikates „L-tec“

Brennertyp	Länge	Schalterfunktion	maschinenseitiger Anschluss	Schlauchpaketausführung	Bestellnummer
ABITIG® 26	4 m	ED	ZA - GZ Tuchel 5-pol.	Standard	7S3SK047510306A00
	8 m	ED	ZA - GZ Tuchel 5-pol.	Standard	7S3SK087510306A00
	4 m	ED	ZA - GZ Tuchel 5-pol.	High Flex Leder	7S3SH047510306A00
	8 m	ED	ZA - GZ Tuchel 5-pol.	High Flex Leder	7S3SH087510306A00
ABITIG® 26F	4 m	ED	ZA - GZ Tuchel 5-pol.	Standard	7S3FK047510306A00
	8 m	ED	ZA - GZ Tuchel 5-pol.	Standard	7S3FK087510306A00
	4 m	ED	ZA - GZ Tuchel 5-pol.	High Flex Leder	7S3FH047510306A00
	8 m	ED	ZA - GZ Tuchel 5-pol.	High Flex Leder	7S3FH087510306A00
ABITIG® 24G	4 m	ED	ZA - GZ Tuchel 5-pol.	Standard	7S8SK047510306A00
	8 m	ED	ZA - GZ Tuchel 5-pol.	Standard	7S8SK087510306A00
	4 m	ED	ZA - GZ Tuchel 5-pol.	High Flex Leder	7S8SH047510306A00
	8 m	ED	ZA - GZ Tuchel 5-pol.	High Flex Leder	7S8SH087510306A00
ABITIG® 24G Little	4 m	ED	ZA - GZ Tuchel 5-pol.	High Flex Leder	7L8SH047510306A00
	8 m	ED	ZA - GZ Tuchel 5-pol.	High Flex Leder	7L8SH087510306A00
ABITIG® 200	4 m	ED	ZA - GZ Tuchel 5-pol.	Standard	7T4SK047510306A00
	8 m	ED	ZA - GZ Tuchel 5-pol.	Standard	7T4SK087510306A00
	4 m	ED	ZA - GZ Tuchel 5-pol.	High Flex Leder	7T4SH047510306A00
	8 m	ED	ZA - GZ Tuchel 5-pol.	High Flex Leder	7T4SH087510306A00
ABITIG® 200F	4 m	ED	ZA - GZ Tuchel 5-pol.	Standard	7T4FK047510306A00
	8 m	ED	ZA - GZ Tuchel 5-pol.	Standard	7T4FK087510306A00
	4 m	ED	ZA - GZ Tuchel 5-pol.	High Flex Leder	7T4FH047510306A00
	8 m	ED	ZA - GZ Tuchel 5-pol.	High Flex Leder	7T4FH087510306A00
ABITIG® 150	4 m	ED	ZA - GZ Tuchel 5-pol.	Standard	7T6SK047510306A00
	8 m	ED	ZA - GZ Tuchel 5-pol.	Standard	7T6SK087510306A00
	4 m	ED	ZA - GZ Tuchel 5-pol.	High Flex Leder	7T6SH047510306A00
	8 m	ED	ZA - GZ Tuchel 5-pol.	High Flex Leder	7T6SH087510306A00
ABITIG® 150 Little	4 m	ED	ZA - GZ Tuchel 5-pol.	High Flex Leder	7L6SH047510306A00
	8 m	ED	ZA - GZ Tuchel 5-pol.	High Flex Leder	7L6SH087510306A00
ABITIG® 150F	4 m	ED	ZA - GZ Tuchel 5-pol.	Standard	7T6FK047510306A00
	8 m	ED	ZA - GZ Tuchel 5-pol.	Standard	7T6FK087510306A00
	4 m	ED	ZA - GZ Tuchel 5-pol.	High Flex Leder	7T6FH047510306A00
	8 m	ED	ZA - GZ Tuchel 5-pol.	High Flex Leder	7T6FH087510306A00
ABITIG® 150F Little	4 m	ED	ZA - GZ Tuchel 5-pol.	High Flex Leder	7L6FH047510306A00
	8 m	ED	ZA - GZ Tuchel 5-pol.	High Flex Leder	7L6FH087510306A00

ABITIG® GRIP / ABITIG® GRIP Little-Brennerpreisliste

passend für WIG-Stromquellen des Fabrikates „L-tec“



Brennertyp	Länge	Schalterfunktion	maschinenseitiger Anschluss	Schlauchpaketausführung	Bestellnummer
ABITIG® 18	4 m	DD	ZA - WZ-0 Tuchel 5-pol.	Standard	7S4SK047520302C12
	8 m	DD	ZA - WZ-0 Tuchel 5-pol.	Standard	7S4SK087520302C12
	4 m	DD	ZA - WZ-0 Tuchel 5-pol.	High Flex Leder	7S4SH047520302C12
	8 m	DD	ZA - WZ-0 Tuchel 5-pol.	High Flex Leder	7S4SH087520302C12
ABITIG® 18F	4 m	DD	ZA - WZ-0 Tuchel 5-pol.	Standard	7S4FK047520302C12
	8 m	DD	ZA - WZ-0 Tuchel 5-pol.	Standard	7S4FK087520302C12
	4 m	DD	ZA - WZ-0 Tuchel 5-pol.	High Flex Leder	7S4FH047520302C12
	8 m	DD	ZA - WZ-0 Tuchel 5-pol.	High Flex Leder	7S4FH087520302C12
ABITIG® 20	4 m	DD	ZA - WZ-0 Tuchel 5-pol.	Standard	7S5SK047520302C12
	8 m	DD	ZA - WZ-0 Tuchel 5-pol.	Standard	7S5SK087520302C12
	4 m	DD	ZA - WZ-0 Tuchel 5-pol.	High Flex Leder	7S5SH047520302C12
	8 m	DD	ZA - WZ-0 Tuchel 5-pol.	High Flex Leder	7S5SH087520302C12
ABITIG® 20 Little	4 m	DD	ZA - WZ-0 Tuchel 5-pol.	High Flex Leder	7L5SH047520302C12
	8 m	DD	ZA - WZ-0 Tuchel 5-pol.	High Flex Leder	7L5SH087520302C12
ABITIG® 20F	4 m	DD	ZA - WZ-0 Tuchel 5-pol.	Standard	7S5FK047520302C12
	8 m	DD	ZA - WZ-0 Tuchel 5-pol.	Standard	7S5FK087520302C12
	4 m	DD	ZA - WZ-0 Tuchel 5-pol.	High Flex Leder	7S5FH047520302C12
	8 m	DD	ZA - WZ-0 Tuchel 5-pol.	High Flex Leder	7S5FH087520302C12
ABITIG® 20F Little	4 m	DD	ZA - WZ-0 Tuchel 5-pol.	High Flex Leder	7L5FH047520302C12
	8 m	DD	ZA - WZ-0 Tuchel 5-pol.	High Flex Leder	7L5FH087520302C12

Technische Änderungen vorbehalten • Verkaufspreise = unverbindliche Preisempfehlung - Angebot freibleibend • © Copyright

ABITIG® GRIP / ABITIG® GRIP Little-Brennerpreisliste

passend für WIG-Stromquellen des Fabrikates „L-tec“

Brennertyp	Länge	Schalterfunktion	maschinenseitiger Anschluss	Schlauchpaketausführung	Bestellnummer
ABITIG® 12-1	4 m	DD	ZA - WZ-0 Tuchel 5-pol.	Standard	7S6SK047520302C12
	8 m	DD	ZA - WZ-0 Tuchel 5-pol.	Standard	7S6SK087520302C12
	4 m	DD	ZA - WZ-0 Tuchel 5-pol.	High Flex Leder	7S6SH047520302C12
	8 m	DD	ZA - WZ-0 Tuchel 5-pol.	High Flex Leder	7S6SH087520302C12
<hr/>					
ABITIG® 18SC	4 m	DD	ZA - WZ-0 Tuchel 5-pol.	Standard	7S7SK047520302C12
	8 m	DD	ZA - WZ-0 Tuchel 5-pol.	Standard	7S7SK087520302C12
	4 m	DD	ZA - WZ-0 Tuchel 5-pol.	High Flex Leder	7S7SH047520302C12
	8 m	DD	ZA - WZ-0 Tuchel 5-pol.	High Flex Leder	7S7SH087520302C12
<hr/>					
ABITIG® 24W	4 m	DD	ZA - WZ-0 Tuchel 5-pol.	Standard	7S9SK047520302C12
	8 m	DD	ZA - WZ-0 Tuchel 5-pol.	Standard	7S9SK087520302C12
	4 m	DD	ZA - WZ-0 Tuchel 5-pol.	High Flex Leder	7S9SH047520302C12
	8 m	DD	ZA - WZ-0 Tuchel 5-pol.	High Flex Leder	7S9SH087520302C12
ABITIG® 24W Little	4 m	DD	ZA - WZ-0 Tuchel 5-pol.	High Flex Leder	7L9SH047520302C12
	8 m	DD	ZA - WZ-0 Tuchel 5-pol.	High Flex Leder	7L9SH087520302C12
<hr/>					
ABITIG® 450W	4 m	DD	ZA - WZ-0 Tuchel 5-pol.	Standard	7T5SK047520302C12
	8 m	DD	ZA - WZ-0 Tuchel 5-pol.	Standard	7T5SK087520302C12
	4 m	DD	ZA - WZ-0 Tuchel 5-pol.	High Flex Leder	7T5SH047520302C12
	8 m	DD	ZA - WZ-0 Tuchel 5-pol.	High Flex Leder	7T5SH087520302C12
<hr/>					
ABITIG® 260W	4 m	DD	ZA - WZ-0 Tuchel 5-pol.	Standard	7T7SK047520302C12
	8 m	DD	ZA - WZ-0 Tuchel 5-pol.	Standard	7T7SK087520302C12
	4 m	DD	ZA - WZ-0 Tuchel 5-pol.	High Flex Leder	7T7SH047520302C12
	8 m	DD	ZA - WZ-0 Tuchel 5-pol.	High Flex Leder	7T7SH087520302C12
ABITIG® 260W Little	4 m	DD	ZA - WZ-0 Tuchel 5-pol.	High Flex Leder	7L7SH047520302C12
	8 m	DD	ZA - WZ-0 Tuchel 5-pol.	High Flex Leder	7L7SH087520302C12
<hr/>					
ABITIG® 450W SC	4 m	DD	ZA - WZ-0 Tuchel 5-pol.	Standard	
	8 m	DD	ZA - WZ-0 Tuchel 5-pol.	Standard	
	4 m	DD	ZA - WZ-0 Tuchel 5-pol.	High Flex Leder	7T8SH047520302C12
	8 m	DD	ZA - WZ-0 Tuchel 5-pol.	High Flex Leder	7T8SH087520302C12

ABITIG® GRIP / ABITIG® GRIP Little-Brennerpreisliste

passend für WIG-Stromquellen des Fabrikates „L-tec“



Brennertyp	Länge	Schalterfunktion	maschinenseitiger Anschluss	Schlauchpaketausführung	Bestellnummer
ABITIG® 18	4 m	ED	ZA - WZ-0 Tuchel 5-pol.	Standard	7S4SK047510302A12
	8 m	ED	ZA - WZ-0 Tuchel 5-pol.	Standard	7S4SK087510302A12
	4 m	ED	ZA - WZ-0 Tuchel 5-pol.	High Flex Leder	7S4SH047510302A12
	8 m	ED	ZA - WZ-0 Tuchel 5-pol.	High Flex Leder	7S4SH087510302A12
ABITIG® 18F	4 m	ED	ZA - WZ-0 Tuchel 5-pol.	Standard	7S4FK047510302A12
	8 m	ED	ZA - WZ-0 Tuchel 5-pol.	Standard	7S4FK087510302A12
	4 m	ED	ZA - WZ-0 Tuchel 5-pol.	High Flex Leder	7S4FH047510302A12
	8 m	ED	ZA - WZ-0 Tuchel 5-pol.	High Flex Leder	7S4FH087510302A12
ABITIG® 20	4 m	ED	ZA - WZ-0 Tuchel 5-pol.	Standard	7S5SK047510302A12
	8 m	ED	ZA - WZ-0 Tuchel 5-pol.	Standard	7S5SK087510302A12
	4 m	ED	ZA - WZ-0 Tuchel 5-pol.	High Flex Leder	7S5SH047510302A12
	8 m	ED	ZA - WZ-0 Tuchel 5-pol.	High Flex Leder	7S5SH087510302A12
ABITIG® 20 Little	4 m	ED	ZA - WZ-0 Tuchel 5-pol.	High Flex Leder	7L5SH047510302A12
	8 m	ED	ZA - WZ-0 Tuchel 5-pol.	High Flex Leder	7L5SH087510302A12
ABITIG® 20F	4 m	ED	ZA - WZ-0 Tuchel 5-pol.	Standard	7S5FK047510302A12
	8 m	ED	ZA - WZ-0 Tuchel 5-pol.	Standard	7S5FK087510302A12
	4 m	ED	ZA - WZ-0 Tuchel 5-pol.	High Flex Leder	7S5FH047510302A12
	8 m	ED	ZA - WZ-0 Tuchel 5-pol.	High Flex Leder	7S5FH087510302A12
ABITIG® 20F Little	4 m	ED	ZA - WZ-0 Tuchel 5-pol.	High Flex Leder	7L5FH047510302A12
	8 m	ED	ZA - WZ-0 Tuchel 5-pol.	High Flex Leder	7L5FH087510302A12

Technische Änderungen vorbehalten • Verkaufspreise = unverbindliche Preisempfehlung - Angebot freibleibend • © Copyright

ABITIG® GRIP / ABITIG® GRIP Little-Brennerpreisliste

passend für WIG-Stromquellen des Fabrikates „L-tec“

Brennertyp	Länge	Schalterfunktion	maschinenseitiger Anschluss	Schlauchpaketausführung	Bestellnummer
ABITIG® 12-1	4 m	ED	ZA - WZ-0 Tuchel 5-pol.	Standard	7S6SK047520302A12
	8 m	ED	ZA - WZ-0 Tuchel 5-pol.	Standard	7S6SK087520302A12
	4 m	ED	ZA - WZ-0 Tuchel 5-pol.	High Flex Leder	7S6SH047520302A12
	8 m	ED	ZA - WZ-0 Tuchel 5-pol.	High Flex Leder	7S6SH087520302A12
<hr/>					
ABITIG® 18SC	4 m	ED	ZA - WZ-0 Tuchel 5-pol.	Standard	7S7SK047520302A12
	8 m	ED	ZA - WZ-0 Tuchel 5-pol.	Standard	7S7SK087520302A12
	4 m	ED	ZA - WZ-0 Tuchel 5-pol.	High Flex Leder	7S7SH047520302A12
	8 m	ED	ZA - WZ-0 Tuchel 5-pol.	High Flex Leder	7S7SH087520302A12
<hr/>					
ABITIG® 24W	4 m	ED	ZA - WZ-0 Tuchel 5-pol.	Standard	7S9SK047520302A12
	8 m	ED	ZA - WZ-0 Tuchel 5-pol.	Standard	7S9SK087520302A12
	4 m	ED	ZA - WZ-0 Tuchel 5-pol.	High Flex Leder	7S9SH047520302A12
	8 m	ED	ZA - WZ-0 Tuchel 5-pol.	High Flex Leder	7S9SH087520302A12
ABITIG® 24W Little	4 m	ED	ZA - WZ-0 Tuchel 5-pol.	High Flex Leder	7L9SH047520302A12
	8 m	ED	ZA - WZ-0 Tuchel 5-pol.	High Flex Leder	7L9SH087520302A12
<hr/>					
ABITIG® 450W	4 m	ED	ZA - WZ-0 Tuchel 5-pol.	Standard	7T5SK047520302A12
	8 m	ED	ZA - WZ-0 Tuchel 5-pol.	Standard	7T5SK087520302A12
	4 m	ED	ZA - WZ-0 Tuchel 5-pol.	High Flex Leder	7T5SH047520302A12
	8 m	ED	ZA - WZ-0 Tuchel 5-pol.	High Flex Leder	7T5SH087520302A12
<hr/>					
ABITIG® 260W	4 m	ED	ZA - WZ-0 Tuchel 5-pol.	Standard	7T7SK047520302A12
	8 m	ED	ZA - WZ-0 Tuchel 5-pol.	Standard	7T7SK087520302A12
	4 m	ED	ZA - WZ-0 Tuchel 5-pol.	High Flex Leder	7T7SH047520302A12
	8 m	ED	ZA - WZ-0 Tuchel 5-pol.	High Flex Leder	7T7SH087520302A12
ABITIG® 260W Little	4 m	ED	ZA - WZ-0 Tuchel 5-pol.	High Flex Leder	7L7SH047520302A12
	8 m	ED	ZA - WZ-0 Tuchel 5-pol.	High Flex Leder	7L7SH087520302A12
<hr/>					
ABITIG® 450W SC	4 m	ED	ZA - WZ-0 Tuchel 5-pol.	Standard	
	8 m	ED	ZA - WZ-0 Tuchel 5-pol.	Standard	
	4 m	ED	ZA - WZ-0 Tuchel 5-pol.	High Flex Leder	7T8SH047520302A12
	8 m	ED	ZA - WZ-0 Tuchel 5-pol.	High Flex Leder	7T8SH087520302A12

ABITIG® GRIP / ABITIG® GRIP Little-Brennerpreisliste

passend für WIG-Stromquellen des Fabrikates „mahe“



Brennertyp	Länge	Schalterfunktion	maschinenseitiger Anschluss	Schlauchpaketausführung	Bestellnummer
ABITIG® 9	4 m	ED	BSB 35-50 Tuchel 5-pol.	Standard	7S1SK043510060A01
	8 m	ED	BSB 35-50 Tuchel 5-pol.	Standard	7S1SK083510060A01
	4 m	ED	BSB 35-50 Tuchel 5-pol.	High Flex Leder	7S1SH043510060A01
	8 m	ED	BSB 35-50 Tuchel 5-pol.	High Flex Leder	7S1SH083510060A01
ABITIG® 9 Little	4 m	ED	BSB 35-50 Tuchel 5-pol.	High Flex Leder	7L1SH043510060A01
	8 m	ED	BSB 35-50 Tuchel 5-pol.	High Flex Leder	7L1SH083510060A01
ABITIG® 9F	4 m	ED	BSB 35-50 Tuchel 5-pol.	Standard	7S1FK043510060A01
	8 m	ED	BSB 35-50 Tuchel 5-pol.	Standard	7S1FK083510060A01
	4 m	ED	BSB 35-50 Tuchel 5-pol.	High Flex Leder	7S1FH043510060A01
	8 m	ED	BSB 35-50 Tuchel 5-pol.	High Flex Leder	7S1FH083510060A01
ABITIG® 9F Little	4 m	ED	BSB 35-50 Tuchel 5-pol.	High Flex Leder	7L1FH043510060A01
	8 m	ED	BSB 35-50 Tuchel 5-pol.	High Flex Leder	7L1FH083510060A01
ABITIG® 17	4 m	ED	BSB 35-50 Tuchel 5-pol.	Standard	7S2SK043510060A01
	8 m	ED	BSB 35-50 Tuchel 5-pol.	Standard	7S2SK083510060A01
	4 m	ED	BSB 35-50 Tuchel 5-pol.	High Flex Leder	7S2SH043510060A01
	8 m	ED	BSB 35-50 Tuchel 5-pol.	High Flex Leder	7S2SH083510060A01
ABITIG® 17 Little	4 m	ED	BSB 35-50 Tuchel 5-pol.	High Flex Leder	7L2SH043510060A01
	8 m	ED	BSB 35-50 Tuchel 5-pol.	High Flex Leder	7L2SH083510060A01
ABITIG® 17F	4 m	ED	BSB 35-50 Tuchel 5-pol.	Standard	7S2FK043510060A01
	8 m	ED	BSB 35-50 Tuchel 5-pol.	Standard	7S2FK083510060A01
	4 m	ED	BSB 35-50 Tuchel 5-pol.	High Flex Leder	7S2FH043510060A01
	8 m	ED	BSB 35-50 Tuchel 5-pol.	High Flex Leder	7S2FH083510060A01
ABITIG® 17F Little	4 m	ED	BSB 35-50 Tuchel 5-pol.	High Flex Leder	7L2FH043510060A01
	8 m	ED	BSB 35-50 Tuchel 5-pol.	High Flex Leder	7L2FH083510060A01

Technische Änderungen vorbehalten • Verkaufspreise = unverbindliche Preisempfehlung - Angebot freibleibend • © Copyright

ABITIG® GRIP / ABITIG® GRIP Little-Brennerpreisliste

passend für WIG-Stromquellen des Fabrikates „mahe“

Brennertyp	Länge	Schalterfunktion	maschinenseitiger Anschluss	Schlauchpaketausführung	Bestellnummer
ABITIG® 26	4 m	ED	BSB 35-50 Tuchel 5-pol.	Standard	7S3SK043510060A01
	8 m	ED	BSB 35-50 Tuchel 5-pol.	Standard	7S3SK083510060A01
	4 m	ED	BSB 35-50 Tuchel 5-pol.	High Flex Leder	7S3SH043510060A01
	8 m	ED	BSB 35-50 Tuchel 5-pol.	High Flex Leder	7S3SH083510060A01
ABITIG® 26F	4 m	ED	BSB 35-50 Tuchel 5-pol.	Standard	7S3FK043510060A01
	8 m	ED	BSB 35-50 Tuchel 5-pol.	Standard	7S3FK083510060A01
	4 m	ED	BSB 35-50 Tuchel 5-pol.	High Flex Leder	7S3FH043510060A01
	8 m	ED	BSB 35-50 Tuchel 5-pol.	High Flex Leder	7S3FH083510060A01
ABITIG® 24G	4 m	ED	BSB 35-50 Tuchel 5-pol.	Standard	7S8SK043510060A01
	8 m	ED	BSB 35-50 Tuchel 5-pol.	Standard	7S8SK083510060A01
	4 m	ED	BSB 35-50 Tuchel 5-pol.	High Flex Leder	7S8SH043510060A01
	8 m	ED	BSB 35-50 Tuchel 5-pol.	High Flex Leder	7S8SH083510060A01
ABITIG® 24G Little	4 m	ED	BSB 35-50 Tuchel 5-pol.	High Flex Leder	7L8SH043510060A01
	8 m	ED	BSB 35-50 Tuchel 5-pol.	High Flex Leder	7L8SH083510060A01
ABITIG® 200	4 m	ED	BSB 35-50 Tuchel 5-pol.	Standard	7T4SK043510060A01
	8 m	ED	BSB 35-50 Tuchel 5-pol.	Standard	7T4SK083510060A01
	4 m	ED	BSB 35-50 Tuchel 5-pol.	High Flex Leder	7T4SH043510060A01
	8 m	ED	BSB 35-50 Tuchel 5-pol.	High Flex Leder	7T4SH083510060A01
ABITIG® 200F	4 m	ED	BSB 35-50 Tuchel 5-pol.	Standard	7T4FK043510060A01
	8 m	ED	BSB 35-50 Tuchel 5-pol.	Standard	7T4FK083510060A01
	4 m	ED	BSB 35-50 Tuchel 5-pol.	High Flex Leder	7T4FH043510060A01
	8 m	ED	BSB 35-50 Tuchel 5-pol.	High Flex Leder	7T4FH083510060A01
ABITIG® 150	4 m	ED	BSB 35-50 Tuchel 5-pol.	Standard	7T6SK043510060A01
	8 m	ED	BSB 35-50 Tuchel 5-pol.	Standard	7T6SK083510060A01
	4 m	ED	BSB 35-50 Tuchel 5-pol.	High Flex Leder	7T6SH043510060A01
	8 m	ED	BSB 35-50 Tuchel 5-pol.	High Flex Leder	7T6SH083510060A01
ABITIG® 150 Little	4 m	ED	BSB 35-50 Tuchel 5-pol.	High Flex Leder	7L6SH043510060A01
	8 m	ED	BSB 35-50 Tuchel 5-pol.	High Flex Leder	7L6SH083510060A01
ABITIG® 150F	4 m	ED	BSB 35-50 Tuchel 5-pol.	Standard	7T6FK043510060A01
	8 m	ED	BSB 35-50 Tuchel 5-pol.	Standard	7T6FK083510060A01
	4 m	ED	BSB 35-50 Tuchel 5-pol.	High Flex Leder	7T6FH043510060A01
	8 m	ED	BSB 35-50 Tuchel 5-pol.	High Flex Leder	7T6FH083510060A01
ABITIG® 150F Little	4 m	ED	BSB 35-50 Tuchel 5-pol.	High Flex Leder	7L6FH043510060A01
	8 m	ED	BSB 35-50 Tuchel 5-pol.	High Flex Leder	7L6FH083510060A01

ABITIG® GRIP / ABITIG® GRIP Little-Brennerpreisliste

passend für WIG-Stromquellen des Fabrikates „mahe“



Brennertyp	Länge	Schalterfunktion	maschinenseitiger Anschluss	Schlauchpaketausführung	Bestellnummer
ABITIG® 9	4 m	DD	BSB 35-50 Tuchel 5-pol.	Standard	7S1SK043520060C01
	8 m	DD	BSB 35-50 Tuchel 5-pol.	Standard	7S1SK083520060C01
	4 m	DD	BSB 35-50 Tuchel 5-pol.	High Flex Leder	7S1SH043520060C01
	8 m	DD	BSB 35-50 Tuchel 5-pol.	High Flex Leder	7S1SH083520060C01
ABITIG® 9 Little	4 m	DD	BSB 35-50 Tuchel 5-pol.	High Flex Leder	7L1SH043520060C01
	8 m	DD	BSB 35-50 Tuchel 5-pol.	High Flex Leder	7L1SH083520060C01
ABITIG® 9F	4 m	DD	BSB 35-50 Tuchel 5-pol.	Standard	7S1FK043520060C01
	8 m	DD	BSB 35-50 Tuchel 5-pol.	Standard	7S1FK083520060C01
	4 m	DD	BSB 35-50 Tuchel 5-pol.	High Flex Leder	7S1FH043520060C01
	8 m	DD	BSB 35-50 Tuchel 5-pol.	High Flex Leder	7S1FH083520060C01
ABITIG® 9F Little	4 m	DD	BSB 35-50 Tuchel 5-pol.	High Flex Leder	7L1FH043520060C01
	8 m	DD	BSB 35-50 Tuchel 5-pol.	High Flex Leder	7L1FH083520060C01
ABITIG® 17	4 m	DD	BSB 35-50 Tuchel 5-pol.	Standard	7S2SK043520060C01
	8 m	DD	BSB 35-50 Tuchel 5-pol.	Standard	7S2SK083520060C01
	4 m	DD	BSB 35-50 Tuchel 5-pol.	High Flex Leder	7S2SH043520060C01
	8 m	DD	BSB 35-50 Tuchel 5-pol.	High Flex Leder	7S2SH083520060C01
ABITIG® 17 Little	4 m	DD	BSB 35-50 Tuchel 5-pol.	High Flex Leder	7L2SH043520060C01
	8 m	DD	BSB 35-50 Tuchel 5-pol.	High Flex Leder	7L2SH083520060C01
ABITIG® 17F	4 m	DD	BSB 35-50 Tuchel 5-pol.	Standard	7S2FK043520060C01
	8 m	DD	BSB 35-50 Tuchel 5-pol.	Standard	7S2FK083520060C01
	4 m	DD	BSB 35-50 Tuchel 5-pol.	High Flex Leder	7S2FH043520060C01
	8 m	DD	BSB 35-50 Tuchel 5-pol.	High Flex Leder	7S2FH083520060C01
ABITIG® 17F Little	4 m	DD	BSB 35-50 Tuchel 5-pol.	High Flex Leder	7L2FH043520060C01
	8 m	DD	BSB 35-50 Tuchel 5-pol.	High Flex Leder	7L2FH083520060C01

Technische Änderungen vorbehalten • Verkaufspreise = unverbindliche Preisempfehlung - Angebot freibleibend • © Copyright

ABITIG® GRIP / ABITIG® GRIP Little-Brennerpreisliste

passend für WIG-Stromquellen des Fabrikates „mahe“

Brennertyp	Länge	Schalterfunktion	maschinenseitiger Anschluss	Schlauchpaketausführung	Bestellnummer
ABITIG® 26	4 m	DD	BSB 35-50 Tuchel 5-pol.	Standard	7S3SK043520060C01
	8 m	DD	BSB 35-50 Tuchel 5-pol.	Standard	7S3SK083520060C01
	4 m	DD	BSB 35-50 Tuchel 5-pol.	High Flex Leder	7S3SH043520060C01
	8 m	DD	BSB 35-50 Tuchel 5-pol.	High Flex Leder	7S3SH083520060C01
ABITIG® 26F	4 m	DD	BSB 35-50 Tuchel 5-pol.	Standard	7S3FK043520060C01
	8 m	DD	BSB 35-50 Tuchel 5-pol.	Standard	7S3FK083520060C01
	4 m	DD	BSB 35-50 Tuchel 5-pol.	High Flex Leder	7S3FH043520060C01
	8 m	DD	BSB 35-50 Tuchel 5-pol.	High Flex Leder	7S3FH083520060C01
ABITIG® 24G	4 m	DD	BSB 35-50 Tuchel 5-pol.	Standard	7S8SK043520060C01
	8 m	DD	BSB 35-50 Tuchel 5-pol.	Standard	7S8SK083520060C01
	4 m	DD	BSB 35-50 Tuchel 5-pol.	High Flex Leder	7S8SH043520060C01
	8 m	DD	BSB 35-50 Tuchel 5-pol.	High Flex Leder	7S8SH083520060C01
ABITIG® 24G Little	4 m	DD	BSB 35-50 Tuchel 5-pol.	High Flex Leder	7L8SH043520060C01
	8 m	DD	BSB 35-50 Tuchel 5-pol.	High Flex Leder	7L8SH083520060C01
ABITIG® 200	4 m	DD	BSB 35-50 Tuchel 5-pol.	Standard	7T4SK043520060C01
	8 m	DD	BSB 35-50 Tuchel 5-pol.	Standard	7T4SK083520060C01
	4 m	DD	BSB 35-50 Tuchel 5-pol.	High Flex Leder	7T4SH043520060C01
	8 m	DD	BSB 35-50 Tuchel 5-pol.	High Flex Leder	7T4SH083520060C01
ABITIG® 200F	4 m	DD	BSB 35-50 Tuchel 5-pol.	Standard	7T4FK043520060C01
	8 m	DD	BSB 35-50 Tuchel 5-pol.	Standard	7T4FK083520060C01
	4 m	DD	BSB 35-50 Tuchel 5-pol.	High Flex Leder	7T4FH043520060C01
	8 m	DD	BSB 35-50 Tuchel 5-pol.	High Flex Leder	7T4FH083520060C01
ABITIG® 150	4 m	DD	BSB 35-50 Tuchel 5-pol.	Standard	7T6SK043520060C01
	8 m	DD	BSB 35-50 Tuchel 5-pol.	Standard	7T6SK083520060C01
	4 m	DD	BSB 35-50 Tuchel 5-pol.	High Flex Leder	7T6SH043520060C01
	8 m	DD	BSB 35-50 Tuchel 5-pol.	High Flex Leder	7T6SH083520060C01
ABITIG® 150 Little	4 m	DD	BSB 35-50 Tuchel 5-pol.	High Flex Leder	7L6SH043520060C01
	8 m	DD	BSB 35-50 Tuchel 5-pol.	High Flex Leder	7L6SH083520060C01
ABITIG® 150F	4 m	DD	BSB 35-50 Tuchel 5-pol.	Standard	7T6FK043520060C01
	8 m	DD	BSB 35-50 Tuchel 5-pol.	Standard	7T6FK083520060C01
	4 m	DD	BSB 35-50 Tuchel 5-pol.	High Flex Leder	7T6FH043520060C01
	8 m	DD	BSB 35-50 Tuchel 5-pol.	High Flex Leder	7T6FH083520060C01
ABITIG® 150F Little	4 m	DD	BSB 35-50 Tuchel 5-pol.	High Flex Leder	7L6FH043520060C01
	8 m	DD	BSB 35-50 Tuchel 5-pol.	High Flex Leder	7L6FH083520060C01

ABITIG® GRIP / ABITIG® GRIP Little-Brennerpreisliste

passend für WIG-Stromquellen des Fabrikates „mahe“



Brennertyp	Länge	Schalterfunktion	maschinenseitiger Anschluss	Schlauchpaketausführung	Bestellnummer
ABITIG® 9	4 m	EDP	BSB 35-50 Tuchel 5-pol.	Standard	7S1SK046540060B01
	8 m	EDP	BSB 35-50 Tuchel 5-pol.	Standard	7S1SK086540060B01
	4 m	EDP	BSB 35-50 Tuchel 5-pol.	High Flex Leder	7S1SH046540060B01
	8 m	EDP	BSB 35-50 Tuchel 5-pol.	High Flex Leder	7S1SH086540060B01
ABITIG® 9F	4 m	EDP	BSB 35-50 Tuchel 5-pol.	Standard	7S1FK046540060B01
	8 m	EDP	BSB 35-50 Tuchel 5-pol.	Standard	7S1FK086540060B01
	4 m	EDP	BSB 35-50 Tuchel 5-pol.	High Flex Leder	7S1FH046540060B01
	8 m	EDP	BSB 35-50 Tuchel 5-pol.	High Flex Leder	7S1FH086540060B01
ABITIG® 17	4 m	EDP	BSB 35-50 Tuchel 5-pol.	Standard	7S2SK046540060B01
	8 m	EDP	BSB 35-50 Tuchel 5-pol.	Standard	7S2SK086540060B01
	4 m	EDP	BSB 35-50 Tuchel 5-pol.	High Flex Leder	7S2SH046540060B01
	8 m	EDP	BSB 35-50 Tuchel 5-pol.	High Flex Leder	7S2SH086540060B01
ABITIG® 17F	4 m	EDP	BSB 35-50 Tuchel 5-pol.	Standard	7S2FK046540060B01
	8 m	EDP	BSB 35-50 Tuchel 5-pol.	Standard	7S2FK086540060B01
	4 m	EDP	BSB 35-50 Tuchel 5-pol.	High Flex Leder	7S2FH046540060B01
	8 m	EDP	BSB 35-50 Tuchel 5-pol.	High Flex Leder	7S2FH086540060B01

Technische Änderungen vorbehalten • Verkaufspreise = unverbindliche Preisempfehlung - Angebot freibleibend • © Copyright

ABITIG® GRIP / ABITIG® GRIP Little-Brennerpreisliste

passend für WIG-Stromquellen des Fabrikates „mahe“

Brennertyp	Länge	Schalterfunktion	maschinenseitiger Anschluss	Schlauchpaketausführung	Bestellnummer
ABITIG® 26	4 m	EDP	BSB 35-50 Tuchel 5-pol.	Standard	7S3SK046540060B01
	8 m	EDP	BSB 35-50 Tuchel 5-pol.	Standard	7S3SK086540060B01
	4 m	EDP	BSB 35-50 Tuchel 5-pol.	High Flex Leder	7S3SH046540060B01
	8 m	EDP	BSB 35-50 Tuchel 5-pol.	High Flex Leder	7S3SH086540060B01
ABITIG® 26F	4 m	EDP	BSB 35-50 Tuchel 5-pol.	Standard	7S3FK046540060B01
	8 m	EDP	BSB 35-50 Tuchel 5-pol.	Standard	7S3FK086540060B01
	4 m	EDP	BSB 35-50 Tuchel 5-pol.	High Flex Leder	7S3FH046540060B01
	8 m	EDP	BSB 35-50 Tuchel 5-pol.	High Flex Leder	7S3FH086540060B01
ABITIG® 24G	4 m	EDP	BSB 35-50 Tuchel 5-pol.	Standard	7S8SK046540060B01
	8 m	EDP	BSB 35-50 Tuchel 5-pol.	Standard	7S8SK086540060B01
	4 m	EDP	BSB 35-50 Tuchel 5-pol.	High Flex Leder	7S8SH046540060B01
	8 m	EDP	BSB 35-50 Tuchel 5-pol.	High Flex Leder	7S8SH086540060B01
ABITIG® 200	4 m	EDP	BSB 35-50 Tuchel 5-pol.	Standard	7T4SK046540060B01
	8 m	EDP	BSB 35-50 Tuchel 5-pol.	Standard	7T4SK086540060B01
	4 m	EDP	BSB 35-50 Tuchel 5-pol.	High Flex Leder	7T4SH046540060B01
	8 m	EDP	BSB 35-50 Tuchel 5-pol.	High Flex Leder	7T4SH086540060B01
ABITIG® 200F	4 m	EDP	BSB 35-50 Tuchel 5-pol.	Standard	7T4FK046540060B01
	8 m	EDP	BSB 35-50 Tuchel 5-pol.	Standard	7T4FK086540060B01
	4 m	EDP	BSB 35-50 Tuchel 5-pol.	High Flex Leder	7T4FH046540060B01
	8 m	EDP	BSB 35-50 Tuchel 5-pol.	High Flex Leder	7T4FH086540060B01
ABITIG® 150	4 m	EDP	BSB 35-50 Tuchel 5-pol.	Standard	7T6SK046540060B01
	8 m	EDP	BSB 35-50 Tuchel 5-pol.	Standard	7T6SK086540060B01
	4 m	EDP	BSB 35-50 Tuchel 5-pol.	High Flex Leder	7T6SH046540060B01
	8 m	EDP	BSB 35-50 Tuchel 5-pol.	High Flex Leder	7T6SH086540060B01
ABITIG® 150F	4 m	EDP	BSB 35-50 Tuchel 5-pol.	Standard	7T6FK046540060B01
	8 m	EDP	BSB 35-50 Tuchel 5-pol.	Standard	7T6FK086540060B01
	4 m	EDP	BSB 35-50 Tuchel 5-pol.	High Flex Leder	7T6FH046540060B01
	8 m	EDP	BSB 35-50 Tuchel 5-pol.	High Flex Leder	7T6FH086540060B01

ABITIG® GRIP / ABITIG® GRIP Little-Brennerpreisliste

passend für WIG-Stromquellen des Fabrikates „mahe“



Brennertyp	Länge	Schalterfunktion	maschinenseitiger Anschluss	Schlauchpaketausführung	Bestellnummer
ABITIG® 9	4 m	DDP	BSB 35-50 Tuchel 5-pol.	Standard	7S1SK046540060D01
	8 m	DDP	BSB 35-50 Tuchel 5-pol.	Standard	7S1SK086540060D01
	4 m	DDP	BSB 35-50 Tuchel 5-pol.	High Flex Leder	7S1SH046540060D01
	8 m	DDP	BSB 35-50 Tuchel 5-pol.	High Flex Leder	7S1SH086540060D01
ABITIG® 9F	4 m	DDP	BSB 35-50 Tuchel 5-pol.	Standard	7S1FK046540060D01
	8 m	DDP	BSB 35-50 Tuchel 5-pol.	Standard	7S1FK086540060D01
	4 m	DDP	BSB 35-50 Tuchel 5-pol.	High Flex Leder	7S1FH046540060D01
	8 m	DDP	BSB 35-50 Tuchel 5-pol.	High Flex Leder	7S1FH086540060D01
ABITIG® 17	4 m	DDP	BSB 35-50 Tuchel 5-pol.	Standard	7S2SK046540060D01
	8 m	DDP	BSB 35-50 Tuchel 5-pol.	Standard	7S2SK086540060D01
	4 m	DDP	BSB 35-50 Tuchel 5-pol.	High Flex Leder	7S2SH046540060D01
	8 m	DDP	BSB 35-50 Tuchel 5-pol.	High Flex Leder	7S2SH086540060D01
ABITIG® 17F	4 m	DDP	BSB 35-50 Tuchel 5-pol.	Standard	7S2FK046540060D01
	8 m	DDP	BSB 35-50 Tuchel 5-pol.	Standard	7S2FK086540060D01
	4 m	DDP	BSB 35-50 Tuchel 5-pol.	High Flex Leder	7S2FH046540060D01
	8 m	DDP	BSB 35-50 Tuchel 5-pol.	High Flex Leder	7S2FH086540060D01

Technische Änderungen vorbehalten • Verkaufspreise = unverbindliche Preisempfehlung - Angebot freibleibend • © Copyright

ABITIG® GRIP / ABITIG® GRIP Little-Brennerpreisliste

passend für WIG-Stromquellen des Fabrikates „mahe“

Brennertyp	Länge	Schalterfunktion	maschinenseitiger Anschluss	Schlauchpaketausführung	Bestellnummer
ABITIG® 26	4 m	DDP	BSB 35-50 Tuchel 5-pol.	Standard	7S3SK046540060D01
	8 m	DDP	BSB 35-50 Tuchel 5-pol.	Standard	7S3SK086540060D01
	4 m	DDP	BSB 35-50 Tuchel 5-pol.	High Flex Leder	7S3SH046540060D01
	8 m	DDP	BSB 35-50 Tuchel 5-pol.	High Flex Leder	7S3SH086540060D01
ABITIG® 26F	4 m	DDP	BSB 35-50 Tuchel 5-pol.	Standard	7S3FK046540060D01
	8 m	DDP	BSB 35-50 Tuchel 5-pol.	Standard	7S3FK086540060D01
	4 m	DDP	BSB 35-50 Tuchel 5-pol.	High Flex Leder	7S3FH046540060D01
	8 m	DDP	BSB 35-50 Tuchel 5-pol.	High Flex Leder	7S3FH086540060D01
ABITIG® 24G	4 m	DDP	BSB 35-50 Tuchel 5-pol.	Standard	7S8SK046540060D01
	8 m	DDP	BSB 35-50 Tuchel 5-pol.	Standard	7S8SK086540060D01
	4 m	DDP	BSB 35-50 Tuchel 5-pol.	High Flex Leder	7S8SH046540060D01
	8 m	DDP	BSB 35-50 Tuchel 5-pol.	High Flex Leder	7S8SH086540060D01
ABITIG® 200	4 m	DDP	BSB 35-50 Tuchel 5-pol.	Standard	7T4SK046540060D01
	8 m	DDP	BSB 35-50 Tuchel 5-pol.	Standard	7T4SK086540060D01
	4 m	DDP	BSB 35-50 Tuchel 5-pol.	High Flex Leder	7T4SH046540060D01
	8 m	DDP	BSB 35-50 Tuchel 5-pol.	High Flex Leder	7T4SH086540060D01
ABITIG® 200F	4 m	DDP	BSB 35-50 Tuchel 5-pol.	Standard	7T4FK046540060D01
	8 m	DDP	BSB 35-50 Tuchel 5-pol.	Standard	7T4FK086540060D01
	4 m	DDP	BSB 35-50 Tuchel 5-pol.	High Flex Leder	7T4FH046540060D01
	8 m	DDP	BSB 35-50 Tuchel 5-pol.	High Flex Leder	7T4FH086540060D01
ABITIG® 150	4 m	DDP	BSB 35-50 Tuchel 5-pol.	Standard	7T6SK046540060D01
	8 m	DDP	BSB 35-50 Tuchel 5-pol.	Standard	7T6SK086540060D01
	4 m	DDP	BSB 35-50 Tuchel 5-pol.	High Flex Leder	7T6SH046540060D01
	8 m	DDP	BSB 35-50 Tuchel 5-pol.	High Flex Leder	7T6SH086540060D01
ABITIG® 150F	4 m	DDP	BSB 35-50 Tuchel 5-pol.	Standard	7T6FK046540060D01
	8 m	DDP	BSB 35-50 Tuchel 5-pol.	Standard	7T6FK086540060D01
	4 m	DDP	BSB 35-50 Tuchel 5-pol.	High Flex Leder	7T6FH046540060D01
	8 m	DDP	BSB 35-50 Tuchel 5-pol.	High Flex Leder	7T6FH086540060D01

ABITIG® GRIP / ABITIG® GRIP Little-Brennerpreisliste

passend für WIG-Stromquellen des Fabrikates „mahe“



Brennertyp	Länge	Schalterfunktion	maschinenseitiger Anschluss	Schlauchpaketausführung	Bestellnummer
ABITIG® 18	4 m	ED	BSB 35-50 Tuchel 5-pol.	Standard	7S4SK043510060A11
	8 m	ED	BSB 35-50 Tuchel 5-pol.	Standard	7S4SK083510060A11
	4 m	ED	BSB 35-50 Tuchel 5-pol.	High Flex Leder	7S4SH043510060A11
	8 m	ED	BSB 35-50 Tuchel 5-pol.	High Flex Leder	7S4SH083510060A11
ABITIG® 18F	4 m	ED	BSB 35-50 Tuchel 5-pol.	Standard	7S4FK043510060A11
	8 m	ED	BSB 35-50 Tuchel 5-pol.	Standard	7S4FK083510060A11
	4 m	ED	BSB 35-50 Tuchel 5-pol.	High Flex Leder	7S4FH043510060A11
	8 m	ED	BSB 35-50 Tuchel 5-pol.	High Flex Leder	7S4FH083510060A11
ABITIG® 20	4 m	ED	BSB 35-50 Tuchel 5-pol.	Standard	7S5SK043510060A11
	8 m	ED	BSB 35-50 Tuchel 5-pol.	Standard	7S5SK083510060A11
	4 m	ED	BSB 35-50 Tuchel 5-pol.	High Flex Leder	7S5SH043510060A11
	8 m	ED	BSB 35-50 Tuchel 5-pol.	High Flex Leder	7S5SH083510060A11
ABITIG® 20 Little	4 m	ED	BSB 35-50 Tuchel 5-pol.	High Flex Leder	7L5SH043510060A11
	8 m	ED	BSB 35-50 Tuchel 5-pol.	High Flex Leder	7L5SH083510060A11
ABITIG® 20F	4 m	ED	BSB 35-50 Tuchel 5-pol.	Standard	7S5FK043510060A11
	8 m	ED	BSB 35-50 Tuchel 5-pol.	Standard	7S5FK083510060A11
	4 m	ED	BSB 35-50 Tuchel 5-pol.	High Flex Leder	7S5FH043510060A11
	8 m	ED	BSB 35-50 Tuchel 5-pol.	High Flex Leder	7S5FH083510060A11
ABITIG® 20F Little	4 m	ED	BSB 35-50 Tuchel 5-pol.	High Flex Leder	7L5FH043510060A11
	8 m	ED	BSB 35-50 Tuchel 5-pol.	High Flex Leder	7L5FH083510060A11

Technische Änderungen vorbehalten • Verkaufspreise = unverbindliche Preisempfehlung - Angebot freibleibend • © Copyright

ABITIG® GRIP / ABITIG® GRIP Little-Brennerpreisliste

passend für WIG-Stromquellen des Fabrikates „mahe“

Brennertyp	Länge	Schalterfunktion	maschinenseitiger Anschluss	Schlauchpaketausführung	Bestellnummer
ABITIG® 12-1	4 m	ED	BSB 35-50 Tuchel 5-pol.	Standard	7S6SK043510060A11
	8 m	ED	BSB 35-50 Tuchel 5-pol.	Standard	7S6SK083510060A11
	4 m	ED	BSB 35-50 Tuchel 5-pol.	High Flex Leder	7S6SH043510060A11
	8 m	ED	BSB 35-50 Tuchel 5-pol.	High Flex Leder	7S6SH083510060A11
ABITIG® 18SC	4 m	ED	BSB 35-50 Tuchel 5-pol.	Standard	7S7SK043510060A11
	8 m	ED	BSB 35-50 Tuchel 5-pol.	Standard	7S7SK083510060A11
	4 m	ED	BSB 35-50 Tuchel 5-pol.	High Flex Leder	7S7SH043510060A11
	8 m	ED	BSB 35-50 Tuchel 5-pol.	High Flex Leder	7S7SH083510060A11
ABITIG® 24W	4 m	ED	BSB 35-50 Tuchel 5-pol.	Standard	7S9SK043510060A11
	8 m	ED	BSB 35-50 Tuchel 5-pol.	Standard	7S9SK083510060A11
	4 m	ED	BSB 35-50 Tuchel 5-pol.	High Flex Leder	7S9SH043510060A11
	8 m	ED	BSB 35-50 Tuchel 5-pol.	High Flex Leder	7S9SH083510060A11
ABITIG® 24W Little	4 m	ED	BSB 35-50 Tuchel 5-pol.	High Flex Leder	7L9SH043510060A11
	8 m	ED	BSB 35-50 Tuchel 5-pol.	High Flex Leder	7L9SH083510060A11
ABITIG® 450W	4 m	ED	BSB 35-50 Tuchel 5-pol.	Standard	7T5SK043510160A11
	8 m	ED	BSB 35-50 Tuchel 5-pol.	Standard	7T5SK083510160A11
	4 m	ED	BSB 35-50 Tuchel 5-pol.	High Flex Leder	7T5SH043510160A11
	8 m	ED	BSB 35-50 Tuchel 5-pol.	High Flex Leder	7T5SH083510160A11
ABITIG® 260W	4 m	ED	BSB 35-50 Tuchel 5-pol.	Standard	7T7SK043510160A11
	8 m	ED	BSB 35-50 Tuchel 5-pol.	Standard	7T7SK083510160A11
	4 m	ED	BSB 35-50 Tuchel 5-pol.	High Flex Leder	7T7SH043510160A11
	8 m	ED	BSB 35-50 Tuchel 5-pol.	High Flex Leder	7T7SH083510160A11
ABITIG® 260W Little	4 m	ED	BSB 35-50 Tuchel 5-pol.	High Flex Leder	7L7SH043510160A11
	8 m	ED	BSB 35-50 Tuchel 5-pol.	High Flex Leder	7L7SH083510160A11
ABITIG® 450W SC	4 m	ED	BSB 35-50 Tuchel 5-pol.	Standard	
	8 m	ED	BSB 35-50 Tuchel 5-pol.	Standard	
	4 m	ED	BSB 35-50 Tuchel 5-pol.	High Flex Leder	7T8SH043510160A11
	8 m	ED	BSB 35-50 Tuchel 5-pol.	High Flex Leder	7T8SH083510160A11

ABITIG® GRIP / ABITIG® GRIP Little-Brennerpreisliste

passend für WIG-Stromquellen des Fabrikates „mahe“



Brennertyp	Länge	Schalterfunktion	maschinenseitiger Anschluss	Schlauchpaketausführung	Bestellnummer
ABITIG® 18	4 m	DD	BSB 35-50 Tuchel 5-pol.	Standard	7S4SK043520060C11
	8 m	DD	BSB 35-50 Tuchel 5-pol.	Standard	7S4SK083520060C11
	4 m	DD	BSB 35-50 Tuchel 5-pol.	High Flex Leder	7S4SH043520060C11
	8 m	DD	BSB 35-50 Tuchel 5-pol.	High Flex Leder	7S4SH083520060C11
ABITIG® 18F	4 m	DD	BSB 35-50 Tuchel 5-pol.	Standard	7S4FK043520060C11
	8 m	DD	BSB 35-50 Tuchel 5-pol.	Standard	7S4FK083520060C11
	4 m	DD	BSB 35-50 Tuchel 5-pol.	High Flex Leder	7S4FH043520060C11
	8 m	DD	BSB 35-50 Tuchel 5-pol.	High Flex Leder	7S4FH083520060C11
ABITIG® 20	4 m	DD	BSB 35-50 Tuchel 5-pol.	Standard	7S5SK043520060C11
	8 m	DD	BSB 35-50 Tuchel 5-pol.	Standard	7S5SK083520060C11
	4 m	DD	BSB 35-50 Tuchel 5-pol.	High Flex Leder	7S5SH043520060C11
	8 m	DD	BSB 35-50 Tuchel 5-pol.	High Flex Leder	7S5SH083520060C11
ABITIG® 20 Little	4 m	DD	BSB 35-50 Tuchel 5-pol.	High Flex Leder	7L5SH043520060C11
	8 m	DD	BSB 35-50 Tuchel 5-pol.	High Flex Leder	7L5SH083520060C11
ABITIG® 20F	4 m	DD	BSB 35-50 Tuchel 5-pol.	Standard	7S5FK043520060C11
	8 m	DD	BSB 35-50 Tuchel 5-pol.	Standard	7S5FK083520060C11
	4 m	DD	BSB 35-50 Tuchel 5-pol.	High Flex Leder	7S5FH043520060C11
	8 m	DD	BSB 35-50 Tuchel 5-pol.	High Flex Leder	7S5FH083520060C11
ABITIG® 20F Little	4 m	DD	BSB 35-50 Tuchel 5-pol.	High Flex Leder	7L5FH043520060C11
	8 m	DD	BSB 35-50 Tuchel 5-pol.	High Flex Leder	7L5FH083520060C11

Technische Änderungen vorbehalten • Verkaufspreise = unverbindliche Preisempfehlung - Angebot freibleibend • © Copyright

ABITIG® GRIP / ABITIG® GRIP Little-Brennerpreisliste

passend für WIG-Stromquellen des Fabrikates „mahe“

Brennertyp	Länge	Schalterfunktion	maschinenseitiger Anschluss	Schlauchpaketausführung	Bestellnummer
ABITIG® 12-1	4 m	DD	BSB 35-50 Tuchel 5-pol.	Standard	7S6SK043520060C11
	8 m	DD	BSB 35-50 Tuchel 5-pol.	Standard	7S6SK083520060C11
	4 m	DD	BSB 35-50 Tuchel 5-pol.	High Flex Leder	7S6SH043520060C11
	8 m	DD	BSB 35-50 Tuchel 5-pol.	High Flex Leder	7S6SH083520060C11
<hr/>					
ABITIG® 18SC	4 m	DD	BSB 35-50 Tuchel 5-pol.	Standard	7S7SK043520060C11
	8 m	DD	BSB 35-50 Tuchel 5-pol.	Standard	7S7SK083520060C11
	4 m	DD	BSB 35-50 Tuchel 5-pol.	High Flex Leder	7S7SH043520060C11
	8 m	DD	BSB 35-50 Tuchel 5-pol.	High Flex Leder	7S7SH083520060C11
<hr/>					
ABITIG® 24W	4 m	DD	BSB 35-50 Tuchel 5-pol.	Standard	7S9SK043520060C11
	8 m	DD	BSB 35-50 Tuchel 5-pol.	Standard	7S9SK083520060C11
	4 m	DD	BSB 35-50 Tuchel 5-pol.	High Flex Leder	7S9SH043520060C11
	8 m	DD	BSB 35-50 Tuchel 5-pol.	High Flex Leder	7S9SH083520060C11
ABITIG® 24W Little	4 m	DD	BSB 35-50 Tuchel 5-pol.	High Flex Leder	7L9SH043520060C11
	8 m	DD	BSB 35-50 Tuchel 5-pol.	High Flex Leder	7L9SH083520060C11
<hr/>					
ABITIG® 450W	4 m	DD	BSB 35-50 Tuchel 5-pol.	Standard	7T5SK043520160C11
	8 m	DD	BSB 35-50 Tuchel 5-pol.	Standard	7T5SK083520160C11
	4 m	DD	BSB 35-50 Tuchel 5-pol.	High Flex Leder	7T5SH043520160C11
	8 m	DD	BSB 35-50 Tuchel 5-pol.	High Flex Leder	7T5SH083520160C11
<hr/>					
ABITIG® 260W	4 m	DD	BSB 35-50 Tuchel 5-pol.	Standard	7T7SK043520160C11
	8 m	DD	BSB 35-50 Tuchel 5-pol.	Standard	7T7SK083520160C11
	4 m	DD	BSB 35-50 Tuchel 5-pol.	High Flex Leder	7T7SH043520160C11
	8 m	DD	BSB 35-50 Tuchel 5-pol.	High Flex Leder	7T7SH083520160C11
ABITIG® 260W Little	4 m	DD	BSB 35-50 Tuchel 5-pol.	High Flex Leder	7L7SH043520160C11
	8 m	DD	BSB 35-50 Tuchel 5-pol.	High Flex Leder	7L7SH083520160C11
<hr/>					
ABITIG® 450W SC	4 m	DD	BSB 35-50 Tuchel 5-pol.	Standard	
	8 m	DD	BSB 35-50 Tuchel 5-pol.	Standard	
	4 m	DD	BSB 35-50 Tuchel 5-pol.	High Flex Leder	7T8SH043520160C11
	8 m	DD	BSB 35-50 Tuchel 5-pol.	High Flex Leder	7T8SH083520160C11

ABITIG® GRIP / ABITIG® GRIP Little-Brennerpreisliste

passend für WIG-Stromquellen des Fabrikates „mahe“



Brennertyp	Länge	Schalterfunktion	maschinenseitiger Anschluss	Schlauchpaketausführung	Bestellnummer
ABITIG® 18	4 m	EDP	BSB 35-50 Tuchel 5-pol.	Standard	7S4SK046540060B11
	8 m	EDP	BSB 35-50 Tuchel 5-pol.	Standard	7S4SK086540060B11
	4 m	EDP	BSB 35-50 Tuchel 5-pol.	High Flex Leder	7S4SH046540060B11
	8 m	EDP	BSB 35-50 Tuchel 5-pol.	High Flex Leder	7S4SH086540060B11
ABITIG® 18F	4 m	EDP	BSB 35-50 Tuchel 5-pol.	Standard	7S4FK046540060B11
	8 m	EDP	BSB 35-50 Tuchel 5-pol.	Standard	7S4FK086540060B11
	4 m	EDP	BSB 35-50 Tuchel 5-pol.	High Flex Leder	7S4FH046540060B11
	8 m	EDP	BSB 35-50 Tuchel 5-pol.	High Flex Leder	7S4FH086540060B11
ABITIG® 20	4 m	EDP	BSB 35-50 Tuchel 5-pol.	Standard	7S5SK046540060B11
	8 m	EDP	BSB 35-50 Tuchel 5-pol.	Standard	7S5SK086540060B11
	4 m	EDP	BSB 35-50 Tuchel 5-pol.	High Flex Leder	7S5SH046540060B11
	8 m	EDP	BSB 35-50 Tuchel 5-pol.	High Flex Leder	7S5SH086540060B11
ABITIG® 20F	4 m	EDP	BSB 35-50 Tuchel 5-pol.	Standard	7S5FK046540060B11
	8 m	EDP	BSB 35-50 Tuchel 5-pol.	Standard	7S5FK086540060B11
	4 m	EDP	BSB 35-50 Tuchel 5-pol.	High Flex Leder	7S5FH046540060B11
	8 m	EDP	BSB 35-50 Tuchel 5-pol.	High Flex Leder	7S5FH086540060B11

Technische Änderungen vorbehalten • Verkaufspreise = unverbindliche Preisempfehlung - Angebot freibleibend • © Copyright

ABITIG® GRIP / ABITIG® GRIP Little-Brennerpreisliste

passend für WIG-Stromquellen des Fabrikates „mahe“

Brennertyp	Länge	Schalterfunktion	maschinenseitiger Anschluss	Schlauchpaketausführung	Bestellnummer
ABITIG® 12-1	4 m	EDP	BSB 35-50 Tuchel 5-pol.	Standard	7S6SK046540060B11
	8 m	EDP	BSB 35-50 Tuchel 5-pol.	Standard	7S6SK086540060B11
	4 m	EDP	BSB 35-50 Tuchel 5-pol.	High Flex Leder	7S6SH046540060B11
	8 m	EDP	BSB 35-50 Tuchel 5-pol.	High Flex Leder	7S6SH086540060B11
ABITIG® 18SC	4 m	EDP	BSB 35-50 Tuchel 5-pol.	Standard	7S7SK046540060B11
	8 m	EDP	BSB 35-50 Tuchel 5-pol.	Standard	7S7SK086540060B11
	4 m	EDP	BSB 35-50 Tuchel 5-pol.	High Flex Leder	7S7SH046540060B11
	8 m	EDP	BSB 35-50 Tuchel 5-pol.	High Flex Leder	7S7SH086540060B11
ABITIG® 24W	4 m	EDP	BSB 35-50 Tuchel 5-pol.	Standard	7S9SK046540060B11
	8 m	EDP	BSB 35-50 Tuchel 5-pol.	Standard	7S9SK086540060B11
	4 m	EDP	BSB 35-50 Tuchel 5-pol.	High Flex Leder	7S9SH046540060B11
	8 m	EDP	BSB 35-50 Tuchel 5-pol.	High Flex Leder	7S9SH086540060B11
ABITIG® 450W	4 m	EDP	BSB 35-50 Tuchel 5-pol.	Standard	7T5SK046540160B11
	8 m	EDP	BSB 35-50 Tuchel 5-pol.	Standard	7T5SK086540160B11
	4 m	EDP	BSB 35-50 Tuchel 5-pol.	High Flex Leder	7T5SH046540160B11
	8 m	EDP	BSB 35-50 Tuchel 5-pol.	High Flex Leder	7T5SH086540160B11
ABITIG® 260W	4 m	EDP	BSB 35-50 Tuchel 5-pol.	Standard	7T7SK046540160B11
	8 m	EDP	BSB 35-50 Tuchel 5-pol.	Standard	7T7SK086540160B11
	4 m	EDP	BSB 35-50 Tuchel 5-pol.	High Flex Leder	7T7SH046540160B11
	8 m	EDP	BSB 35-50 Tuchel 5-pol.	High Flex Leder	7T7SH086540160B11
ABITIG® 450W SC	4 m	EDP	BSB 35-50 Tuchel 5-pol.	Standard	
	8 m	EDP	BSB 35-50 Tuchel 5-pol.	Standard	
	4 m	EDP	BSB 35-50 Tuchel 5-pol.	High Flex Leder	7T8SH046540160B11
	8 m	EDP	BSB 35-50 Tuchel 5-pol.	High Flex Leder	7T8SH086540160B11

ABITIG® GRIP / ABITIG® GRIP Little-Brennerpreisliste

passend für WIG-Stromquellen des Fabrikates „mahe“



Brennertyp	Länge	Schalterfunktion	maschinenseitiger Anschluss	Schlauchpaketausführung	Bestellnummer
ABITIG® 18	4 m	DDP	BSB 35-50 Tuchel 5-pol.	Standard	7S4SK046540060D11
	8 m	DDP	BSB 35-50 Tuchel 5-pol.	Standard	7S4SK086540060D11
	4 m	DDP	BSB 35-50 Tuchel 5-pol.	High Flex Leder	7S4SH046540060D11
	8 m	DDP	BSB 35-50 Tuchel 5-pol.	High Flex Leder	7S4SH086540060D11
ABITIG® 18F	4 m	DDP	BSB 35-50 Tuchel 5-pol.	Standard	7S4FK046540060D11
	8 m	DDP	BSB 35-50 Tuchel 5-pol.	Standard	7S4FK086540060D11
	4 m	DDP	BSB 35-50 Tuchel 5-pol.	High Flex Leder	7S4FH046540060D11
	8 m	DDP	BSB 35-50 Tuchel 5-pol.	High Flex Leder	7S4FH086540060D11
ABITIG® 20	4 m	DDP	BSB 35-50 Tuchel 5-pol.	Standard	7S5SK046540060D11
	8 m	DDP	BSB 35-50 Tuchel 5-pol.	Standard	7S5SK086540060D11
	4 m	DDP	BSB 35-50 Tuchel 5-pol.	High Flex Leder	7S5SH046540060D11
	8 m	DDP	BSB 35-50 Tuchel 5-pol.	High Flex Leder	7S5SH086540060D11
ABITIG® 20F	4 m	DDP	BSB 35-50 Tuchel 5-pol.	Standard	7S5FK046540060D11
	8 m	DDP	BSB 35-50 Tuchel 5-pol.	Standard	7S5FK086540060D11
	4 m	DDP	BSB 35-50 Tuchel 5-pol.	High Flex Leder	7S5FH046540060D11
	8 m	DDP	BSB 35-50 Tuchel 5-pol.	High Flex Leder	7S5FH086540060D11

Technische Änderungen vorbehalten • Verkaufspreise = unverbindliche Preisempfehlung - Angebot freibleibend • © Copyright

ABITIG® GRIP / ABITIG® GRIP Little-Brennerpreisliste

passend für WIG-Stromquellen des Fabrikates „mahe“

Brennertyp	Länge	Schalterfunktion	maschinenseitiger Anschluss	Schlauchpaketausführung	Bestellnummer
ABITIG® 12-1	4 m	DDP	BSB 35-50 Tuchel 5-pol.	Standard	7S6SK046540060D11
	8 m	DDP	BSB 35-50 Tuchel 5-pol.	Standard	7S6SK086540060D11
	4 m	DDP	BSB 35-50 Tuchel 5-pol.	High Flex Leder	7S6SH046540060D11
	8 m	DDP	BSB 35-50 Tuchel 5-pol.	High Flex Leder	7S6SH086540060D11
ABITIG® 18SC	4 m	DDP	BSB 35-50 Tuchel 5-pol.	Standard	7S7SK046540060D11
	8 m	DDP	BSB 35-50 Tuchel 5-pol.	Standard	7S7SK086540060D11
	4 m	DDP	BSB 35-50 Tuchel 5-pol.	High Flex Leder	7S7SH046540060D11
	8 m	DDP	BSB 35-50 Tuchel 5-pol.	High Flex Leder	7S7SH086540060D11
ABITIG® 24W	4 m	DDP	BSB 35-50 Tuchel 5-pol.	Standard	7S9SK046540060D11
	8 m	DDP	BSB 35-50 Tuchel 5-pol.	Standard	7S9SK086540060D11
	4 m	DDP	BSB 35-50 Tuchel 5-pol.	High Flex Leder	7S9SH046540060D11
	8 m	DDP	BSB 35-50 Tuchel 5-pol.	High Flex Leder	7S9SH086540060D11
ABITIG® 450W	4 m	DDP	BSB 35-50 Tuchel 5-pol.	Standard	7T5SK046540160D11
	8 m	DDP	BSB 35-50 Tuchel 5-pol.	Standard	7T5SK086540160D11
	4 m	DDP	BSB 35-50 Tuchel 5-pol.	High Flex Leder	7T5SH046540160D11
	8 m	DDP	BSB 35-50 Tuchel 5-pol.	High Flex Leder	7T5SH086540160D11
ABITIG® 260W	4 m	DDP	BSB 35-50 Tuchel 5-pol.	Standard	7T7SK046540160D11
	8 m	DDP	BSB 35-50 Tuchel 5-pol.	Standard	7T7SK086540160D11
	4 m	DDP	BSB 35-50 Tuchel 5-pol.	High Flex Leder	7T7SH046540160D11
	8 m	DDP	BSB 35-50 Tuchel 5-pol.	High Flex Leder	7T7SH086540160D11
ABITIG® 450W SC	4 m	DDP	BSB 35-50 Tuchel 5-pol.	Standard	
	8 m	DDP	BSB 35-50 Tuchel 5-pol.	Standard	
	4 m	DDP	BSB 35-50 Tuchel 5-pol.	High Flex Leder	7T8SH046540160D11
	8 m	DDP	BSB 35-50 Tuchel 5-pol.	High Flex Leder	7T8SH086540160D11

ABITIG® GRIP / ABITIG® GRIP Little-Brennerpreisliste

passend für WIG-Stromquellen des Fabrikates „merkle“



Brennertyp	Länge	Schalterfunktion	maschinenseitiger Anschluss	Schlauchpaketausführung	Bestellnummer
ABITIG® 9	4 m	ED/DD	ZA - GZ Tuchel 3-pol.	Standard	7S1SK047520313A00
	8 m	ED/DD	ZA - GZ Tuchel 3-pol.	Standard	7S1SK087520313A00
	4 m	ED/DD	ZA - GZ Tuchel 3-pol.	High Flex Leder	7S1SH047520313A00
	8 m	ED/DD	ZA - GZ Tuchel 3-pol.	High Flex Leder	7S1SH087520313A00
ABITIG® 9 Little	4 m	ED/DD	ZA - GZ Tuchel 3-pol.	High Flex Leder	7L1SH047520313A00
	8 m	ED/DD	ZA - GZ Tuchel 3-pol.	High Flex Leder	7L1SH087520313A00
ABITIG® 9F	4 m	ED/DD	ZA - GZ Tuchel 3-pol.	Standard	7S1FK047520313A00
	8 m	ED/DD	ZA - GZ Tuchel 3-pol.	Standard	7S1FK087520313A00
	4 m	ED/DD	ZA - GZ Tuchel 3-pol.	High Flex Leder	7S1FH047520313A00
	8 m	ED/DD	ZA - GZ Tuchel 3-pol.	High Flex Leder	7S1FH087520313A00
ABITIG® 9F Little	4 m	ED/DD	ZA - GZ Tuchel 3-pol.	High Flex Leder	7L1FH047520313A00
	8 m	ED/DD	ZA - GZ Tuchel 3-pol.	High Flex Leder	7L1FH087520313A00
ABITIG® 17	4 m	ED/DD	ZA - GZ Tuchel 3-pol.	Standard	7S2SK047520313A00
	8 m	ED/DD	ZA - GZ Tuchel 3-pol.	Standard	7S2SK087520313A00
	4 m	ED/DD	ZA - GZ Tuchel 3-pol.	High Flex Leder	7S2SH047520313A00
	8 m	ED/DD	ZA - GZ Tuchel 3-pol.	High Flex Leder	7S2SH087520313A00
ABITIG® 17 Little	4 m	ED/DD	ZA - GZ Tuchel 3-pol.	High Flex Leder	7L2SH047520313A00
	8 m	ED/DD	ZA - GZ Tuchel 3-pol.	High Flex Leder	7L2SH087520313A00
ABITIG® 17F	4 m	ED/DD	ZA - GZ Tuchel 3-pol.	Standard	7S2FK047520313A00
	8 m	ED/DD	ZA - GZ Tuchel 3-pol.	Standard	7S2FK087520313A00
	4 m	ED/DD	ZA - GZ Tuchel 3-pol.	High Flex Leder	7S2FH047520313A00
	8 m	ED/DD	ZA - GZ Tuchel 3-pol.	High Flex Leder	7S2FH087520313A00
ABITIG® 17F Little	4 m	ED/DD	ZA - GZ Tuchel 3-pol.	High Flex Leder	7L2FH047520313A00
	8 m	ED/DD	ZA - GZ Tuchel 3-pol.	High Flex Leder	7L2FH087520313A00

Technische Änderungen vorbehalten • Verkaufspreise = unverbindliche Preisempfehlung - Angebot freibleibend • © Copyright

ABITIG® GRIP / ABITIG® GRIP Little-Brennerpreisliste

passend für WIG-Stromquellen des Fabrikates „merkle“

Brennertyp	Länge	Schalterfunktion	maschinenseitiger Anschluss	Schlauchpaketausführung	Bestellnummer
ABITIG® 26	4 m	ED/DD	ZA - GZ Tuchel 3-pol.	Standard	7S3SK047520313A00
	8 m	ED/DD	ZA - GZ Tuchel 3-pol.	Standard	7S3SK087520313A00
	4 m	ED/DD	ZA - GZ Tuchel 3-pol.	High Flex Leder	7S3SH047520313A00
	8 m	ED/DD	ZA - GZ Tuchel 3-pol.	High Flex Leder	7S3SH087520313A00
ABITIG® 26F	4 m	ED/DD	ZA - GZ Tuchel 3-pol.	Standard	7S3FK047520313A00
	8 m	ED/DD	ZA - GZ Tuchel 3-pol.	Standard	7S3FK087520313A00
	4 m	ED/DD	ZA - GZ Tuchel 3-pol.	High Flex Leder	7S3FH047520313A00
	8 m	ED/DD	ZA - GZ Tuchel 3-pol.	High Flex Leder	7S3FH087520313A00
ABITIG® 24G	4 m	ED/DD	ZA - GZ Tuchel 3-pol.	Standard	7S8SK047520313A00
	8 m	ED/DD	ZA - GZ Tuchel 3-pol.	Standard	7S8SK087520313A00
	4 m	ED/DD	ZA - GZ Tuchel 3-pol.	High Flex Leder	7S8SH047520313A00
	8 m	ED/DD	ZA - GZ Tuchel 3-pol.	High Flex Leder	7S8SH087520313A00
ABITIG® 24G Little	4 m	ED/DD	ZA - GZ Tuchel 3-pol.	High Flex Leder	7L8SH047520313A00
	8 m	ED/DD	ZA - GZ Tuchel 3-pol.	High Flex Leder	7L8SH087520313A00
ABITIG® 200	4 m	ED/DD	ZA - GZ Tuchel 3-pol.	Standard	7T4SK047520313A00
	8 m	ED/DD	ZA - GZ Tuchel 3-pol.	Standard	7T4SK087520313A00
	4 m	ED/DD	ZA - GZ Tuchel 3-pol.	High Flex Leder	7T4SH047520313A00
	8 m	ED/DD	ZA - GZ Tuchel 3-pol.	High Flex Leder	7T4SH087520313A00
ABITIG® 200F	4 m	ED/DD	ZA - GZ Tuchel 3-pol.	Standard	7T4FK047520313A00
	8 m	ED/DD	ZA - GZ Tuchel 3-pol.	Standard	7T4FK087520313A00
	4 m	ED/DD	ZA - GZ Tuchel 3-pol.	High Flex Leder	7T4FH047520313A00
	8 m	ED/DD	ZA - GZ Tuchel 3-pol.	High Flex Leder	7T4FH087520313A00
ABITIG® 150	4 m	ED/DD	ZA - GZ Tuchel 3-pol.	Standard	7T6SK047520313A00
	8 m	ED/DD	ZA - GZ Tuchel 3-pol.	Standard	7T6SK087520313A00
	4 m	ED/DD	ZA - GZ Tuchel 3-pol.	High Flex Leder	7T6SH047520313A00
	8 m	ED/DD	ZA - GZ Tuchel 3-pol.	High Flex Leder	7T6SH087520313A00
ABITIG® 150 Little	4 m	ED/DD	ZA - GZ Tuchel 3-pol.	High Flex Leder	7L6SH047520313A00
	8 m	ED/DD	ZA - GZ Tuchel 3-pol.	High Flex Leder	7L6SH087520313A00
ABITIG® 150F	4 m	ED/DD	ZA - GZ Tuchel 3-pol.	Standard	7T6FK047520313A00
	8 m	ED/DD	ZA - GZ Tuchel 3-pol.	Standard	7T6FK087520313A00
	4 m	ED/DD	ZA - GZ Tuchel 3-pol.	High Flex Leder	7T6FH047520313A00
	8 m	ED/DD	ZA - GZ Tuchel 3-pol.	High Flex Leder	7T6FH087520313A00
ABITIG® 150F Little	4 m	ED/DD	ZA - GZ Tuchel 3-pol.	High Flex Leder	7L6FH047520313A00
	8 m	ED/DD	ZA - GZ Tuchel 3-pol.	High Flex Leder	7L6FH087520313A00

ABITIG® GRIP / ABITIG® GRIP Little-Brennerpreisliste

passend für WIG-Stromquellen des Fabrikates „merkle“



Brennertyp	Länge	Schalterfunktion	maschinenseitiger Anschluss	Schlauchpaketausführung	Bestellnummer
ABITIG® 9	4 m	DD	ZA - GZ Tuchel 5-pol.	Standard	7S1SK043520301A00
	8 m	DD	ZA - GZ Tuchel 5-pol.	Standard	7S1SK083520301A00
	4 m	DD	ZA - GZ Tuchel 5-pol.	High Flex Leder	7S1SH043520301A00
	8 m	DD	ZA - GZ Tuchel 5-pol.	High Flex Leder	7S1SH083520301A00
ABITIG® 9 Little	4 m	DD	ZA - GZ Tuchel 5-pol.	High Flex Leder	7L1SH043520301A00
	8 m	DD	ZA - GZ Tuchel 5-pol.	High Flex Leder	7L1SH083520301A00
ABITIG® 9F	4 m	DD	ZA - GZ Tuchel 5-pol.	Standard	7S1FK043520301A00
	8 m	DD	ZA - GZ Tuchel 5-pol.	Standard	7S1FK083520301A00
	4 m	DD	ZA - GZ Tuchel 5-pol.	High Flex Leder	7S1FH043520301A00
	8 m	DD	ZA - GZ Tuchel 5-pol.	High Flex Leder	7S1FH083520301A00
ABITIG® 9F Little	4 m	DD	ZA - GZ Tuchel 5-pol.	High Flex Leder	7L1FH043520301A00
	8 m	DD	ZA - GZ Tuchel 5-pol.	High Flex Leder	7L1FH083520301A00
ABITIG® 17	4 m	DD	ZA - GZ Tuchel 5-pol.	Standard	7S2SK043520301A00
	8 m	DD	ZA - GZ Tuchel 5-pol.	Standard	7S2SK083520301A00
	4 m	DD	ZA - GZ Tuchel 5-pol.	High Flex Leder	7S2SH043520301A00
	8 m	DD	ZA - GZ Tuchel 5-pol.	High Flex Leder	7S2SH083520301A00
ABITIG® 17 Little	4 m	DD	ZA - GZ Tuchel 5-pol.	High Flex Leder	7L2SH043520301A00
	8 m	DD	ZA - GZ Tuchel 5-pol.	High Flex Leder	7L2SH083520301A00
ABITIG® 17F	4 m	DD	ZA - GZ Tuchel 5-pol.	Standard	7S2FK043520301A00
	8 m	DD	ZA - GZ Tuchel 5-pol.	Standard	7S2FK083520301A00
	4 m	DD	ZA - GZ Tuchel 5-pol.	High Flex Leder	7S2FH043520301A00
	8 m	DD	ZA - GZ Tuchel 5-pol.	High Flex Leder	7S2FH083520301A00
ABITIG® 17F Little	4 m	DD	ZA - GZ Tuchel 5-pol.	High Flex Leder	7L2FH043520301A00
	8 m	DD	ZA - GZ Tuchel 5-pol.	High Flex Leder	7L2FH083520301A00

Technische Änderungen vorbehalten • Verkaufspreise = unverbindliche Preisempfehlung - Angebot freibleibend • © Copyright

ABITIG® GRIP / ABITIG® GRIP Little-Brennerpreisliste

passend für WIG-Stromquellen des Fabrikates „merkle“

Brennertyp	Länge	Schalterfunktion	maschinenseitiger Anschluss	Schlauchpaketausführung	Bestellnummer
ABITIG® 26	4 m	DD	ZA - GZ Tuchel 5-pol.	Standard	7S3SK043520301A00
	8 m	DD	ZA - GZ Tuchel 5-pol.	Standard	7S3SK083520301A00
	4 m	DD	ZA - GZ Tuchel 5-pol.	High Flex Leder	7S3SH043520301A00
	8 m	DD	ZA - GZ Tuchel 5-pol.	High Flex Leder	7S3SH083520301A00
ABITIG® 26F	4 m	DD	ZA - GZ Tuchel 5-pol.	Standard	7S3FK043520301A00
	8 m	DD	ZA - GZ Tuchel 5-pol.	Standard	7S3FK083520301A00
	4 m	DD	ZA - GZ Tuchel 5-pol.	High Flex Leder	7S3FH043520301A00
	8 m	DD	ZA - GZ Tuchel 5-pol.	High Flex Leder	7S3FH083520301A00
ABITIG® 24G	4 m	DD	ZA - GZ Tuchel 5-pol.	Standard	7S8SK043520301A00
	8 m	DD	ZA - GZ Tuchel 5-pol.	Standard	7S8SK083520301A00
	4 m	DD	ZA - GZ Tuchel 5-pol.	High Flex Leder	7S8SH043520301A00
	8 m	DD	ZA - GZ Tuchel 5-pol.	High Flex Leder	7S8SH083520301A00
ABITIG® 24G Little	4 m	DD	ZA - GZ Tuchel 5-pol.	High Flex Leder	7L8SH043520301A00
	8 m	DD	ZA - GZ Tuchel 5-pol.	High Flex Leder	7L8SH083520301A00
ABITIG® 200	4 m	DD	ZA - GZ Tuchel 5-pol.	Standard	7T4SK043520301A00
	8 m	DD	ZA - GZ Tuchel 5-pol.	Standard	7T4SK083520301A00
	4 m	DD	ZA - GZ Tuchel 5-pol.	High Flex Leder	7T4SH043520301A00
	8 m	DD	ZA - GZ Tuchel 5-pol.	High Flex Leder	7T4SH083520301A00
ABITIG® 200F	4 m	DD	ZA - GZ Tuchel 5-pol.	Standard	7T4FK043520301A00
	8 m	DD	ZA - GZ Tuchel 5-pol.	Standard	7T4FK083520301A00
	4 m	DD	ZA - GZ Tuchel 5-pol.	High Flex Leder	7T4FH043520301A00
	8 m	DD	ZA - GZ Tuchel 5-pol.	High Flex Leder	7T4FH083520301A00
ABITIG® 150	4 m	DD	ZA - GZ Tuchel 5-pol.	Standard	7T6SK043520301A00
	8 m	DD	ZA - GZ Tuchel 5-pol.	Standard	7T6SK083520301A00
	4 m	DD	ZA - GZ Tuchel 5-pol.	High Flex Leder	7T6SH043520301A00
	8 m	DD	ZA - GZ Tuchel 5-pol.	High Flex Leder	7T6SH083520301A00
ABITIG® 150 Little	4 m	DD	ZA - GZ Tuchel 5-pol.	High Flex Leder	7L6SH043520301A00
	8 m	DD	ZA - GZ Tuchel 5-pol.	High Flex Leder	7L6SH083520301A00
ABITIG® 150F	4 m	DD	ZA - GZ Tuchel 5-pol.	Standard	7T6FK043520301A00
	8 m	DD	ZA - GZ Tuchel 5-pol.	Standard	7T6FK083520301A00
	4 m	DD	ZA - GZ Tuchel 5-pol.	High Flex Leder	7T6FH043520301A00
	8 m	DD	ZA - GZ Tuchel 5-pol.	High Flex Leder	7T6FH083520301A00
ABITIG® 150F Little	4 m	DD	ZA - GZ Tuchel 5-pol.	High Flex Leder	7L6FH043520301A00
	8 m	DD	ZA - GZ Tuchel 5-pol.	High Flex Leder	7L6FH083520301A00

ABITIG® GRIP / ABITIG® GRIP Little-Brennerpreisliste

passend für WIG-Stromquellen des Fabrikates „merkle“



Brennertyp	Länge	Schalterfunktion	maschinenseitiger Anschluss	Schlauchpaketausführung	Bestellnummer
ABITIG® 9	4 m	EDP	ZA - GZ Tuchel 5-pol.	Standard	7S1SK046540330A00
	8 m	EDP	ZA - GZ Tuchel 5-pol.	Standard	7S1SK086540330A00
	4 m	EDP	ZA - GZ Tuchel 5-pol.	High Flex Leder	7S1SH046540330A00
	8 m	EDP	ZA - GZ Tuchel 5-pol.	High Flex Leder	7S1SH086540330A00
ABITIG® 9F	4 m	EDP	ZA - GZ Tuchel 5-pol.	Standard	7S1FK046540330A00
	8 m	EDP	ZA - GZ Tuchel 5-pol.	Standard	7S1FK086540330A00
	4 m	EDP	ZA - GZ Tuchel 5-pol.	High Flex Leder	7S1FH046540330A00
	8 m	EDP	ZA - GZ Tuchel 5-pol.	High Flex Leder	7S1FH086540330A00
ABITIG® 17	4 m	EDP	ZA - GZ Tuchel 5-pol.	Standard	7S2SK046540330A00
	8 m	EDP	ZA - GZ Tuchel 5-pol.	Standard	7S2SK086540330A00
	4 m	EDP	ZA - GZ Tuchel 5-pol.	High Flex Leder	7S2SH046540330A00
	8 m	EDP	ZA - GZ Tuchel 5-pol.	High Flex Leder	7S2SH086540330A00
ABITIG® 17F	4 m	EDP	ZA - GZ Tuchel 5-pol.	Standard	7S2FK046540330A00
	8 m	EDP	ZA - GZ Tuchel 5-pol.	Standard	7S2FK086540330A00
	4 m	EDP	ZA - GZ Tuchel 5-pol.	High Flex Leder	7S2FH046540330A00
	8 m	EDP	ZA - GZ Tuchel 5-pol.	High Flex Leder	7S2FH086540330A00

Technische Änderungen vorbehalten • Verkaufspreise = unverbindliche Preisempfehlung - Angebot freibleibend • © Copyright

ABITIG® GRIP / ABITIG® GRIP Little-Brennerpreisliste

passend für WIG-Stromquellen des Fabrikates „merkle“

Brennertyp	Länge	Schalterfunktion	maschinenseitiger Anschluss	Schlauchpaketausführung	Bestellnummer
ABITIG® 26	4 m	EDP	ZA - GZ Tuchel 5-pol.	Standard	7S3SK046540330A00
	8 m	EDP	ZA - GZ Tuchel 5-pol.	Standard	7S3SK086540330A00
	4 m	EDP	ZA - GZ Tuchel 5-pol.	High Flex Leder	7S3SH046540330A00
	8 m	EDP	ZA - GZ Tuchel 5-pol.	High Flex Leder	7S3SH086540330A00
ABITIG® 26F	4 m	EDP	ZA - GZ Tuchel 5-pol.	Standard	7S3FK046540330A00
	8 m	EDP	ZA - GZ Tuchel 5-pol.	Standard	7S3FK086540330A00
	4 m	EDP	ZA - GZ Tuchel 5-pol.	High Flex Leder	7S3FH046540330A00
	8 m	EDP	ZA - GZ Tuchel 5-pol.	High Flex Leder	7S3FH086540330A00
ABITIG® 24G	4 m	EDP	ZA - GZ Tuchel 5-pol.	Standard	7S8SK046540330A00
	8 m	EDP	ZA - GZ Tuchel 5-pol.	Standard	7S8SK086540330A00
	4 m	EDP	ZA - GZ Tuchel 5-pol.	High Flex Leder	7S8SH046540330A00
	8 m	EDP	ZA - GZ Tuchel 5-pol.	High Flex Leder	7S8SH086540330A00
ABITIG® 200	4 m	EDP	ZA - GZ Tuchel 5-pol.	Standard	7T4SK046540330A00
	8 m	EDP	ZA - GZ Tuchel 5-pol.	Standard	7T4SK086540330A00
	4 m	EDP	ZA - GZ Tuchel 5-pol.	High Flex Leder	7T4SH046540330A00
	8 m	EDP	ZA - GZ Tuchel 5-pol.	High Flex Leder	7T4SH086540330A00
ABITIG® 200F	4 m	EDP	ZA - GZ Tuchel 5-pol.	Standard	7T4FK046540330A00
	8 m	EDP	ZA - GZ Tuchel 5-pol.	Standard	7T4FK086540330A00
	4 m	EDP	ZA - GZ Tuchel 5-pol.	High Flex Leder	7T4FH046540330A00
	8 m	EDP	ZA - GZ Tuchel 5-pol.	High Flex Leder	7T4FH086540330A00
ABITIG® 150	4 m	EDP	ZA - GZ Tuchel 5-pol.	Standard	7T6SK046540330A00
	8 m	EDP	ZA - GZ Tuchel 5-pol.	Standard	7T6SK086540330A00
	4 m	EDP	ZA - GZ Tuchel 5-pol.	High Flex Leder	7T6SH046540330A00
	8 m	EDP	ZA - GZ Tuchel 5-pol.	High Flex Leder	7T6SH086540330A00
ABITIG® 150F	4 m	EDP	ZA - GZ Tuchel 5-pol.	Standard	7T6FK046540330A00
	8 m	EDP	ZA - GZ Tuchel 5-pol.	Standard	7T6FK086540330A00
	4 m	EDP	ZA - GZ Tuchel 5-pol.	High Flex Leder	7T6FH046540330A00
	8 m	EDP	ZA - GZ Tuchel 5-pol.	High Flex Leder	7T6FH086540330A00

ABITIG® GRIP / ABITIG® GRIP Little-Brennerpreisliste

passend für WIG-Stromquellen des Fabrikates „merkle“

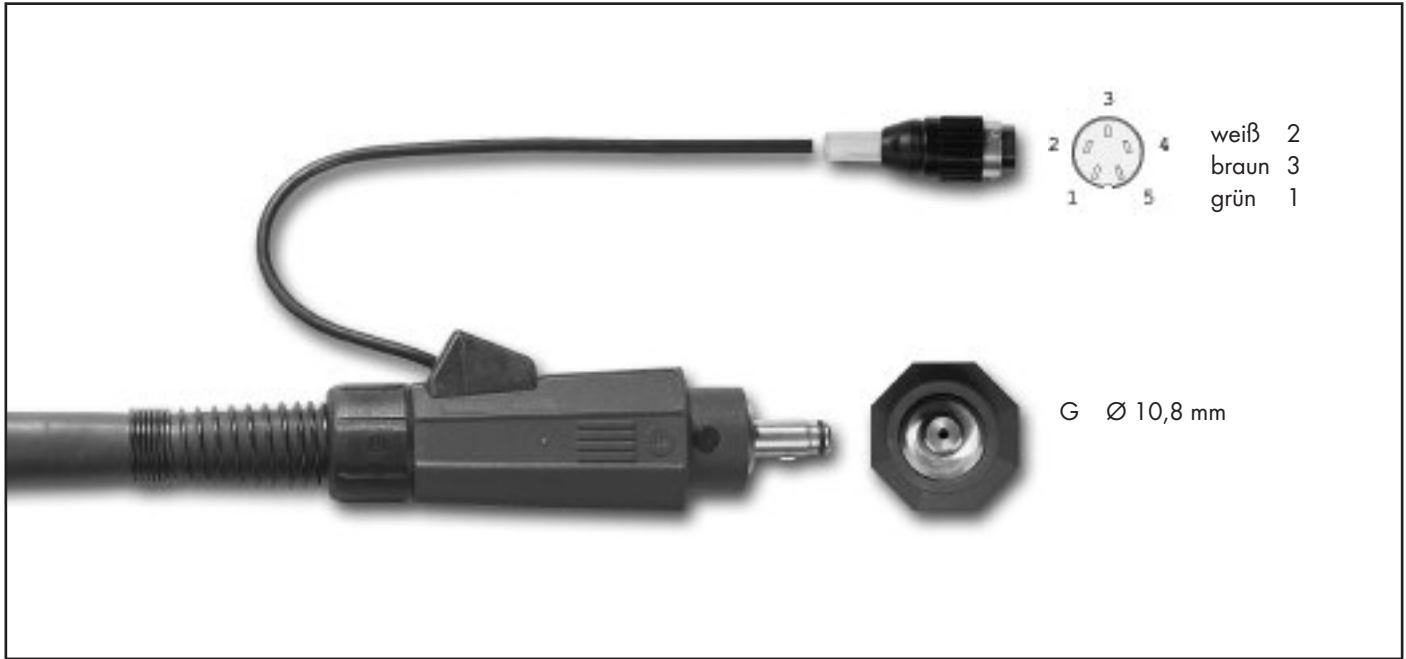

Brennertyp	Länge	Schalterfunktion	maschinenseitiger Anschluss	Schlauchpaketausführung	Bestellnummer
ABITIG® 9	4 m	DD	TCG Tuchel 5-pol.	Standard	7S1SK043523701A00
	8 m	DD	TCG Tuchel 5-pol.	Standard	7S1SK083523701A00
	4 m	DD	TCG Tuchel 5-pol.	High Flex Leder	7S1SH043523701A00
	8 m	DD	TCG Tuchel 5-pol.	High Flex Leder	7S1SH083523701A00
ABITIG® 9 Little	4 m	DD	TCG Tuchel 5-pol.	High Flex Leder	7L1SH043523701A00
	8 m	DD	TCG Tuchel 5-pol.	High Flex Leder	7L1SH083523701A00
ABITIG® 9F	4 m	DD	TCG Tuchel 5-pol.	Standard	7S1FK043523701A00
	8 m	DD	TCG Tuchel 5-pol.	Standard	7S1FK083523701A00
	4 m	DD	TCG Tuchel 5-pol.	High Flex Leder	7S1FH043523701A00
	8 m	DD	TCG Tuchel 5-pol.	High Flex Leder	7S1FH083523701A00
ABITIG® 9F Little	4 m	DD	TCG Tuchel 5-pol.	High Flex Leder	7L1FH043523701A00
	8 m	DD	TCG Tuchel 5-pol.	High Flex Leder	7L1FH083523701A00
ABITIG® 17	4 m	DD	TCG Tuchel 5-pol.	Standard	7S2SK043523701A00
	8 m	DD	TCG Tuchel 5-pol.	Standard	7S2SK083523701A00
	4 m	DD	TCG Tuchel 5-pol.	High Flex Leder	7S2SH043523701A00
	8 m	DD	TCG Tuchel 5-pol.	High Flex Leder	7S2SH083523701A00
ABITIG® 17 Little	4 m	DD	TCG Tuchel 5-pol.	High Flex Leder	7L2SH043523701A00
	8 m	DD	TCG Tuchel 5-pol.	High Flex Leder	7L2SH083523701A00
ABITIG® 17F	4 m	DD	TCG Tuchel 5-pol.	Standard	7S2FK043523701A00
	8 m	DD	TCG Tuchel 5-pol.	Standard	7S2FK083523701A00
	4 m	DD	TCG Tuchel 5-pol.	High Flex Leder	7S2FH043523701A00
	8 m	DD	TCG Tuchel 5-pol.	High Flex Leder	7S2FH083523701A00
ABITIG® 17F Little	4 m	DD	TCG Tuchel 5-pol.	High Flex Leder	7L2FH043523701A00
	8 m	DD	TCG Tuchel 5-pol.	High Flex Leder	7L2FH083523701A00

Technische Änderungen vorbehalten • Verkaufspreise = unverbindliche Preisempfehlung - Angebot freibleibend • © Copyright

ABITIG® GRIP / ABITIG® GRIP Little-Brennerpreisliste

passend für WIG-Stromquellen des Fabrikates „merkle“

Brennertyp	Länge	Schalterfunktion	maschinenseitiger Anschluss	Schlauchpaketausführung	Bestellnummer
ABITIG® 26	4 m	DD	TCG Tuchel 5-pol.	Standard	7S3SK043523701A00
	8 m	DD	TCG Tuchel 5-pol.	Standard	7S3SK083523701A00
	4 m	DD	TCG Tuchel 5-pol.	High Flex Leder	7S3SH043523701A00
	8 m	DD	TCG Tuchel 5-pol.	High Flex Leder	7S3SH083523701A00
ABITIG® 26F	4 m	DD	TCG Tuchel 5-pol.	Standard	7S3FK043523701A00
	8 m	DD	TCG Tuchel 5-pol.	Standard	7S3FK083523701A00
	4 m	DD	TCG Tuchel 5-pol.	High Flex Leder	7S3FH043523701A00
	8 m	DD	TCG Tuchel 5-pol.	High Flex Leder	7S3FH083523701A00
ABITIG® 24G	4 m	DD	TCG Tuchel 5-pol.	Standard	7S8SK043523701A00
	8 m	DD	TCG Tuchel 5-pol.	Standard	7S8SK083523701A00
	4 m	DD	TCG Tuchel 5-pol.	High Flex Leder	7S8SH043523701A00
	8 m	DD	TCG Tuchel 5-pol.	High Flex Leder	7S8SH083523701A00
ABITIG® 24G Little	4 m	DD	TCG Tuchel 5-pol.	High Flex Leder	7L8SH043523701A00
	8 m	DD	TCG Tuchel 5-pol.	High Flex Leder	7L8SH083523701A00
ABITIG® 200	4 m	DD	TCG Tuchel 5-pol.	Standard	7T4SK043523701A00
	8 m	DD	TCG Tuchel 5-pol.	Standard	7T4SK083523701A00
	4 m	DD	TCG Tuchel 5-pol.	High Flex Leder	7T4SH043523701A00
	8 m	DD	TCG Tuchel 5-pol.	High Flex Leder	7T4SH083523701A00
ABITIG® 200F	4 m	DD	TCG Tuchel 5-pol.	Standard	7T4FK043523701A00
	8 m	DD	TCG Tuchel 5-pol.	Standard	7T4FK083523701A00
	4 m	DD	TCG Tuchel 5-pol.	High Flex Leder	7T4FH043523701A00
	8 m	DD	TCG Tuchel 5-pol.	High Flex Leder	7T4FH083523701A00
ABITIG® 150	4 m	DD	TCG Tuchel 5-pol.	Standard	7T6SK043523701A00
	8 m	DD	TCG Tuchel 5-pol.	Standard	7T6SK083523701A00
	4 m	DD	TCG Tuchel 5-pol.	High Flex Leder	7T6SH043523701A00
	8 m	DD	TCG Tuchel 5-pol.	High Flex Leder	7T6SH083523701A00
ABITIG® 150 Little	4 m	DD	TCG Tuchel 5-pol.	High Flex Leder	7L6SH043523701A00
	8 m	DD	TCG Tuchel 5-pol.	High Flex Leder	7L6SH083523701A00
ABITIG® 150F	4 m	DD	TCG Tuchel 5-pol.	Standard	7T6FK043523701A00
	8 m	DD	TCG Tuchel 5-pol.	Standard	7T6FK083523701A00
	4 m	DD	TCG Tuchel 5-pol.	High Flex Leder	7T6FH043523701A00
	8 m	DD	TCG Tuchel 5-pol.	High Flex Leder	7T6FH083523701A00
ABITIG® 150F Little	4 m	DD	TCG Tuchel 5-pol.	High Flex Leder	7L6FH043523701A00
	8 m	DD	TCG Tuchel 5-pol.	High Flex Leder	7L6FH083523701A00

ABITIG® GRIP / ABITIG® GRIP Little-Brennerpreisliste

passend für WIG-Stromquellen des Fabrikates „merkle“

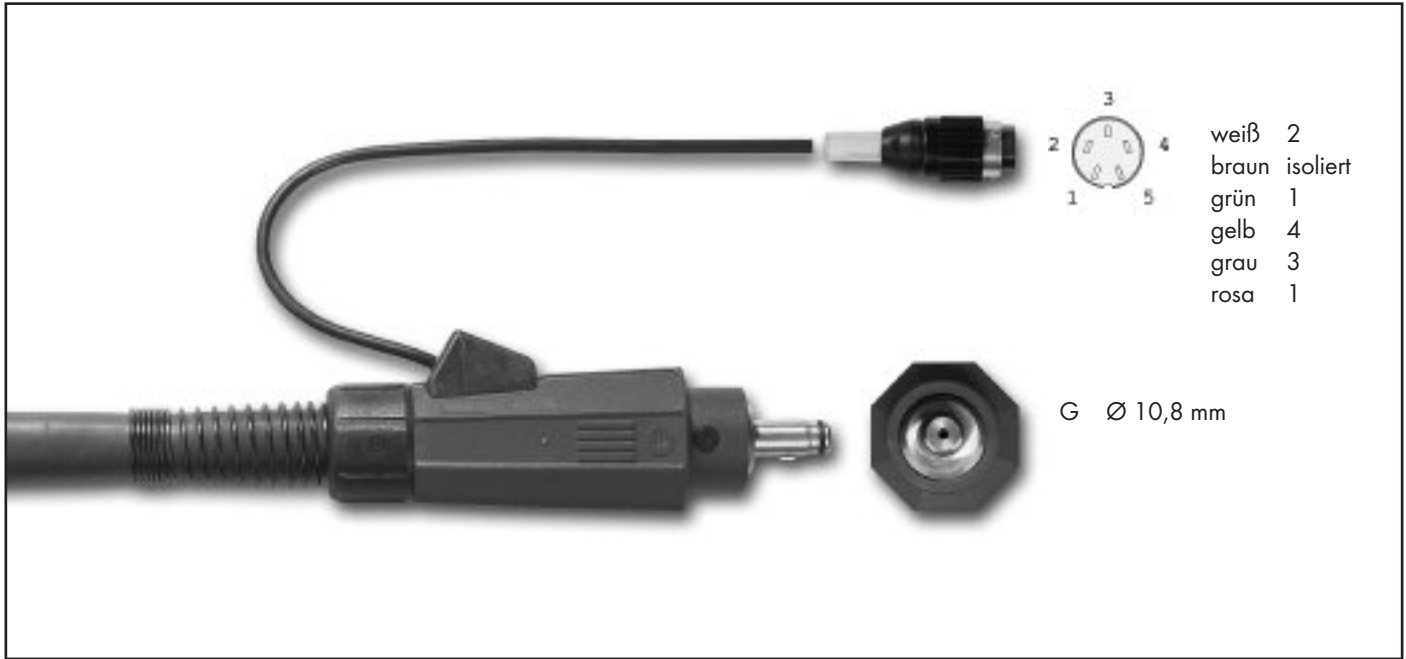

Brennertyp	Länge	Schalterfunktion	maschinenseitiger Anschluss	Schlauchpaketausführung	Bestellnummer
ABITIG® 9	4 m	EDP	TCG Tuchel 5-pol.	Standard	7S1SK046543730A00
	8 m	EDP	TCG Tuchel 5-pol.	Standard	7S1SK086543730A00
	4 m	EDP	TCG Tuchel 5-pol.	High Flex Leder	7S1SH046543730A00
	8 m	EDP	TCG Tuchel 5-pol.	High Flex Leder	7S1SH086543730A00
ABITIG® 9F	4 m	EDP	TCG Tuchel 5-pol.	Standard	7S1FK046543730A00
	8 m	EDP	TCG Tuchel 5-pol.	Standard	7S1FK086543730A00
	4 m	EDP	TCG Tuchel 5-pol.	High Flex Leder	7S1FH046543730A00
	8 m	EDP	TCG Tuchel 5-pol.	High Flex Leder	7S1FH086543730A00
ABITIG® 17	4 m	EDP	TCG Tuchel 5-pol.	Standard	7S2SK046543730A00
	8 m	EDP	TCG Tuchel 5-pol.	Standard	7S2SK086543730A00
	4 m	EDP	TCG Tuchel 5-pol.	High Flex Leder	7S2SH046543730A00
	8 m	EDP	TCG Tuchel 5-pol.	High Flex Leder	7S2SH086543730A00
ABITIG® 17F	4 m	EDP	TCG Tuchel 5-pol.	Standard	7S2FK046543730A00
	8 m	EDP	TCG Tuchel 5-pol.	Standard	7S2FK086543730A00
	4 m	EDP	TCG Tuchel 5-pol.	High Flex Leder	7S2FH046543730A00
	8 m	EDP	TCG Tuchel 5-pol.	High Flex Leder	7S2FH086543730A00

Technische Änderungen vorbehalten • Verkaufspreise = unverbindliche Preisempfehlung - Angebot freibleibend • © Copyright

ABITIG® GRIP / ABITIG® GRIP Little-Brennerpreisliste

passend für WIG-Stromquellen des Fabrikates „merkle“

Brennertyp	Länge	Schalterfunktion	maschinenseitiger Anschluss	Schlauchpaketausführung	Bestellnummer
ABITIG® 26	4 m	EDP	TCG Tuchel 5-pol.	Standard	7S3SK046543730A00
	8 m	EDP	TCG Tuchel 5-pol.	Standard	7S3SK086543730A00
	4 m	EDP	TCG Tuchel 5-pol.	High Flex Leder	7S3SH046543730A00
	8 m	EDP	TCG Tuchel 5-pol.	High Flex Leder	7S3SH086543730A00
ABITIG® 26F	4 m	EDP	TCG Tuchel 5-pol.	Standard	7S3FK046543730A00
	8 m	EDP	TCG Tuchel 5-pol.	Standard	7S3FK086543730A00
	4 m	EDP	TCG Tuchel 5-pol.	High Flex Leder	7S3FH046543730A00
	8 m	EDP	TCG Tuchel 5-pol.	High Flex Leder	7S3FH086543730A00
ABITIG® 24G	4 m	EDP	TCG Tuchel 5-pol.	Standard	7S8SK046543730A00
	8 m	EDP	TCG Tuchel 5-pol.	Standard	7S8SK086543730A00
	4 m	EDP	TCG Tuchel 5-pol.	High Flex Leder	7S8SH046543730A00
	8 m	EDP	TCG Tuchel 5-pol.	High Flex Leder	7L8SH086543730A00
ABITIG® 200	4 m	EDP	TCG Tuchel 5-pol.	Standard	7T4SK046543730A00
	8 m	EDP	TCG Tuchel 5-pol.	Standard	7T4SK086543730A00
	4 m	EDP	TCG Tuchel 5-pol.	High Flex Leder	7T4SH046543730A00
	8 m	EDP	TCG Tuchel 5-pol.	High Flex Leder	7T4SH086543730A00
ABITIG® 200F	4 m	EDP	TCG Tuchel 5-pol.	Standard	7T4FK046543730A00
	8 m	EDP	TCG Tuchel 5-pol.	Standard	7T4FK086543730A00
	4 m	EDP	TCG Tuchel 5-pol.	High Flex Leder	7T4FH046543730A00
	8 m	EDP	TCG Tuchel 5-pol.	High Flex Leder	7T4FH086543730A00
ABITIG® 150	4 m	EDP	TCG Tuchel 5-pol.	Standard	7T6SK046543730A00
	8 m	EDP	TCG Tuchel 5-pol.	Standard	7T6SK086543730A00
	4 m	EDP	TCG Tuchel 5-pol.	High Flex Leder	7T6SH046543730A00
	8 m	EDP	TCG Tuchel 5-pol.	High Flex Leder	7T6SH086543730A00
ABITIG® 150F	4 m	EDP	TCG Tuchel 5-pol.	Standard	7T6FK046543730A00
	8 m	EDP	TCG Tuchel 5-pol.	Standard	7T6FK086543730A00
	4 m	EDP	TCG Tuchel 5-pol.	High Flex Leder	7T6FH046543730A00
	8 m	EDP	TCG Tuchel 5-pol.	High Flex Leder	7T6FH086543730A00

ABITIG® GRIP / ABITIG® GRIP Little-Brennerpreisliste

passend für WIG-Stromquellen des Fabrikates „merkle“ PU 250/300 K



Brennertyp	Länge	Schalterfunktion	maschinenseitiger Anschluss	Schlauchpaketausführung	Bestellnummer
ABITIG® 9	4 m	ED	MAG - ZA	Standard	7S1SK043513496A00
	8 m	ED	MAG - ZA	Standard	7S1SK083513496A00
	4 m	ED	MAG - ZA	High Flex Leder	7S1SH043513496A00
	8 m	ED	MAG - ZA	High Flex Leder	7S1SH083513496A00
ABITIG® 9 Little	4 m	ED	MAG - ZA	High Flex Leder	7L1SH043513496A00
	8 m	ED	MAG - ZA	High Flex Leder	7L1SH083513496A00
ABITIG® 9F	4 m	ED	MAG - ZA	Standard	7S1FK043513496A00
	8 m	ED	MAG - ZA	Standard	7S1FK083513496A00
	4 m	ED	MAG - ZA	High Flex Leder	7S1FH043513496A00
	8 m	ED	MAG - ZA	High Flex Leder	7S1FH083513496A00
ABITIG® 9F Little	4 m	ED	MAG - ZA	High Flex Leder	7L1FH043513496A00
	8 m	ED	MAG - ZA	High Flex Leder	7L1FH083513496A00
ABITIG® 17	4 m	ED	MAG - ZA	Standard	7S2SK043513496A00
	8 m	ED	MAG - ZA	Standard	7S2SK083513496A00
	4 m	ED	MAG - ZA	High Flex Leder	7S2SH043513496A00
	8 m	ED	MAG - ZA	High Flex Leder	7S2SH083513496A00
ABITIG® 17 Little	4 m	ED	MAG - ZA	High Flex Leder	7L2SH043513496A00
	8 m	ED	MAG - ZA	High Flex Leder	7L2SH083513496A00
ABITIG® 17F	4 m	ED	MAG - ZA	Standard	7S2FK043513496A00
	8 m	ED	MAG - ZA	Standard	7S2FK083513496A00
	4 m	ED	MAG - ZA	High Flex Leder	7S2FH043513496A00
	8 m	ED	MAG - ZA	High Flex Leder	7S2FH083513496A00
ABITIG® 17F Little	4 m	ED	MAG - ZA	High Flex Leder	7L2FH043513496A00
	8 m	ED	MAG - ZA	High Flex Leder	7L2FH083513496A00

Technische Änderungen vorbehalten • Verkaufspreise = unverbindliche Preisempfehlung - Angebot freibleibend • © Copyright

ABITIG® GRIP / ABITIG® GRIP Little-Brennerpreisliste

passend für WIG-Stromquellen des Fabrikates „merkle“ PU 250/300 K

Brennertyp	Länge	Schalterfunktion	maschinenseitiger Anschluss	Schlauchpaketausführung	Bestellnummer
ABITIG® 26	4 m	ED	MAG - ZA	Standard	7S3SK043513496A00
	8 m	ED	MAG - ZA	Standard	7S3SK083513496A00
	4 m	ED	MAG - ZA	High Flex Leder	7S3SH043513496A00
	8 m	ED	MAG - ZA	High Flex Leder	7S3SH083513496A00
ABITIG® 26F	4 m	ED	MAG - ZA	Standard	7S3FK043513496A00
	8 m	ED	MAG - ZA	Standard	7S3FK083513496A00
	4 m	ED	MAG - ZA	High Flex Leder	7S3FH043513496A00
	8 m	ED	MAG - ZA	High Flex Leder	7S3FH083513496A00
ABITIG® 24G	4 m	ED	MAG - ZA	Standard	7S8SK043513496A00
	8 m	ED	MAG - ZA	Standard	7S8SK083513496A00
	4 m	ED	MAG - ZA	High Flex Leder	7S8SH043513496A00
	8 m	ED	MAG - ZA	High Flex Leder	7S8SH083513496A00
ABITIG® 24G Little	4 m	ED	MAG - ZA	High Flex Leder	7L8SH043513496A00
	8 m	ED	MAG - ZA	High Flex Leder	7L8SH083513496A00
ABITIG® 200	4 m	ED	MAG - ZA	Standard	7T4SK043513496A00
	8 m	ED	MAG - ZA	Standard	7T4SK083513496A00
	4 m	ED	MAG - ZA	High Flex Leder	7T4SH043513496A00
	8 m	ED	MAG - ZA	High Flex Leder	7T4SH083513496A00
ABITIG® 200F	4 m	ED	MAG - ZA	Standard	7T4FK043513496A00
	8 m	ED	MAG - ZA	Standard	7T4FK083513496A00
	4 m	ED	MAG - ZA	High Flex Leder	7T4FH043513496A00
	8 m	ED	MAG - ZA	High Flex Leder	7T4FH083513496A00
ABITIG® 150	4 m	ED	MAG - ZA	Standard	7T6SK043513496A00
	8 m	ED	MAG - ZA	Standard	7T6SK083513496A00
	4 m	ED	MAG - ZA	High Flex Leder	7T6SH043513496A00
	8 m	ED	MAG - ZA	High Flex Leder	7T6SH083513496A00
ABITIG® 150 Little	4 m	ED	MAG - ZA	High Flex Leder	7L6SH043513496A00
	8 m	ED	MAG - ZA	High Flex Leder	7L6SH083513496A00
ABITIG® 150F	4 m	ED	MAG - ZA	Standard	7T6FK043513496A00
	8 m	ED	MAG - ZA	Standard	7T6FK083513496A00
	4 m	ED	MAG - ZA	High Flex Leder	7T6FH043513496A00
	8 m	ED	MAG - ZA	High Flex Leder	7T6FH083513496A00
ABITIG® 150F Little	4 m	ED	MAG - ZA	High Flex Leder	7L6FH043513496A00
	8 m	ED	MAG - ZA	High Flex Leder	7L6FH083513496A00

ABITIG® GRIP / ABITIG® GRIP Little-Brennerpreisliste

passend für WIG-Stromquellen des Fabrikates „merkle“



Brennertyp	Länge	Schalterfunktion	maschinenseitiger Anschluss	Schlauchpaketausführung	Bestellnummer
ABITIG® 18	4 m	ED/DD	ZA - WZ-0 Tuchel 3-pol.	Standard	7S4SK043520313A12
	8 m	ED/DD	ZA - WZ-0 Tuchel 3-pol.	Standard	7S4SK083520313A12
	4 m	ED/DD	ZA - WZ-0 Tuchel 3-pol.	High Flex Leder	7S4SH043520313A12
	8 m	ED/DD	ZA - WZ-0 Tuchel 3-pol.	High Flex Leder	7S4SH083520313A12
ABITIG® 18F	4 m	ED/DD	ZA - WZ-0 Tuchel 3-pol.	Standard	7S4FK043520313A12
	8 m	ED/DD	ZA - WZ-0 Tuchel 3-pol.	Standard	7S4FK083520313A12
	4 m	ED/DD	ZA - WZ-0 Tuchel 3-pol.	High Flex Leder	7S4FH043520313A12
	8 m	ED/DD	ZA - WZ-0 Tuchel 3-pol.	High Flex Leder	7S4FH083520313A12
ABITIG® 20	4 m	ED/DD	ZA - WZ-0 Tuchel 3-pol.	Standard	7S5SK043520313A12
	8 m	ED/DD	ZA - WZ-0 Tuchel 3-pol.	Standard	7S5SK083520313A12
	4 m	ED/DD	ZA - WZ-0 Tuchel 3-pol.	High Flex Leder	7S5SH043520313A12
	8 m	ED/DD	ZA - WZ-0 Tuchel 3-pol.	High Flex Leder	7S5SH083520313A12
ABITIG® 20 Little	4 m	ED/DD	ZA - WZ-0 Tuchel 3-pol.	High Flex Leder	7L5SH043520313A12
	8 m	ED/DD	ZA - WZ-0 Tuchel 3-pol.	High Flex Leder	7L5SH083520313A12
ABITIG® 20F	4 m	ED/DD	ZA - WZ-0 Tuchel 3-pol.	Standard	7S5FK043520313A12
	8 m	ED/DD	ZA - WZ-0 Tuchel 3-pol.	Standard	7S5FK083520313A12
	4 m	ED/DD	ZA - WZ-0 Tuchel 3-pol.	High Flex Leder	7S5FH043520313A12
	8 m	ED/DD	ZA - WZ-0 Tuchel 3-pol.	High Flex Leder	7S5FH083520313A12
ABITIG® 20F Little	4 m	ED/DD	ZA - WZ-0 Tuchel 3-pol.	High Flex Leder	7L5FH043520313A12
	8 m	ED/DD	ZA - WZ-0 Tuchel 3-pol.	High Flex Leder	7L5FH083520313A12

Technische Änderungen vorbehalten • Verkaufspreise = unverbindliche Preisempfehlung - Angebot freibleibend • © Copyright

ABITIG® GRIP / ABITIG® GRIP Little-Brennerpreisliste

passend für WIG-Stromquellen des Fabrikates „merkle“

Brennertyp	Länge	Schalterfunktion	maschinenseitiger Anschluss	Schlauchpaketausführung	Bestellnummer
ABITIG® 12-1	4 m	ED/DD	ZA - WZ-0 Tuchel 3-pol.	Standard	7S6SK043520313A12
	8 m	ED/DD	ZA - WZ-0 Tuchel 3-pol.	Standard	7S6SK083520313A12
	4 m	ED/DD	ZA - WZ-0 Tuchel 3-pol.	High Flex Leder	7S6SH043520313A12
	8 m	ED/DD	ZA - WZ-0 Tuchel 3-pol.	High Flex Leder	7S6SH083520313A12
ABITIG® 18SC	4 m	ED/DD	ZA - WZ-0 Tuchel 3-pol.	Standard	7S7SK043520313A12
	8 m	ED/DD	ZA - WZ-0 Tuchel 3-pol.	Standard	7S7SK083520313A12
	4 m	ED/DD	ZA - WZ-0 Tuchel 3-pol.	High Flex Leder	7S7SH043520313A12
	8 m	ED/DD	ZA - WZ-0 Tuchel 3-pol.	High Flex Leder	7S7SH083520313A12
ABITIG® 24W	4 m	ED/DD	ZA - WZ-0 Tuchel 3-pol.	Standard	7S9SK043520313A12
	8 m	ED/DD	ZA - WZ-0 Tuchel 3-pol.	Standard	7S9SK083520313A12
	4 m	ED/DD	ZA - WZ-0 Tuchel 3-pol.	High Flex Leder	7S9SH043520313A12
	8 m	ED/DD	ZA - WZ-0 Tuchel 3-pol.	High Flex Leder	7S9SH083520313A12
ABITIG® 24W Little	4 m	ED/DD	ZA - WZ-0 Tuchel 3-pol.	High Flex Leder	7L9SH043520313A12
	8 m	ED/DD	ZA - WZ-0 Tuchel 3-pol.	High Flex Leder	7L9SH083520313A12
ABITIG® 450W	4 m	ED/DD	ZA - WZ-0 Tuchel 3-pol.	Standard	7T5SK043520313A12
	8 m	ED/DD	ZA - WZ-0 Tuchel 3-pol.	Standard	7T5SK083520313A12
	4 m	ED/DD	ZA - WZ-0 Tuchel 3-pol.	High Flex Leder	7T5SH043520313A12
	8 m	ED/DD	ZA - WZ-0 Tuchel 3-pol.	High Flex Leder	7T5SH083520313A12
ABITIG® 260W	4 m	ED/DD	ZA - WZ-0 Tuchel 3-pol.	Standard	7T7SK043520313A12
	8 m	ED/DD	ZA - WZ-0 Tuchel 3-pol.	Standard	7T7SK083520313A12
	4 m	ED/DD	ZA - WZ-0 Tuchel 3-pol.	High Flex Leder	7T7SH043520313A12
	8 m	ED/DD	ZA - WZ-0 Tuchel 3-pol.	High Flex Leder	7T7SH083520313A12
ABITIG® 260W Little	4 m	ED/DD	ZA - WZ-0 Tuchel 3-pol.	High Flex Leder	7L7SH043520313A12
	8 m	ED/DD	ZA - WZ-0 Tuchel 3-pol.	High Flex Leder	7L7SH083520313A12
ABITIG® 450W SC	4 m	ED/DD	ZA - WZ-0 Tuchel 3-pol.	Standard	
	8 m	ED/DD	ZA - WZ-0 Tuchel 3-pol.	Standard	
	4 m	ED/DD	ZA - WZ-0 Tuchel 3-pol.	High Flex Leder	7T8SH043520313A12
	8 m	ED/DD	ZA - WZ-0 Tuchel 3-pol.	High Flex Leder	7T8SH083520313A12

ABITIG® GRIP / ABITIG® GRIP Little-Brennerpreisliste

passend für WIG-Stromquellen des Fabrikates „merkle“



Brennertyp	Länge	Schalterfunktion	maschinenseitiger Anschluss	Schlauchpaketausführung	Bestellnummer
ABITIG® 18	4 m	DD	ZA - WZ-0 Tuchel 5-pol.	Standard	7S4SK043520301A12
	8 m	DD	ZA - WZ-0 Tuchel 5-pol.	Standard	7S4SK083520301A12
	4 m	DD	ZA - WZ-0 Tuchel 5-pol.	High Flex Leder	7S4SH043520301A12
	8 m	DD	ZA - WZ-0 Tuchel 5-pol.	High Flex Leder	7S4SH083520301A12
ABITIG® 18F	4 m	DD	ZA - WZ-0 Tuchel 5-pol.	Standard	7S4FK043520301A12
	8 m	DD	ZA - WZ-0 Tuchel 5-pol.	Standard	7S4FK083520301A12
	4 m	DD	ZA - WZ-0 Tuchel 5-pol.	High Flex Leder	7S4FH043520301A12
	8 m	DD	ZA - WZ-0 Tuchel 5-pol.	High Flex Leder	7S4FH083520301A12
ABITIG® 20	4 m	DD	ZA - WZ-0 Tuchel 5-pol.	Standard	7S5SK043520301A12
	8 m	DD	ZA - WZ-0 Tuchel 5-pol.	Standard	7S5SK083520301A12
	4 m	DD	ZA - WZ-0 Tuchel 5-pol.	High Flex Leder	7S5SH043520301A12
	8 m	DD	ZA - WZ-0 Tuchel 5-pol.	High Flex Leder	7S5SH083520301A12
ABITIG® 20 Little	4 m	DD	ZA - WZ-0 Tuchel 5-pol.	High Flex Leder	7L5SH043520301A12
	8 m	DD	ZA - WZ-0 Tuchel 5-pol.	High Flex Leder	7L5SH083520301A12
ABITIG® 20F	4 m	DD	ZA - WZ-0 Tuchel 5-pol.	Standard	7S5FK043520301A12
	8 m	DD	ZA - WZ-0 Tuchel 5-pol.	Standard	7S5FK083520301A12
	4 m	DD	ZA - WZ-0 Tuchel 5-pol.	High Flex Leder	7S5FH043520301A12
	8 m	DD	ZA - WZ-0 Tuchel 5-pol.	High Flex Leder	7S5FH083520301A12
ABITIG® 20F Little	4 m	DD	ZA - WZ-0 Tuchel 5-pol.	High Flex Leder	7L5FH043520301A12
	8 m	DD	ZA - WZ-0 Tuchel 5-pol.	High Flex Leder	7L5FH083520301A12

Technische Änderungen vorbehalten • Verkaufspreise = unverbindliche Preisempfehlung - Angebot freibleibend • © Copyright

ABITIG® GRIP / ABITIG® GRIP Little-Brennerpreisliste

passend für WIG-Stromquellen des Fabrikates „merkle“

Brennertyp	Länge	Schalterfunktion	maschinenseitiger Anschluss	Schlauchpaketausführung	Bestellnummer
ABITIG® 12-1	4 m	DD	ZA - WZ-0 Tuchel 5-pol.	Standard	7S6SK043520301A12
	8 m	DD	ZA - WZ-0 Tuchel 5-pol.	Standard	7S6SK083520301A12
	4 m	DD	ZA - WZ-0 Tuchel 5-pol.	High Flex Leder	7S6SH043520301A12
	8 m	DD	ZA - WZ-0 Tuchel 5-pol.	High Flex Leder	7S6SH083520301A12
ABITIG® 18SC	4 m	DD	ZA - WZ-0 Tuchel 5-pol.	Standard	7S7SK043520301A12
	8 m	DD	ZA - WZ-0 Tuchel 5-pol.	Standard	7S7SK083520301A12
	4 m	DD	ZA - WZ-0 Tuchel 5-pol.	High Flex Leder	7S7SH043520301A12
	8 m	DD	ZA - WZ-0 Tuchel 5-pol.	High Flex Leder	7S7SH083520301A12
ABITIG® 24W	4 m	DD	ZA - WZ-0 Tuchel 5-pol.	Standard	7S9SK043520301A12
	8 m	DD	ZA - WZ-0 Tuchel 5-pol.	Standard	7S9SK083520301A12
	4 m	DD	ZA - WZ-0 Tuchel 5-pol.	High Flex Leder	7S9SH043520301A12
	8 m	DD	ZA - WZ-0 Tuchel 5-pol.	High Flex Leder	7S9SH083520301A12
ABITIG® 24W Little	4 m	DD	ZA - WZ-0 Tuchel 5-pol.	High Flex Leder	7L9SH043520301A12
	8 m	DD	ZA - WZ-0 Tuchel 5-pol.	High Flex Leder	7L9SH083520301A12
ABITIG® 450W	4 m	DD	ZA - WZ-0 Tuchel 5-pol.	Standard	7T5SK043520301A12
	8 m	DD	ZA - WZ-0 Tuchel 5-pol.	Standard	7T5SK083520301A12
	4 m	DD	ZA - WZ-0 Tuchel 5-pol.	High Flex Leder	7T5SH043520301A12
	8 m	DD	ZA - WZ-0 Tuchel 5-pol.	High Flex Leder	7T5SH083520301A12
ABITIG® 260W	4 m	DD	ZA - WZ-0 Tuchel 5-pol.	Standard	7T7SK043520301A12
	8 m	DD	ZA - WZ-0 Tuchel 5-pol.	Standard	7T7SK083520301A12
	4 m	DD	ZA - WZ-0 Tuchel 5-pol.	High Flex Leder	7T7SH043520301A12
	8 m	DD	ZA - WZ-0 Tuchel 5-pol.	High Flex Leder	7T7SH083520301A12
ABITIG® 260W Little	4 m	DD	ZA - WZ-0 Tuchel 5-pol.	High Flex Leder	7L7SH043520301A12
	8 m	DD	ZA - WZ-0 Tuchel 5-pol.	High Flex Leder	7L7SH083520301A12
ABITIG® 450W SC	4 m	DD	ZA - WZ-0 Tuchel 5-pol.	Standard	
	8 m	DD	ZA - WZ-0 Tuchel 5-pol.	Standard	
	4 m	DD	ZA - WZ-0 Tuchel 5-pol.	High Flex Leder	7T8SH043520301A12
	8 m	DD	ZA - WZ-0 Tuchel 5-pol.	High Flex Leder	7T8SH083520301A12

ABITIG® GRIP / ABITIG® GRIP Little-Brennerpreisliste

passend für WIG-Stromquellen des Fabrikates „merkle“



Brennertyp	Länge	Schalterfunktion	maschinenseitiger Anschluss	Schlauchpaketausführung	Bestellnummer
ABITIG® 18	4 m	EDP	ZA - WZ-0 Tuchel 5-pol.	Standard	7S4SK046540330A12
	8 m	EDP	ZA - WZ-0 Tuchel 5-pol.	Standard	7S4SK086540330A12
	4 m	EDP	ZA - WZ-0 Tuchel 5-pol.	High Flex Leder	7S4SH046540330A12
	8 m	EDP	ZA - WZ-0 Tuchel 5-pol.	High Flex Leder	7S4SH086540330A12
ABITIG® 18F	4 m	EDP	ZA - WZ-0 Tuchel 5-pol.	Standard	7S4FK046540330A12
	8 m	EDP	ZA - WZ-0 Tuchel 5-pol.	Standard	7S4FK086540330A12
	4 m	EDP	ZA - WZ-0 Tuchel 5-pol.	High Flex Leder	7S4FH046540330A12
	8 m	EDP	ZA - WZ-0 Tuchel 5-pol.	High Flex Leder	7S4FH086540330A12
ABITIG® 20	4 m	EDP	ZA - WZ-0 Tuchel 5-pol.	Standard	7S5SK046540330A12
	8 m	EDP	ZA - WZ-0 Tuchel 5-pol.	Standard	7S5SK086540330A12
	4 m	EDP	ZA - WZ-0 Tuchel 5-pol.	High Flex Leder	7S5SH046540330A12
	8 m	EDP	ZA - WZ-0 Tuchel 5-pol.	High Flex Leder	7S5SH086540330A12
ABITIG® 20F	4 m	EDP	ZA - WZ-0 Tuchel 5-pol.	Standard	7S5FK046540330A12
	8 m	EDP	ZA - WZ-0 Tuchel 5-pol.	Standard	7S5FK086540330A12
	4 m	EDP	ZA - WZ-0 Tuchel 5-pol.	High Flex Leder	7S5FH046540330A12
	8 m	EDP	ZA - WZ-0 Tuchel 5-pol.	High Flex Leder	7S5FH086540330A12

Technische Änderungen vorbehalten • Verkaufspreise = unverbindliche Preisempfehlung - Angebot freibleibend • © Copyright

ABITIG® GRIP / ABITIG® GRIP Little-Brennerpreisliste

passend für WIG-Stromquellen des Fabrikates „merkle“

Brennertyp	Länge	Schalterfunktion	maschinenseitiger Anschluss	Schlauchpaketausführung	Bestellnummer
ABITIG® 12-1	4 m	EDP	ZA - WZ-0 Tuchel 5-pol.	Standard	7S6SK046540330A12
	8 m	EDP	ZA - WZ-0 Tuchel 5-pol.	Standard	7S6SK086540330A12
	4 m	EDP	ZA - WZ-0 Tuchel 5-pol.	High Flex Leder	7S6SH046540330A12
	8 m	EDP	ZA - WZ-0 Tuchel 5-pol.	High Flex Leder	7S6SH086540330A12
ABITIG® 18SC	4 m	EDP	ZA - WZ-0 Tuchel 5-pol.	Standard	7S7SK046540330A12
	8 m	EDP	ZA - WZ-0 Tuchel 5-pol.	Standard	7S7SK086540330A12
	4 m	EDP	ZA - WZ-0 Tuchel 5-pol.	High Flex Leder	7S7SH046540330A12
	8 m	EDP	ZA - WZ-0 Tuchel 5-pol.	High Flex Leder	7S7SH086540330A12
ABITIG® 24W	4 m	EDP	ZA - WZ-0 Tuchel 5-pol.	Standard	7S9SK046540330A12
	8 m	EDP	ZA - WZ-0 Tuchel 5-pol.	Standard	7S9SK086540330A12
	4 m	EDP	ZA - WZ-0 Tuchel 5-pol.	High Flex Leder	7S9SH046540330A12
	8 m	EDP	ZA - WZ-0 Tuchel 5-pol.	High Flex Leder	7S9SH086540330A12
ABITIG® 450W	4 m	EDP	ZA - WZ-0 Tuchel 5-pol.	Standard	7T5SK046540330A12
	8 m	EDP	ZA - WZ-0 Tuchel 5-pol.	Standard	7T5SK086540330A12
	4 m	EDP	ZA - WZ-0 Tuchel 5-pol.	High Flex Leder	7T5SH046540330A12
	8 m	EDP	ZA - WZ-0 Tuchel 5-pol.	High Flex Leder	7T5SH086540330A12
ABITIG® 260W	4 m	EDP	ZA - WZ-0 Tuchel 5-pol.	Standard	7T7SK046540330A12
	8 m	EDP	ZA - WZ-0 Tuchel 5-pol.	Standard	7T7SK086540330A12
	4 m	EDP	ZA - WZ-0 Tuchel 5-pol.	High Flex Leder	7T7SH046540330A12
	8 m	EDP	ZA - WZ-0 Tuchel 5-pol.	High Flex Leder	7T7SH086540330A12
ABITIG® 450W SC	4 m	EDP	ZA - WZ-0 Tuchel 5-pol.	Standard	
	8 m	EDP	ZA - WZ-0 Tuchel 5-pol.	Standard	
	4 m	EDP	ZA - WZ-0 Tuchel 5-pol.	High Flex Leder	7T8SH046540330A12
	8 m	EDP	ZA - WZ-0 Tuchel 5-pol.	High Flex Leder	7T8SH086540330A12

ABITIG® GRIP / ABITIG® GRIP Little-Brennerpreisliste

passend für WIG-Stromquellen des Fabrikates „merkle“

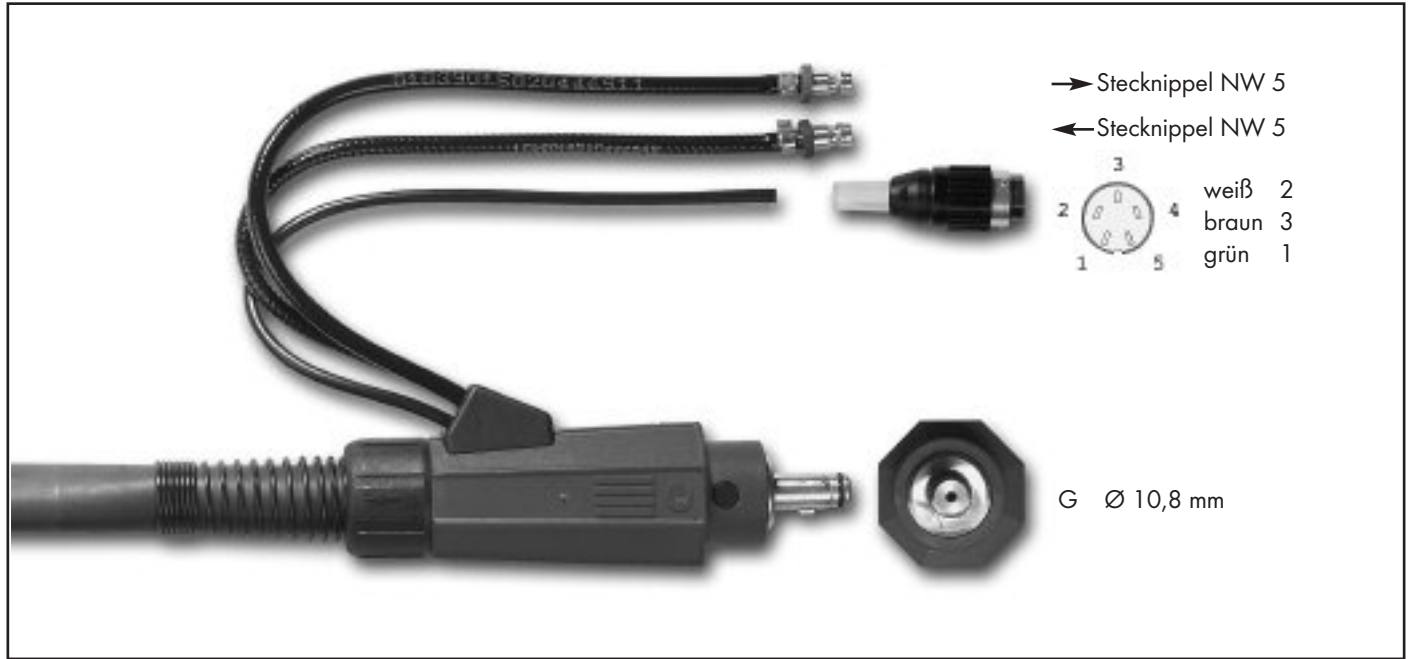

Brennertyp	Länge	Schalterfunktion	maschinenseitiger Anschluss	Schlauchpaketausführung	Bestellnummer
ABITIG® 18	4 m	DD	TCG Tuchel 5-pol.	Standard	7S4SK043523701A12
	8 m	DD	TCG Tuchel 5-pol.	Standard	7S4SK083523701A12
	4 m	DD	TCG Tuchel 5-pol.	High Flex Leder	7S4SH043523701A12
	8 m	DD	TCG Tuchel 5-pol.	High Flex Leder	7S4SH083523701A12
ABITIG® 18F	4 m	DD	TCG Tuchel 5-pol.	Standard	7S4FK043523701A12
	8 m	DD	TCG Tuchel 5-pol.	Standard	7S4FK083523701A12
	4 m	DD	TCG Tuchel 5-pol.	High Flex Leder	7S4FH043523701A12
	8 m	DD	TCG Tuchel 5-pol.	High Flex Leder	7S4FH083523701A12
ABITIG® 20	4 m	DD	TCG Tuchel 5-pol.	Standard	7S5SK043523701A12
	8 m	DD	TCG Tuchel 5-pol.	Standard	7S5SK083523701A12
	4 m	DD	TCG Tuchel 5-pol.	High Flex Leder	7S5SH043523701A12
	8 m	DD	TCG Tuchel 5-pol.	High Flex Leder	7S5SH083523701A12
ABITIG® 20 Little	4 m	DD	TCG Tuchel 5-pol.	High Flex Leder	7L5SH043523701A12
	8 m	DD	TCG Tuchel 5-pol.	High Flex Leder	7L5SH083523701A12
ABITIG® 20F	4 m	DD	TCG Tuchel 5-pol.	Standard	7S5FK043523701A12
	8 m	DD	TCG Tuchel 5-pol.	Standard	7S5FK083523701A12
	4 m	DD	TCG Tuchel 5-pol.	High Flex Leder	7S5FH043523701A12
	8 m	DD	TCG Tuchel 5-pol.	High Flex Leder	7S5FH083523701A12
ABITIG® 20F Little	4 m	DD	TCG Tuchel 5-pol.	High Flex Leder	7L5FH043523701A12
	8 m	DD	TCG Tuchel 5-pol.	High Flex Leder	7L5FH083523701A12

Technische Änderungen vorbehalten • Verkaufspreise = unverbindliche Preisempfehlung - Angebot freibleibend • © Copyright

ABITIG® GRIP / ABITIG® GRIP Little-Brennerpreisliste

passend für WIG-Stromquellen des Fabrikates „merkle“

Brennertyp	Länge	Schalterfunktion	maschinenseitiger Anschluss	Schlauchpaketausführung	Bestellnummer
ABITIG® 12-1	4 m	DD	TCG Tuchel 5-pol.	Standard	7S6SK043523701A12
	8 m	DD	TCG Tuchel 5-pol.	Standard	7S6SK083523701A12
	4 m	DD	TCG Tuchel 5-pol.	High Flex Leder	7S6SH043523701A12
	8 m	DD	TCG Tuchel 5-pol.	High Flex Leder	7S6SH083523701A12
ABITIG® 18SC	4 m	DD	TCG Tuchel 5-pol.	Standard	7S7SK043523701A12
	8 m	DD	TCG Tuchel 5-pol.	Standard	7S7SK083523701A12
	4 m	DD	TCG Tuchel 5-pol.	High Flex Leder	7S7SH043523701A12
	8 m	DD	TCG Tuchel 5-pol.	High Flex Leder	7S7SH083523701A12
ABITIG® 24W	4 m	DD	TCG Tuchel 5-pol.	Standard	7S9SK043523701A12
	8 m	DD	TCG Tuchel 5-pol.	Standard	7S9SK083523701A12
	4 m	DD	TCG Tuchel 5-pol.	High Flex Leder	7S9SH043523701A12
	8 m	DD	TCG Tuchel 5-pol.	High Flex Leder	7S9SH083523701A12
ABITIG® 24W Little	4 m	DD	TCG Tuchel 5-pol.	High Flex Leder	7L9SH043523701A12
	8 m	DD	TCG Tuchel 5-pol.	High Flex Leder	7L9SH083523701A12
ABITIG® 450W	4 m	DD	TCG Tuchel 5-pol.	Standard	7T5SK043523701A12
	8 m	DD	TCG Tuchel 5-pol.	Standard	7T5SK083523701A12
	4 m	DD	TCG Tuchel 5-pol.	High Flex Leder	7T5SH043523701A12
	8 m	DD	TCG Tuchel 5-pol.	High Flex Leder	7T5SH083523701A12
ABITIG® 260W	4 m	DD	TCG Tuchel 5-pol.	Standard	7T7SK043523701A12
	8 m	DD	TCG Tuchel 5-pol.	Standard	7T7SK083523701A12
	4 m	DD	TCG Tuchel 5-pol.	High Flex Leder	7T7SH043523701A12
	8 m	DD	TCG Tuchel 5-pol.	High Flex Leder	7T7SH083523701A12
ABITIG® 260W Little	4 m	DD	TCG Tuchel 5-pol.	High Flex Leder	7L7SH043523701A12
	8 m	DD	TCG Tuchel 5-pol.	High Flex Leder	7L7SH083523701A12
ABITIG® 450W SC	4 m	DD	TCG Tuchel 5-pol.	Standard	
	8 m	DD	TCG Tuchel 5-pol.	Standard	
	4 m	DD	TCG Tuchel 5-pol.	High Flex Leder	7T8SH043523701A12
	8 m	DD	TCG Tuchel 5-pol.	High Flex Leder	7T8SH083523701A12

ABITIG® GRIP / ABITIG® GRIP Little-Brennerpreisliste

passend für WIG-Stromquellen des Fabrikates „merkle“

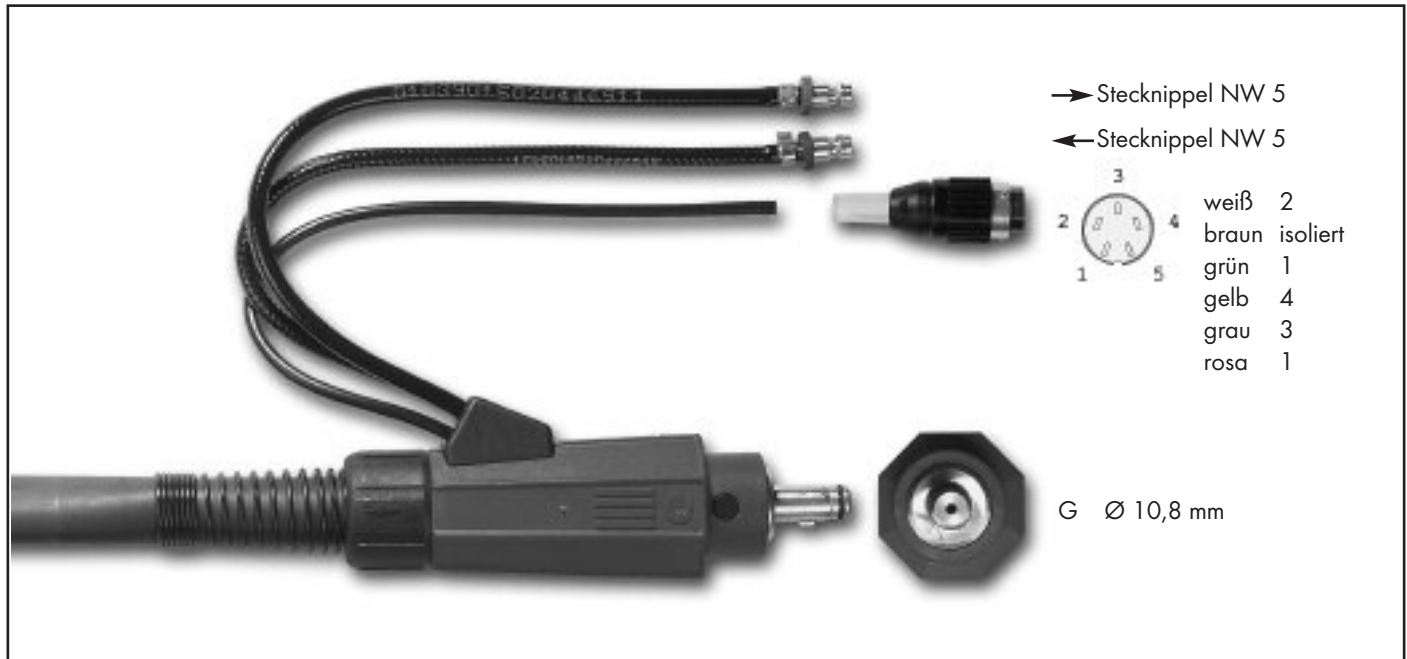

Brennertyp	Länge	Schalterfunktion	maschinenseitiger Anschluss	Schlauchpaketausführung	Bestellnummer
ABITIG® 18	4 m	EDP	TCG Tuchel 5-pol.	Standard	7S4SK046543730A12
	8 m	EDP	TCG Tuchel 5-pol.	Standard	7S4SK086543730A12
	4 m	EDP	TCG Tuchel 5-pol.	High Flex Leder	7S4SH046543730A12
	8 m	EDP	TCG Tuchel 5-pol.	High Flex Leder	7S4SH086543730A12
ABITIG® 18F	4 m	EDP	TCG Tuchel 5-pol.	Standard	7S4FK046543730A12
	8 m	EDP	TCG Tuchel 5-pol.	Standard	7S4FK086543730A12
	4 m	EDP	TCG Tuchel 5-pol.	High Flex Leder	7S4FH046543730A12
	8 m	EDP	TCG Tuchel 5-pol.	High Flex Leder	7S4FH086543730A12
ABITIG® 20	4 m	EDP	TCG Tuchel 5-pol.	Standard	7S5SK046543730A12
	8 m	EDP	TCG Tuchel 5-pol.	Standard	7S5SK086543730A12
	4 m	EDP	TCG Tuchel 5-pol.	High Flex Leder	7S5SH046543730A12
	8 m	EDP	TCG Tuchel 5-pol.	High Flex Leder	7S5SH086543730A12
ABITIG® 20F	4 m	EDP	TCG Tuchel 5-pol.	Standard	7S5FK046543730A12
	8 m	EDP	TCG Tuchel 5-pol.	Standard	7S5FK086543730A12
	4 m	EDP	TCG Tuchel 5-pol.	High Flex Leder	7S5FH046543730A12
	8 m	EDP	TCG Tuchel 5-pol.	High Flex Leder	7S5FH086543730A12

Technische Änderungen vorbehalten • Verkaufspreise = unverbindliche Preisempfehlung - Angebot freibleibend • © Copyright

ABITIG® GRIP / ABITIG® GRIP Little-Brennerpreisliste

passend für WIG-Stromquellen des Fabrikates „merkle“

Brennertyp	Länge	Schalterfunktion	maschinenseitiger Anschluss	Schlauchpaketausführung	Bestellnummer
ABITIG® 12-1	4 m	EDP	TCG Tuchel 5-pol.	Standard	7S6SK046543730A12
	8 m	EDP	TCG Tuchel 5-pol.	Standard	7S6SK086543730A12
	4 m	EDP	TCG Tuchel 5-pol.	High Flex Leder	7S6SH046543730A12
	8 m	EDP	TCG Tuchel 5-pol.	High Flex Leder	7S6SH086543730A12
ABITIG® 18SC	4 m	EDP	TCG Tuchel 5-pol.	Standard	7S7SK046543730A12
	8 m	EDP	TCG Tuchel 5-pol.	Standard	7S7SK086543730A12
	4 m	EDP	TCG Tuchel 5-pol.	High Flex Leder	7S7SH046543730A12
	8 m	EDP	TCG Tuchel 5-pol.	High Flex Leder	7S7SH086543730A12
ABITIG® 24W	4 m	EDP	TCG Tuchel 5-pol.	Standard	7S9SK046543730A12
	8 m	EDP	TCG Tuchel 5-pol.	Standard	7S9SK086543730A12
	4 m	EDP	TCG Tuchel 5-pol.	High Flex Leder	7S9SH046543730A12
	8 m	EDP	TCG Tuchel 5-pol.	High Flex Leder	7S9SH086543730A12
ABITIG® 450W	4 m	EDP	TCG Tuchel 5-pol.	Standard	7T5SK046543730A12
	8 m	EDP	TCG Tuchel 5-pol.	Standard	7T5SK086543730A12
	4 m	EDP	TCG Tuchel 5-pol.	High Flex Leder	7T5SH046543730A12
	8 m	EDP	TCG Tuchel 5-pol.	High Flex Leder	7T5SH086543730A12
ABITIG® 260W	4 m	EDP	TCG Tuchel 5-pol.	Standard	7T7SK046543730A12
	8 m	EDP	TCG Tuchel 5-pol.	Standard	7T7SK086543730A12
	4 m	EDP	TCG Tuchel 5-pol.	High Flex Leder	7T7SH046543730A12
	8 m	EDP	TCG Tuchel 5-pol.	High Flex Leder	7T7SH086543730A12
ABITIG® 450W SC	4 m	EDP	TCG Tuchel 5-pol.	Standard	
	8 m	EDP	TCG Tuchel 5-pol.	Standard	
	4 m	EDP	TCG Tuchel 5-pol.	High Flex Leder	7T8SH046543730A12
	8 m	EDP	TCG Tuchel 5-pol.	High Flex Leder	7T8SH086543730A12

ABITIG® GRIP / ABITIG® GRIP Little-Brennerpreisliste

passend für WIG-Stromquellen des Fabrikates „messer-lincoln“

Für dieses Gerätefabrikat ist in der Bestellnummer und somit auch im Lieferumfang das Ansteuermodul BIS-10 enthalten. Das Ansteuermodul BIS-10 enthält im Gegensatz zu BIS-02 die verstärkte Schalterausführung (2x) wegen der geräteabhängigen höheren Schaltströme.

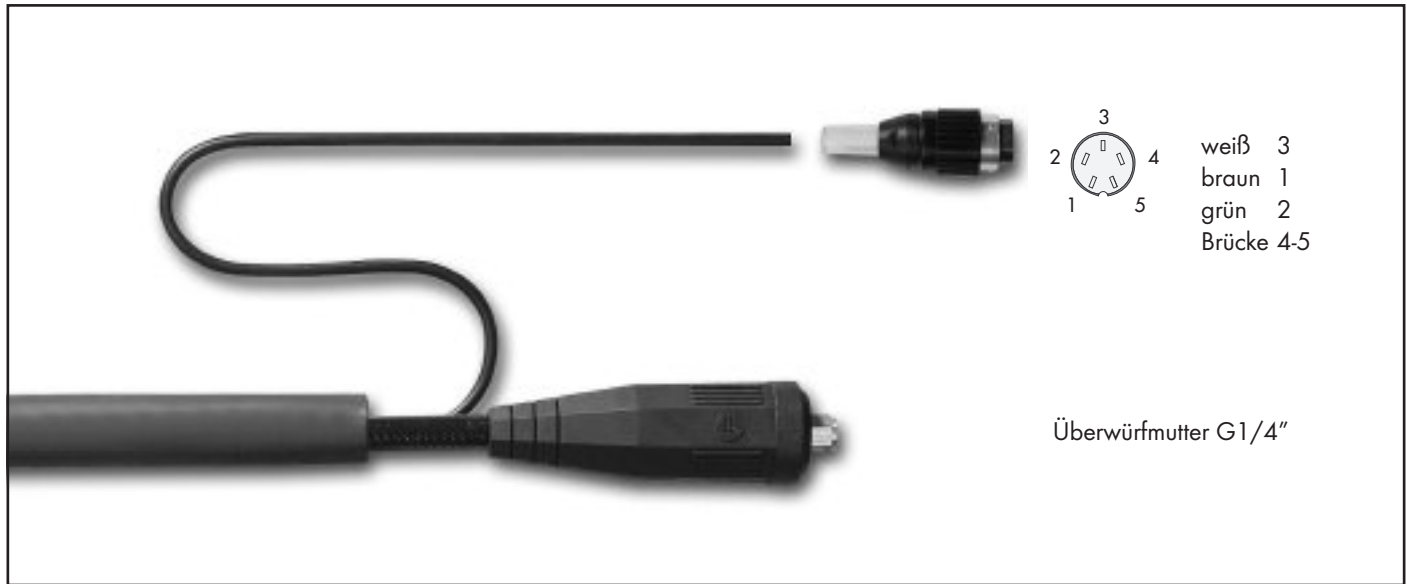

Brennertyp	Länge	Schalterfunktion	maschinenseitiger Anschluss	Schlauchpaketausführung	Bestellnummer
ABITIG® 9	4 m	DD	EA Tuchel 5-pol.	Standard	7S1SK043601102D00
	8 m	DD	EA Tuchel 5-pol.	Standard	7S1SK083601102D00
	4 m	DD	EA Tuchel 5-pol.	High Flex Leder	7S1SH043601102D00
	8 m	DD	EA Tuchel 5-pol.	High Flex Leder	7S1SH083601102D00
ABITIG® 9F	4 m	DD	EA Tuchel 5-pol.	Standard	7S1FK043601102D00
	8 m	DD	EA Tuchel 5-pol.	Standard	7S1FK083601102D00
	4 m	DD	EA Tuchel 5-pol.	High Flex Leder	7S1FH043601102D00
	8 m	DD	EA Tuchel 5-pol.	High Flex Leder	7S1FH083601102D00
ABITIG® 17	4 m	DD	EA Tuchel 5-pol.	Standard	7S2SK043601102D00
	8 m	DD	EA Tuchel 5-pol.	Standard	7S2SK083601102D00
	4 m	DD	EA Tuchel 5-pol.	High Flex Leder	7S2SH043601102D00
	8 m	DD	EA Tuchel 5-pol.	High Flex Leder	7S2SH083601102D00
ABITIG® 17F	4 m	DD	EA Tuchel 5-pol.	Standard	7S2FK043601102D00
	8 m	DD	EA Tuchel 5-pol.	Standard	7S2FK083601102D00
	4 m	DD	EA Tuchel 5-pol.	High Flex Leder	7S2FH043601102D00
	8 m	DD	EA Tuchel 5-pol.	High Flex Leder	7S2FH083601102D00

Technische Änderungen vorbehalten • Verkaufspreise = unverbindliche Preisempfehlung - Angebot freibleibend • © Copyright

ABITIG® GRIP / ABITIG® GRIP Little-Brennerpreisliste

passend für WIG-Stromquellen des Fabrikates „messer-lincoln“

Für dieses Gerätefabrikat ist in der Bestellnummer und somit auch im Lieferumfang das Ansteuermodul BIS-10 enthalten. Das Ansteuermodul BIS-10 enthält im Gegensatz zu BIS-02 die verstärkte Schalterausführung (2x) wegen der geräteabhängigen höheren Schaltströme.



Brennertyp	Länge	Schalterfunktion	maschinenseitiger Anschluss	Schlauchpaketausführung	Bestellnummer
ABITIG® 9					
ABITIG® 9F					
ABITIG® 17					
ABITIG® 17F					

ABITIG® GRIP / ABITIG® GRIP Little-Brennerpreisliste

passend für WIG-Stromquellen des Fabrikates „messer-lincoln“

Brennertyp	Länge	Schalterfunktion	maschinenseitiger Anschluss	Schlauchpaketausführung	Bestellnummer
ABITIG® 26	4 m	DD	BSB 35-50 Tuchel 5-pol.	Standard	7S3SK043600002D01
	8 m	DD	BSB 35-50 Tuchel 5-pol.	Standard	7S3SK083600002D01
	4 m	DD	BSB 35-50 Tuchel 5-pol.	High Flex Leder	7S3SH043600002D01
	8 m	DD	BSB 35-50 Tuchel 5-pol.	High Flex Leder	7S3SH083600002D01
ABITIG® 26F	4 m	DD	BSB 35-50 Tuchel 5-pol.	Standard	7S3FK043600002D01
	8 m	DD	BSB 35-50 Tuchel 5-pol.	Standard	7S3FK083600002D01
	4 m	DD	BSB 35-50 Tuchel 5-pol.	High Flex Leder	7S3FH043600002D01
	8 m	DD	BSB 35-50 Tuchel 5-pol.	High Flex Leder	7S3FH083600002D01
ABITIG® 24G	4 m	DD	BSB 35-50 Tuchel 5-pol.	Standard	7S8SK043600002D01
	8 m	DD	BSB 35-50 Tuchel 5-pol.	Standard	7S8SK083600002D01
	4 m	DD	BSB 35-50 Tuchel 5-pol.	High Flex Leder	7S8SH043600002D01
	8 m	DD	BSB 35-50 Tuchel 5-pol.	High Flex Leder	7S8SH083600002D01
ABITIG® 200	4 m	DD	BSB 35-50 Tuchel 5-pol.	Standard	7T4SK043600002D01
	8 m	DD	BSB 35-50 Tuchel 5-pol.	Standard	7T4SK083600002D01
	4 m	DD	BSB 35-50 Tuchel 5-pol.	High Flex Leder	7T4SH043600002D01
	8 m	DD	BSB 35-50 Tuchel 5-pol.	High Flex Leder	7T4SH083600002D01
ABITIG® 200F	4 m	DD	BSB 35-50 Tuchel 5-pol.	Standard	7T4FK043600002D01
	8 m	DD	BSB 35-50 Tuchel 5-pol.	Standard	7T4FK083600002D01
	4 m	DD	BSB 35-50 Tuchel 5-pol.	High Flex Leder	7T4FH043600002D01
	8 m	DD	BSB 35-50 Tuchel 5-pol.	High Flex Leder	7T4FH083600002D01
ABITIG® 150	4 m	DD	BSB 35-50 Tuchel 5-pol.	Standard	7T6SK043600002D01
	8 m	DD	BSB 35-50 Tuchel 5-pol.	Standard	7T6SK083600002D01
	4 m	DD	BSB 35-50 Tuchel 5-pol.	High Flex Leder	7T6SH043600002D01
	8 m	DD	BSB 35-50 Tuchel 5-pol.	High Flex Leder	7T6SH083600002D01
ABITIG® 150F	4 m	DD	BSB 35-50 Tuchel 5-pol.	Standard	7T6FK043600002D01
	8 m	DD	BSB 35-50 Tuchel 5-pol.	Standard	7T6FK083600002D01
	4 m	DD	BSB 35-50 Tuchel 5-pol.	High Flex Leder	7T6FH043600002D01
	8 m	DD	BSB 35-50 Tuchel 5-pol.	High Flex Leder	7T6FH083600002D01

ABITIG® GRIP / ABITIG® GRIP Little-Brennerpreisliste

passend für WIG-Stromquellen des Fabrikates „messer-lincoln“

Für dieses Gerätefabrikat ist in der Bestellnummer und somit auch im Lieferumfang das Ansteuermodul BIS-10 enthalten. Das Ansteuermodul BIS-10 enthält im Gegensatz zu BIS-02 die verstärkte Schalterausführung (2x) wegen der geräteabhängigen höheren Schaltströme.



Brennertyp	Länge	Schalterfunktion	maschinenseitiger Anschluss	Schlauchpaketausführung	Bestellnummer
ABITIG® 18	4 m	DD	EA Tuchel 5-pol.	Standard	7S4SK043600801D15
	8 m	DD	EA Tuchel 5-pol.	Standard	7S4SK083600801D15
	4 m	DD	EA Tuchel 5-pol.	High Flex Leder	7S4SH043600801D15
	8 m	DD	EA Tuchel 5-pol.	High Flex Leder	7S4SH083600801D15
ABITIG® 18F	4 m	DD	EA Tuchel 5-pol.	Standard	7S4FK043600801D15
	8 m	DD	EA Tuchel 5-pol.	Standard	7S4FK083600801D15
	4 m	DD	EA Tuchel 5-pol.	High Flex Leder	7S4FH043600801D15
	8 m	DD	EA Tuchel 5-pol.	High Flex Leder	7S4FH083600801D15
ABITIG® 20	4 m	DD	EA Tuchel 5-pol.	Standard	7S5SK043600801D15
	8 m	DD	EA Tuchel 5-pol.	Standard	7S5SK083600801D15
	4 m	DD	EA Tuchel 5-pol.	High Flex Leder	7S5SH043600801D15
	8 m	DD	EA Tuchel 5-pol.	High Flex Leder	7S5SH083600801D15
ABITIG® 20F	4 m	DD	EA Tuchel 5-pol.	Standard	7S5FK043600801D15
	8 m	DD	EA Tuchel 5-pol.	Standard	7S5FK083600801D15
	4 m	DD	EA Tuchel 5-pol.	High Flex Leder	7S5FH043600801D15
	8 m	DD	EA Tuchel 5-pol.	High Flex Leder	7S5FH083600801D15

Technische Änderungen vorbehalten • Verkaufspreise = unverbindliche Preisempfehlung - Angebot freibleibend • © Copyright

ABITIG® GRIP / ABITIG® GRIP Little-Brennerpreisliste

passend für WIG-Stromquellen des Fabrikates „messer-lincoln“

Brennertyp	Länge	Schalterfunktion	maschinenseitiger Anschluss	Schlauchpaketausführung	Bestellnummer
ABITIG® 12-1	4 m	DD	EA Tuchel 5-pol.	Standard	7S6SK043600801D15
	8 m	DD	EA Tuchel 5-pol.	Standard	7S6SK083600801D15
	4 m	DD	EA Tuchel 5-pol.	High Flex Leder	7S6SH043600801D15
	8 m	DD	EA Tuchel 5-pol.	High Flex Leder	7S6SH083600801D15
ABITIG® 18SC	4 m	DD	EA Tuchel 5-pol.	Standard	7S7SK043600801D15
	8 m	DD	EA Tuchel 5-pol.	Standard	7S7SK083600801D15
	4 m	DD	EA Tuchel 5-pol.	High Flex Leder	7S7SH043600801D15
	8 m	DD	EA Tuchel 5-pol.	High Flex Leder	7S7SH083600801D15
ABITIG® 24W	4 m	DD	EA Tuchel 5-pol.	Standard	7S9SK043600801D15
	8 m	DD	EA Tuchel 5-pol.	Standard	7S9SK083600801D15
	4 m	DD	EA Tuchel 5-pol.	High Flex Leder	7S9SH043600801D15
	8 m	DD	EA Tuchel 5-pol.	High Flex Leder	7S9SH083600801D15
ABITIG® 450W	4 m	DD	EA Tuchel 5-pol.	Standard	7T5SK043600801D15
	8 m	DD	EA Tuchel 5-pol.	Standard	7T5SK083600801D15
	4 m	DD	EA Tuchel 5-pol.	High Flex Leder	7T5SH043600801D15
	8 m	DD	EA Tuchel 5-pol.	High Flex Leder	7T5SH083600801D15
ABITIG® 260W	4 m	DD	EA Tuchel 5-pol.	Standard	7T7SK043600801D15
	8 m	DD	EA Tuchel 5-pol.	Standard	7T7SK083600801D15
	4 m	DD	EA Tuchel 5-pol.	High Flex Leder	7T7SH043600801D15
	8 m	DD	EA Tuchel 5-pol.	High Flex Leder	7T7SH083600801D15
ABITIG® 450W SC	4 m	DD	EA Tuchel 5-pol.	Standard	
	8 m	DD	EA Tuchel 5-pol.	Standard	
	4 m	DD	EA Tuchel 5-pol.	High Flex Leder	7T8SH043600801D15
	8 m	DD	EA Tuchel 5-pol.	High Flex Leder	7T8SH083600801D15

ABITIG® GRIP / ABITIG® GRIP Little-Brennerpreisliste

passend für WIG-Stromquellen des Fabrikates „migatronic“



Brennertyp	Länge	Schalterfunktion	maschinenseitiger Anschluss	Schlauchpaketausführung	Bestellnummer
ABITIG® 9	4 m	EDP	BSB 35-50 Rundsteckverbinder 7-pol.	Standard	7S1SK043590025B04
	8 m	EDP	BSB 35-50 Rundsteckverbinder 7-pol.	Standard	7S1SK083590025B04
	4 m	EDP	BSB 35-50 Rundsteckverbinder 7-pol.	High Flex Leder	7S1SH043590025B04
	8 m	EDP	BSB 35-50 Rundsteckverbinder 7-pol.	High Flex Leder	7S1SH083590025B04
ABITIG® 9F	4 m	EDP	BSB 35-50 Rundsteckverbinder 7-pol.	Standard	7S1FK043590025B04
	8 m	EDP	BSB 35-50 Rundsteckverbinder 7-pol.	Standard	7S1FK083590025B04
	4 m	EDP	BSB 35-50 Rundsteckverbinder 7-pol.	High Flex Leder	7S1FH043590025B04
	8 m	EDP	BSB 35-50 Rundsteckverbinder 7-pol.	High Flex Leder	7S1FH083590025B04
ABITIG® 17	4 m	EDP	BSB 35-50 Rundsteckverbinder 7-pol.	Standard	7S2SK043590025B04
	8 m	EDP	BSB 35-50 Rundsteckverbinder 7-pol.	Standard	7S2SK083590025B04
	4 m	EDP	BSB 35-50 Rundsteckverbinder 7-pol.	High Flex Leder	7S2SH043590025B04
	8 m	EDP	BSB 35-50 Rundsteckverbinder 7-pol.	High Flex Leder	7S2SH083590025B04
ABITIG® 17F	4 m	EDP	BSB 35-50 Rundsteckverbinder 7-pol.	Standard	7S2FK043590025B04
	8 m	EDP	BSB 35-50 Rundsteckverbinder 7-pol.	Standard	7S2FK083590025B04
	4 m	EDP	BSB 35-50 Rundsteckverbinder 7-pol.	High Flex Leder	7S2FH043590025B04
	8 m	EDP	BSB 35-50 Rundsteckverbinder 7-pol.	High Flex Leder	7S2FH083590025B04

Technische Änderungen vorbehalten • Verkaufspreise = unverbindliche Preisempfehlung - Angebot freibleibend • © Copyright

ABITIG® GRIP / ABITIG® GRIP Little-Brennerpreisliste

passend für WIG-Stromquellen des Fabrikates „migatronic“

Brennertyp	Länge	Schalterfunktion	maschinenseitiger Anschluss	Schlauchpaketausführung	Bestellnummer
ABITIG® 26	4 m	EDP	BSB 35-50 Rundsteckverbinder 7-pol.	Standard	7S3SK043590025B04
	8 m	EDP	BSB 35-50 Rundsteckverbinder 7-pol.	Standard	7S3SK083590025B04
	4 m	EDP	BSB 35-50 Rundsteckverbinder 7-pol.	High Flex Leder	7S3SH043590025B04
	8 m	EDP	BSB 35-50 Rundsteckverbinder 7-pol.	High Flex Leder	7S3SH083590025B04
ABITIG® 26F	4 m	EDP	BSB 35-50 Rundsteckverbinder 7-pol.	Standard	7S3FK043590025B04
	8 m	EDP	BSB 35-50 Rundsteckverbinder 7-pol.	Standard	7S3FK083590025B04
	4 m	EDP	BSB 35-50 Rundsteckverbinder 7-pol.	High Flex Leder	7S3FH043590025B04
	8 m	EDP	BSB 35-50 Rundsteckverbinder 7-pol.	High Flex Leder	7S3FH083590025B04
ABITIG® 24G	4 m	EDP	BSB 35-50 Rundsteckverbinder 7-pol.	Standard	7S8SK043590025B04
	8 m	EDP	BSB 35-50 Rundsteckverbinder 7-pol.	Standard	7S8SK083590025B04
	4 m	EDP	BSB 35-50 Rundsteckverbinder 7-pol.	High Flex Leder	7S8SH043590025B04
	8 m	EDP	BSB 35-50 Rundsteckverbinder 7-pol.	High Flex Leder	7S8SH083590025B04
ABITIG® 200	4 m	EDP	BSB 35-50 Rundsteckverbinder 7-pol.	Standard	7T4SK043590025B04
	8 m	EDP	BSB 35-50 Rundsteckverbinder 7-pol.	Standard	7T4SK083590025B04
	4 m	EDP	BSB 35-50 Rundsteckverbinder 7-pol.	High Flex Leder	7T4SH043590025B04
	8 m	EDP	BSB 35-50 Rundsteckverbinder 7-pol.	High Flex Leder	7T4SH083590025B04
ABITIG® 200F	4 m	EDP	BSB 35-50 Rundsteckverbinder 7-pol.	Standard	7T4FK043590025B04
	8 m	EDP	BSB 35-50 Rundsteckverbinder 7-pol.	Standard	7T4FK083590025B04
	4 m	EDP	BSB 35-50 Rundsteckverbinder 7-pol.	High Flex Leder	7T4FH043590025B04
	8 m	EDP	BSB 35-50 Rundsteckverbinder 7-pol.	High Flex Leder	7T4FH083590025B04
ABITIG® 150	4 m	EDP	BSB 35-50 Rundsteckverbinder 7-pol.	Standard	7T6SK043590025B04
	8 m	EDP	BSB 35-50 Rundsteckverbinder 7-pol.	Standard	7T6SK083590025B04
	4 m	EDP	BSB 35-50 Rundsteckverbinder 7-pol.	High Flex Leder	7T6SH043590025B04
	8 m	EDP	BSB 35-50 Rundsteckverbinder 7-pol.	High Flex Leder	7T6SH083590025B04
ABITIG® 150F	4 m	EDP	BSB 35-50 Rundsteckverbinder 7-pol.	Standard	7T6FK043590025B04
	8 m	EDP	BSB 35-50 Rundsteckverbinder 7-pol.	Standard	7T6FK083590025B04
	4 m	EDP	BSB 35-50 Rundsteckverbinder 7-pol.	High Flex Leder	7T6FH043590025B04
	8 m	EDP	BSB 35-50 Rundsteckverbinder 7-pol.	High Flex Leder	7T6FH083590025B04

ABITIG® GRIP / ABITIG® GRIP Little-Brennerpreisliste

passend für WIG-Stromquellen des Fabrikates „migatronic“

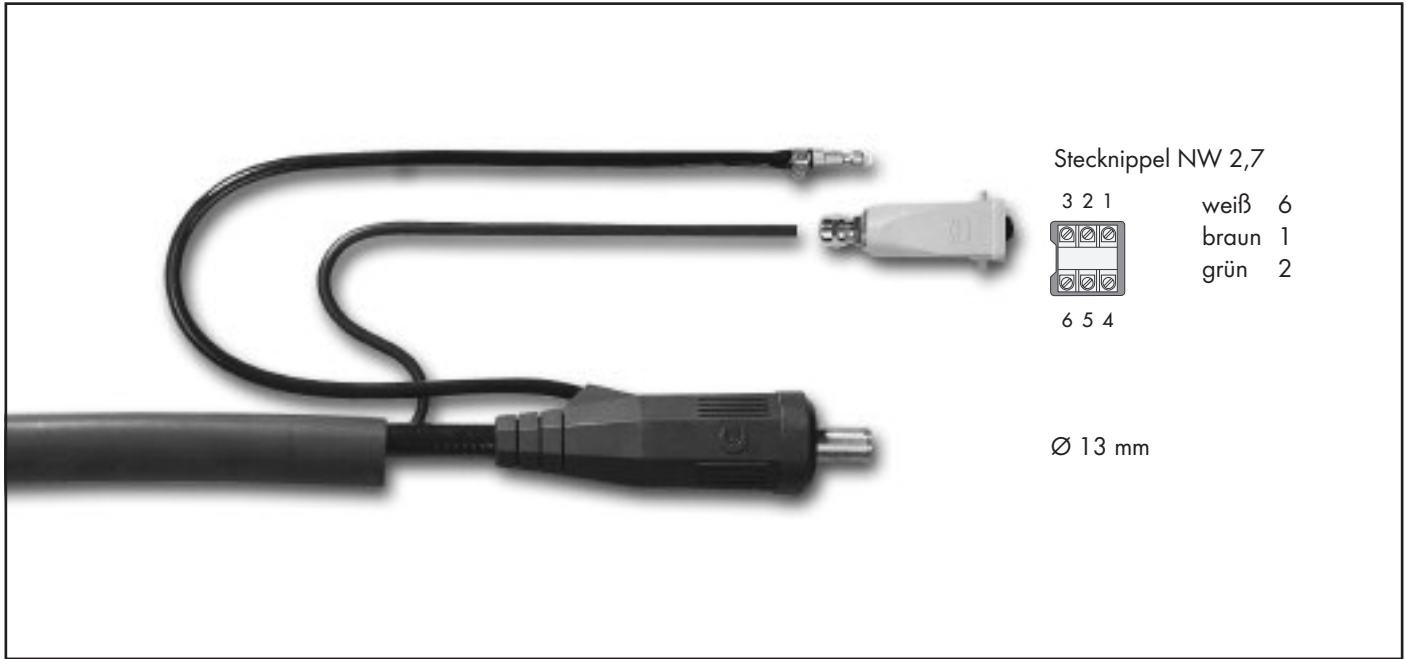

Brennertyp	Länge	Schalterfunktion	maschinenseitiger Anschluss	Schlauchpaketausführung	Bestellnummer
ABITIG® 9	4 m	EDP	BSB 35-50 Harting 6-pol.	Standard	7S1SK043590011B04
	8 m	EDP	BSB 35-50 Harting 6-pol.	Standard	7S1SK083590011B04
	4 m	EDP	BSB 35-50 Harting 6-pol.	High Flex Leder	7S1SH043590011B04
	8 m	EDP	BSB 35-50 Harting 6-pol.	High Flex Leder	7S1SH083590011B04
ABITIG® 9F	4 m	EDP	BSB 35-50 Harting 6-pol.	Standard	7S1FK043590011B04
	8 m	EDP	BSB 35-50 Harting 6-pol.	Standard	7S1FK083590011B04
	4 m	EDP	BSB 35-50 Harting 6-pol.	High Flex Leder	7S1FH043590011B04
	8 m	EDP	BSB 35-50 Harting 6-pol.	High Flex Leder	7S1FH083590011B04
ABITIG® 17	4 m	EDP	BSB 35-50 Harting 6-pol.	Standard	7S2SK043590011B04
	8 m	EDP	BSB 35-50 Harting 6-pol.	Standard	7S2SK083590011B04
	4 m	EDP	BSB 35-50 Harting 6-pol.	High Flex Leder	7S2SH043590011B04
	8 m	EDP	BSB 35-50 Harting 6-pol.	High Flex Leder	7S2SH083590011B04
ABITIG® 17F	4 m	EDP	BSB 35-50 Harting 6-pol.	Standard	7S2FK043590011B04
	8 m	EDP	BSB 35-50 Harting 6-pol.	Standard	7S2FK083590011B04
	4 m	EDP	BSB 35-50 Harting 6-pol.	High Flex Leder	7S2FH043590011B04
	8 m	EDP	BSB 35-50 Harting 6-pol.	High Flex Leder	7S2FH083590011B04

Technische Änderungen vorbehalten • Verkaufspreise = unverbindliche Preisempfehlung - Angebot freibleibend • © Copyright

ABITIG® GRIP / ABITIG® GRIP Little-Brennerpreisliste

passend für WIG-Stromquellen des Fabrikates „migatronic“

Brennertyp	Länge	Schalterfunktion	maschinenseitiger Anschluss	Schlauchpaketausführung	Bestellnummer
ABITIG® 26	4 m	EDP	BSB 35-50 Harting 6-pol.	Standard	7S3SK043590011B04
	8 m	EDP	BSB 35-50 Harting 6-pol.	Standard	7S3SK083590011B04
	4 m	EDP	BSB 35-50 Harting 6-pol.	High Flex Leder	7S3SH043590011B04
	8 m	EDP	BSB 35-50 Harting 6-pol.	High Flex Leder	7S3SH083590011B04
ABITIG® 26F	4 m	EDP	BSB 35-50 Harting 6-pol.	Standard	7S3FK043590011B04
	8 m	EDP	BSB 35-50 Harting 6-pol.	Standard	7S3FK083590011B04
	4 m	EDP	BSB 35-50 Harting 6-pol.	High Flex Leder	7S3FH043590011B04
	8 m	EDP	BSB 35-50 Harting 6-pol.	High Flex Leder	7S3FH083590011B04
ABITIG® 24G	4 m	EDP	BSB 35-50 Harting 6-pol.	Standard	7S8SK043590011B04
	8 m	EDP	BSB 35-50 Harting 6-pol.	Standard	7S8SK083590011B04
	4 m	EDP	BSB 35-50 Harting 6-pol.	High Flex Leder	7S8SH043590011B04
	8 m	EDP	BSB 35-50 Harting 6-pol.	High Flex Leder	7S8SH083590011B04
ABITIG® 200	4 m	EDP	BSB 35-50 Harting 6-pol.	Standard	7T4SK043590011B04
	8 m	EDP	BSB 35-50 Harting 6-pol.	Standard	7T4SK083590011B04
	4 m	EDP	BSB 35-50 Harting 6-pol.	High Flex Leder	7T4SH043590011B04
	8 m	EDP	BSB 35-50 Harting 6-pol.	High Flex Leder	7T4SH083590011B04
ABITIG® 200F	4 m	EDP	BSB 35-50 Harting 6-pol.	Standard	7T4FK043590011B04
	8 m	EDP	BSB 35-50 Harting 6-pol.	Standard	7T4FK083590011B04
	4 m	EDP	BSB 35-50 Harting 6-pol.	High Flex Leder	7T4FH043590011B04
	8 m	EDP	BSB 35-50 Harting 6-pol.	High Flex Leder	7T4FH083590011B04
ABITIG® 150	4 m	EDP	BSB 35-50 Harting 6-pol.	Standard	7T6SK043590011B04
	8 m	EDP	BSB 35-50 Harting 6-pol.	Standard	7T6SK083590011B04
	4 m	EDP	BSB 35-50 Harting 6-pol.	High Flex Leder	7T6SH043590011B04
	8 m	EDP	BSB 35-50 Harting 6-pol.	High Flex Leder	7T6SH083590011B04
ABITIG® 150F	4 m	EDP	BSB 35-50 Harting 6-pol.	Standard	7T6FK043590011B04
	8 m	EDP	BSB 35-50 Harting 6-pol.	Standard	7T6FK083590011B04
	4 m	EDP	BSB 35-50 Harting 6-pol.	High Flex Leder	7T6FH043590011B04
	8 m	EDP	BSB 35-50 Harting 6-pol.	High Flex Leder	7T6FH083590011B04

ABITIG® GRIP / ABITIG® GRIP Little-Brennerpreisliste

passend für WIG-Stromquellen des Fabrikates „migatronic“



Brennertyp	Länge	Schalterfunktion	maschinenseitiger Anschluss	Schlauchpaketausführung	Bestellnummer
ABITIG® 9	4 m	ED	BSB 35-50 Rundsteckverbinder 7-pol.	Standard	7S1SK043510025A04
	8 m	ED	BSB 35-50 Rundsteckverbinder 7-pol.	Standard	7S1SK083510025A04
	4 m	ED	BSB 35-50 Rundsteckverbinder 7-pol.	High Flex Leder	7S1SH043510025A04
	8 m	ED	BSB 35-50 Rundsteckverbinder 7-pol.	High Flex Leder	7S1SH083510025A04
ABITIG® 9 Little	4 m	ED	BSB 35-50 Rundsteckverbinder 7-pol.	High Flex Leder	7L1SH043510025A04
	8 m	ED	BSB 35-50 Rundsteckverbinder 7-pol.	High Flex Leder	7L1SH083510025A04
ABITIG® 9F	4 m	ED	BSB 35-50 Rundsteckverbinder 7-pol.	Standard	7S1FK043510025A04
	8 m	ED	BSB 35-50 Rundsteckverbinder 7-pol.	Standard	7S1FK083510025A04
	4 m	ED	BSB 35-50 Rundsteckverbinder 7-pol.	High Flex Leder	7S1FH043510025A04
	8 m	ED	BSB 35-50 Rundsteckverbinder 7-pol.	High Flex Leder	7S1FH083510025A04
ABITIG® 9F Little	4 m	ED	BSB 35-50 Rundsteckverbinder 7-pol.	High Flex Leder	7L1FH043510025A04
	8 m	ED	BSB 35-50 Rundsteckverbinder 7-pol.	High Flex Leder	7L1FH083510025A04
ABITIG® 17	4 m	ED	BSB 35-50 Rundsteckverbinder 7-pol.	Standard	7S2SK043510025A04
	8 m	ED	BSB 35-50 Rundsteckverbinder 7-pol.	Standard	7S2SK083510025A04
	4 m	ED	BSB 35-50 Rundsteckverbinder 7-pol.	High Flex Leder	7S2SH043510025A04
	8 m	ED	BSB 35-50 Rundsteckverbinder 7-pol.	High Flex Leder	7S2SH083510025A04
ABITIG® 17 Little	4 m	ED	BSB 35-50 Rundsteckverbinder 7-pol.	High Flex Leder	7L2SH043510025A04
	8 m	ED	BSB 35-50 Rundsteckverbinder 7-pol.	High Flex Leder	7L2SH083510025A04
ABITIG® 17F	4 m	ED	BSB 35-50 Rundsteckverbinder 7-pol.	Standard	7S2FK043510025A04
	8 m	ED	BSB 35-50 Rundsteckverbinder 7-pol.	Standard	7S2FK083510025A04
	4 m	ED	BSB 35-50 Rundsteckverbinder 7-pol.	High Flex Leder	7S2FH043510025A04
	8 m	ED	BSB 35-50 Rundsteckverbinder 7-pol.	High Flex Leder	7S2FH083510025A04
ABITIG® 17F Little	4 m	ED	BSB 35-50 Rundsteckverbinder 7-pol.	High Flex Leder	7L2FH043510025A04
	8 m	ED	BSB 35-50 Rundsteckverbinder 7-pol.	High Flex Leder	7L2FH083510025A04

Technische Änderungen vorbehalten • Verkaufspreise = unverbindliche Preisempfehlung - Angebot freibleibend • © Copyright

ABITIG® GRIP / ABITIG® GRIP Little-Brennerpreisliste

passend für WIG-Stromquellen des Fabrikates „migatronic“

Brennertyp	Länge	Schalterfunktion	maschinenseitiger Anschluss	Schlauchpaketausführung	Bestellnummer
ABITIG® 26	4 m	ED	BSB 35-50 Rundsteckverbinder 7-pol.	Standard	7S3SK043510025A04
	8 m	ED	BSB 35-50 Rundsteckverbinder 7-pol.	Standard	7S3SK083510025A04
	4 m	ED	BSB 35-50 Rundsteckverbinder 7-pol.	High Flex Leder	7S3SH043510025A04
	8 m	ED	BSB 35-50 Rundsteckverbinder 7-pol.	High Flex Leder	7S3SH083510025A04
ABITIG® 26F	4 m	ED	BSB 35-50 Rundsteckverbinder 7-pol.	Standard	7S3FK043510025A04
	8 m	ED	BSB 35-50 Rundsteckverbinder 7-pol.	Standard	7S3FK083510025A04
	4 m	ED	BSB 35-50 Rundsteckverbinder 7-pol.	High Flex Leder	7S3FH043510025A04
	8 m	ED	BSB 35-50 Rundsteckverbinder 7-pol.	High Flex Leder	7S3FH083510025A04
ABITIG® 24G	4 m	ED	BSB 35-50 Rundsteckverbinder 7-pol.	Standard	7S8SK043510025A04
	8 m	ED	BSB 35-50 Rundsteckverbinder 7-pol.	Standard	7S8SK083510025A04
	4 m	ED	BSB 35-50 Rundsteckverbinder 7-pol.	High Flex Leder	7S8SH043510025A04
	8 m	ED	BSB 35-50 Rundsteckverbinder 7-pol.	High Flex Leder	7S8SH083510025A04
ABITIG® 24G Little	4 m	ED	BSB 35-50 Rundsteckverbinder 7-pol.	High Flex Leder	7L8SH043510025A04
	8 m	ED	BSB 35-50 Rundsteckverbinder 7-pol.	High Flex Leder	7L8SH083510025A04
ABITIG® 200	4 m	ED	BSB 35-50 Rundsteckverbinder 7-pol.	Standard	7T4SK043510025A04
	8 m	ED	BSB 35-50 Rundsteckverbinder 7-pol.	Standard	7T4SK083510025A04
	4 m	ED	BSB 35-50 Rundsteckverbinder 7-pol.	High Flex Leder	7T4SH043510025A04
	8 m	ED	BSB 35-50 Rundsteckverbinder 7-pol.	High Flex Leder	7T4SH083510025A04
ABITIG® 200F	4 m	ED	BSB 35-50 Rundsteckverbinder 7-pol.	Standard	7T4FK043510025A04
	8 m	ED	BSB 35-50 Rundsteckverbinder 7-pol.	Standard	7T4FK083510025A04
	4 m	ED	BSB 35-50 Rundsteckverbinder 7-pol.	High Flex Leder	7T4FH043510025A04
	8 m	ED	BSB 35-50 Rundsteckverbinder 7-pol.	High Flex Leder	7T4FH083510025A04
ABITIG® 150	4 m	ED	BSB 35-50 Rundsteckverbinder 7-pol.	Standard	7T6SK043510025A04
	8 m	ED	BSB 35-50 Rundsteckverbinder 7-pol.	Standard	7T6SK083510025A04
	4 m	ED	BSB 35-50 Rundsteckverbinder 7-pol.	High Flex Leder	7T6SH043510025A04
	8 m	ED	BSB 35-50 Rundsteckverbinder 7-pol.	High Flex Leder	7T6SH083510025A04
ABITIG® 150 Little	4 m	ED	BSB 35-50 Rundsteckverbinder 7-pol.	High Flex Leder	7L6SH043510025A04
	8 m	ED	BSB 35-50 Rundsteckverbinder 7-pol.	High Flex Leder	7L6SH083510025A04
ABITIG® 150F	4 m	ED	BSB 35-50 Rundsteckverbinder 7-pol.	Standard	7T6FK043510025A04
	8 m	ED	BSB 35-50 Rundsteckverbinder 7-pol.	Standard	7T6FK083510025A04
	4 m	ED	BSB 35-50 Rundsteckverbinder 7-pol.	High Flex Leder	7T6FH043510025A04
	8 m	ED	BSB 35-50 Rundsteckverbinder 7-pol.	High Flex Leder	7T6FH083510025A04
ABITIG® 150F Little	4 m	ED	BSB 35-50 Rundsteckverbinder 7-pol.	High Flex Leder	7L6FH043510025A04
	8 m	ED	BSB 35-50 Rundsteckverbinder 7-pol.	High Flex Leder	7L6FH083510025A04

ABITIG® GRIP / ABITIG® GRIP Little-Brennerpreisliste

passend für WIG-Stromquellen des Fabrikates „migatronic“

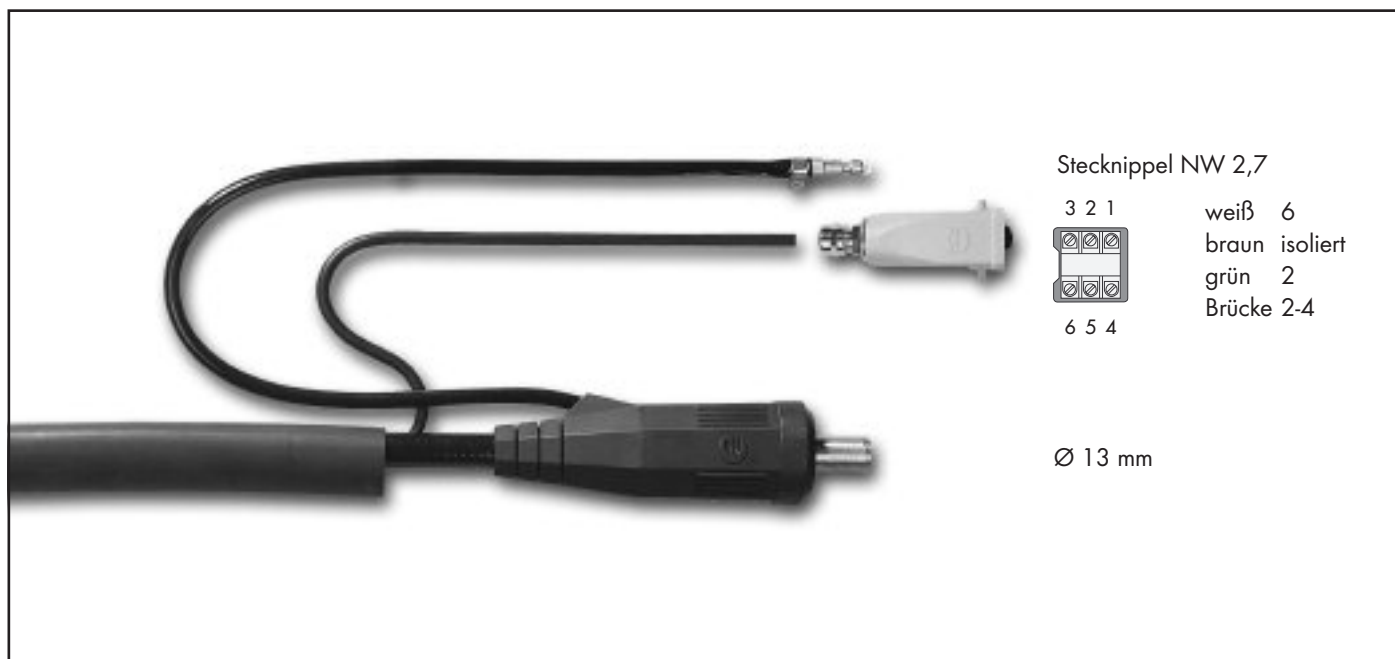

Brennertyp	Länge	Schalterfunktion	maschinenseitiger Anschluss	Schlauchpaketausführung	Bestellnummer
ABITIG® 9	4 m	ED	BSB 35-50 Harting 6-pol.	Standard	7S1SK043510011A04
	8 m	ED	BSB 35-50 Harting 6-pol.	Standard	7S1SK083510011A04
	4 m	ED	BSB 35-50 Harting 6-pol.	High Flex Leder	7S1SH043510011A04
	8 m	ED	BSB 35-50 Harting 6-pol.	High Flex Leder	7S1SH083510011A04
ABITIG® 9 Little	4 m	ED	BSB 35-50 Harting 6-pol.	High Flex Leder	7L1SH043510011A04
	8 m	ED	BSB 35-50 Harting 6-pol.	High Flex Leder	7L1SH083510011A04
ABITIG® 9F	4 m	ED	BSB 35-50 Harting 6-pol.	Standard	7S1FK043510011A04
	8 m	ED	BSB 35-50 Harting 6-pol.	Standard	7S1FK083510011A04
	4 m	ED	BSB 35-50 Harting 6-pol.	High Flex Leder	7S1FH043510011A04
	8 m	ED	BSB 35-50 Harting 6-pol.	High Flex Leder	7S1FH083510011A04
ABITIG® 9F Little	4 m	ED	BSB 35-50 Harting 6-pol.	High Flex Leder	7L1FH043510011A04
	8 m	ED	BSB 35-50 Harting 6-pol.	High Flex Leder	7L1FH083510011A04
ABITIG® 17	4 m	ED	BSB 35-50 Harting 6-pol.	Standard	7S2SK043510011A04
	8 m	ED	BSB 35-50 Harting 6-pol.	Standard	7S2SK083510011A04
	4 m	ED	BSB 35-50 Harting 6-pol.	High Flex Leder	7S2SH043510011A04
	8 m	ED	BSB 35-50 Harting 6-pol.	High Flex Leder	7S2SH083510011A04
ABITIG® 17 Little	4 m	ED	BSB 35-50 Harting 6-pol.	High Flex Leder	7L2SH043510011A04
	8 m	ED	BSB 35-50 Harting 6-pol.	High Flex Leder	7L2SH083510011A04
ABITIG® 17F	4 m	ED	BSB 35-50 Harting 6-pol.	Standard	7S2FK043510011A04
	8 m	ED	BSB 35-50 Harting 6-pol.	Standard	7S2FK083510011A04
	4 m	ED	BSB 35-50 Harting 6-pol.	High Flex Leder	7S2FH043510011A04
	8 m	ED	BSB 35-50 Harting 6-pol.	High Flex Leder	7S2FH083510011A04
ABITIG® 17F Little	4 m	ED	BSB 35-50 Harting 6-pol.	High Flex Leder	7L2FH043510011A04
	8 m	ED	BSB 35-50 Harting 6-pol.	High Flex Leder	7L2FH083510011A04

Technische Änderungen vorbehalten • Verkaufspreise = unverbindliche Preisempfehlung - Angebot freibleibend • © Copyright

ABITIG® GRIP / ABITIG® GRIP Little-Brennerpreisliste

passend für WIG-Stromquellen des Fabrikates „migatronic“

Brennertyp	Länge	Schalterfunktion	maschinenseitiger Anschluss	Schlauchpaketausführung	Bestellnummer
ABITIG® 26	4 m	ED	BSB 35-50 Harting 6-pol.	Standard	7S3SK043510011A04
	8 m	ED	BSB 35-50 Harting 6-pol.	Standard	7S3SK083510011A04
	4 m	ED	BSB 35-50 Harting 6-pol.	High Flex Leder	7S3SH043510011A04
	8 m	ED	BSB 35-50 Harting 6-pol.	High Flex Leder	7S3SH083510011A04
ABITIG® 26F	4 m	ED	BSB 35-50 Harting 6-pol.	Standard	7S3FK043510011A04
	8 m	ED	BSB 35-50 Harting 6-pol.	Standard	7S3FK083510011A04
	4 m	ED	BSB 35-50 Harting 6-pol.	High Flex Leder	7S3FH043510011A04
	8 m	ED	BSB 35-50 Harting 6-pol.	High Flex Leder	7S3FH083510011A04
ABITIG® 24G	4 m	ED	BSB 35-50 Harting 6-pol.	Standard	7S8SK043510011A04
	8 m	ED	BSB 35-50 Harting 6-pol.	Standard	7S8SK083510011A04
	4 m	ED	BSB 35-50 Harting 6-pol.	High Flex Leder	7S8SH043510011A04
	8 m	ED	BSB 35-50 Harting 6-pol.	High Flex Leder	7S8SH083510011A04
ABITIG® 24G Little	4 m	ED	BSB 35-50 Harting 6-pol.	High Flex Leder	7L8SH043510011A04
	8 m	ED	BSB 35-50 Harting 6-pol.	High Flex Leder	7L8SH083510011A04
ABITIG® 200	4 m	ED	BSB 35-50 Harting 6-pol.	Standard	7T4SK043510011A04
	8 m	ED	BSB 35-50 Harting 6-pol.	Standard	7T4SK083510011A04
	4 m	ED	BSB 35-50 Harting 6-pol.	High Flex Leder	7T4SH043510011A04
	8 m	ED	BSB 35-50 Harting 6-pol.	High Flex Leder	7T4SH083510011A04
ABITIG® 200F	4 m	ED	BSB 35-50 Harting 6-pol.	Standard	7T4FK043510011A04
	8 m	ED	BSB 35-50 Harting 6-pol.	Standard	7T4FK083510011A04
	4 m	ED	BSB 35-50 Harting 6-pol.	High Flex Leder	7T4FH043510011A04
	8 m	ED	BSB 35-50 Harting 6-pol.	High Flex Leder	7T4FH083510011A04
ABITIG® 150	4 m	ED	BSB 35-50 Harting 6-pol.	Standard	7T6SK043510011A04
	8 m	ED	BSB 35-50 Harting 6-pol.	Standard	7T6SK083510011A04
	4 m	ED	BSB 35-50 Harting 6-pol.	High Flex Leder	7T6SH043510011A04
	8 m	ED	BSB 35-50 Harting 6-pol.	High Flex Leder	7T6SH083510011A04
ABITIG® 150 Little	4 m	ED	BSB 35-50 Harting 6-pol.	High Flex Leder	7L6SH043510011A04
	8 m	ED	BSB 35-50 Harting 6-pol.	High Flex Leder	7L6SH083510011A04
ABITIG® 150F	4 m	ED	BSB 35-50 Harting 6-pol.	Standard	7T6FK043510011A04
	8 m	ED	BSB 35-50 Harting 6-pol.	Standard	7T6FK083510011A04
	4 m	ED	BSB 35-50 Harting 6-pol.	High Flex Leder	7T6FH043510011A04
	8 m	ED	BSB 35-50 Harting 6-pol.	High Flex Leder	7T6FH083510011A04
ABITIG® 150F Little	4 m	ED	BSB 35-50 Harting 6-pol.	High Flex Leder	7L6FH043510011A04
	8 m	ED	BSB 35-50 Harting 6-pol.	High Flex Leder	7L6FH083510011A04

ABITIG® GRIP / ABITIG® GRIP Little-Brennerpreisliste

passend für WIG-Stromquellen des Fabrikates „migatronic“



Brennertyp	Länge	Schalterfunktion	maschinenseitiger Anschluss	Schlauchpaketausführung	Bestellnummer
ABITIG® 9	4 m	ED	ZA 9-pol.	Standard	7S1SK043510799C00
	8 m	ED	ZA 9-pol.	Standard	7S1SK083510799C00
	4 m	ED	ZA 9-pol.	High Flex Leder	7S1SH043510799C00
	8 m	ED	ZA 9-pol.	High Flex Leder	7S1SH083510799C00
ABITIG® 9 Little	4 m	ED	ZA 9-pol.	High Flex Leder	7L1SH043510799C00
	8 m	ED	ZA 9-pol.	High Flex Leder	7L1SH083510799C00
ABITIG® 9F	4 m	ED	ZA 9-pol.	Standard	7S1FK043510799C00
	8 m	ED	ZA 9-pol.	Standard	7S1FK083510799C00
	4 m	ED	ZA 9-pol.	High Flex Leder	7S1FH043510799C00
	8 m	ED	ZA 9-pol.	High Flex Leder	7S1FH083510799C00
ABITIG® 9F Little	4 m	ED	ZA 9-pol.	High Flex Leder	7L1FH043510799C00
	8 m	ED	ZA 9-pol.	High Flex Leder	7L1FH083510799C00
ABITIG® 17	4 m	ED	ZA 9-pol.	Standard	7S2SK043510799C00
	8 m	ED	ZA 9-pol.	Standard	7S2SK083510799C00
	4 m	ED	ZA 9-pol.	High Flex Leder	7S2SH043510799C00
	8 m	ED	ZA 9-pol.	High Flex Leder	7S2SH083510799C00
ABITIG® 17 Little	4 m	ED	ZA 9-pol.	High Flex Leder	7L2SH043510799C00
	8 m	ED	ZA 9-pol.	High Flex Leder	7L2SH083510799C00
ABITIG® 17F	4 m	ED	ZA 9-pol.	Standard	7S2FK043510799C00
	8 m	ED	ZA 9-pol.	Standard	7S2FK083510799C00
	4 m	ED	ZA 9-pol.	High Flex Leder	7S2FH043510799C00
	8 m	ED	ZA 9-pol.	High Flex Leder	7S2FH083510799C00
ABITIG® 17F Little	4 m	ED	ZA 9-pol.	High Flex Leder	7L2FH043510799C00
	8 m	ED	ZA 9-pol.	High Flex Leder	7L2FH083510799C00

Technische Änderungen vorbehalten • Verkaufspreise = unverbindliche Preisempfehlung - Angebot freibleibend • © Copyright

ABITIG® GRIP / ABITIG® GRIP Little-Brennerpreisliste

passend für WIG-Stromquellen des Fabrikates „migatronic“

Brennertyp	Länge	Schalterfunktion	maschinenseitiger Anschluss	Schlauchpaketausführung	Bestellnummer
ABITIG® 26	4 m	ED	ZA 9-pol.	Standard	7S3SK043510799C00
	8 m	ED	ZA 9-pol.	Standard	7S3SK083510799C00
	4 m	ED	ZA 9-pol.	High Flex Leder	7S3SH043510799C00
	8 m	ED	ZA 9-pol.	High Flex Leder	7S3SH083510799C00
ABITIG® 26F	4 m	ED	ZA 9-pol.	Standard	7S3FK043510799C00
	8 m	ED	ZA 9-pol.	Standard	7S3FK083510799C00
	4 m	ED	ZA 9-pol.	High Flex Leder	7S3FH043510799C00
	8 m	ED	ZA 9-pol.	High Flex Leder	7S3FH083510799C00
ABITIG® 24G	4 m	ED	ZA 9-pol.	Standard	7S8SK043510799C00
	8 m	ED	ZA 9-pol.	Standard	7S8SK083510799C00
	4 m	ED	ZA 9-pol.	High Flex Leder	7S8SH043510799C00
	8 m	ED	ZA 9-pol.	High Flex Leder	7S8SH083510799C00
ABITIG® 24G Little	4 m	ED	ZA 9-pol.	High Flex Leder	7L8SH043510799C00
	8 m	ED	ZA 9-pol.	High Flex Leder	7L8SH083510799C00
ABITIG® 200	4 m	ED	ZA 9-pol.	Standard	7T4SK043510799C00
	8 m	ED	ZA 9-pol.	Standard	7T4SK083510799C00
	4 m	ED	ZA 9-pol.	High Flex Leder	7T4SH043510799C00
	8 m	ED	ZA 9-pol.	High Flex Leder	7T4SH083510799C00
ABITIG® 200F	4 m	ED	ZA 9-pol.	Standard	7T4FK043510799C00
	8 m	ED	ZA 9-pol.	Standard	7T4FK083510799C00
	4 m	ED	ZA 9-pol.	High Flex Leder	7T4FH043510799C00
	8 m	ED	ZA 9-pol.	High Flex Leder	7T4FH083510799C00
ABITIG® 150	4 m	ED	ZA 9-pol.	Standard	7T6SK043510799C00
	8 m	ED	ZA 9-pol.	Standard	7T6SK083510799C00
	4 m	ED	ZA 9-pol.	High Flex Leder	7T6SH043510799C00
	8 m	ED	ZA 9-pol.	High Flex Leder	7T6SH083510799C00
ABITIG® 150 Little	4 m	ED	ZA 9-pol.	High Flex Leder	7L6SH043510799C00
	8 m	ED	ZA 9-pol.	High Flex Leder	7L6SH083510799C00
ABITIG® 150F	4 m	ED	ZA 9-pol.	Standard	7T6FK043510799C00
	8 m	ED	ZA 9-pol.	Standard	7T6FK083510799C00
	4 m	ED	ZA 9-pol.	High Flex Leder	7T6FH043510799C00
	8 m	ED	ZA 9-pol.	High Flex Leder	7T6FH083510799C00
ABITIG® 150F Little	4 m	ED	ZA 9-pol.	High Flex Leder	7L6FH043510799C00
	8 m	ED	ZA 9-pol.	High Flex Leder	7L6FH083510799C00

ABITIG® GRIP / ABITIG® GRIP Little-Brennerpreisliste

passend für WIG-Stromquellen des Fabrikates „migatronic“



Brennertyp	Länge	Schalterfunktion	maschinenseitiger Anschluss	Schlauchpaketausführung	Bestellnummer
ABITIG® 9	4 m	EDP	ZA 9-pol.	Standard	7S1SK043590799C00
	8 m	EDP	ZA 9-pol.	Standard	7S1SK083590799C00
	4 m	EDP	ZA 9-pol.	High Flex Leder	7S1SH043590799C00
	8 m	EDP	ZA 9-pol.	High Flex Leder	7S1SH083590799C00
ABITIG® 9F	4 m	EDP	ZA 9-pol.	Standard	7S1FK043590799C00
	8 m	EDP	ZA 9-pol.	Standard	7S1FK083590799C00
	4 m	EDP	ZA 9-pol.	High Flex Leder	7S1FH043590799C00
	8 m	EDP	ZA 9-pol.	High Flex Leder	7S1FH083590799C00
ABITIG® 17	4 m	EDP	ZA 9-pol.	Standard	7S2SK043590799C00
	8 m	EDP	ZA 9-pol.	Standard	7S2SK083590799C00
	4 m	EDP	ZA 9-pol.	High Flex Leder	7S2SH043590799C00
	8 m	EDP	ZA 9-pol.	High Flex Leder	7S2SH083510799C00
ABITIG® 17F	4 m	EDP	ZA 9-pol.	Standard	7S2FK043590799C00
	8 m	EDP	ZA 9-pol.	Standard	7S2FK083590799C00
	4 m	EDP	ZA 9-pol.	High Flex Leder	7S2FH043590799C00
	8 m	EDP	ZA 9-pol.	High Flex Leder	7S2FH083590799C00

Technische Änderungen vorbehalten • Verkaufspreise = unverbindliche Preisempfehlung - Angebot freibleibend • © Copyright

ABITIG® GRIP / ABITIG® GRIP Little-Brennerpreisliste

passend für WIG-Stromquellen des Fabrikates „migatronik“

Brennertyp	Länge	Schalterfunktion	maschinenseitiger Anschluss	Schlauchpaketausführung	Bestellnummer
ABITIG® 26	4 m	EDP	ZA 9-pol.	Standard	7S3SK043590799C00
	8 m	EDP	ZA 9-pol.	Standard	7S3SK083590799C00
	4 m	EDP	ZA 9-pol.	High Flex Leder	7S3SH043590799C00
	8 m	EDP	ZA 9-pol.	High Flex Leder	7S3SH083590799C00
ABITIG® 26F	4 m	EDP	ZA 9-pol.	Standard	7S3FK043590799C00
	8 m	EDP	ZA 9-pol.	Standard	7S3FK083590799C00
	4 m	EDP	ZA 9-pol.	High Flex Leder	7S3FH043590799C00
	8 m	EDP	ZA 9-pol.	High Flex Leder	7S3FH083590799C00
ABITIG® 24G	4 m	EDP	ZA 9-pol.	Standard	7S8SK043590799C00
	8 m	EDP	ZA 9-pol.	Standard	7S8SK083590799C00
	4 m	EDP	ZA 9-pol.	High Flex Leder	7S8SH043590799C00
	8 m	EDP	ZA 9-pol.	High Flex Leder	7S8SH083590799C00
ABITIG® 200	4 m	EDP	ZA 9-pol.	Standard	7T4SK043590799C00
	8 m	EDP	ZA 9-pol.	Standard	7T4SK083590799C00
	4 m	EDP	ZA 9-pol.	High Flex Leder	7T4SH043590799C00
	8 m	EDP	ZA 9-pol.	High Flex Leder	7T4SH083590799C00
ABITIG® 200F	4 m	EDP	ZA 9-pol.	Standard	7T4FK043590799C00
	8 m	EDP	ZA 9-pol.	Standard	7T4FK083590799C00
	4 m	EDP	ZA 9-pol.	High Flex Leder	7T4FH043590799C00
	8 m	EDP	ZA 9-pol.	High Flex Leder	7T4FH083590799C00
ABITIG® 150	4 m	EDP	ZA 9-pol.	Standard	7T6SK043590799C00
	8 m	EDP	ZA 9-pol.	Standard	7T6SK083590799C00
	4 m	EDP	ZA 9-pol.	High Flex Leder	7T6SH043590799C00
	8 m	EDP	ZA 9-pol.	High Flex Leder	7T6SH083590799C00
ABITIG® 150F	4 m	EDP	ZA 9-pol.	Standard	7T6FK043590799C00
	8 m	EDP	ZA 9-pol.	Standard	7T6FK083590799C00
	4 m	EDP	ZA 9-pol.	High Flex Leder	7T6FH043590799C00
	8 m	EDP	ZA 9-pol.	High Flex Leder	7T6FH083590799C00

ABITIG® GRIP / ABITIG® GRIP Little-Brennerpreisliste

passend für WIG-Stromquellen des Fabrikates „migatronic“

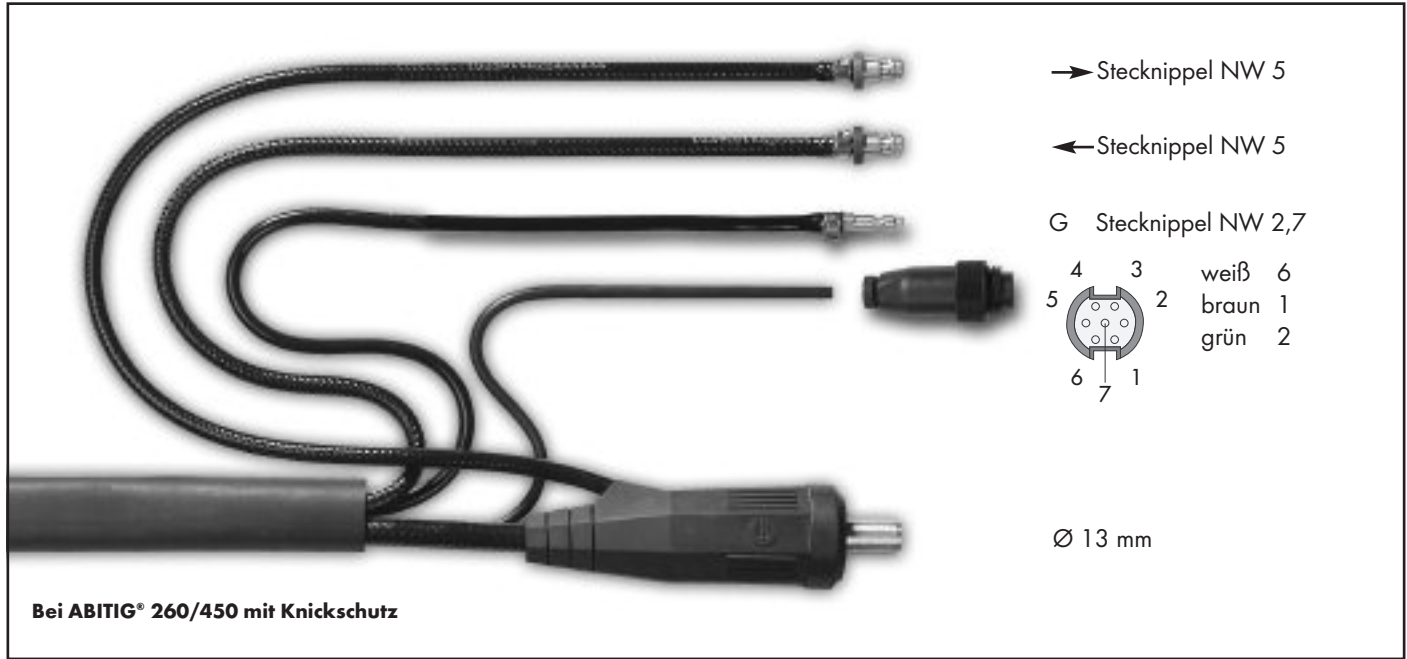

Brennertyp	Länge	Schalterfunktion	maschinenseitiger Anschluss	Schlauchpaketausführung	Bestellnummer
ABITIG® 18	4 m	EDP	BSB 35-50 Rundsteckverbinder 7-pol.	Standard	7S4SK043590025D22
	8 m	EDP	BSB 35-50 Rundsteckverbinder 7-pol.	Standard	7S4SK083590025D22
	4 m	EDP	BSB 35-50 Rundsteckverbinder 7-pol.	High Flex Leder	7S4SH043590025D22
	8 m	EDP	BSB 35-50 Rundsteckverbinder 7-pol.	High Flex Leder	7S4SH083590025D22
ABITIG® 18F	4 m	EDP	BSB 35-50 Rundsteckverbinder 7-pol.	Standard	7S4FK043590025D22
	8 m	EDP	BSB 35-50 Rundsteckverbinder 7-pol.	Standard	7S4FK083590025D22
	4 m	EDP	BSB 35-50 Rundsteckverbinder 7-pol.	High Flex Leder	7S4FH043590025D22
	8 m	EDP	BSB 35-50 Rundsteckverbinder 7-pol.	High Flex Leder	7S4FH083590025D22
ABITIG® 20	4 m	EDP	BSB 35-50 Rundsteckverbinder 7-pol.	Standard	7S5SK043590025D22
	8 m	EDP	BSB 35-50 Rundsteckverbinder 7-pol.	Standard	7S5SK083590025D22
	4 m	EDP	BSB 35-50 Rundsteckverbinder 7-pol.	High Flex Leder	7S5SH043590025D22
	8 m	EDP	BSB 35-50 Rundsteckverbinder 7-pol.	High Flex Leder	7S5SH083590025D22
ABITIG® 20F	4 m	EDP	BSB 35-50 Rundsteckverbinder 7-pol.	Standard	7S5FK043590025D22
	8 m	EDP	BSB 35-50 Rundsteckverbinder 7-pol.	Standard	7S5FK083590025D22
	4 m	EDP	BSB 35-50 Rundsteckverbinder 7-pol.	High Flex Leder	7S5FH043590025D22
	8 m	EDP	BSB 35-50 Rundsteckverbinder 7-pol.	High Flex Leder	7S5FH083590025D22

Technische Änderungen vorbehalten • Verkaufspreise = unverbindliche Preisempfehlung - Angebot freibleibend • © Copyright

ABITIG® GRIP / ABITIG® GRIP Little-Brennerpreisliste

passend für WIG-Stromquellen des Fabrikates „migatronic“

Brennertyp	Länge	Schalterfunktion	maschinenseitiger Anschluss	Schlauchpaketausführung	Bestellnummer
ABITIG® 12-1	4 m	EDP	BSB 35-50 Rundsteckverbinder 7-pol.	Standard	7S6SK043590025D22
	8 m	EDP	BSB 35-50 Rundsteckverbinder 7-pol.	Standard	7S6SK083590025D22
	4 m	EDP	BSB 35-50 Rundsteckverbinder 7-pol.	High Flex Leder	7S6SH043590025D22
	8 m	EDP	BSB 35-50 Rundsteckverbinder 7-pol.	High Flex Leder	7S6SH083590025D22
ABITIG® 18SC	4 m	EDP	BSB 35-50 Rundsteckverbinder 7-pol.	Standard	7S7SK043590025D22
	8 m	EDP	BSB 35-50 Rundsteckverbinder 7-pol.	Standard	7S7SK083590025D22
	4 m	EDP	BSB 35-50 Rundsteckverbinder 7-pol.	High Flex Leder	7S7SH043590025D22
	8 m	EDP	BSB 35-50 Rundsteckverbinder 7-pol.	High Flex Leder	7S7SH083590025D22
ABITIG® 24W	4 m	EDP	BSB 35-50 Rundsteckverbinder 7-pol.	Standard	7S9SK043590025D22
	8 m	EDP	BSB 35-50 Rundsteckverbinder 7-pol.	Standard	7S9SK083590025D22
	4 m	EDP	BSB 35-50 Rundsteckverbinder 7-pol.	High Flex Leder	7S9SH043590025D22
	8 m	EDP	BSB 35-50 Rundsteckverbinder 7-pol.	High Flex Leder	7S9SH083590025D22
ABITIG® 450W	4 m	EDP	BSB 35-50 Rundsteckverbinder 7-pol.	Standard	7T5SK043590125D22
	8 m	EDP	BSB 35-50 Rundsteckverbinder 7-pol.	Standard	7T5SK083590125D22
	4 m	EDP	BSB 35-50 Rundsteckverbinder 7-pol.	High Flex Leder	7T5SH043590125D22
	8 m	EDP	BSB 35-50 Rundsteckverbinder 7-pol.	High Flex Leder	7T5SH083590125D22
ABITIG® 260W	4 m	EDP	BSB 35-50 Rundsteckverbinder 7-pol.	Standard	7T7SK043590125D22
	8 m	EDP	BSB 35-50 Rundsteckverbinder 7-pol.	Standard	7T7SK083590125D22
	4 m	EDP	BSB 35-50 Rundsteckverbinder 7-pol.	High Flex Leder	7T7SH043590125D22
	8 m	EDP	BSB 35-50 Rundsteckverbinder 7-pol.	High Flex Leder	7T7SH083590125D22
ABITIG® 450W SC	4 m	EDP	BSB 35-50 Rundsteckverbinder 7-pol.	Standard	
	8 m	EDP	BSB 35-50 Rundsteckverbinder 7-pol.	Standard	
	4 m	EDP	BSB 35-50 Rundsteckverbinder 7-pol.	High Flex Leder	7T8SH043590125D22
	8 m	EDP	BSB 35-50 Rundsteckverbinder 7-pol.	High Flex Leder	7T8SH083590125D22

ABITIG® GRIP / ABITIG® GRIP Little-Brennerpreisliste

passend für WIG-Stromquellen des Fabrikates „migatronic“

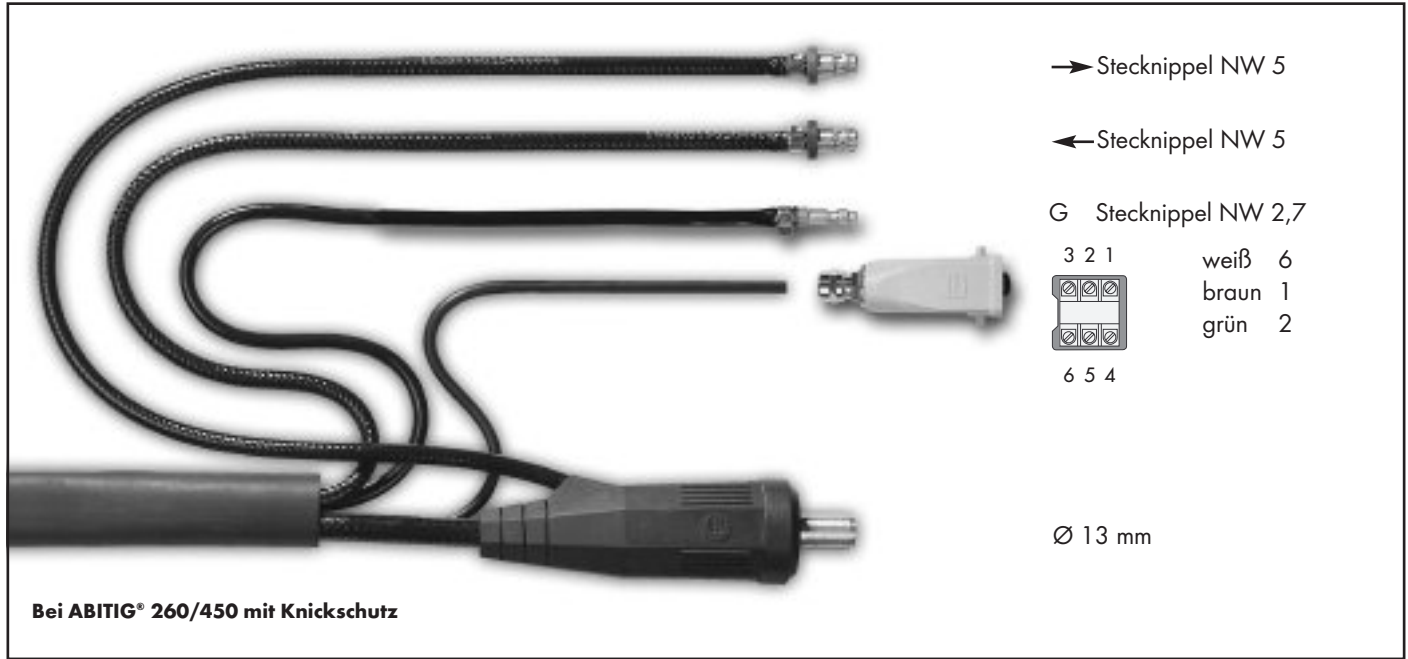

Brennertyp	Länge	Schalterfunktion	maschinenseitiger Anschluss	Schlauchpaketausführung	Bestellnummer
ABITIG® 18	4 m	EDP	BSB 35-50 Harting 6-pol.	Standard	7S4SK043590011D22
	8 m	EDP	BSB 35-50 Harting 6-pol.	Standard	7S4SK083590011D22
	4 m	EDP	BSB 35-50 Harting 6-pol.	High Flex Leder	7S4SH043590011D22
	8 m	EDP	BSB 35-50 Harting 6-pol.	High Flex Leder	7S4SH083590011D22
ABITIG® 18F	4 m	EDP	BSB 35-50 Harting 6-pol.	Standard	7S4FK043590011D22
	8 m	EDP	BSB 35-50 Harting 6-pol.	Standard	7S4FK083590011D22
	4 m	EDP	BSB 35-50 Harting 6-pol.	High Flex Leder	7S4FH043590011D22
	8 m	EDP	BSB 35-50 Harting 6-pol.	High Flex Leder	7S4FH083590011D22
ABITIG® 20	4 m	EDP	BSB 35-50 Harting 6-pol.	Standard	7S5SK043590011D22
	8 m	EDP	BSB 35-50 Harting 6-pol.	Standard	7S5SK083590011D22
	4 m	EDP	BSB 35-50 Harting 6-pol.	High Flex Leder	7S5SH043590011D22
	8 m	EDP	BSB 35-50 Harting 6-pol.	High Flex Leder	7S5SH083590011D22
ABITIG® 20F	4 m	EDP	BSB 35-50 Harting 6-pol.	Standard	7S5FK043590011D22
	8 m	EDP	BSB 35-50 Harting 6-pol.	Standard	7S5FK083590011D22
	4 m	EDP	BSB 35-50 Harting 6-pol.	High Flex Leder	7S5FH043590011D22
	8 m	EDP	BSB 35-50 Harting 6-pol.	High Flex Leder	7S5FH083590011D22

Technische Änderungen vorbehalten • Verkaufspreise = unverbindliche Preisempfehlung - Angebot freibleibend • © Copyright

ABITIG® GRIP / ABITIG® GRIP Little-Brennerpreisliste

passend für WIG-Stromquellen des Fabrikates „migatronic“

Brennertyp	Länge	Schalterfunktion	maschinenseitiger Anschluss	Schlauchpaketausführung	Bestellnummer
ABITIG® 12-1	4 m	EDP	BSB 35-50 Harting 6-pol.	Standard	7S6SK043590011D22
	8 m	EDP	BSB 35-50 Harting 6-pol.	Standard	7S6SK083590011D22
	4 m	EDP	BSB 35-50 Harting 6-pol.	High Flex Leder	7S6SH043590011D22
	8 m	EDP	BSB 35-50 Harting 6-pol.	High Flex Leder	7S6SH083590011D22
ABITIG® 18SC	4 m	EDP	BSB 35-50 Harting 6-pol.	Standard	7S7SK043590011D22
	8 m	EDP	BSB 35-50 Harting 6-pol.	Standard	7S7SK083590011D22
	4 m	EDP	BSB 35-50 Harting 6-pol.	High Flex Leder	7S7SH043590011D22
	8 m	EDP	BSB 35-50 Harting 6-pol.	High Flex Leder	7S7SH083590011D22
ABITIG® 24W	4 m	EDP	BSB 35-50 Harting 6-pol.	Standard	7S9SK043590011D22
	8 m	EDP	BSB 35-50 Harting 6-pol.	Standard	7S9SK083590011D22
	4 m	EDP	BSB 35-50 Harting 6-pol.	High Flex Leder	7S9SH043590011D22
	8 m	EDP	BSB 35-50 Harting 6-pol.	High Flex Leder	7S9SH083590011D22
ABITIG® 450W	4 m	EDP	BSB 35-50 Harting 6-pol.	Standard	7T5SK043590111D22
	8 m	EDP	BSB 35-50 Harting 6-pol.	Standard	7T5SK083590111D22
	4 m	EDP	BSB 35-50 Harting 6-pol.	High Flex Leder	7T5SH043590111D22
	8 m	EDP	BSB 35-50 Harting 6-pol.	High Flex Leder	7T5SH083590111D22
ABITIG® 260W	4 m	EDP	BSB 35-50 Harting 6-pol.	Standard	7T7SK043590111D22
	8 m	EDP	BSB 35-50 Harting 6-pol.	Standard	7T7SK083590111D22
	4 m	EDP	BSB 35-50 Harting 6-pol.	High Flex Leder	7T7SH043590111D22
	8 m	EDP	BSB 35-50 Harting 6-pol.	High Flex Leder	7T7SH083590111D22
ABITIG® 450W SC	4 m	EDP	BSB 35-50 Harting 6-pol.	Standard	
	8 m	EDP	BSB 35-50 Harting 6-pol.	Standard	
	4 m	EDP	BSB 35-50 Harting 6-pol.	High Flex Leder	7T8SH043590111D22
	8 m	EDP	BSB 35-50 Harting 6-pol.	High Flex Leder	7T8SH083590111D22

ABITIG® GRIP / ABITIG® GRIP Little-Brennerpreisliste

passend für WIG-Stromquellen des Fabrikates „migatronic“

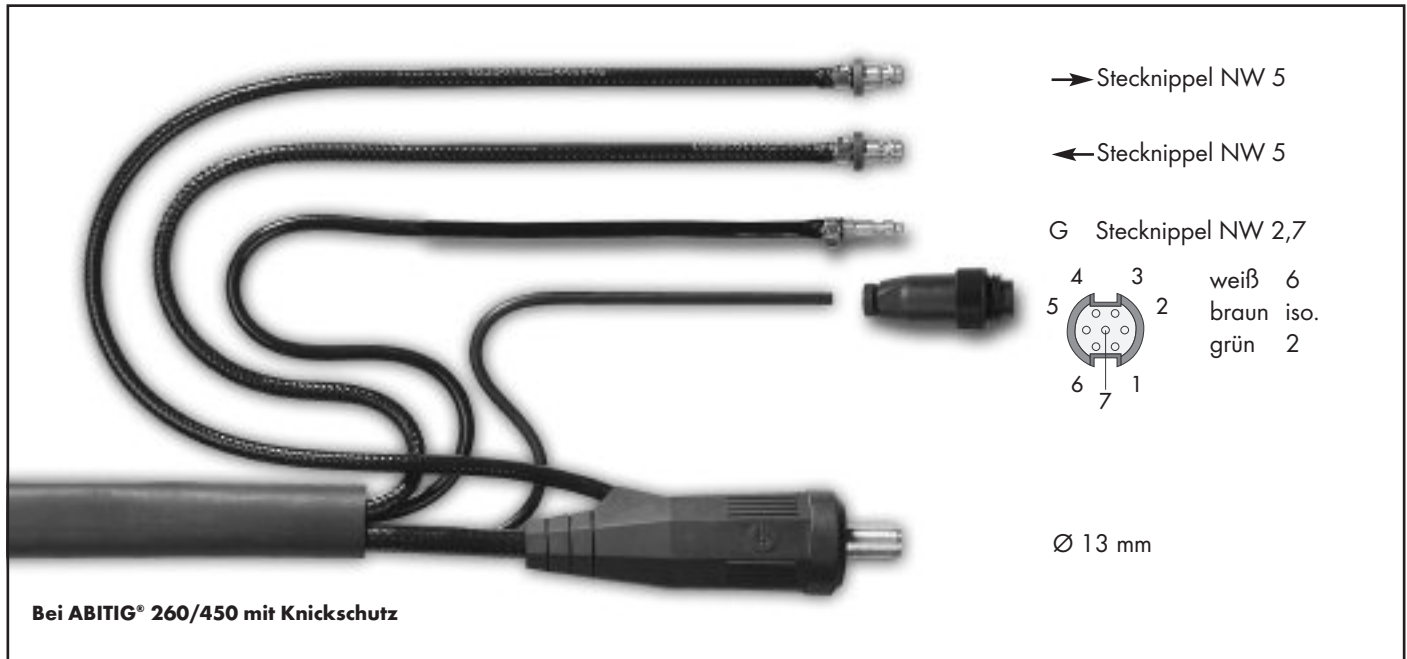

Brennertyp	Länge	Schalterfunktion	maschinenseitiger Anschluss	Schlauchpaketausführung	Bestellnummer
ABITIG® 18	4 m	ED	BSB 35-50 Rundsteckverbinder 7-pol.	Standard	7S4SK043510025C22
	8 m	ED	BSB 35-50 Rundsteckverbinder 7-pol.	Standard	7S4SK083510025C22
	4 m	ED	BSB 35-50 Rundsteckverbinder 7-pol.	High Flex Leder	7S4SH043510025C22
	8 m	ED	BSB 35-50 Rundsteckverbinder 7-pol.	High Flex Leder	7S4SH083510025C22
ABITIG® 18F	4 m	ED	BSB 35-50 Rundsteckverbinder 7-pol.	Standard	7S4FK043510025C22
	8 m	ED	BSB 35-50 Rundsteckverbinder 7-pol.	Standard	7S4FK083510025C22
	4 m	ED	BSB 35-50 Rundsteckverbinder 7-pol.	High Flex Leder	7S4FH043510025C22
	8 m	ED	BSB 35-50 Rundsteckverbinder 7-pol.	High Flex Leder	7S4FH083510025C22
ABITIG® 20	4 m	ED	BSB 35-50 Rundsteckverbinder 7-pol.	Standard	7S5SK043510025C22
	8 m	ED	BSB 35-50 Rundsteckverbinder 7-pol.	Standard	7S5SK083510025C22
	4 m	ED	BSB 35-50 Rundsteckverbinder 7-pol.	High Flex Leder	7S5SH043510025C22
	8 m	ED	BSB 35-50 Rundsteckverbinder 7-pol.	High Flex Leder	7S5SH083510025C22
ABITIG® 20 Little	4 m	ED	BSB 35-50 Rundsteckverbinder 7-pol.	High Flex Leder	7L5SH043510025C22
	8 m	ED	BSB 35-50 Rundsteckverbinder 7-pol.	High Flex Leder	7L5SH083510025C22
ABITIG® 20F	4 m	ED	BSB 35-50 Rundsteckverbinder 7-pol.	Standard	7S5FK043510025C22
	8 m	ED	BSB 35-50 Rundsteckverbinder 7-pol.	Standard	7S5FK083510025C22
	4 m	ED	BSB 35-50 Rundsteckverbinder 7-pol.	High Flex Leder	7S5FH043510025C22
	8 m	ED	BSB 35-50 Rundsteckverbinder 7-pol.	High Flex Leder	7S5FH083510025C22
ABITIG® 20F Little	4 m	ED	BSB 35-50 Rundsteckverbinder 7-pol.	High Flex Leder	7L5FH043510025C22
	8 m	ED	BSB 35-50 Rundsteckverbinder 7-pol.	High Flex Leder	7L5FH083510025C22

Technische Änderungen vorbehalten • Verkaufspreise = unverbindliche Preisempfehlung - Angebot freibleibend • © Copyright

ABITIG® GRIP / ABITIG® GRIP Little-Brennerpreisliste

passend für WIG-Stromquellen des Fabrikates „migatronic“

Brennertyp	Länge	Schalterfunktion	maschinenseitiger Anschluss	Schlauchpaketausführung	Bestellnummer
ABITIG® 12-1	4 m	ED	BSB 35-50 Rundsteckverbinder 7-pol.	Standard	7S6SK043510025C22
	8 m	ED	BSB 35-50 Rundsteckverbinder 7-pol.	Standard	7S6SK083510025C22
	4 m	ED	BSB 35-50 Rundsteckverbinder 7-pol.	High Flex Leder	7S6SH043510025C22
	8 m	ED	BSB 35-50 Rundsteckverbinder 7-pol.	High Flex Leder	7S6SH083510025C22
ABITIG® 18SC	4 m	ED	BSB 35-50 Rundsteckverbinder 7-pol.	Standard	7S7SK043510025C22
	8 m	ED	BSB 35-50 Rundsteckverbinder 7-pol.	Standard	7S7SK083510025C22
	4 m	ED	BSB 35-50 Rundsteckverbinder 7-pol.	High Flex Leder	7S7SH043510025C22
	8 m	ED	BSB 35-50 Rundsteckverbinder 7-pol.	High Flex Leder	7S7SH083510025C22
ABITIG® 24W	4 m	ED	BSB 35-50 Rundsteckverbinder 7-pol.	Standard	7S9SK043510025C22
	8 m	ED	BSB 35-50 Rundsteckverbinder 7-pol.	Standard	7S9SK083510025C22
	4 m	ED	BSB 35-50 Rundsteckverbinder 7-pol.	High Flex Leder	7S9SH043510025C22
	8 m	ED	BSB 35-50 Rundsteckverbinder 7-pol.	High Flex Leder	7S9SH083510025C22
ABITIG® 24W Little	4 m	ED	BSB 35-50 Rundsteckverbinder 7-pol.	High Flex Leder	7L9SH043510025C22
	8 m	ED	BSB 35-50 Rundsteckverbinder 7-pol.	High Flex Leder	7L9SH083510025C22
ABITIG® 450W	4 m	ED	BSB 35-50 Rundsteckverbinder 7-pol.	Standard	7T5SK043510125C22
	8 m	ED	BSB 35-50 Rundsteckverbinder 7-pol.	Standard	7T5SK083510125C22
	4 m	ED	BSB 35-50 Rundsteckverbinder 7-pol.	High Flex Leder	7T5SH043510125C22
	8 m	ED	BSB 35-50 Rundsteckverbinder 7-pol.	High Flex Leder	7T5SH083510125C22
ABITIG® 260W	4 m	ED	BSB 35-50 Rundsteckverbinder 7-pol.	Standard	7T7SK043510125C22
	8 m	ED	BSB 35-50 Rundsteckverbinder 7-pol.	Standard	7T7SK083510125C22
	4 m	ED	BSB 35-50 Rundsteckverbinder 7-pol.	High Flex Leder	7T7SH043510125C22
	8 m	ED	BSB 35-50 Rundsteckverbinder 7-pol.	High Flex Leder	7T7SH083510125C22
ABITIG® 260W Little	4 m	ED	BSB 35-50 Rundsteckverbinder 7-pol.	High Flex Leder	7L7SH043510125C22
	8 m	ED	BSB 35-50 Rundsteckverbinder 7-pol.	High Flex Leder	7L7SH083510125C22
ABITIG® 450W SC	4 m	ED	BSB 35-50 Rundsteckverbinder 7-pol.	Standard	
	8 m	ED	BSB 35-50 Rundsteckverbinder 7-pol.	Standard	
	4 m	ED	BSB 35-50 Rundsteckverbinder 7-pol.	High Flex Leder	7T8SH043510125C22
	8 m	ED	BSB 35-50 Rundsteckverbinder 7-pol.	High Flex Leder	7T8SH083510125C22

ABITIG® GRIP / ABITIG® GRIP Little-Brennerpreisliste

passend für WIG-Stromquellen des Fabrikates „migatronic“

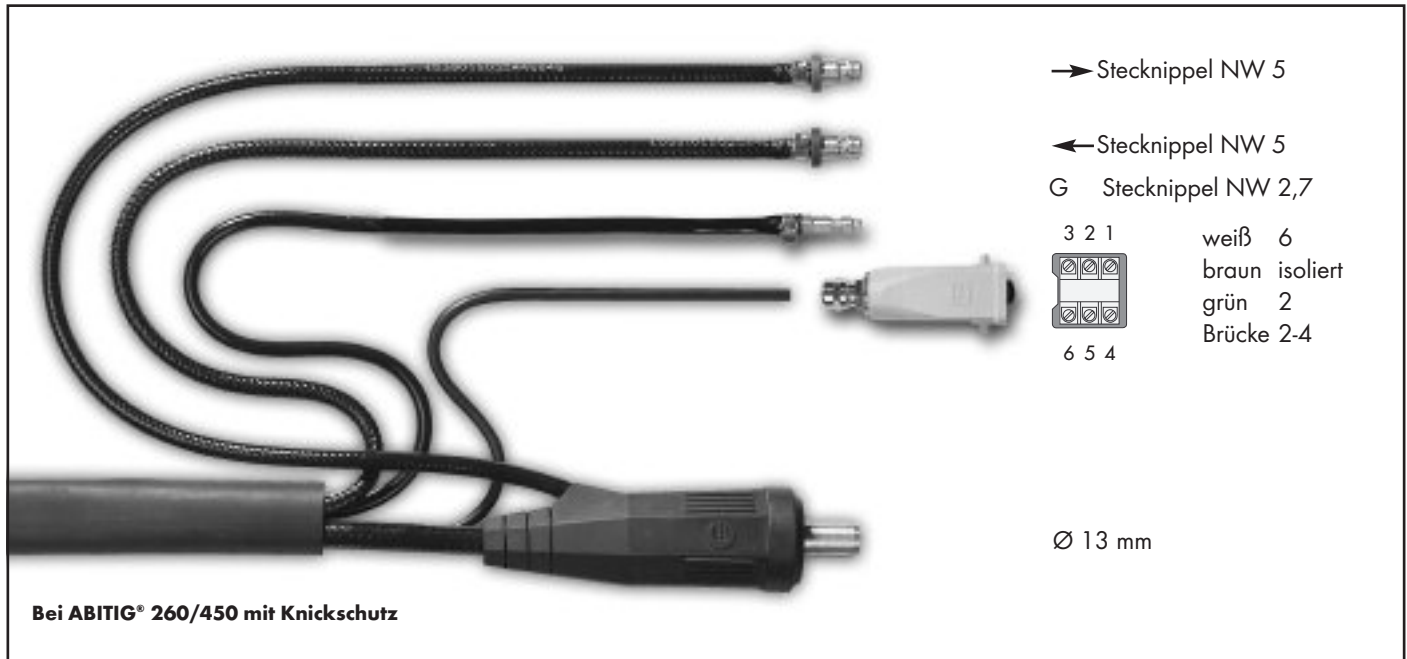

Brennertyp	Länge	Schalterfunktion	maschinenseitiger Anschluss	Schlauchpaketausführung	Bestellnummer
ABITIG® 18	4 m	ED	BSB 35-50 Harting 6-pol.	Standard	7S4SK043510011C22
	8 m	ED	BSB 35-50 Harting 6-pol.	Standard	7S4SK083510011C22
	4 m	ED	BSB 35-50 Harting 6-pol.	High Flex Leder	7S4SH043510011C22
	8 m	ED	BSB 35-50 Harting 6-pol.	High Flex Leder	7S4SH083510011C22
ABITIG® 18F	4 m	ED	BSB 35-50 Harting 6-pol.	Standard	7S4FK043510011C22
	8 m	ED	BSB 35-50 Harting 6-pol.	Standard	7S4FK083510011C22
	4 m	ED	BSB 35-50 Harting 6-pol.	High Flex Leder	7S4FH043510011C22
	8 m	ED	BSB 35-50 Harting 6-pol.	High Flex Leder	7S4FH083510011C22
ABITIG® 20	4 m	ED	BSB 35-50 Harting 6-pol.	Standard	7S5SK043510011C22
	8 m	ED	BSB 35-50 Harting 6-pol.	Standard	7S5SK083510011C22
	4 m	ED	BSB 35-50 Harting 6-pol.	High Flex Leder	7S5SH043510011C22
	8 m	ED	BSB 35-50 Harting 6-pol.	High Flex Leder	7S5SH083510011C22
ABITIG® 20 Little	4 m	ED	BSB 35-50 Harting 6-pol.	High Flex Leder	7L5SH043510011C22
	8 m	ED	BSB 35-50 Harting 6-pol.	High Flex Leder	7L5SH083510011C22
ABITIG® 20F	4 m	ED	BSB 35-50 Harting 6-pol.	Standard	7S5FK043510011C22
	8 m	ED	BSB 35-50 Harting 6-pol.	Standard	7S5FK083510011C22
	4 m	ED	BSB 35-50 Harting 6-pol.	High Flex Leder	7S5FH043510011C22
	8 m	ED	BSB 35-50 Harting 6-pol.	High Flex Leder	7S5FH083510011C22
ABITIG® 20F Little	4 m	ED	BSB 35-50 Harting 6-pol.	High Flex Leder	7L5FH043510011C22
	8 m	ED	BSB 35-50 Harting 6-pol.	High Flex Leder	7L5FH083510011C22

Technische Änderungen vorbehalten • Verkaufspreise = unverbindliche Preisempfehlung - Angebot freibleibend • © Copyright

ABITIG® GRIP / ABITIG® GRIP Little-Brennerpreisliste

passend für WIG-Stromquellen des Fabrikates „migatronik“

Brennertyp	Länge	Schalterfunktion	maschinenseitiger Anschluss	Schlauchpaketausführung	Bestellnummer
ABITIG® 12-1	4 m	ED	BSB 35-50 Harting 6-pol.	Standard	7S6SK043510011C22
	8 m	ED	BSB 35-50 Harting 6-pol.	Standard	7S6SK083510011C22
	4 m	ED	BSB 35-50 Harting 6-pol.	High Flex Leder	7S6SH043510011C22
	8 m	ED	BSB 35-50 Harting 6-pol.	High Flex Leder	7S6SH083510011C22
ABITIG® 18SC	4 m	ED	BSB 35-50 Harting 6-pol.	Standard	7S7SK043510011C22
	8 m	ED	BSB 35-50 Harting 6-pol.	Standard	7S7SK083510011C22
	4 m	ED	BSB 35-50 Harting 6-pol.	High Flex Leder	7S7SH043510011C22
	8 m	ED	BSB 35-50 Harting 6-pol.	High Flex Leder	7S7SH083510011C22
ABITIG® 24W	4 m	ED	BSB 35-50 Harting 6-pol.	Standard	7S9SK043510011C22
	8 m	ED	BSB 35-50 Harting 6-pol.	Standard	7S9SK083510011C22
	4 m	ED	BSB 35-50 Harting 6-pol.	High Flex Leder	7S9SH043510011C22
	8 m	ED	BSB 35-50 Harting 6-pol.	High Flex Leder	7S9SH083510011C22
ABITIG® 24W Little	4 m	ED	BSB 35-50 Harting 6-pol.	High Flex Leder	7L9SH043510011C22
	8 m	ED	BSB 35-50 Harting 6-pol.	High Flex Leder	7L9SH083510011C22
ABITIG® 450W	4 m	ED	BSB 35-50 Harting 6-pol.	Standard	7T5SK043510111C22
	8 m	ED	BSB 35-50 Harting 6-pol.	Standard	7T5SK083510111C22
	4 m	ED	BSB 35-50 Harting 6-pol.	High Flex Leder	7T5SH043510111C22
	8 m	ED	BSB 35-50 Harting 6-pol.	High Flex Leder	7T5SH083510111C22
ABITIG® 260W	4 m	ED	BSB 35-50 Harting 6-pol.	Standard	7T7SK043510111C22
	8 m	ED	BSB 35-50 Harting 6-pol.	Standard	7T7SK083510111C22
	4 m	ED	BSB 35-50 Harting 6-pol.	High Flex Leder	7T7SH043510111C22
	8 m	ED	BSB 35-50 Harting 6-pol.	High Flex Leder	7T7SH083510111C22
ABITIG® 260W Little	4 m	ED	BSB 35-50 Harting 6-pol.	High Flex Leder	7L7SH043510111C22
	8 m	ED	BSB 35-50 Harting 6-pol.	High Flex Leder	7L7SH083510111C22
ABITIG® 450W SC	4 m	ED	BSB 35-50 Harting 6-pol.	Standard	
	8 m	ED	BSB 35-50 Harting 6-pol.	Standard	
	4 m	ED	BSB 35-50 Harting 6-pol.	High Flex Leder	7T8SH043510111C22
	8 m	ED	BSB 35-50 Harting 6-pol.	High Flex Leder	7T8SH083510111C22

ABITIG® GRIP / ABITIG® GRIP Little-Brennerpreisliste

passend für WIG-Stromquellen des Fabrikates „migatronic“



Brennertyp	Länge	Schalterfunktion	maschinenseitiger Anschluss	Schlauchpaketausführung	Bestellnummer
ABITIG® 18	4 m	ED	ZA 9-pol.	Standard	7S4SK043510799D12
	8 m	ED	ZA 9-pol.	Standard	7S4SK083510799D12
	4 m	ED	ZA 9-pol.	High Flex Leder	7S4SH043510799D12
	8 m	ED	ZA 9-pol.	High Flex Leder	7S4SH083510799D12
ABITIG® 18F	4 m	ED	ZA 9-pol.	Standard	7S4FK043510799D12
	8 m	ED	ZA 9-pol.	Standard	7S4FK083510799D12
	4 m	ED	ZA 9-pol.	High Flex Leder	7S4FH043510799D12
	8 m	ED	ZA 9-pol.	High Flex Leder	7S4FH083510799D12
ABITIG® 20	4 m	ED	ZA 9-pol.	Standard	7S5SK043510799D12
	8 m	ED	ZA 9-pol.	Standard	7S5SK083510799D12
	4 m	ED	ZA 9-pol.	High Flex Leder	7S5SH043510799D12
	8 m	ED	ZA 9-pol.	High Flex Leder	7S5SH083510799D12
ABITIG® 20 Little	4 m	ED	ZA 9-pol.	High Flex Leder	7L5SH043510799D12
	8 m	ED	ZA 9-pol.	High Flex Leder	7L5SH083510799D12
ABITIG® 20F	4 m	ED	ZA 9-pol.	Standard	7S5FK043510799D12
	8 m	ED	ZA 9-pol.	Standard	7S5FK083510799D12
	4 m	ED	ZA 9-pol.	High Flex Leder	7S5FH043510799D12
	8 m	ED	ZA 9-pol.	High Flex Leder	7S5FH083510799D12
ABITIG® 20F Little	4 m	ED	ZA 9-pol.	High Flex Leder	7L5FH043510799D12
	8 m	ED	ZA 9-pol.	High Flex Leder	7L5FH083510799D12

Technische Änderungen vorbehalten • Verkaufspreise = unverbindliche Preisempfehlung - Angebot freibleibend • © Copyright

ABITIG® GRIP / ABITIG® GRIP Little-Brennerpreisliste

passend für WIG-Stromquellen des Fabrikates „migatronic“

Brennertyp	Länge	Schalterfunktion	maschinenseitiger Anschluss	Schlauchpaketausführung	Bestellnummer
ABITIG® 12-1	4 m	ED	ZA 9-pol.	Standard	7S6SK043510799D12
	8 m	ED	ZA 9-pol.	Standard	7S6SK083510799D12
	4 m	ED	ZA 9-pol.	High Flex Leder	7S6SH043510799D12
	8 m	ED	ZA 9-pol.	High Flex Leder	7S6SH083510799D12
ABITIG® 18SC	4 m	ED	ZA 9-pol.	Standard	7S7SK043510799D12
	8 m	ED	ZA 9-pol.	Standard	7S7SK083510799D12
	4 m	ED	ZA 9-pol.	High Flex Leder	7S7SH043510799D12
	8 m	ED	ZA 9-pol.	High Flex Leder	7S7SH083510799D12
ABITIG® 24W	4 m	ED	ZA 9-pol.	Standard	7S9SK043510799D12
	8 m	ED	ZA 9-pol.	Standard	7S9SK083510799D12
	4 m	ED	ZA 9-pol.	High Flex Leder	7S9SH043510799D12
	8 m	ED	ZA 9-pol.	High Flex Leder	7S9SH083510799D12
ABITIG® 24W Little	4 m	ED	ZA 9-pol.	High Flex Leder	7L9SH043510799D12
	8 m	ED	ZA 9-pol.	High Flex Leder	7L9SH083510799D12
ABITIG® 450W	4 m	ED	ZA 9-pol.	Standard	7T5SK043510799D12
	8 m	ED	ZA 9-pol.	Standard	7T5SK083510799D12
	4 m	ED	ZA 9-pol.	High Flex Leder	7T5SH043510799D12
	8 m	ED	ZA 9-pol.	High Flex Leder	7T5SH083510799D12
ABITIG® 260W	4 m	ED	ZA 9-pol.	Standard	7T7SK043510799D12
	8 m	ED	ZA 9-pol.	Standard	7T7SK083510799D12
	4 m	ED	ZA 9-pol.	High Flex Leder	7T7SH043510799D12
	8 m	ED	ZA 9-pol.	High Flex Leder	7T7SH083510799D12
ABITIG® 260W Little	4 m	ED	ZA 9-pol.	High Flex Leder	7L7SH043510799D12
	8 m	ED	ZA 9-pol.	High Flex Leder	7L7SH083510799D12
ABITIG® 450W SC	4 m	ED	ZA 9-pol.	Standard	
	8 m	ED	ZA 9-pol.	Standard	
	4 m	ED	ZA 9-pol.	High Flex Leder	7T8SH043510799D12
	8 m	ED	ZA 9-pol.	High Flex Leder	7T8SH083510799D12

ABITIG® GRIP / ABITIG® GRIP Little-Brennerpreisliste

passend für WIG-Stromquellen des Fabrikates „migatronic“



Brennertyp	Länge	Schalterfunktion	maschinenseitiger Anschluss	Schlauchpaketausführung	Bestellnummer
ABITIG® 18	4 m	EDP	ZA 9-pol.	Standard	7S4SK043590799D12
	8 m	EDP	ZA 9-pol.	Standard	7S4SK083590799D12
	4 m	EDP	ZA 9-pol.	High Flex Leder	7S4SH043590799D12
	8 m	EDP	ZA 9-pol.	High Flex Leder	7S4SH083590799D12
ABITIG® 18F	4 m	EDP	ZA 9-pol.	Standard	7S4FK043590799D12
	8 m	EDP	ZA 9-pol.	Standard	7S4FK083590799D12
	4 m	EDP	ZA 9-pol.	High Flex Leder	7S4FH043590799D12
	8 m	EDP	ZA 9-pol.	High Flex Leder	7S4FH083590799D12
ABITIG® 20	4 m	EDP	ZA 9-pol.	Standard	7S5SK043590799D12
	8 m	EDP	ZA 9-pol.	Standard	7S5SK083590799D12
	4 m	EDP	ZA 9-pol.	High Flex Leder	7S5SH043590799D12
	8 m	EDP	ZA 9-pol.	High Flex Leder	7S5SH083590799D12
ABITIG® 20F	4 m	EDP	ZA 9-pol.	Standard	7S5FK043590799D12
	8 m	EDP	ZA 9-pol.	Standard	7S5FK083590799D12
	4 m	EDP	ZA 9-pol.	High Flex Leder	7S5FH043590799D12
	8 m	EDP	ZA 9-pol.	High Flex Leder	7S5FH083590799D12

Technische Änderungen vorbehalten • Verkaufspreise = unverbindliche Preisempfehlung - Angebot freibleibend • © Copyright

ABITIG® GRIP / ABITIG® GRIP Little-Brennerpreisliste

passend für WIG-Stromquellen des Fabrikates „migatronik“

Brennertyp	Länge	Schalterfunktion	maschinenseitiger Anschluss	Schlauchpaketausführung	Bestellnummer
ABITIG® 12-1	4 m	EDP	ZA 9-pol.	Standard	7S6SK043590799D12
	8 m	EDP	ZA 9-pol.	Standard	7S6SK083590799D12
	4 m	EDP	ZA 9-pol.	High Flex Leder	7S6SH043590799D12
	8 m	EDP	ZA 9-pol.	High Flex Leder	7S6SH083590799D12
ABITIG® 18SC	4 m	EDP	ZA 9-pol.	Standard	7S7SK043590799D12
	8 m	EDP	ZA 9-pol.	Standard	7S7SK083590799D12
	4 m	EDP	ZA 9-pol.	High Flex Leder	7S7SH043590799D12
	8 m	EDP	ZA 9-pol.	High Flex Leder	7S7SH083590799D12
ABITIG® 24W	4 m	EDP	ZA 9-pol.	Standard	7S9SK043590799D12
	8 m	EDP	ZA 9-pol.	Standard	7S9SK083590799D12
	4 m	EDP	ZA 9-pol.	High Flex Leder	7S9SH043590799D12
	8 m	EDP	ZA 9-pol.	High Flex Leder	7S9SH083590799D12
ABITIG® 450W	4 m	EDP	ZA 9-pol.	Standard	7T5SK043590799D12
	8 m	EDP	ZA 9-pol.	Standard	7T5SK083590799D12
	4 m	EDP	ZA 9-pol.	High Flex Leder	7T5SH043590799D12
	8 m	EDP	ZA 9-pol.	High Flex Leder	7T5SH083590799D12
ABITIG® 260W	4 m	EDP	ZA 9-pol.	Standard	7T7SK043590799D12
	8 m	EDP	ZA 9-pol.	Standard	7T7SK083590799D12
	4 m	EDP	ZA 9-pol.	High Flex Leder	7T7SH043590799D12
	8 m	EDP	ZA 9-pol.	High Flex Leder	7T7SH083590799D12
ABITIG® 450W SC	4 m	EDP	ZA 9-pol.	Standard	
	8 m	EDP	ZA 9-pol.	Standard	
	4 m	EDP	ZA 9-pol.	High Flex Leder	7T8SH043590799D12
	8 m	EDP	ZA 9-pol.	High Flex Leder	7T8SH083590799D12

ABITIG® GRIP / ABITIG® GRIP Little-Brennerpreisliste

passend für WIG-Stromquellen des Fabrikates „migomat“



Brennertyp	Länge	Schalterfunktion	maschinenseitiger Anschluss	Schlauchpaketausführung	Bestellnummer
ABITIG® 9	4 m	ED/DD	ZA - GZ Tuchel 5-pol.	Standard	7S1SK043520302A00
	8 m	ED/DD	ZA - GZ Tuchel 5-pol.	Standard	7S1SK083520302A00
	4 m	ED/DD	ZA - GZ Tuchel 5-pol.	High Flex Leder	7S1SH043520302A00
	8 m	ED/DD	ZA - GZ Tuchel 5-pol.	High Flex Leder	7S1SH083520302A00
ABITIG® 9 Little	4 m	ED/DD	ZA - GZ Tuchel 5-pol.	High Flex Leder	7L1SH043520302A00
	8 m	ED/DD	ZA - GZ Tuchel 5-pol.	High Flex Leder	7L1SH083520302A00
ABITIG® 9F	4 m	ED/DD	ZA - GZ Tuchel 5-pol.	Standard	7S1FK043520302A00
	8 m	ED/DD	ZA - GZ Tuchel 5-pol.	Standard	7S1FK083520302A00
	4 m	ED/DD	ZA - GZ Tuchel 5-pol.	High Flex Leder	7S1FH043520302A00
	8 m	ED/DD	ZA - GZ Tuchel 5-pol.	High Flex Leder	7S1FH083520302A00
ABITIG® 9F Little	4 m	ED/DD	ZA - GZ Tuchel 5-pol.	High Flex Leder	7L1FH043520302A00
	8 m	ED/DD	ZA - GZ Tuchel 5-pol.	High Flex Leder	7L1FH083520302A00
ABITIG® 17	4 m	ED/DD	ZA - GZ Tuchel 5-pol.	Standard	7S2SK043520302A00
	8 m	ED/DD	ZA - GZ Tuchel 5-pol.	Standard	7S2SK083520302A00
	4 m	ED/DD	ZA - GZ Tuchel 5-pol.	High Flex Leder	7S2SH043520302A00
	8 m	ED/DD	ZA - GZ Tuchel 5-pol.	High Flex Leder	7S2SH083520302A00
ABITIG® 17 Little	4 m	ED/DD	ZA - GZ Tuchel 5-pol.	High Flex Leder	7L2SH043520302A00
	8 m	ED/DD	ZA - GZ Tuchel 5-pol.	High Flex Leder	7L2SH083520302A00
ABITIG® 17F	4 m	ED/DD	ZA - GZ Tuchel 5-pol.	Standard	7S2FK043520302A00
	8 m	ED/DD	ZA - GZ Tuchel 5-pol.	Standard	7S2FK083520302A00
	4 m	ED/DD	ZA - GZ Tuchel 5-pol.	High Flex Leder	7S2FH043520302A00
	8 m	ED/DD	ZA - GZ Tuchel 5-pol.	High Flex Leder	7S2FH083520302A00
ABITIG® 17F Little	4 m	ED/DD	ZA - GZ Tuchel 5-pol.	High Flex Leder	7L2FH043520302A00
	8 m	ED/DD	ZA - GZ Tuchel 5-pol.	High Flex Leder	7L2FH083520302A00

Technische Änderungen vorbehalten • Verkaufspreise = unverbindliche Preisempfehlung - Angebot freibleibend • © Copyright

ABITIG® GRIP / ABITIG® GRIP Little-Brennerpreisliste

passend für WIG-Stromquellen des Fabrikates „migomat“

Brennertyp	Länge	Schalterfunktion	maschinenseitiger Anschluss	Schlauchpaketausführung	Bestellnummer
ABITIG® 26	4 m	ED/DD	ZA - GZ Tuchel 5-pol.	Standard	7S3SK043520302A00
	8 m	ED/DD	ZA - GZ Tuchel 5-pol.	Standard	7S3SK083520302A00
	4 m	ED/DD	ZA - GZ Tuchel 5-pol.	High Flex Leder	7S3SH043520302A00
	8 m	ED/DD	ZA - GZ Tuchel 5-pol.	High Flex Leder	7S3SH083520302A00
ABITIG® 26F	4 m	ED/DD	ZA - GZ Tuchel 5-pol.	Standard	7S3FK043520302A00
	8 m	ED/DD	ZA - GZ Tuchel 5-pol.	Standard	7S3FK083520302A00
	4 m	ED/DD	ZA - GZ Tuchel 5-pol.	High Flex Leder	7S3FH043520302A00
	8 m	ED/DD	ZA - GZ Tuchel 5-pol.	High Flex Leder	7S3FH083520302A00
ABITIG® 24G	4 m	ED/DD	ZA - GZ Tuchel 5-pol.	Standard	7S8SK043520302A00
	8 m	ED/DD	ZA - GZ Tuchel 5-pol.	Standard	7S8SK083520302A00
	4 m	ED/DD	ZA - GZ Tuchel 5-pol.	High Flex Leder	7S8SH043520302A00
	8 m	ED/DD	ZA - GZ Tuchel 5-pol.	High Flex Leder	7S8SH083520302A00
ABITIG® 24G Little	4 m	ED/DD	ZA - GZ Tuchel 5-pol.	High Flex Leder	7L8SH043520302A00
	8 m	ED/DD	ZA - GZ Tuchel 5-pol.	High Flex Leder	7L8SH083520302A00
ABITIG® 200	4 m	ED/DD	ZA - GZ Tuchel 5-pol.	Standard	7T4SK043520302A00
	8 m	ED/DD	ZA - GZ Tuchel 5-pol.	Standard	7T4SK083520302A00
	4 m	ED/DD	ZA - GZ Tuchel 5-pol.	High Flex Leder	7T4SH043520302A00
	8 m	ED/DD	ZA - GZ Tuchel 5-pol.	High Flex Leder	7T4SH083520302A00
ABITIG® 200F	4 m	ED/DD	ZA - GZ Tuchel 5-pol.	Standard	7T4FK043520302A00
	8 m	ED/DD	ZA - GZ Tuchel 5-pol.	Standard	7T4FK083520302A00
	4 m	ED/DD	ZA - GZ Tuchel 5-pol.	High Flex Leder	7T4FH043520302A00
	8 m	ED/DD	ZA - GZ Tuchel 5-pol.	High Flex Leder	7T4FH083520302A00
ABITIG® 150	4 m	ED/DD	ZA - GZ Tuchel 5-pol.	Standard	7T6SK043520302A00
	8 m	ED/DD	ZA - GZ Tuchel 5-pol.	Standard	7T6SK083520302A00
	4 m	ED/DD	ZA - GZ Tuchel 5-pol.	High Flex Leder	7T6SH043520302A00
	8 m	ED/DD	ZA - GZ Tuchel 5-pol.	High Flex Leder	7T6SH083520302A00
ABITIG® 150 Little	4 m	ED/DD	ZA - GZ Tuchel 5-pol.	High Flex Leder	7L6SH043520302A00
	8 m	ED/DD	ZA - GZ Tuchel 5-pol.	High Flex Leder	7L6SH083520302A00
ABITIG® 150F	4 m	ED/DD	ZA - GZ Tuchel 5-pol.	Standard	7T6FK043520302A00
	8 m	ED/DD	ZA - GZ Tuchel 5-pol.	Standard	7T6FK083520302A00
	4 m	ED/DD	ZA - GZ Tuchel 5-pol.	High Flex Leder	7T6FH043520302A00
	8 m	ED/DD	ZA - GZ Tuchel 5-pol.	High Flex Leder	7T6FH083520302A00
ABITIG® 150F Little	4 m	ED/DD	ZA - GZ Tuchel 5-pol.	High Flex Leder	7L6FH043520302A00
	8 m	ED/DD	ZA - GZ Tuchel 5-pol.	High Flex Leder	7L6FH083520302A00

ABITIG® GRIP / ABITIG® GRIP Little-Brennerpreisliste

passend für WIG-Stromquellen des Fabrikates „migomat“



Brennertyp	Länge	Schalterfunktion	maschinenseitiger Anschluss	Schlauchpaketausführung	Bestellnummer
ABITIG® 18	4 m	ED/DD	ZA - WZ-0 Tuchel 5-pol.	Standard	7S4SK043520302A12
	8 m	ED/DD	ZA - WZ-0 Tuchel 5-pol.	Standard	7S4SK083520302A12
	4 m	ED/DD	ZA - WZ-0 Tuchel 5-pol.	High Flex Leder	7S4SH043520302A12
	8 m	ED/DD	ZA - WZ-0 Tuchel 5-pol.	High Flex Leder	7S4SH083520302A12
ABITIG® 18F	4 m	ED/DD	ZA - WZ-0 Tuchel 5-pol.	Standard	7S4FK043520302A12
	8 m	ED/DD	ZA - WZ-0 Tuchel 5-pol.	Standard	7S4FK083520302A12
	4 m	ED/DD	ZA - WZ-0 Tuchel 5-pol.	High Flex Leder	7S4FH043520302A12
	8 m	ED/DD	ZA - WZ-0 Tuchel 5-pol.	High Flex Leder	7S4FH083520302A12
ABITIG® 20	4 m	ED/DD	ZA - WZ-0 Tuchel 5-pol.	Standard	7S5SK043520302A12
	8 m	ED/DD	ZA - WZ-0 Tuchel 5-pol.	Standard	7S5SK083520302A12
	4 m	ED/DD	ZA - WZ-0 Tuchel 5-pol.	High Flex Leder	7S5SH043520302A12
	8 m	ED/DD	ZA - WZ-0 Tuchel 5-pol.	High Flex Leder	7S5SH083520302A12
ABITIG® 20 Little	4 m	ED/DD	ZA - WZ-0 Tuchel 5-pol.	High Flex Leder	7L5SH043520302A12
	8 m	ED/DD	ZA - WZ-0 Tuchel 5-pol.	High Flex Leder	7L5SH083520302A12
ABITIG® 20F	4 m	ED/DD	ZA - WZ-0 Tuchel 5-pol.	Standard	7S5FK043520302A12
	8 m	ED/DD	ZA - WZ-0 Tuchel 5-pol.	Standard	7S5FK083520302A12
	4 m	ED/DD	ZA - WZ-0 Tuchel 5-pol.	High Flex Leder	7S5FH043520302A12
	8 m	ED/DD	ZA - WZ-0 Tuchel 5-pol.	High Flex Leder	7S5FH083520302A12
ABITIG® 20F Little	4 m	ED/DD	ZA - WZ-0 Tuchel 5-pol.	High Flex Leder	7L5FH043520302A12
	8 m	ED/DD	ZA - WZ-0 Tuchel 5-pol.	High Flex Leder	7L5FH083520302A12

Technische Änderungen vorbehalten • Verkaufspreise = unverbindliche Preisempfehlung - Angebot freibleibend • © Copyright

ABITIG® GRIP / ABITIG® GRIP Little-Brennerpreisliste

passend für WIG-Stromquellen des Fabrikates „migomat“

Brennertyp	Länge	Schalterfunktion	maschinenseitiger Anschluss	Schlauchpaketausführung	Bestellnummer
ABITIG® 12-1	4 m	ED/DD	ZA - WZ-0 Tuchel 5-pol.	Standard	7S6SK043520302A12
	8 m	ED/DD	ZA - WZ-0 Tuchel 5-pol.	Standard	7S6SK083520302A12
	4 m	ED/DD	ZA - WZ-0 Tuchel 5-pol.	High Flex Leder	7S6SH043520302A12
	8 m	ED/DD	ZA - WZ-0 Tuchel 5-pol.	High Flex Leder	7S6SH083520302A12
ABITIG® 18SC	4 m	ED/DD	ZA - WZ-0 Tuchel 5-pol.	Standard	7S7SK043520302A12
	8 m	ED/DD	ZA - WZ-0 Tuchel 5-pol.	Standard	7S7SK083520302A12
	4 m	ED/DD	ZA - WZ-0 Tuchel 5-pol.	High Flex Leder	7S7SH043520302A12
	8 m	ED/DD	ZA - WZ-0 Tuchel 5-pol.	High Flex Leder	7S7SH083520302A12
ABITIG® 24W	4 m	ED/DD	ZA - WZ-0 Tuchel 5-pol.	Standard	7S9SK043520302A12
	8 m	ED/DD	ZA - WZ-0 Tuchel 5-pol.	Standard	7S9SK083520302A12
	4 m	ED/DD	ZA - WZ-0 Tuchel 5-pol.	High Flex Leder	7S9SH043520302A12
	8 m	ED/DD	ZA - WZ-0 Tuchel 5-pol.	High Flex Leder	7S9SH083520302A12
ABITIG® 24W Little	4 m	ED/DD	ZA - WZ-0 Tuchel 5-pol.	High Flex Leder	7L9SH043520302A12
	8 m	ED/DD	ZA - WZ-0 Tuchel 5-pol.	High Flex Leder	7L9SH083520302A12
ABITIG® 450W	4 m	ED/DD	ZA - WZ-0 Tuchel 5-pol.	Standard	7T5SK043520302A12
	8 m	ED/DD	ZA - WZ-0 Tuchel 5-pol.	Standard	7T5SK083520302A12
	4 m	ED/DD	ZA - WZ-0 Tuchel 5-pol.	High Flex Leder	7T5SH043520302A12
	8 m	ED/DD	ZA - WZ-0 Tuchel 5-pol.	High Flex Leder	7T5SH083520302A12
ABITIG® 260W	4 m	ED/DD	ZA - WZ-0 Tuchel 5-pol.	Standard	7T7SK043520302A12
	8 m	ED/DD	ZA - WZ-0 Tuchel 5-pol.	Standard	7T7SK083520302A12
	4 m	ED/DD	ZA - WZ-0 Tuchel 5-pol.	High Flex Leder	7T7SH043520302A12
	8 m	ED/DD	ZA - WZ-0 Tuchel 5-pol.	High Flex Leder	7T7SH083520302A12
ABITIG® 260W Little	4 m	ED/DD	ZA - WZ-0 Tuchel 5-pol.	High Flex Leder	7L7SH043520302A12
	8 m	ED/DD	ZA - WZ-0 Tuchel 5-pol.	High Flex Leder	7L7SH083520302A12
ABITIG® 450W SC	4 m	ED/DD	ZA - WZ-0 Tuchel 5-pol.	Standard	
	8 m	ED/DD	ZA - WZ-0 Tuchel 5-pol.	Standard	
	4 m	ED/DD	ZA - WZ-0 Tuchel 5-pol.	High Flex Leder	7T8SH043520302A12
	8 m	ED/DD	ZA - WZ-0 Tuchel 5-pol.	High Flex Leder	7T8SH083520302A12

ABITIG® GRIP / ABITIG® GRIP Little-Brennerpreisliste

passend für WIG-Stromquellen des Fabrikates „nimak“



Brennertyp	Länge	Schalterfunktion	maschinenseitiger Anschluss	Schlauchpaketausführung	Bestellnummer
ABITIG® 9	4 m	ED/DD	BSB 35-50 Tuchel 5-pol.	Standard	7S1SK043520001A06
	8 m	ED/DD	BSB 35-50 Tuchel 5-pol.	Standard	7S1SK083520001A06
	4 m	ED/DD	BSB 35-50 Tuchel 5-pol.	High Flex Leder	7S1SH043520001A06
	8 m	ED/DD	BSB 35-50 Tuchel 5-pol.	High Flex Leder	7S1SH083520001A06
ABITIG® 9 Little	4 m	ED/DD	BSB 35-50 Tuchel 5-pol.	High Flex Leder	7L1SH043520001A06
	8 m	ED/DD	BSB 35-50 Tuchel 5-pol.	High Flex Leder	7L1SH083520001A06
ABITIG® 9F	4 m	ED/DD	BSB 35-50 Tuchel 5-pol.	Standard	7S1FK043520001A06
	8 m	ED/DD	BSB 35-50 Tuchel 5-pol.	Standard	7S1FK083520001A06
	4 m	ED/DD	BSB 35-50 Tuchel 5-pol.	High Flex Leder	7S1FH043520001A06
	8 m	ED/DD	BSB 35-50 Tuchel 5-pol.	High Flex Leder	7S1FH083520001A06
ABITIG® 9F Little	4 m	ED/DD	BSB 35-50 Tuchel 5-pol.	High Flex Leder	7L1FH043520001A06
	8 m	ED/DD	BSB 35-50 Tuchel 5-pol.	High Flex Leder	7L1FH083520001A06
ABITIG® 17	4 m	ED/DD	BSB 35-50 Tuchel 5-pol.	Standard	7S2SK043520001A06
	8 m	ED/DD	BSB 35-50 Tuchel 5-pol.	Standard	7S2SK083520001A06
	4 m	ED/DD	BSB 35-50 Tuchel 5-pol.	High Flex Leder	7S2SH043520001A06
	8 m	ED/DD	BSB 35-50 Tuchel 5-pol.	High Flex Leder	7S2SH083520001A06
ABITIG® 17 Little	4 m	ED/DD	BSB 35-50 Tuchel 5-pol.	High Flex Leder	7L2SH043520001A06
	8 m	ED/DD	BSB 35-50 Tuchel 5-pol.	High Flex Leder	7L2SH083520001A06
ABITIG® 17F	4 m	ED/DD	BSB 35-50 Tuchel 5-pol.	Standard	7S2FK043520001A06
	8 m	ED/DD	BSB 35-50 Tuchel 5-pol.	Standard	7S2FK083520001A06
	4 m	ED/DD	BSB 35-50 Tuchel 5-pol.	High Flex Leder	7S2FH043520001A06
	8 m	ED/DD	BSB 35-50 Tuchel 5-pol.	High Flex Leder	7S2FH083520001A06
ABITIG® 17F Little	4 m	ED/DD	BSB 35-50 Tuchel 5-pol.	High Flex Leder	7L2FH043520001A06
	8 m	ED/DD	BSB 35-50 Tuchel 5-pol.	High Flex Leder	7L2FH083520001A06

Technische Änderungen vorbehalten • Verkaufspreise = unverbindliche Preisempfehlung - Angebot freibleibend • © Copyright

ABITIG® GRIP / ABITIG® GRIP Little-Brennerpreisliste

passend für WIG-Stromquellen des Fabrikates „nimak“

Brennertyp	Länge	Schalterfunktion	maschinenseitiger Anschluss	Schlauchpaketausführung	Bestellnummer
ABITIG® 26	4 m	ED/DD	BSB 35-50 Tuchel 5-pol.	Standard	7S3SK043520001A06
	8 m	ED/DD	BSB 35-50 Tuchel 5-pol.	Standard	7S3SK083520001A06
	4 m	ED/DD	BSB 35-50 Tuchel 5-pol.	High Flex Leder	7S3SH043520001A06
	8 m	ED/DD	BSB 35-50 Tuchel 5-pol.	High Flex Leder	7S3SH083520001A06
ABITIG® 26F	4 m	ED/DD	BSB 35-50 Tuchel 5-pol.	Standard	7S3FK043520001A06
	8 m	ED/DD	BSB 35-50 Tuchel 5-pol.	Standard	7S3FK083520001A06
	4 m	ED/DD	BSB 35-50 Tuchel 5-pol.	High Flex Leder	7S3FH043520001A06
	8 m	ED/DD	BSB 35-50 Tuchel 5-pol.	High Flex Leder	7S3FH083520001A06
ABITIG® 24G	4 m	ED/DD	BSB 35-50 Tuchel 5-pol.	Standard	7S8SK043520001A06
	8 m	ED/DD	BSB 35-50 Tuchel 5-pol.	Standard	7S8SK083520001A06
	4 m	ED/DD	BSB 35-50 Tuchel 5-pol.	High Flex Leder	7S8SH043520001A06
	8 m	ED/DD	BSB 35-50 Tuchel 5-pol.	High Flex Leder	7S8SH083520001A06
ABITIG® 24G Little	4 m	ED/DD	BSB 35-50 Tuchel 5-pol.	High Flex Leder	7L8SH043520001A06
	8 m	ED/DD	BSB 35-50 Tuchel 5-pol.	High Flex Leder	7L8SH083520001A06
ABITIG® 200	4 m	ED/DD	BSB 35-50 Tuchel 5-pol.	Standard	7T4SK043520001A06
	8 m	ED/DD	BSB 35-50 Tuchel 5-pol.	Standard	7T4SK083520001A06
	4 m	ED/DD	BSB 35-50 Tuchel 5-pol.	High Flex Leder	7T4SH043520001A06
	8 m	ED/DD	BSB 35-50 Tuchel 5-pol.	High Flex Leder	7T4SH083520001A06
ABITIG® 200F	4 m	ED/DD	BSB 35-50 Tuchel 5-pol.	Standard	7T4FK043520001A06
	8 m	ED/DD	BSB 35-50 Tuchel 5-pol.	Standard	7T4FK083520001A06
	4 m	ED/DD	BSB 35-50 Tuchel 5-pol.	High Flex Leder	7T4FH043520001A06
	8 m	ED/DD	BSB 35-50 Tuchel 5-pol.	High Flex Leder	7T4FH083520001A06
ABITIG® 150	4 m	ED/DD	BSB 35-50 Tuchel 5-pol.	Standard	7T6SK043520001A06
	8 m	ED/DD	BSB 35-50 Tuchel 5-pol.	Standard	7T6SK083520001A06
	4 m	ED/DD	BSB 35-50 Tuchel 5-pol.	High Flex Leder	7T6SH043520001A06
	8 m	ED/DD	BSB 35-50 Tuchel 5-pol.	High Flex Leder	7T6SH083520001A06
ABITIG® 150 Little	4 m	ED/DD	BSB 35-50 Tuchel 5-pol.	High Flex Leder	7L6SH043520001A06
	8 m	ED/DD	BSB 35-50 Tuchel 5-pol.	High Flex Leder	7L6SH083520001A06
ABITIG® 150F	4 m	ED/DD	BSB 35-50 Tuchel 5-pol.	Standard	7T6FK043520001A06
	8 m	ED/DD	BSB 35-50 Tuchel 5-pol.	Standard	7T6FK083520001A06
	4 m	ED/DD	BSB 35-50 Tuchel 5-pol.	High Flex Leder	7T6FH043520001A06
	8 m	ED/DD	BSB 35-50 Tuchel 5-pol.	High Flex Leder	7T6FH083520001A06
ABITIG® 150F Little	4 m	ED/DD	BSB 35-50 Tuchel 5-pol.	High Flex Leder	7L6FH043520001A06
	8 m	ED/DD	BSB 35-50 Tuchel 5-pol.	High Flex Leder	7L6FH083520001A06

ABITIG® GRIP / ABITIG® GRIP Little-Brennerpreisliste

passend für WIG-Stromquellen des Fabrikates „nimak“



Brennertyp	Länge	Schalterfunktion	maschinenseitiger Anschluss	Schlauchpaketausführung	Bestellnummer
ABITIG® 9	4 m	ED/DD	ZA - WTG-5	Standard	7S1SK043520498A00
	8 m	ED/DD	ZA - WTG-5	Standard	7S1SK083520498A00
	4 m	ED/DD	ZA - WTG-5	High Flex Leder	7S1SH043520498A00
	8 m	ED/DD	ZA - WTG-5	High Flex Leder	7S1SH083520498A00
ABITIG® 9 Little	4 m	ED/DD	ZA - WTG-5	High Flex Leder	7L1SH043520498A00
	8 m	ED/DD	ZA - WTG-5	High Flex Leder	7L1SH083520498A00
ABITIG® 9F	4 m	ED/DD	ZA - WTG-5	Standard	7S1FK043520498A00
	8 m	ED/DD	ZA - WTG-5	Standard	7S1FK083520498A00
	4 m	ED/DD	ZA - WTG-5	High Flex Leder	7S1FH043520498A00
	8 m	ED/DD	ZA - WTG-5	High Flex Leder	7S1FH083520498A00
ABITIG® 9F Little	4 m	ED/DD	ZA - WTG-5	High Flex Leder	7L1FH043520498A00
	8 m	ED/DD	ZA - WTG-5	High Flex Leder	7L1FH083520498A00
ABITIG® 17	4 m	ED/DD	ZA - WTG-5	Standard	7S2SK043520498A00
	8 m	ED/DD	ZA - WTG-5	Standard	7S2SK083520498A00
	4 m	ED/DD	ZA - WTG-5	High Flex Leder	7S2SH043520498A00
	8 m	ED/DD	ZA - WTG-5	High Flex Leder	7S2SH083520498A00
ABITIG® 17 Little	4 m	ED/DD	ZA - WTG-5	High Flex Leder	7L2SH043520498A00
	8 m	ED/DD	ZA - WTG-5	High Flex Leder	7L2SH083520498A00
ABITIG® 17F	4 m	ED/DD	ZA - WTG-5	Standard	7S2FK043520498A00
	8 m	ED/DD	ZA - WTG-5	Standard	7S2FK083520498A00
	4 m	ED/DD	ZA - WTG-5	High Flex Leder	7S2FH043520498A00
	8 m	ED/DD	ZA - WTG-5	High Flex Leder	7S2FH083520498A00
ABITIG® 17F Little	4 m	ED/DD	ZA - WTG-5	High Flex Leder	7L2FH043520498A00
	8 m	ED/DD	ZA - WTG-5	High Flex Leder	7L2FH083520498A00

Technische Änderungen vorbehalten • Verkaufspreise = unverbindliche Preisempfehlung - Angebot freibleibend • © Copyright

ABITIG® GRIP / ABITIG® GRIP Little-Brennerpreisliste

passend für WIG-Stromquellen des Fabrikates „nimak“

Brennertyp	Länge	Schalterfunktion	maschinenseitiger Anschluss	Schlauchpaketausführung	Bestellnummer
ABITIG® 26	4 m	ED/DD	ZA - WTG-5	Standard	7S3SK043520498A00
	8 m	ED/DD	ZA - WTG-5	Standard	7S3SK083520498A00
	4 m	ED/DD	ZA - WTG-5	High Flex Leder	7S3SH043520498A00
	8 m	ED/DD	ZA - WTG-5	High Flex Leder	7S3SH083520498A00
ABITIG® 26F	4 m	ED/DD	ZA - WTG-5	Standard	7S3FK043520498A00
	8 m	ED/DD	ZA - WTG-5	Standard	7S3FK083520498A00
	4 m	ED/DD	ZA - WTG-5	High Flex Leder	7S3FH043520498A00
	8 m	ED/DD	ZA - WTG-5	High Flex Leder	7S3FH083520498A00
ABITIG® 24G	4 m	ED/DD	ZA - WTG-5	Standard	7S8SK043520498A00
	8 m	ED/DD	ZA - WTG-5	Standard	7S8SK083520498A00
	4 m	ED/DD	ZA - WTG-5	High Flex Leder	7S8SH043520498A00
	8 m	ED/DD	ZA - WTG-5	High Flex Leder	7S8SH083520498A00
ABITIG® 24G Little	4 m	ED/DD	ZA - WTG-5	High Flex Leder	7L8SH043520498A00
	8 m	ED/DD	ZA - WTG-5	High Flex Leder	7L8SH083520498A00
ABITIG® 200	4 m	ED/DD	ZA - WTG-5	Standard	7T4SK043520498A00
	8 m	ED/DD	ZA - WTG-5	Standard	7T4SK083520498A00
	4 m	ED/DD	ZA - WTG-5	High Flex Leder	7T4SH043520498A00
	8 m	ED/DD	ZA - WTG-5	High Flex Leder	7T4SH083520498A00
ABITIG® 200F	4 m	ED/DD	ZA - WTG-5	Standard	7T4FK043520498A00
	8 m	ED/DD	ZA - WTG-5	Standard	7T4FK083520498A00
	4 m	ED/DD	ZA - WTG-5	High Flex Leder	7T4FH043520498A00
	8 m	ED/DD	ZA - WTG-5	High Flex Leder	7T4FH083520498A00
ABITIG® 150	4 m	ED/DD	ZA - WTG-5	Standard	7T6SK043520498A00
	8 m	ED/DD	ZA - WTG-5	Standard	7T6SK083520498A00
	4 m	ED/DD	ZA - WTG-5	High Flex Leder	7T6SH043520498A00
	8 m	ED/DD	ZA - WTG-5	High Flex Leder	7T6SH083520498A00
ABITIG® 150 Little	4 m	ED/DD	ZA - WTG-5	High Flex Leder	7L6SH043520498A00
	8 m	ED/DD	ZA - WTG-5	High Flex Leder	7L6SH083520498A00
ABITIG® 150F	4 m	ED/DD	ZA - WTG-5	Standard	7T6FK043520498A00
	8 m	ED/DD	ZA - WTG-5	Standard	7T6FK083520498A00
	4 m	ED/DD	ZA - WTG-5	High Flex Leder	7T6FH043520498A00
	8 m	ED/DD	ZA - WTG-5	High Flex Leder	7T6FH083520498A00
ABITIG® 150F Little	4 m	ED/DD	ZA - WTG-5	High Flex Leder	7L6FH043520498A00
	8 m	ED/DD	ZA - WTG-5	High Flex Leder	7L6FH083520498A00

ABITIG® GRIP / ABITIG® GRIP Little-Brennerpreisliste

passend für WIG-Stromquellen des Fabrikates „nimak“

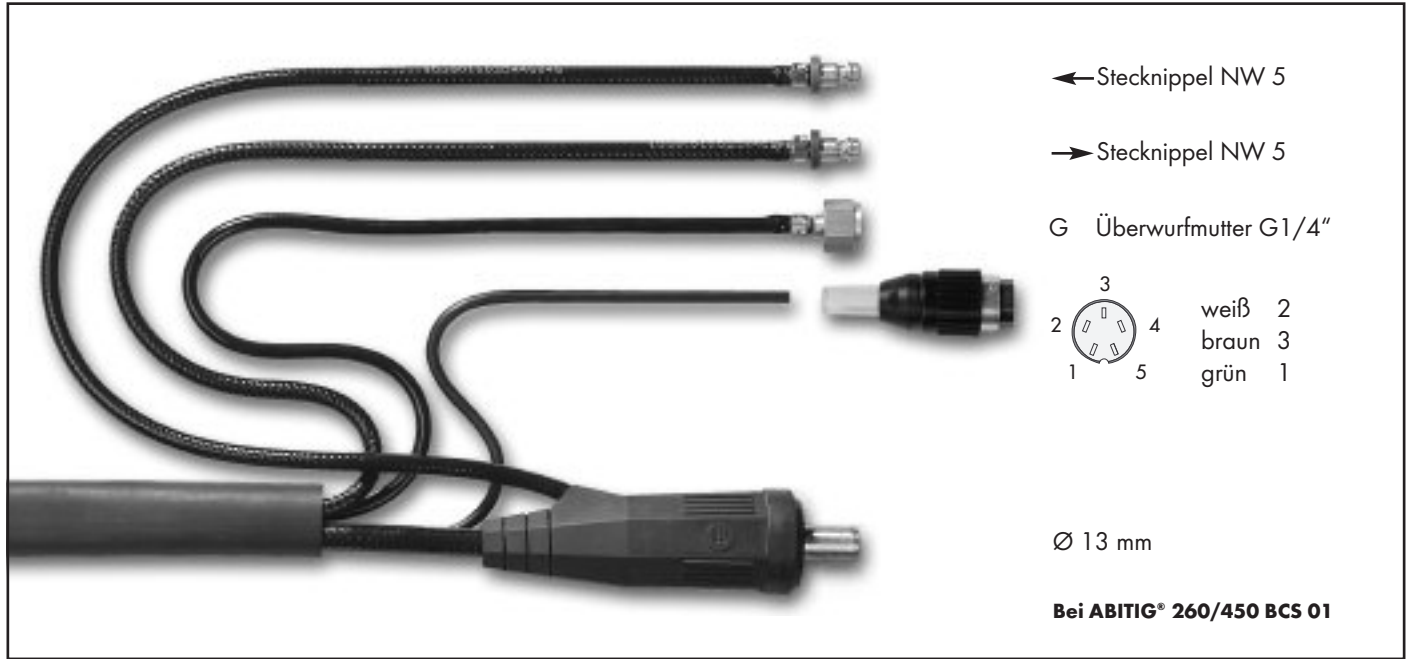

Brennertyp	Länge	Schalterfunktion	maschinenseitiger Anschluss	Schlauchpaketausführung	Bestellnummer
ABITIG® 18	4 m	ED/DD	BSB 35-50 Tuchel 5-pol.	Standard	7S4SK043520001A11
	8 m	ED/DD	BSB 35-50 Tuchel 5-pol.	Standard	7S4SK083520001A11
	4 m	ED/DD	BSB 35-50 Tuchel 5-pol.	High Flex Leder	7S4SH043520001A11
	8 m	ED/DD	BSB 35-50 Tuchel 5-pol.	High Flex Leder	7S4SH083520001A11
ABITIG® 18F	4 m	ED/DD	BSB 35-50 Tuchel 5-pol.	Standard	7S4FK043520001A11
	8 m	ED/DD	BSB 35-50 Tuchel 5-pol.	Standard	7S4FK083520001A11
	4 m	ED/DD	BSB 35-50 Tuchel 5-pol.	High Flex Leder	7S4FH043520001A11
	8 m	ED/DD	BSB 35-50 Tuchel 5-pol.	High Flex Leder	7S4FH083520001A11
ABITIG® 20	4 m	ED/DD	BSB 35-50 Tuchel 5-pol.	Standard	7S5SK043520001A11
	8 m	ED/DD	BSB 35-50 Tuchel 5-pol.	Standard	7S5SK083520001A11
	4 m	ED/DD	BSB 35-50 Tuchel 5-pol.	High Flex Leder	7S5SH043520001A11
	8 m	ED/DD	BSB 35-50 Tuchel 5-pol.	High Flex Leder	7S5SH083520001A11
ABITIG® 20 Little	4 m	ED/DD	BSB 35-50 Tuchel 5-pol.	High Flex Leder	7L5SH043520001A11
	8 m	ED/DD	BSB 35-50 Tuchel 5-pol.	High Flex Leder	7L5SH083520001A11
ABITIG® 20F	4 m	ED/DD	BSB 35-50 Tuchel 5-pol.	Standard	7S5FK043520001A11
	8 m	ED/DD	BSB 35-50 Tuchel 5-pol.	Standard	7S5FK083520001A11
	4 m	ED/DD	BSB 35-50 Tuchel 5-pol.	High Flex Leder	7S5FH043520001A11
	8 m	ED/DD	BSB 35-50 Tuchel 5-pol.	High Flex Leder	7S5FH083520001A11
ABITIG® 20F Little	4 m	ED/DD	BSB 35-50 Tuchel 5-pol.	High Flex Leder	7L5FH043520001A11
	8 m	ED/DD	BSB 35-50 Tuchel 5-pol.	High Flex Leder	7L5FH083520001A11

Technische Änderungen vorbehalten • Verkaufspreise = unverbindliche Preisempfehlung - Angebot freibleibend • © Copyright

ABITIG® GRIP / ABITIG® GRIP Little-Brennerpreisliste

passend für WIG-Stromquellen des Fabrikates „nimak“

Brennertyp	Länge	Schalterfunktion	maschinenseitiger Anschluss	Schlauchpaketausführung	Bestellnummer
ABITIG® 12-1	4 m	ED/DD	BSB 35-50 Tuchel 5-pol.	Standard	7S6SK043520001A11
	8 m	ED/DD	BSB 35-50 Tuchel 5-pol.	Standard	7S6SK083520001A11
	4 m	ED/DD	BSB 35-50 Tuchel 5-pol.	High Flex Leder	7S6SH043520001A11
	8 m	ED/DD	BSB 35-50 Tuchel 5-pol.	High Flex Leder	7S6SH083520001A11
ABITIG® 18SC	4 m	ED/DD	BSB 35-50 Tuchel 5-pol.	Standard	7S7SK043520001A11
	8 m	ED/DD	BSB 35-50 Tuchel 5-pol.	Standard	7S7SK083520001A11
	4 m	ED/DD	BSB 35-50 Tuchel 5-pol.	High Flex Leder	7S7SH043520001A11
	8 m	ED/DD	BSB 35-50 Tuchel 5-pol.	High Flex Leder	7S7SH083520001A11
ABITIG® 24W	4 m	ED/DD	BSB 35-50 Tuchel 5-pol.	Standard	7S9SK043520001A11
	8 m	ED/DD	BSB 35-50 Tuchel 5-pol.	Standard	7S9SK083520001A11
	4 m	ED/DD	BSB 35-50 Tuchel 5-pol.	High Flex Leder	7S9SH043520001A11
	8 m	ED/DD	BSB 35-50 Tuchel 5-pol.	High Flex Leder	7S9SH083520001A11
ABITIG® 24W Little	4 m	ED/DD	BSB 35-50 Tuchel 5-pol.	High Flex Leder	7L9SH043520001A11
	8 m	ED/DD	BSB 35-50 Tuchel 5-pol.	High Flex Leder	7L9SH083520001A11
ABITIG® 450W	4 m	ED/DD	BSB 35-50 Tuchel 5-pol.	Standard	7T5SK043520101A11
	8 m	ED/DD	BSB 35-50 Tuchel 5-pol.	Standard	7T5SK083520101A11
	4 m	ED/DD	BSB 35-50 Tuchel 5-pol.	High Flex Leder	7T5SH043520101A11
	8 m	ED/DD	BSB 35-50 Tuchel 5-pol.	High Flex Leder	7T5SH083520101A11
ABITIG® 260W	4 m	ED/DD	BSB 35-50 Tuchel 5-pol.	Standard	7T7SK043520101A11
	8 m	ED/DD	BSB 35-50 Tuchel 5-pol.	Standard	7T7SK083520101A11
	4 m	ED/DD	BSB 35-50 Tuchel 5-pol.	High Flex Leder	7T7SH043520101A11
	8 m	ED/DD	BSB 35-50 Tuchel 5-pol.	High Flex Leder	7T7SH083520101A11
ABITIG® 260W Little	4 m	ED/DD	BSB 35-50 Tuchel 5-pol.	High Flex Leder	7L7SH043520101A11
	8 m	ED/DD	BSB 35-50 Tuchel 5-pol.	High Flex Leder	7L7SH083520101A11
ABITIG® 450W SC	4 m	ED/DD	BSB 35-50 Tuchel 5-pol.	Standard	
	8 m	ED/DD	BSB 35-50 Tuchel 5-pol.	Standard	
	4 m	ED/DD	BSB 35-50 Tuchel 5-pol.	High Flex Leder	7T8SH043520101A11
	8 m	ED/DD	BSB 35-50 Tuchel 5-pol.	High Flex Leder	7T8SH083520101A11

ABITIG® GRIP / ABITIG® GRIP Little-Brennerpreisliste

passend für WIG-Stromquellen des Fabrikates „nimak“



Brennertyp	Länge	Schalterfunktion	maschinenseitiger Anschluss	Schlauchpaketausführung	Bestellnummer
ABITIG® 18	4 m	ED/DD	ZA - WTW-5	Standard	7S4SK043520498A12
	8 m	ED/DD	ZA - WTW-5	Standard	7S4SK083520498A12
	4 m	ED/DD	ZA - WTW-5	High Flex Leder	7S4SH043520498A12
	8 m	ED/DD	ZA - WTW-5	High Flex Leder	7S4SH083520498A12
ABITIG® 18F	4 m	ED/DD	ZA - WTW-5	Standard	7S4FK043520498A12
	8 m	ED/DD	ZA - WTW-5	Standard	7S4FK083520498A12
	4 m	ED/DD	ZA - WTW-5	High Flex Leder	7S4FH043520498A12
	8 m	ED/DD	ZA - WTW-5	High Flex Leder	7S4FH083520498A12
ABITIG® 20	4 m	ED/DD	ZA - WTW-5	Standard	7S5SK043520498A12
	8 m	ED/DD	ZA - WTW-5	Standard	7S5SK083520498A12
	4 m	ED/DD	ZA - WTW-5	High Flex Leder	7S5SH043520498A12
	8 m	ED/DD	ZA - WTW-5	High Flex Leder	7S5SH083520498A12
ABITIG® 20 Little	4 m	ED/DD	ZA - WTW-5	High Flex Leder	7L5SH043520498A12
	8 m	ED/DD	ZA - WTW-5	High Flex Leder	7L5SH083520498A12
ABITIG® 20F	4 m	ED/DD	ZA - WTW-5	Standard	7S5FK043520498A12
	8 m	ED/DD	ZA - WTW-5	Standard	7S5FK083520498A12
	4 m	ED/DD	ZA - WTW-5	High Flex Leder	7S5FH043520498A12
	8 m	ED/DD	ZA - WTW-5	High Flex Leder	7S5FH083520498A12
ABITIG® 20F Little	4 m	ED/DD	ZA - WTW-5	High Flex Leder	7L5FH043520498A12
	8 m	ED/DD	ZA - WTW-5	High Flex Leder	7L5FH083520498A12

Technische Änderungen vorbehalten • Verkaufspreise = unverbindliche Preisempfehlung - Angebot freibleibend • © Copyright

ABITIG® GRIP / ABITIG® GRIP Little-Brennerpreisliste

passend für WIG-Stromquellen des Fabrikates „nimak“

Brennertyp	Länge	Schalterfunktion	maschinenseitiger Anschluss	Schlauchpaketausführung	Bestellnummer
ABITIG® 12-1	4 m	ED/DD	ZA - WTW-5	Standard	7S6SK043520498A12
	8 m	ED/DD	ZA - WTW-5	Standard	7S6SK083520498A12
	4 m	ED/DD	ZA - WTW-5	High Flex Leder	7S6SH043520498A12
	8 m	ED/DD	ZA - WTW-5	High Flex Leder	7S6SH083520498A12
ABITIG® 18SC	4 m	ED/DD	ZA - WTW-5	Standard	7S7SK043520498A12
	8 m	ED/DD	ZA - WTW-5	Standard	7S7SK083520498A12
	4 m	ED/DD	ZA - WTW-5	High Flex Leder	7S7SH043520498A12
	8 m	ED/DD	ZA - WTW-5	High Flex Leder	7S7SH083520498A12
ABITIG® 24W	4 m	ED/DD	ZA - WTW-5	Standard	7S9SK043520498A12
	8 m	ED/DD	ZA - WTW-5	Standard	7S9SK083520498A12
	4 m	ED/DD	ZA - WTW-5	High Flex Leder	7S9SH043520498A12
	8 m	ED/DD	ZA - WTW-5	High Flex Leder	7S9SH083520498A12
ABITIG® 24W Little	4 m	ED/DD	ZA - WTW-5	High Flex Leder	7L9SH043520498A12
	8 m	ED/DD	ZA - WTW-5	High Flex Leder	7L9SH083520498A12
ABITIG® 450W	4 m	ED/DD	ZA - WTW-5	Standard	7T5SK043520498A12
	8 m	ED/DD	ZA - WTW-5	Standard	7T5SK083520498A12
	4 m	ED/DD	ZA - WTW-5	High Flex Leder	7T5SH043520498A12
	8 m	ED/DD	ZA - WTW-5	High Flex Leder	7T5SH083520498A12
ABITIG® 260W	4 m	ED/DD	ZA - WTW-5	Standard	7T7SK043520498A12
	8 m	ED/DD	ZA - WTW-5	Standard	7T7SK083520498A12
	4 m	ED/DD	ZA - WTW-5	High Flex Leder	7T7SH043520498A12
	8 m	ED/DD	ZA - WTW-5	High Flex Leder	7T7SH083520498A12
ABITIG® 260W Little	4 m	ED/DD	ZA - WTW-5	High Flex Leder	7L7SH043520498A12
	8 m	ED/DD	ZA - WTW-5	High Flex Leder	7L7SH083520498A12
ABITIG® 450W SC	4 m	ED/DD	ZA - WTW-5	Standard	
	8 m	ED/DD	ZA - WTW-5	Standard	
	4 m	ED/DD	ZA - WTW-5	High Flex Leder	7T8SH043520498A12
	8 m	ED/DD	ZA - WTW-5	High Flex Leder	7T8SH083520498A12

ABITIG® GRIP / ABITIG® GRIP Little-Brennerpreisliste

passend für WIG-Stromquellen des Fabrikates „oerlikon“



Brennertyp	Länge	Schalterfunktion	maschinenseitiger Anschluss	Schlauchpaketausführung	Bestellnummer
ABITIG® 9	4 m	DD	oerlikon - ZA Tuchel 5-pol.	Standard	7S1SK043521822A00
	8 m	DD	oerlikon - ZA Tuchel 5-pol.	Standard	7S1SK083521822A00
	4 m	DD	oerlikon - ZA Tuchel 5-pol.	High Flex Leder	7S1SH043521822A00
	8 m	DD	oerlikon - ZA Tuchel 5-pol.	High Flex Leder	7S1SH083521822A00
ABITIG® 9 Little	4 m	DD	oerlikon - ZA Tuchel 5-pol.	High Flex Leder	7L1SH043521822A00
	8 m	DD	oerlikon - ZA Tuchel 5-pol.	High Flex Leder	7L1SH083521822A00
ABITIG® 9F	4 m	DD	oerlikon - ZA Tuchel 5-pol.	Standard	7S1FK043521822A00
	8 m	DD	oerlikon - ZA Tuchel 5-pol.	Standard	7S1FK083521822A00
	4 m	DD	oerlikon - ZA Tuchel 5-pol.	High Flex Leder	7S1FH043521822A00
	8 m	DD	oerlikon - ZA Tuchel 5-pol.	High Flex Leder	7S1FH083521822A00
ABITIG® 9F Little	4 m	DD	oerlikon - ZA Tuchel 5-pol.	High Flex Leder	7L1FH043521822A00
	8 m	DD	oerlikon - ZA Tuchel 5-pol.	High Flex Leder	7L1FH083521822A00
ABITIG® 17	4 m	DD	oerlikon - ZA Tuchel 5-pol.	Standard	7S2SK043521822A00
	8 m	DD	oerlikon - ZA Tuchel 5-pol.	Standard	7S2SK083521822A00
	4 m	DD	oerlikon - ZA Tuchel 5-pol.	High Flex Leder	7S2SH043521822A00
	8 m	DD	oerlikon - ZA Tuchel 5-pol.	High Flex Leder	7S2SH083521822A00
ABITIG® 17 Little	4 m	DD	oerlikon - ZA Tuchel 5-pol.	High Flex Leder	7L2SH043521822A00
	8 m	DD	oerlikon - ZA Tuchel 5-pol.	High Flex Leder	7L2SH083521822A00
ABITIG® 17F	4 m	DD	oerlikon - ZA Tuchel 5-pol.	Standard	7S2FK043521822A00
	8 m	DD	oerlikon - ZA Tuchel 5-pol.	Standard	7S2FK083521822A00
	4 m	DD	oerlikon - ZA Tuchel 5-pol.	High Flex Leder	7S2FH043521822A00
	8 m	DD	oerlikon - ZA Tuchel 5-pol.	High Flex Leder	7S2FH083521822A00
ABITIG® 17F Little	4 m	DD	oerlikon - ZA Tuchel 5-pol.	High Flex Leder	7L2FH043521822A00
	8 m	DD	oerlikon - ZA Tuchel 5-pol.	High Flex Leder	7L2FH083521822A00

Technische Änderungen vorbehalten • Verkaufspreise = unverbindliche Preisempfehlung - Angebot freibleibend • © Copyright

ABITIG® GRIP / ABITIG® GRIP Little-Brennerpreisliste

passend für WIG-Stromquellen des Fabrikates „oerlikon“

Brennertyp	Länge	Schalterfunktion	maschinenseitiger Anschluss	Schlauchpaketausführung	Bestellnummer
ABITIG® 26	4 m	DD	oerlikon - ZA Tuchel 5-pol.	Standard	7S3SK043521822A00
	8 m	DD	oerlikon - ZA Tuchel 5-pol.	Standard	7S3SK083521822A00
	4 m	DD	oerlikon - ZA Tuchel 5-pol.	High Flex Leder	7S3SH043521822A00
	8 m	DD	oerlikon - ZA Tuchel 5-pol.	High Flex Leder	7S3SH083521822A00
ABITIG® 26F	4 m	DD	oerlikon - ZA Tuchel 5-pol.	Standard	7S3FK043521822A00
	8 m	DD	oerlikon - ZA Tuchel 5-pol.	Standard	7S3FK083521822A00
	4 m	DD	oerlikon - ZA Tuchel 5-pol.	High Flex Leder	7S3FH043521822A00
	8 m	DD	oerlikon - ZA Tuchel 5-pol.	High Flex Leder	7S3FH083521822A00
ABITIG® 24G	4 m	DD	oerlikon - ZA Tuchel 5-pol.	Standard	7S8SK043521822A00
	8 m	DD	oerlikon - ZA Tuchel 5-pol.	Standard	7S8SK083521822A00
	4 m	DD	oerlikon - ZA Tuchel 5-pol.	High Flex Leder	7S8SH043521822A00
	8 m	DD	oerlikon - ZA Tuchel 5-pol.	High Flex Leder	7S8SH083521822A00
ABITIG® 24G Little	4 m	DD	oerlikon - ZA Tuchel 5-pol.	High Flex Leder	7L8SH043521822A00
	8 m	DD	oerlikon - ZA Tuchel 5-pol.	High Flex Leder	7L8SH083521822A00
ABITIG® 200	4 m	DD	oerlikon - ZA Tuchel 5-pol.	Standard	7T4SK043521822A00
	8 m	DD	oerlikon - ZA Tuchel 5-pol.	Standard	7T4SK083521822A00
	4 m	DD	oerlikon - ZA Tuchel 5-pol.	High Flex Leder	7T4SH043521822A00
	8 m	DD	oerlikon - ZA Tuchel 5-pol.	High Flex Leder	7T4SH083521822A00
ABITIG® 200F	4 m	DD	oerlikon - ZA Tuchel 5-pol.	Standard	7T4FK043521822A00
	8 m	DD	oerlikon - ZA Tuchel 5-pol.	Standard	7T4FK083521822A00
	4 m	DD	oerlikon - ZA Tuchel 5-pol.	High Flex Leder	7T4FH043521822A00
	8 m	DD	oerlikon - ZA Tuchel 5-pol.	High Flex Leder	7T4FH083521822A00
ABITIG® 150	4 m	DD	oerlikon - ZA Tuchel 5-pol.	Standard	7T6SK043521822A00
	8 m	DD	oerlikon - ZA Tuchel 5-pol.	Standard	7T6SK083521822A00
	4 m	DD	oerlikon - ZA Tuchel 5-pol.	High Flex Leder	7T6SH043521822A00
	8 m	DD	oerlikon - ZA Tuchel 5-pol.	High Flex Leder	7T6SH083521822A00
ABITIG® 150 Little	4 m	DD	oerlikon - ZA Tuchel 5-pol.	High Flex Leder	7L6SH043521822A00
	8 m	DD	oerlikon - ZA Tuchel 5-pol.	High Flex Leder	7L6SH083521822A00
ABITIG® 150F	4 m	DD	oerlikon - ZA Tuchel 5-pol.	Standard	7T6FK043521822A00
	8 m	DD	oerlikon - ZA Tuchel 5-pol.	Standard	7T6FK083521822A00
	4 m	DD	oerlikon - ZA Tuchel 5-pol.	High Flex Leder	7T6FH043521822A00
	8 m	DD	oerlikon - ZA Tuchel 5-pol.	High Flex Leder	7T6FH083521822A00
ABITIG® 150F Little	4 m	DD	oerlikon - ZA Tuchel 5-pol.	High Flex Leder	7L6FH043521822A00
	8 m	DD	oerlikon - ZA Tuchel 5-pol.	High Flex Leder	7L6FH083521822A00

ABITIG® GRIP / ABITIG® GRIP Little-Brennerpreisliste

passend für WIG-Stromquellen des Fabrikates „oerlikon“ Prestotig



Brennertyp	Länge	Schalterfunktion	maschinenseitiger Anschluss	Schlauchpaketausführung	Bestellnummer
ABITIG® 9	4 m	DD	oerlikon - BSB / CG Tuchel 5-pol.	Standard	7S1SK043522522A00
	8 m	DD	oerlikon - BSB / CG Tuchel 5-pol.	Standard	7S1SK083522522A00
	4 m	DD	oerlikon - BSB / CG Tuchel 5-pol.	High Flex Leder	7S1SH043522522A00
	8 m	DD	oerlikon - BSB / CG Tuchel 5-pol.	High Flex Leder	7S1SH083522522A00
ABITIG® 9 Little	4 m	DD	oerlikon - BSB / CG Tuchel 5-pol.	High Flex Leder	7L1SH043522522A00
	8 m	DD	oerlikon - BSB / CG Tuchel 5-pol.	High Flex Leder	7L1SH083522522A00
ABITIG® 9F	4 m	DD	oerlikon - BSB / CG Tuchel 5-pol.	Standard	7S1FK043522522A00
	8 m	DD	oerlikon - BSB / CG Tuchel 5-pol.	Standard	7S1FK083522522A00
	4 m	DD	oerlikon - BSB / CG Tuchel 5-pol.	High Flex Leder	7S1FH043522522A00
	8 m	DD	oerlikon - BSB / CG Tuchel 5-pol.	High Flex Leder	7S1FH083522522A00
ABITIG® 9F Little	4 m	DD	oerlikon - BSB / CG Tuchel 5-pol.	High Flex Leder	7L1FH043522522A00
	8 m	DD	oerlikon - BSB / CG Tuchel 5-pol.	High Flex Leder	7L1FH083522522A00
ABITIG® 17	4 m	DD	oerlikon - BSB / CG Tuchel 5-pol.	Standard	7S2SK043522522A00
	8 m	DD	oerlikon - BSB / CG Tuchel 5-pol.	Standard	7S2SK083522522A00
	4 m	DD	oerlikon - BSB / CG Tuchel 5-pol.	High Flex Leder	7S2SH043522522A00
	8 m	DD	oerlikon - BSB / CG Tuchel 5-pol.	High Flex Leder	7S2SH083522522A00
ABITIG® 17 Little	4 m	DD	oerlikon - BSB / CG Tuchel 5-pol.	High Flex Leder	7L2SH043522522A00
	8 m	DD	oerlikon - BSB / CG Tuchel 5-pol.	High Flex Leder	7L2SH083522522A00
ABITIG® 17F	4 m	DD	oerlikon - BSB / CG Tuchel 5-pol.	Standard	7S2FK043522522A00
	8 m	DD	oerlikon - BSB / CG Tuchel 5-pol.	Standard	7S2FK083522522A00
	4 m	DD	oerlikon - BSB / CG Tuchel 5-pol.	High Flex Leder	7S2FH043522522A00
	8 m	DD	oerlikon - BSB / CG Tuchel 5-pol.	High Flex Leder	7S2FH083522522A00
ABITIG® 17F Little	4 m	DD	oerlikon - BSB / CG Tuchel 5-pol.	High Flex Leder	7L2FH043522522A00
	8 m	DD	oerlikon - BSB / CG Tuchel 5-pol.	High Flex Leder	7L2FH083522522A00

Technische Änderungen vorbehalten • Verkaufspreise = unverbindliche Preisempfehlung - Angebot freibleibend • © Copyright

ABITIG® GRIP / ABITIG® GRIP Little-Brennerpreisliste

passend für WIG-Stromquellen des Fabrikates „oerlikon“ Prestotig

Brennertyp	Länge	Schalterfunktion	maschinenseitiger Anschluss	Schlauchpaketausführung	Bestellnummer
ABITIG® 26	4 m	DD	oerlikon - BSB / CG Tuchel 5-pol.	Standard	7S3SK043522522A00
	8 m	DD	oerlikon - BSB / CG Tuchel 5-pol.	Standard	7S3SK083522522A00
	4 m	DD	oerlikon - BSB / CG Tuchel 5-pol.	High Flex Leder	7S3SH043522522A00
	8 m	DD	oerlikon - BSB / CG Tuchel 5-pol.	High Flex Leder	7S3SH083522522A00
ABITIG® 26F	4 m	DD	oerlikon - BSB / CG Tuchel 5-pol.	Standard	7S3FK043522522A00
	8 m	DD	oerlikon - BSB / CG Tuchel 5-pol.	Standard	7S3FK083522522A00
	4 m	DD	oerlikon - BSB / CG Tuchel 5-pol.	High Flex Leder	7S3FH043522522A00
	8 m	DD	oerlikon - BSB / CG Tuchel 5-pol.	High Flex Leder	7S3FH083522522A00
ABITIG® 24G	4 m	DD	oerlikon - BSB / CG Tuchel 5-pol.	Standard	7S8SK043522522A00
	8 m	DD	oerlikon - BSB / CG Tuchel 5-pol.	Standard	7S8SK083522522A00
	4 m	DD	oerlikon - BSB / CG Tuchel 5-pol.	High Flex Leder	7S8SH043522522A00
	8 m	DD	oerlikon - BSB / CG Tuchel 5-pol.	High Flex Leder	7S8SH083522522A00
ABITIG® 24G Little	4 m	DD	oerlikon - BSB / CG Tuchel 5-pol.	High Flex Leder	7L8SH043522522A00
	8 m	DD	oerlikon - BSB / CG Tuchel 5-pol.	High Flex Leder	7L8SH083522522A00
ABITIG® 200	4 m	DD	oerlikon - BSB / CG Tuchel 5-pol.	Standard	7T4SK043522522A00
	8 m	DD	oerlikon - BSB / CG Tuchel 5-pol.	Standard	7T4SK083522522A00
	4 m	DD	oerlikon - BSB / CG Tuchel 5-pol.	High Flex Leder	7T4SH043522522A00
	8 m	DD	oerlikon - BSB / CG Tuchel 5-pol.	High Flex Leder	7T4SH083522522A00
ABITIG® 200F	4 m	DD	oerlikon - BSB / CG Tuchel 5-pol.	Standard	7T4FK043522522A00
	8 m	DD	oerlikon - BSB / CG Tuchel 5-pol.	Standard	7T4FK083522522A00
	4 m	DD	oerlikon - BSB / CG Tuchel 5-pol.	High Flex Leder	7T4FH043522522A00
	8 m	DD	oerlikon - BSB / CG Tuchel 5-pol.	High Flex Leder	7T4FH083522522A00
ABITIG® 150	4 m	DD	oerlikon - BSB / CG Tuchel 5-pol.	Standard	7T6SK043522522A00
	8 m	DD	oerlikon - BSB / CG Tuchel 5-pol.	Standard	7T6SK083522522A00
	4 m	DD	oerlikon - BSB / CG Tuchel 5-pol.	High Flex Leder	7T6SH043522522A00
	8 m	DD	oerlikon - BSB / CG Tuchel 5-pol.	High Flex Leder	7T6SH083522522A00
ABITIG® 150 Little	4 m	DD	oerlikon - BSB / CG Tuchel 5-pol.	High Flex Leder	7L6SH043522522A00
	8 m	DD	oerlikon - BSB / CG Tuchel 5-pol.	High Flex Leder	7L6SH083522522A00
ABITIG® 150F	4 m	DD	oerlikon - BSB / CG Tuchel 5-pol.	Standard	7T6FK043522522A00
	8 m	DD	oerlikon - BSB / CG Tuchel 5-pol.	Standard	7T6FK083522522A00
	4 m	DD	oerlikon - BSB / CG Tuchel 5-pol.	High Flex Leder	7T6FH043522522A00
	8 m	DD	oerlikon - BSB / CG Tuchel 5-pol.	High Flex Leder	7T6FH083522522A00
ABITIG® 150F Little	4 m	DD	oerlikon - BSB / CG Tuchel 5-pol.	High Flex Leder	7L6FH043522522A00
	8 m	DD	oerlikon - BSB / CG Tuchel 5-pol.	High Flex Leder	7L6FH083522522A00

ABITIG® GRIP / ABITIG® GRIP Little-Brennerpreisliste

passend für WIG-Stromquellen des Fabrikates „oerlikon“ ZA flüssiggekühlt

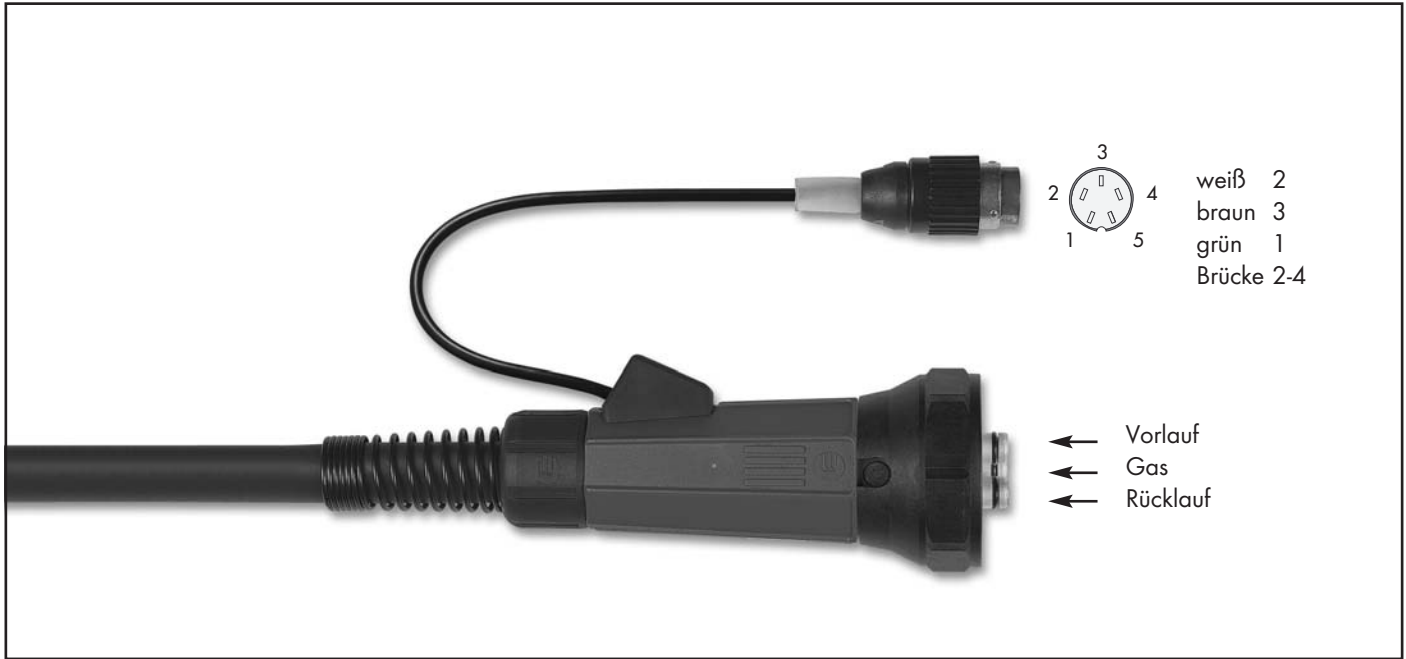

Brennertyp	Länge	Schalterfunktion	maschinenseitiger Anschluss	Schlauchpaketausführung	Bestellnummer
ABITIG® 18	4 m	DD	oerlikon - ZA Tuchel 5-pol.	Standard	7S4SK043521904A00
	8 m	DD	oerlikon - ZA Tuchel 5-pol.	Standard	7S4SK083521904A00
	4 m	DD	oerlikon - ZA Tuchel 5-pol.	High Flex Leder	7S4SH043521904A00
	8 m	DD	oerlikon - ZA Tuchel 5-pol.	High Flex Leder	7S4SH083521904A00
ABITIG® 18F	4 m	DD	oerlikon - ZA Tuchel 5-pol.	Standard	7S4FK043521904A00
	8 m	DD	oerlikon - ZA Tuchel 5-pol.	Standard	7S4FK083521904A00
	4 m	DD	oerlikon - ZA Tuchel 5-pol.	High Flex Leder	7S4FH043521904A00
	8 m	DD	oerlikon - ZA Tuchel 5-pol.	High Flex Leder	7S4FH083521904A00
ABITIG® 20	4 m	DD	oerlikon - ZA Tuchel 5-pol.	Standard	7S5SK043521904A00
	8 m	DD	oerlikon - ZA Tuchel 5-pol.	Standard	7S5SK083521904A00
	4 m	DD	oerlikon - ZA Tuchel 5-pol.	High Flex Leder	7S5SH043521904A00
	8 m	DD	oerlikon - ZA Tuchel 5-pol.	High Flex Leder	7S5SH083521904A00
ABITIG® 20 Little	4 m	DD	oerlikon - ZA Tuchel 5-pol.	High Flex Leder	7L5SH043521904A00
	8 m	DD	oerlikon - ZA Tuchel 5-pol.	High Flex Leder	7L5SH083521904A00
ABITIG® 20F	4 m	DD	oerlikon - ZA Tuchel 5-pol.	Standard	7S5FK043521904A00
	8 m	DD	oerlikon - ZA Tuchel 5-pol.	Standard	7S5FK083521904A00
	4 m	DD	oerlikon - ZA Tuchel 5-pol.	High Flex Leder	7S5FH043521904A00
	8 m	DD	oerlikon - ZA Tuchel 5-pol.	High Flex Leder	7S5FH083521904A00
ABITIG® 20F Little	4 m	DD	oerlikon - ZA Tuchel 5-pol.	High Flex Leder	7L5FH043521904A00
	8 m	DD	oerlikon - ZA Tuchel 5-pol.	High Flex Leder	7L5FH083521904A00

Technische Änderungen vorbehalten • Verkaufspreise = unverbindliche Preisempfehlung - Angebot freibleibend • © Copyright

ABITIG® GRIP / ABITIG® GRIP Little-Brennerpreisliste

passend für WIG-Stromquellen des Fabrikates „oerlikon“ ZA flüssiggekühlt

Brennertyp	Länge	Schalterfunktion	maschinenseitiger Anschluss	Schlauchpaketausführung	Bestellnummer
ABITIG® 12-1	4 m	DD	oerlikon - ZA Tuchel 5-pol.	Standard	7S6SK043521904A00
	8 m	DD	oerlikon - ZA Tuchel 5-pol.	Standard	7S6SK083521904A00
	4 m	DD	oerlikon - ZA Tuchel 5-pol.	High Flex Leder	7S6SH043521904A00
	8 m	DD	oerlikon - ZA Tuchel 5-pol.	High Flex Leder	7S6SH083521904A00
ABITIG® 18SC	4 m	DD	oerlikon - ZA Tuchel 5-pol.	Standard	7S7SK043521904A00
	8 m	DD	oerlikon - ZA Tuchel 5-pol.	Standard	7S7SK083521904A00
	4 m	DD	oerlikon - ZA Tuchel 5-pol.	High Flex Leder	7S7SH043521904A00
	8 m	DD	oerlikon - ZA Tuchel 5-pol.	High Flex Leder	7S7SH083521904A00
ABITIG® 24W	4 m	DD	oerlikon - ZA Tuchel 5-pol.	Standard	7S9SK043521904A00
	8 m	DD	oerlikon - ZA Tuchel 5-pol.	Standard	7S9SK083521904A00
	4 m	DD	oerlikon - ZA Tuchel 5-pol.	High Flex Leder	7S9SH043521904A00
	8 m	DD	oerlikon - ZA Tuchel 5-pol.	High Flex Leder	7L9SH083521904A00
ABITIG® 24W Little	4 m	DD	oerlikon - ZA Tuchel 5-pol.	High Flex Leder	7L9SH043521904A00
	8 m	DD	oerlikon - ZA Tuchel 5-pol.	High Flex Leder	7S9SH083521904A00
ABITIG® 450W	4 m	DD	oerlikon - ZA Tuchel 5-pol.	Standard	7T5SK043521904A00
	8 m	DD	oerlikon - ZA Tuchel 5-pol.	Standard	7T5SK083521904A00
	4 m	DD	oerlikon - ZA Tuchel 5-pol.	High Flex Leder	7T5SH043521904A00
	8 m	DD	oerlikon - ZA Tuchel 5-pol.	High Flex Leder	7T5SH083521904A00
ABITIG® 260W	4 m	DD	oerlikon - ZA Tuchel 5-pol.	Standard	7T7SK043521904A00
	8 m	DD	oerlikon - ZA Tuchel 5-pol.	Standard	7T7SK083521904A00
	4 m	DD	oerlikon - ZA Tuchel 5-pol.	High Flex Leder	7T7SH043521904A00
	8 m	DD	oerlikon - ZA Tuchel 5-pol.	High Flex Leder	7T7SH083521904A00
ABITIG® 260W Little	4 m	DD	oerlikon - ZA Tuchel 5-pol.	High Flex Leder	7L7SH043521904A00
	8 m	DD	oerlikon - ZA Tuchel 5-pol.	High Flex Leder	7L7SH083521904A00
ABITIG® 450W SC	4 m	DD	oerlikon - ZA Tuchel 5-pol.	Standard	
	8 m	DD	oerlikon - ZA Tuchel 5-pol.	Standard	
	4 m	DD	oerlikon - ZA Tuchel 5-pol.	High Flex Leder	7T8SH043521904A00
	8 m	DD	oerlikon - ZA Tuchel 5-pol.	High Flex Leder	7T8SH083521904A00

ABITIG® GRIP / ABITIG® GRIP Little-Brennerpreisliste

passend für WIG-Stromquellen des Fabrikates „oerlikon“ Prestotig



Brennertyp	Länge	Schalterfunktion	maschinenseitiger Anschluss	Schlauchpaketausführung	Bestellnummer
ABITIG® 18	4 m	DD	oerlikon - BSB / CG Tuchel 5-pol.	Standard	7S4SK043522504A12
	8 m	DD	oerlikon - BSB / CG Tuchel 5-pol.	Standard	7S4SK083522504A12
	4 m	DD	oerlikon - BSB / CG Tuchel 5-pol.	High Flex Leder	7S4SH043522504A12
	8 m	DD	oerlikon - BSB / CG Tuchel 5-pol.	High Flex Leder	7S4SH083522504A12
ABITIG® 18F	4 m	DD	oerlikon - BSB / CG Tuchel 5-pol.	Standard	7S4FK043522504A12
	8 m	DD	oerlikon - BSB / CG Tuchel 5-pol.	Standard	7S4FK083522504A12
	4 m	DD	oerlikon - BSB / CG Tuchel 5-pol.	High Flex Leder	7S4FH043522504A12
	8 m	DD	oerlikon - BSB / CG Tuchel 5-pol.	High Flex Leder	7S4FH083522504A12
ABITIG® 20	4 m	DD	oerlikon - BSB / CG Tuchel 5-pol.	Standard	7S5SK043522504A12
	8 m	DD	oerlikon - BSB / CG Tuchel 5-pol.	Standard	7S5SK083522504A12
	4 m	DD	oerlikon - BSB / CG Tuchel 5-pol.	High Flex Leder	7S5SH043522504A12
	8 m	DD	oerlikon - BSB / CG Tuchel 5-pol.	High Flex Leder	7S5SH083522504A12
ABITIG® 20 Little	4 m	DD	oerlikon - BSB / CG Tuchel 5-pol.	High Flex Leder	7L5SH043522504A12
	8 m	DD	oerlikon - BSB / CG Tuchel 5-pol.	High Flex Leder	7L5SH083522504A12
ABITIG® 20F	4 m	DD	oerlikon - BSB / CG Tuchel 5-pol.	Standard	7S5FK043522504A12
	8 m	DD	oerlikon - BSB / CG Tuchel 5-pol.	Standard	7S5FK083522504A12
	4 m	DD	oerlikon - BSB / CG Tuchel 5-pol.	High Flex Leder	7S5FH043522504A12
	8 m	DD	oerlikon - BSB / CG Tuchel 5-pol.	High Flex Leder	7S5FH083522504A12
ABITIG® 20F Little	4 m	DD	oerlikon - BSB / CG Tuchel 5-pol.	High Flex Leder	7L5FH043522504A12
	8 m	DD	oerlikon - BSB / CG Tuchel 5-pol.	High Flex Leder	7L5FH083522504A12

Technische Änderungen vorbehalten • Verkaufspreise = unverbindliche Preisempfehlung - Angebot freibleibend • © Copyright

ABITIG® GRIP / ABITIG® GRIP Little-Brennerpreisliste

passend für WIG-Stromquellen des Fabrikates „oerlikon“ Prestotig

Brennertyp	Länge	Schalterfunktion	maschinenseitiger Anschluss	Schlauchpaketausführung	Bestellnummer
ABITIG® 12-1	4 m	DD	oerlikon - BSB / CG Tuchel 5-pol.	Standard	7S6SK043522504A12
	8 m	DD	oerlikon - BSB / CG Tuchel 5-pol.	Standard	7S6SK083522504A12
	4 m	DD	oerlikon - BSB / CG Tuchel 5-pol.	High Flex Leder	7S6SH043522504A12
	8 m	DD	oerlikon - BSB / CG Tuchel 5-pol.	High Flex Leder	7S6SH083522504A12
ABITIG® 18SC	4 m	DD	oerlikon - BSB / CG Tuchel 5-pol.	Standard	7S7SK043522504A12
	8 m	DD	oerlikon - BSB / CG Tuchel 5-pol.	Standard	7S7SK083522504A12
	4 m	DD	oerlikon - BSB / CG Tuchel 5-pol.	High Flex Leder	7S7SH043522504A12
	8 m	DD	oerlikon - BSB / CG Tuchel 5-pol.	High Flex Leder	7S7SH083522504A12
ABITIG® 24W	4 m	DD	oerlikon - BSB / CG Tuchel 5-pol.	Standard	7S9SK043522504A12
	8 m	DD	oerlikon - BSB / CG Tuchel 5-pol.	Standard	7S9SK083522504A12
	4 m	DD	oerlikon - BSB / CG Tuchel 5-pol.	High Flex Leder	7S9SH043522504A12
	8 m	DD	oerlikon - BSB / CG Tuchel 5-pol.	High Flex Leder	7S9SH083522504A12
ABITIG® 24W Little	4 m	DD	oerlikon - BSB / CG Tuchel 5-pol.	High Flex Leder	7L9SH043522504A12
	8 m	DD	oerlikon - BSB / CG Tuchel 5-pol.	High Flex Leder	7L9SH083522504A12
ABITIG® 450W	4 m	DD	oerlikon - BSB / CG Tuchel 5-pol.	Standard	7T5SK043522504A12
	8 m	DD	oerlikon - BSB / CG Tuchel 5-pol.	Standard	7T5SK083522504A12
	4 m	DD	oerlikon - BSB / CG Tuchel 5-pol.	High Flex Leder	7T5SH043522504A12
	8 m	DD	oerlikon - BSB / CG Tuchel 5-pol.	High Flex Leder	7T5SH083522504A12
ABITIG® 260W	4 m	DD	oerlikon - BSB / CG Tuchel 5-pol.	Standard	7T7SK043522504A12
	8 m	DD	oerlikon - BSB / CG Tuchel 5-pol.	Standard	7T7SK083522504A12
	4 m	DD	oerlikon - BSB / CG Tuchel 5-pol.	High Flex Leder	7T7SH043522504A12
	8 m	DD	oerlikon - BSB / CG Tuchel 5-pol.	High Flex Leder	7T7SH083522504A12
ABITIG® 260W Little	4 m	DD	oerlikon - BSB / CG Tuchel 5-pol.	High Flex Leder	7L7SH043522504A12
	8 m	DD	oerlikon - BSB / CG Tuchel 5-pol.	High Flex Leder	7L7SH083522504A12
ABITIG® 450W SC	4 m	DD	oerlikon - BSB / CG Tuchel 5-pol.	Standard	
	8 m	DD	oerlikon - BSB / CG Tuchel 5-pol.	Standard	
	4 m	DD	oerlikon - BSB / CG Tuchel 5-pol.	High Flex Leder	7T8SH043522504A12
	8 m	DD	oerlikon - BSB / CG Tuchel 5-pol.	High Flex Leder	7T8SH083522504A12

ABITIG® GRIP / ABITIG® GRIP Little-Brennerpreisliste

passend für WIG-Stromquellen des Fabrikates „pego“

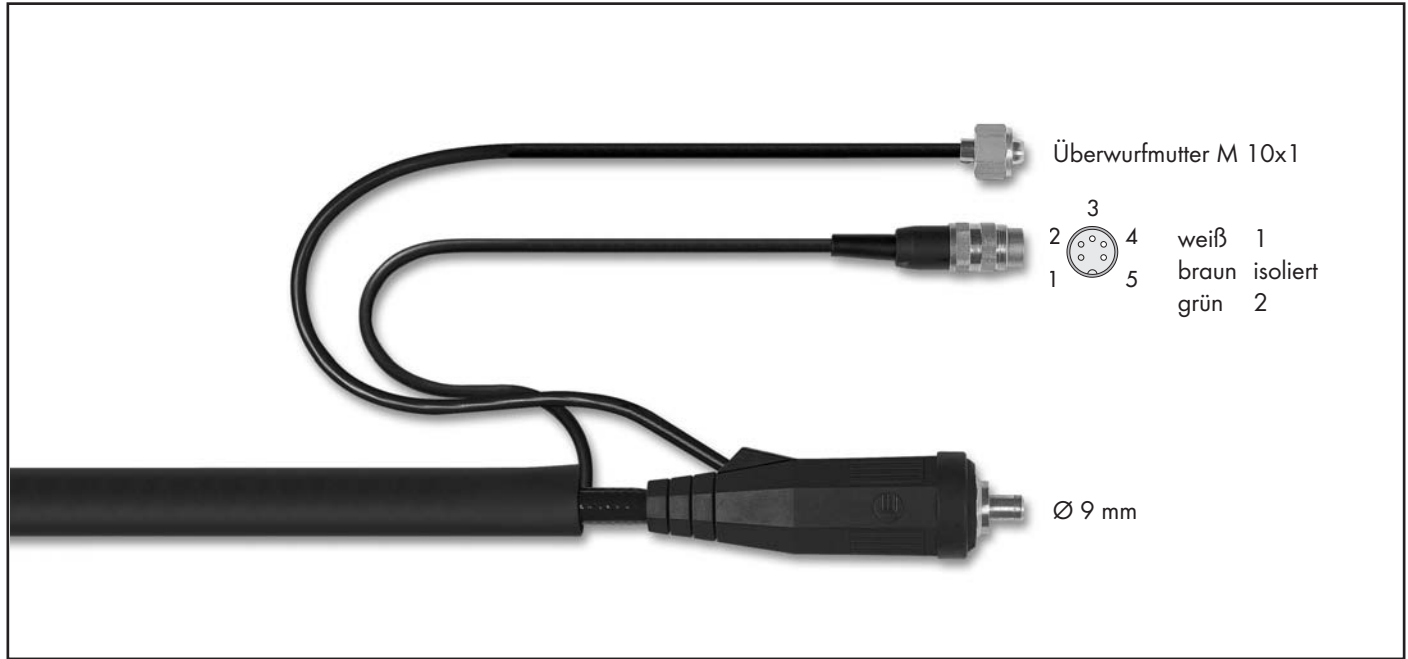

Brennertyp	Länge	Schalterfunktion	maschinenseitiger Anschluss	Schlauchpaketausführung	Bestellnummer
ABITIG® 9	4 m	ED	BSB 10-25 Rundsteckverb. 5-pol.	Standard	7S1SK043512235A54
	8 m	ED	BSB 10-25 Rundsteckverb. 5-pol.	Standard	7S1SK083512235A54
	4 m	ED	BSB 10-25 Rundsteckverb. 5-pol.	High Flex Leder	7S1SH043512235A54
	8 m	ED	BSB 10-25 Rundsteckverb. 5-pol.	High Flex Leder	7S1SH083512235A54
ABITIG® 9 Little	4 m	ED	BSB 10-25 Rundsteckverb. 5-pol.	High Flex Leder	7L1SH043512235A54
	8 m	ED	BSB 10-25 Rundsteckverb. 5-pol.	High Flex Leder	7L1SH083512235A54
ABITIG® 9F	4 m	ED	BSB 10-25 Rundsteckverb. 5-pol.	Standard	7S1FK043512235A54
	8 m	ED	BSB 10-25 Rundsteckverb. 5-pol.	Standard	7S1FK083512235A54
	4 m	ED	BSB 10-25 Rundsteckverb. 5-pol.	High Flex Leder	7S1FH043512235A54
	8 m	ED	BSB 10-25 Rundsteckverb. 5-pol.	High Flex Leder	7S1FH083512235A54
ABITIG® 9F Little	4 m	ED	BSB 10-25 Rundsteckverb. 5-pol.	High Flex Leder	7L1FH043512235A54
	8 m	ED	BSB 10-25 Rundsteckverb. 5-pol.	High Flex Leder	7L1FH083512235A54
ABITIG® 17	4 m	ED	BSB 10-25 Rundsteckverb. 5-pol.	Standard	7S2SK043512235A54
	8 m	ED	BSB 10-25 Rundsteckverb. 5-pol.	Standard	7S2SK083512235A54
	4 m	ED	BSB 10-25 Rundsteckverb. 5-pol.	High Flex Leder	7S2SH043512235A54
	8 m	ED	BSB 10-25 Rundsteckverb. 5-pol.	High Flex Leder	7S2SH083512235A54
ABITIG® 17 Little	4 m	ED	BSB 10-25 Rundsteckverb. 5-pol.	High Flex Leder	7L2SH043512235A54
	8 m	ED	BSB 10-25 Rundsteckverb. 5-pol.	High Flex Leder	7L2SH083512235A54
ABITIG® 17F	4 m	ED	BSB 10-25 Rundsteckverb. 5-pol.	Standard	7S2FK043512235A54
	8 m	ED	BSB 10-25 Rundsteckverb. 5-pol.	Standard	7S2FK083512235A54
	4 m	ED	BSB 10-25 Rundsteckverb. 5-pol.	High Flex Leder	7S2FH043512235A54
	8 m	ED	BSB 10-25 Rundsteckverb. 5-pol.	High Flex Leder	7S2FH083512235A54
ABITIG® 17F Little	4 m	ED	BSB 10-25 Rundsteckverb. 5-pol.	High Flex Leder	7L2FH043512235A54
	8 m	ED	BSB 10-25 Rundsteckverb. 5-pol.	High Flex Leder	7L2FH083512235A54

Technische Änderungen vorbehalten • Verkaufspreise = unverbindliche Preisempfehlung - Angebot freibleibend • © Copyright

ABITIG® GRIP / ABITIG® GRIP Little-Brennerpreisliste

passend für WIG-Stromquellen des Fabrikates „pego“

Brennertyp	Länge	Schalterfunktion	maschinenseitiger Anschluss	Schlauchpaketausführung	Bestellnummer
ABITIG® 26	4 m	ED	BSB 10-25 Rundsteckverb. 5-pol.	Standard	7S3SK043512235A54
	8 m	ED	BSB 10-25 Rundsteckverb. 5-pol.	Standard	7S3SK083512235A54
	4 m	ED	BSB 10-25 Rundsteckverb. 5-pol.	High Flex Leder	7S3SH043512235A54
	8 m	ED	BSB 10-25 Rundsteckverb. 5-pol.	High Flex Leder	7S3SH083512235A54
ABITIG® 26F	4 m	ED	BSB 10-25 Rundsteckverb. 5-pol.	Standard	7S3FK043512235A54
	8 m	ED	BSB 10-25 Rundsteckverb. 5-pol.	Standard	7S3FK083512235A54
	4 m	ED	BSB 10-25 Rundsteckverb. 5-pol.	High Flex Leder	7S3FH043512235A54
	8 m	ED	BSB 10-25 Rundsteckverb. 5-pol.	High Flex Leder	7S3FH083512235A54
ABITIG® 24G	4 m	ED	BSB 10-25 Rundsteckverb. 5-pol.	Standard	7S8SK043512235A54
	8 m	ED	BSB 10-25 Rundsteckverb. 5-pol.	Standard	7S8SK083512235A54
	4 m	ED	BSB 10-25 Rundsteckverb. 5-pol.	High Flex Leder	7S8SH043512235A54
	8 m	ED	BSB 10-25 Rundsteckverb. 5-pol.	High Flex Leder	7S8SH083512235A54
ABITIG® 24G Little	4 m	ED	BSB 10-25 Rundsteckverb. 5-pol.	High Flex Leder	7L8SH043512235A54
	8 m	ED	BSB 10-25 Rundsteckverb. 5-pol.	High Flex Leder	7L8SH083512235A54
ABITIG® 200	4 m	ED	BSB 10-25 Rundsteckverb. 5-pol.	Standard	7T4SK043512235A54
	8 m	ED	BSB 10-25 Rundsteckverb. 5-pol.	Standard	7T4SK083512235A54
	4 m	ED	BSB 10-25 Rundsteckverb. 5-pol.	High Flex Leder	7T4SH043512235A54
	8 m	ED	BSB 10-25 Rundsteckverb. 5-pol.	High Flex Leder	7T4SH083512235A54
ABITIG® 200F	4 m	ED	BSB 10-25 Rundsteckverb. 5-pol.	Standard	7T4FK043512235A54
	8 m	ED	BSB 10-25 Rundsteckverb. 5-pol.	Standard	7T4FK083512235A54
	4 m	ED	BSB 10-25 Rundsteckverb. 5-pol.	High Flex Leder	7T4FH043512235A54
	8 m	ED	BSB 10-25 Rundsteckverb. 5-pol.	High Flex Leder	7T4FH083512235A54
ABITIG® 150	4 m	ED	BSB 10-25 Rundsteckverb. 5-pol.	Standard	7T6SK043512235A54
	8 m	ED	BSB 10-25 Rundsteckverb. 5-pol.	Standard	7T6SK083512235A54
	4 m	ED	BSB 10-25 Rundsteckverb. 5-pol.	High Flex Leder	7T6SH043512235A54
	8 m	ED	BSB 10-25 Rundsteckverb. 5-pol.	High Flex Leder	7T6SH083512235A54
ABITIG® 150 Little	4 m	ED	BSB 10-25 Rundsteckverb. 5-pol.	High Flex Leder	7L6SH043512235A54
	8 m	ED	BSB 10-25 Rundsteckverb. 5-pol.	High Flex Leder	7L6SH083512235A54
ABITIG® 150F	4 m	ED	BSB 10-25 Rundsteckverb. 5-pol.	Standard	7T6FK043512235A54
	8 m	ED	BSB 10-25 Rundsteckverb. 5-pol.	Standard	7T6FK083512235A54
	4 m	ED	BSB 10-25 Rundsteckverb. 5-pol.	High Flex Leder	7T6FH043512235A54
	8 m	ED	BSB 10-25 Rundsteckverb. 5-pol.	High Flex Leder	7T6FH083512235A54
ABITIG® 150F Little	4 m	ED	BSB 10-25 Rundsteckverb. 5-pol.	High Flex Leder	7L6FH043512235A54
	8 m	ED	BSB 10-25 Rundsteckverb. 5-pol.	High Flex Leder	7L6FH083512235A54

ABITIG® GRIP / ABITIG® GRIP Little-Brennerpreisliste

passend für WIG-Stromquellen des Fabrikates „pego“

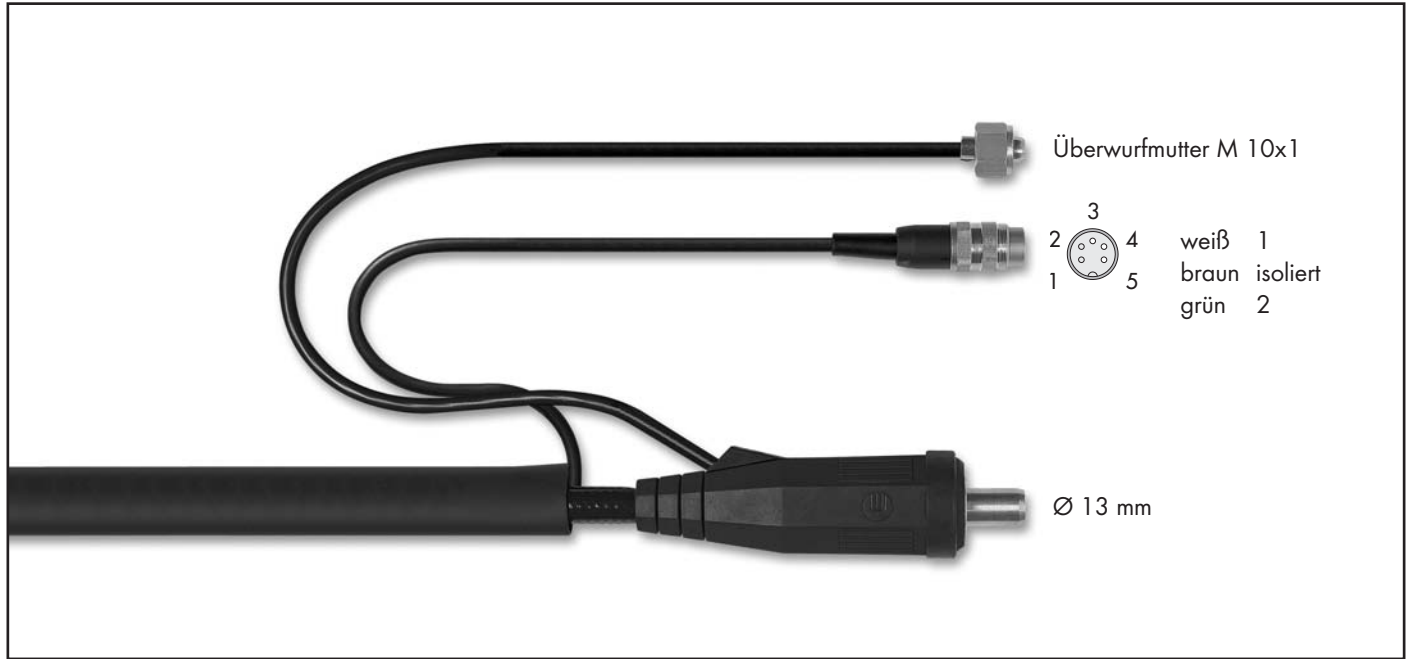

Brennertyp	Länge	Schalterfunktion	maschinenseitiger Anschluss	Schlauchpaketausführung	Bestellnummer
ABITIG® 9	4 m	ED	BSB 35-50 Rundsteckverb. 5-pol.	Standard	7S1SK043510035A54
	8 m	ED	BSB 35-50 Rundsteckverb. 5-pol.	Standard	7S1SK083510035A54
	4 m	ED	BSB 35-50 Rundsteckverb. 5-pol.	High Flex Leder	7S1SH043510035A54
	8 m	ED	BSB 35-50 Rundsteckverb. 5-pol.	High Flex Leder	7S1SH083510035A54
ABITIG® 9 Little	4 m	ED	BSB 35-50 Rundsteckverb. 5-pol.	High Flex Leder	7L1SH043510035A54
	8 m	ED	BSB 35-50 Rundsteckverb. 5-pol.	High Flex Leder	7L1SH083510035A54
ABITIG® 9F	4 m	ED	BSB 35-50 Rundsteckverb. 5-pol.	Standard	7S1FK043510035A54
	8 m	ED	BSB 35-50 Rundsteckverb. 5-pol.	Standard	7S1FK083510035A54
	4 m	ED	BSB 35-50 Rundsteckverb. 5-pol.	High Flex Leder	7S1FH043510035A54
	8 m	ED	BSB 35-50 Rundsteckverb. 5-pol.	High Flex Leder	7S1FH083510035A54
ABITIG® 9F Little	4 m	ED	BSB 35-50 Rundsteckverb. 5-pol.	High Flex Leder	7L1FH043510035A54
	8 m	ED	BSB 35-50 Rundsteckverb. 5-pol.	High Flex Leder	7L1FH083510035A54
ABITIG® 17	4 m	ED	BSB 35-50 Rundsteckverb. 5-pol.	Standard	7S2SK043510035A54
	8 m	ED	BSB 35-50 Rundsteckverb. 5-pol.	Standard	7S2SK083510035A54
	4 m	ED	BSB 35-50 Rundsteckverb. 5-pol.	High Flex Leder	7S2SH043510035A54
	8 m	ED	BSB 35-50 Rundsteckverb. 5-pol.	High Flex Leder	7S2SH083510035A54
ABITIG® 17 Little	4 m	ED	BSB 35-50 Rundsteckverb. 5-pol.	High Flex Leder	7L2SH043510035A54
	8 m	ED	BSB 35-50 Rundsteckverb. 5-pol.	High Flex Leder	7L2SH083510035A54
ABITIG® 17F	4 m	ED	BSB 35-50 Rundsteckverb. 5-pol.	Standard	7S2FK043510035A54
	8 m	ED	BSB 35-50 Rundsteckverb. 5-pol.	Standard	7S2FK083510035A54
	4 m	ED	BSB 35-50 Rundsteckverb. 5-pol.	High Flex Leder	7S2FH043510035A54
	8 m	ED	BSB 35-50 Rundsteckverb. 5-pol.	High Flex Leder	7S2FH083510035A54
ABITIG® 17F Little	4 m	ED	BSB 35-50 Rundsteckverb. 5-pol.	High Flex Leder	7L2FH043510035A54
	8 m	ED	BSB 35-50 Rundsteckverb. 5-pol.	High Flex Leder	7L2FH083510035A54

Technische Änderungen vorbehalten • Verkaufspreise = unverbindliche Preisempfehlung - Angebot freibleibend • © Copyright

ABITIG® GRIP / ABITIG® GRIP Little-Brennerpreisliste

passend für WIG-Stromquellen des Fabrikates „pego“

Brennertyp	Länge	Schalterfunktion	maschinenseitiger Anschluss	Schlauchpaketausführung	Bestellnummer
ABITIG® 26	4 m	ED	BSB 35-50 Rundsteckverb. 5-pol.	Standard	7S3SK043510035A54
	8 m	ED	BSB 35-50 Rundsteckverb. 5-pol.	Standard	7S3SK083510035A54
	4 m	ED	BSB 35-50 Rundsteckverb. 5-pol.	High Flex Leder	7S3SH043510035A54
	8 m	ED	BSB 35-50 Rundsteckverb. 5-pol.	High Flex Leder	7S3SH083510035A54
ABITIG® 26F	4 m	ED	BSB 35-50 Rundsteckverb. 5-pol.	Standard	7S3FK043510035A54
	8 m	ED	BSB 35-50 Rundsteckverb. 5-pol.	Standard	7S3FK083510035A54
	4 m	ED	BSB 35-50 Rundsteckverb. 5-pol.	High Flex Leder	7S3FH043510035A54
	8 m	ED	BSB 35-50 Rundsteckverb. 5-pol.	High Flex Leder	7S3FH083510035A54
ABITIG® 24G	4 m	ED	BSB 35-50 Rundsteckverb. 5-pol.	Standard	7S8SK043510035A54
	8 m	ED	BSB 35-50 Rundsteckverb. 5-pol.	Standard	7S8SK083510035A54
	4 m	ED	BSB 35-50 Rundsteckverb. 5-pol.	High Flex Leder	7S8SH043510035A54
	8 m	ED	BSB 35-50 Rundsteckverb. 5-pol.	High Flex Leder	7S8SH083510035A54
ABITIG® 24G Little	4 m	ED	BSB 35-50 Rundsteckverb. 5-pol.	High Flex Leder	7L8SH043510035A54
	8 m	ED	BSB 35-50 Rundsteckverb. 5-pol.	High Flex Leder	7L8SH083510035A54
ABITIG® 200	4 m	ED	BSB 35-50 Rundsteckverb. 5-pol.	Standard	7T4SK043510035A54
	8 m	ED	BSB 35-50 Rundsteckverb. 5-pol.	Standard	7T4SK083510035A54
	4 m	ED	BSB 35-50 Rundsteckverb. 5-pol.	High Flex Leder	7T4SH043510035A54
	8 m	ED	BSB 35-50 Rundsteckverb. 5-pol.	High Flex Leder	7T4SH083510035A54
ABITIG® 200F	4 m	ED	BSB 35-50 Rundsteckverb. 5-pol.	Standard	7T4FK043510035A54
	8 m	ED	BSB 35-50 Rundsteckverb. 5-pol.	Standard	7T4FK083510035A54
	4 m	ED	BSB 35-50 Rundsteckverb. 5-pol.	High Flex Leder	7T4FH043510035A54
	8 m	ED	BSB 35-50 Rundsteckverb. 5-pol.	High Flex Leder	7T4FH083510035A54
ABITIG® 150	4 m	ED	BSB 35-50 Rundsteckverb. 5-pol.	Standard	7T6SK043510035A54
	8 m	ED	BSB 35-50 Rundsteckverb. 5-pol.	Standard	7T6SK083510035A54
	4 m	ED	BSB 35-50 Rundsteckverb. 5-pol.	High Flex Leder	7T6SH043510035A54
	8 m	ED	BSB 35-50 Rundsteckverb. 5-pol.	High Flex Leder	7T6SH083510035A54
ABITIG® 150 Little	4 m	ED	BSB 35-50 Rundsteckverb. 5-pol.	High Flex Leder	7L6SH043510035A54
	8 m	ED	BSB 35-50 Rundsteckverb. 5-pol.	High Flex Leder	7L6SH083510035A54
ABITIG® 150F	4 m	ED	BSB 35-50 Rundsteckverb. 5-pol.	Standard	7T6FK043510035A54
	8 m	ED	BSB 35-50 Rundsteckverb. 5-pol.	Standard	7T6FK083510035A54
	4 m	ED	BSB 35-50 Rundsteckverb. 5-pol.	High Flex Leder	7T6FH043510035A54
	8 m	ED	BSB 35-50 Rundsteckverb. 5-pol.	High Flex Leder	7T6FH083510035A54
ABITIG® 150F Little	4 m	ED	BSB 35-50 Rundsteckverb. 5-pol.	High Flex Leder	7L6FH043510035A54
	8 m	ED	BSB 35-50 Rundsteckverb. 5-pol.	High Flex Leder	7L6FH083510035A54

ABITIG® GRIP / ABITIG® GRIP Little-Brennerpreisliste

passend für WIG-Stromquellen des Fabrikates „poro-bronze“



Brennertyp	Länge	Schalterfunktion	maschinenseitiger Anschluss	Schlauchpaketausführung	Bestellnummer
ABITIG® 9	4 m	ED/DD	BSB 35-50 Tuchel 5-pol.	Standard	7S1SK043520002A05
	8 m	ED/DD	BSB 35-50 Tuchel 5-pol.	Standard	7S1SK083520002A05
	4 m	ED/DD	BSB 35-50 Tuchel 5-pol.	High Flex Leder	7S1SH043520002A05
	8 m	ED/DD	BSB 35-50 Tuchel 5-pol.	High Flex Leder	7S1SH083520002A05
ABITIG® 9 Little	4 m	ED/DD	BSB 35-50 Tuchel 5-pol.	High Flex Leder	7L1SH043520002A05
	8 m	ED/DD	BSB 35-50 Tuchel 5-pol.	High Flex Leder	7L1SH083520002A05
ABITIG® 9F	4 m	ED/DD	BSB 35-50 Tuchel 5-pol.	Standard	7S1FK043520002A05
	8 m	ED/DD	BSB 35-50 Tuchel 5-pol.	Standard	7S1FK083520002A05
	4 m	ED/DD	BSB 35-50 Tuchel 5-pol.	High Flex Leder	7S1FH043520002A05
	8 m	ED/DD	BSB 35-50 Tuchel 5-pol.	High Flex Leder	7S1FH083520002A05
ABITIG® 9F Little	4 m	ED/DD	BSB 35-50 Tuchel 5-pol.	High Flex Leder	7L1FH043520002A05
	8 m	ED/DD	BSB 35-50 Tuchel 5-pol.	High Flex Leder	7L1FH083520002A05
ABITIG® 17	4 m	ED/DD	BSB 35-50 Tuchel 5-pol.	Standard	7S2SK043520002A05
	8 m	ED/DD	BSB 35-50 Tuchel 5-pol.	Standard	7S2SK083520002A05
	4 m	ED/DD	BSB 35-50 Tuchel 5-pol.	High Flex Leder	7S2SH043520002A05
	8 m	ED/DD	BSB 35-50 Tuchel 5-pol.	High Flex Leder	7S2SH083520002A05
ABITIG® 17 Little	4 m	ED/DD	BSB 35-50 Tuchel 5-pol.	High Flex Leder	7L2SH043520002A05
	8 m	ED/DD	BSB 35-50 Tuchel 5-pol.	High Flex Leder	7L2SH083520002A05
ABITIG® 17F	4 m	ED/DD	BSB 35-50 Tuchel 5-pol.	Standard	7S2FK043520002A05
	8 m	ED/DD	BSB 35-50 Tuchel 5-pol.	Standard	7S2FK083520002A05
	4 m	ED/DD	BSB 35-50 Tuchel 5-pol.	High Flex Leder	7S2FH043520002A05
	8 m	ED/DD	BSB 35-50 Tuchel 5-pol.	High Flex Leder	7S2FH083520002A05
ABITIG® 17F Little	4 m	ED/DD	BSB 35-50 Tuchel 5-pol.	High Flex Leder	7L2FH043520002A05
	8 m	ED/DD	BSB 35-50 Tuchel 5-pol.	High Flex Leder	7L2FH083520002A05

Technische Änderungen vorbehalten • Verkaufspreise = unverbindliche Preisempfehlung - Angebot freibleibend • © Copyright

ABITIG® GRIP / ABITIG® GRIP Little-Brennerpreisliste

passend für WIG-Stromquellen des Fabrikates „poro-bronze“

Brennertyp	Länge	Schalterfunktion	maschinenseitiger Anschluss	Schlauchpaket-ausführung	Bestellnummer
ABITIG® 26	4 m	ED/DD	BSB 35-50 Tuchel 5-pol.	Standard	7S3SK043520002A05
	8 m	ED/DD	BSB 35-50 Tuchel 5-pol.	Standard	7S3SK083520002A05
	4 m	ED/DD	BSB 35-50 Tuchel 5-pol.	High Flex Leder	7S3SH043520002A05
	8 m	ED/DD	BSB 35-50 Tuchel 5-pol.	High Flex Leder	7S3SH083520002A05
ABITIG® 26F	4 m	ED/DD	BSB 35-50 Tuchel 5-pol.	Standard	7S3FK043520002A05
	8 m	ED/DD	BSB 35-50 Tuchel 5-pol.	Standard	7S3FK083520002A05
	4 m	ED/DD	BSB 35-50 Tuchel 5-pol.	High Flex Leder	7S3FH043520002A05
	8 m	ED/DD	BSB 35-50 Tuchel 5-pol.	High Flex Leder	7S3FH083520002A05
ABITIG® 24G	4 m	ED/DD	BSB 35-50 Tuchel 5-pol.	Standard	7S8SK043520002A05
	8 m	ED/DD	BSB 35-50 Tuchel 5-pol.	Standard	7S8SK083520002A05
	4 m	ED/DD	BSB 35-50 Tuchel 5-pol.	High Flex Leder	7S8SH043520002A05
	8 m	ED/DD	BSB 35-50 Tuchel 5-pol.	High Flex Leder	7S8SH083520002A05
ABITIG® 24G Little	4 m	ED/DD	BSB 35-50 Tuchel 5-pol.	High Flex Leder	7L8SH043520002A05
	8 m	ED/DD	BSB 35-50 Tuchel 5-pol.	High Flex Leder	7L8SH083520002A05
ABITIG® 200	4 m	ED/DD	BSB 35-50 Tuchel 5-pol.	Standard	7T4SK043520002A05
	8 m	ED/DD	BSB 35-50 Tuchel 5-pol.	Standard	7T4SK083520002A05
	4 m	ED/DD	BSB 35-50 Tuchel 5-pol.	High Flex Leder	7T4SH043520002A05
	8 m	ED/DD	BSB 35-50 Tuchel 5-pol.	High Flex Leder	7T4SH083520002A05
ABITIG® 200F	4 m	ED/DD	BSB 35-50 Tuchel 5-pol.	Standard	7T4FK043520002A05
	8 m	ED/DD	BSB 35-50 Tuchel 5-pol.	Standard	7T4FK083520002A05
	4 m	ED/DD	BSB 35-50 Tuchel 5-pol.	High Flex Leder	7T4FH043520002A05
	8 m	ED/DD	BSB 35-50 Tuchel 5-pol.	High Flex Leder	7T4FH083520002A05
ABITIG® 150	4 m	ED/DD	BSB 35-50 Tuchel 5-pol.	Standard	7T6SK043520002A05
	8 m	ED/DD	BSB 35-50 Tuchel 5-pol.	Standard	7T6SK083520002A05
	4 m	ED/DD	BSB 35-50 Tuchel 5-pol.	High Flex Leder	7T6SH043520002A05
	8 m	ED/DD	BSB 35-50 Tuchel 5-pol.	High Flex Leder	7T6SH083520002A05
ABITIG® 150 Little	4 m	ED/DD	BSB 35-50 Tuchel 5-pol.	High Flex Leder	7L6SH043520002A05
	8 m	ED/DD	BSB 35-50 Tuchel 5-pol.	High Flex Leder	7L6SH083520002A05
ABITIG® 150F	4 m	ED/DD	BSB 35-50 Tuchel 5-pol.	Standard	7T6FK043520002A05
	8 m	ED/DD	BSB 35-50 Tuchel 5-pol.	Standard	7T6FK083520002A05
	4 m	ED/DD	BSB 35-50 Tuchel 5-pol.	High Flex Leder	7T6FH043520002A05
	8 m	ED/DD	BSB 35-50 Tuchel 5-pol.	High Flex Leder	7T6FH083520002A05
ABITIG® 150F Little	4 m	ED/DD	BSB 35-50 Tuchel 5-pol.	High Flex Leder	7L6FH043520002A05
	8 m	ED/DD	BSB 35-50 Tuchel 5-pol.	High Flex Leder	7L6FH083520002A05

ABITIG® GRIP / ABITIG® GRIP Little-Brennerpreisliste

passend für WIG-Stromquellen des Fabrikates „poro-bronze“

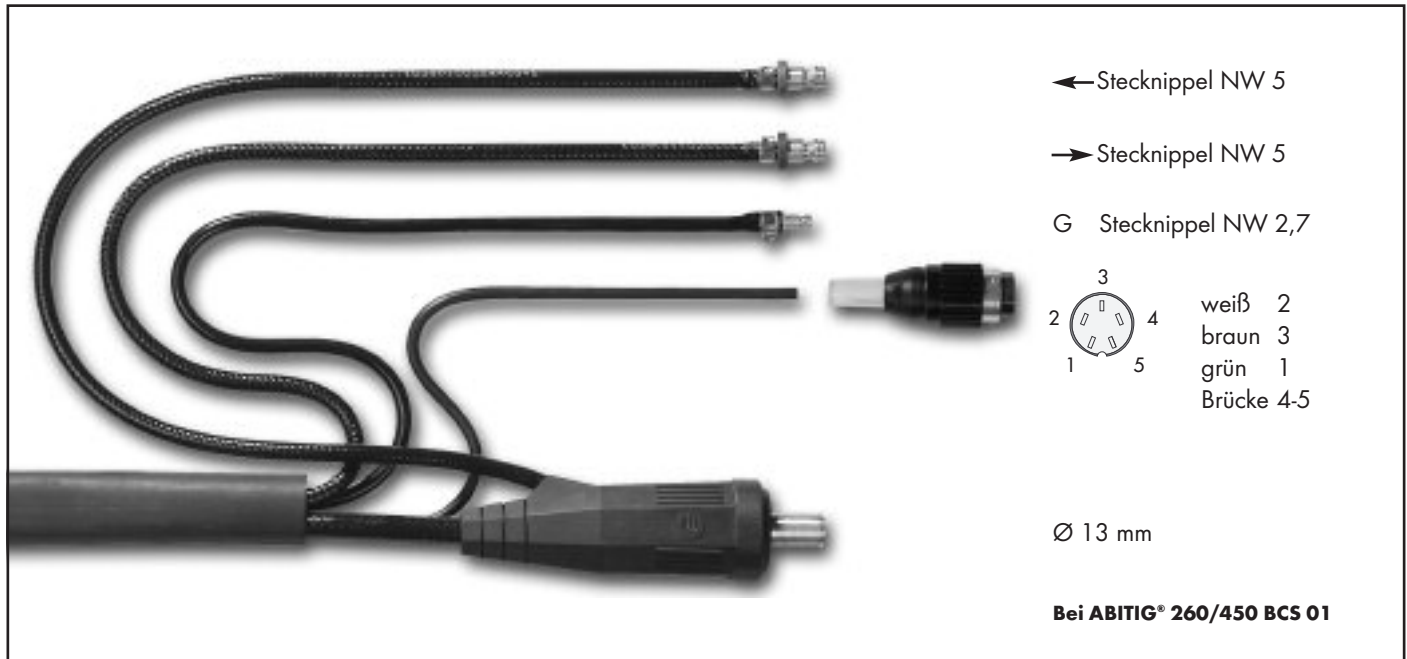

Brennertyp	Länge	Schalterfunktion	maschinenseitiger Anschluss	Schlauchpaketausführung	Bestellnummer
ABITIG® 18	4 m	ED/DD	BSB 35-50 Tuchel 5-pol.	Standard	7S4SK043520002A16
	8 m	ED/DD	BSB 35-50 Tuchel 5-pol.	Standard	7S4SK083520002A16
	4 m	ED/DD	BSB 35-50 Tuchel 5-pol.	High Flex Leder	7S4SH043520002A16
	8 m	ED/DD	BSB 35-50 Tuchel 5-pol.	High Flex Leder	7S4SH083520002A16
ABITIG® 18F	4 m	ED/DD	BSB 35-50 Tuchel 5-pol.	Standard	7S4FK043520002A16
	8 m	ED/DD	BSB 35-50 Tuchel 5-pol.	Standard	7S4FK083520002A16
	4 m	ED/DD	BSB 35-50 Tuchel 5-pol.	High Flex Leder	7S4FH043520002A16
	8 m	ED/DD	BSB 35-50 Tuchel 5-pol.	High Flex Leder	7S4FH083520002A16
ABITIG® 20	4 m	ED/DD	BSB 35-50 Tuchel 5-pol.	Standard	7S5SK043520002A16
	8 m	ED/DD	BSB 35-50 Tuchel 5-pol.	Standard	7S5SK083520002A16
	4 m	ED/DD	BSB 35-50 Tuchel 5-pol.	High Flex Leder	7S5SH043520002A16
	8 m	ED/DD	BSB 35-50 Tuchel 5-pol.	High Flex Leder	7S5SH083520002A16
ABITIG® 20 Little	4 m	ED/DD	BSB 35-50 Tuchel 5-pol.	High Flex Leder	7L5SH043520002A16
	8 m	ED/DD	BSB 35-50 Tuchel 5-pol.	High Flex Leder	7L5SH083520002A16
ABITIG® 20F	4 m	ED/DD	BSB 35-50 Tuchel 5-pol.	Standard	7S5FK043520002A16
	8 m	ED/DD	BSB 35-50 Tuchel 5-pol.	Standard	7S5FK083520002A16
	4 m	ED/DD	BSB 35-50 Tuchel 5-pol.	High Flex Leder	7S5FH043520002A16
	8 m	ED/DD	BSB 35-50 Tuchel 5-pol.	High Flex Leder	7S5FH083520002A16
ABITIG® 20F Little	4 m	ED/DD	BSB 35-50 Tuchel 5-pol.	High Flex Leder	7L5FH043520002A16
	8 m	ED/DD	BSB 35-50 Tuchel 5-pol.	High Flex Leder	7L5FH083520002A16

Technische Änderungen vorbehalten • Verkaufspreise = unverbindliche Preisempfehlung - Angebot freibleibend • © Copyright

ABITIG® GRIP / ABITIG® GRIP Little-Brennerpreisliste

passend für WIG-Stromquellen des Fabrikates „poro-bronze“

Brennertyp	Länge	Schalterfunktion	maschinenseitiger Anschluss	Schlauchpaketausführung	Bestellnummer
ABITIG® 12-1	4 m	ED/DD	BSB 35-50 Tuchel 5-pol.	Standard	7S6SK043520002A16
	8 m	ED/DD	BSB 35-50 Tuchel 5-pol.	Standard	7S6SK083520002A16
	4 m	ED/DD	BSB 35-50 Tuchel 5-pol.	High Flex Leder	7S6SH043520002A16
	8 m	ED/DD	BSB 35-50 Tuchel 5-pol.	High Flex Leder	7S6SH083520002A16
ABITIG® 18SC	4 m	ED/DD	BSB 35-50 Tuchel 5-pol.	Standard	7S7SK043520002A16
	8 m	ED/DD	BSB 35-50 Tuchel 5-pol.	Standard	7S7SK083520002A16
	4 m	ED/DD	BSB 35-50 Tuchel 5-pol.	High Flex Leder	7S7SH043520002A16
	8 m	ED/DD	BSB 35-50 Tuchel 5-pol.	High Flex Leder	7S7SH083520002A16
ABITIG® 24W	4 m	ED/DD	BSB 35-50 Tuchel 5-pol.	Standard	7S9SK043520002A16
	8 m	ED/DD	BSB 35-50 Tuchel 5-pol.	Standard	7S9SK083520002A16
	4 m	ED/DD	BSB 35-50 Tuchel 5-pol.	High Flex Leder	7S9SH043520002A16
	8 m	ED/DD	BSB 35-50 Tuchel 5-pol.	High Flex Leder	7S9SH083520002A16
ABITIG® 24W Little	4 m	ED/DD	BSB 35-50 Tuchel 5-pol.	High Flex Leder	7L9SH043520002A16
	8 m	ED/DD	BSB 35-50 Tuchel 5-pol.	High Flex Leder	7L9SH083520002A16
ABITIG® 450W	4 m	ED/DD	BSB 35-50 Tuchel 5-pol.	Standard	7T5SK043520102A16
	8 m	ED/DD	BSB 35-50 Tuchel 5-pol.	Standard	7T5SK083520102A16
	4 m	ED/DD	BSB 35-50 Tuchel 5-pol.	High Flex Leder	7T5SH043520102A16
	8 m	ED/DD	BSB 35-50 Tuchel 5-pol.	High Flex Leder	7T5SH083520102A16
ABITIG® 260W	4 m	ED/DD	BSB 35-50 Tuchel 5-pol.	Standard	7T7SK043520102A16
	8 m	ED/DD	BSB 35-50 Tuchel 5-pol.	Standard	7T7SK083520102A16
	4 m	ED/DD	BSB 35-50 Tuchel 5-pol.	High Flex Leder	7T7SH043520102A16
	8 m	ED/DD	BSB 35-50 Tuchel 5-pol.	High Flex Leder	7T7SH083520102A16
ABITIG® 260W Little	4 m	ED/DD	BSB 35-50 Tuchel 5-pol.	High Flex Leder	7L7SH043520102A16
	8 m	ED/DD	BSB 35-50 Tuchel 5-pol.	High Flex Leder	7L7SH083520102A16
ABITIG® 450W SC	4 m	ED/DD	BSB 35-50 Tuchel 5-pol.	Standard	
	8 m	ED/DD	BSB 35-50 Tuchel 5-pol.	Standard	
	4 m	ED/DD	BSB 35-50 Tuchel 5-pol.	High Flex Leder	7T8SH043520102A16
	8 m	ED/DD	BSB 35-50 Tuchel 5-pol.	High Flex Leder	7T8SH083520102A16

ABITIG® GRIP / ABITIG® GRIP Little-Brennerpreisliste

passend für WIG-Stromquellen des Fabrikates „rehm“



Brennertyp	Länge	Schalterfunktion	maschinenseitiger Anschluss	Schlauchpaketausführung	Bestellnummer
ABITIG® 9	4 m	ED/DD	BSB 35-50 Rundsteckverbinder 7-pol.	Standard	7S1SK043520012A05
	8 m	ED/DD	BSB 35-50 Rundsteckverbinder 7-pol.	Standard	7S1SK083520012A05
	4 m	ED/DD	BSB 35-50 Rundsteckverbinder 7-pol.	High Flex Leder	7S1SH043520012A05
	8 m	ED/DD	BSB 35-50 Rundsteckverbinder 7-pol.	High Flex Leder	7S1SH083520012A05
ABITIG® 9 Little	4 m	ED/DD	BSB 35-50 Rundsteckverbinder 7-pol.	High Flex Leder	7L1SH043520012A05
	8 m	ED/DD	BSB 35-50 Rundsteckverbinder 7-pol.	High Flex Leder	7L1SH083520012A05
ABITIG® 9F	4 m	ED/DD	BSB 35-50 Rundsteckverbinder 7-pol.	Standard	7S1FK043520012A05
	8 m	ED/DD	BSB 35-50 Rundsteckverbinder 7-pol.	Standard	7S1FK083520012A05
	4 m	ED/DD	BSB 35-50 Rundsteckverbinder 7-pol.	High Flex Leder	7S1FH043520012A05
	8 m	ED/DD	BSB 35-50 Rundsteckverbinder 7-pol.	High Flex Leder	7S1FH083520012A05
ABITIG® 9F Little	4 m	ED/DD	BSB 35-50 Rundsteckverbinder 7-pol.	High Flex Leder	7L1FH043520012A05
	8 m	ED/DD	BSB 35-50 Rundsteckverbinder 7-pol.	High Flex Leder	7L1FH083520012A05
ABITIG® 17	4 m	ED/DD	BSB 35-50 Rundsteckverbinder 7-pol.	Standard	7S2SK043520012A05
	8 m	ED/DD	BSB 35-50 Rundsteckverbinder 7-pol.	Standard	7S2SK083520012A05
	4 m	ED/DD	BSB 35-50 Rundsteckverbinder 7-pol.	High Flex Leder	7S2SH043520012A05
	8 m	ED/DD	BSB 35-50 Rundsteckverbinder 7-pol.	High Flex Leder	7S2SH083520012A05
ABITIG® 17 Little	4 m	ED/DD	BSB 35-50 Rundsteckverbinder 7-pol.	High Flex Leder	7L2SH043520012A05
	8 m	ED/DD	BSB 35-50 Rundsteckverbinder 7-pol.	High Flex Leder	7L2SH083520012A05
ABITIG® 17F	4 m	ED/DD	BSB 35-50 Rundsteckverbinder 7-pol.	Standard	7S2FK043520012A05
	8 m	ED/DD	BSB 35-50 Rundsteckverbinder 7-pol.	Standard	7S2FK083520012A05
	4 m	ED/DD	BSB 35-50 Rundsteckverbinder 7-pol.	High Flex Leder	7S2FH043520012A05
	8 m	ED/DD	BSB 35-50 Rundsteckverbinder 7-pol.	High Flex Leder	7S2FH083520012A05
ABITIG® 17F Little	4 m	ED/DD	BSB 35-50 Rundsteckverbinder 7-pol.	High Flex Leder	7L2FH043520012A05
	8 m	ED/DD	BSB 35-50 Rundsteckverbinder 7-pol.	High Flex Leder	7L2FH083520012A05

Technische Änderungen vorbehalten • Verkaufspreise = unverbindliche Preisempfehlung - Angebot freibleibend • © Copyright

ABITIG® GRIP / ABITIG® GRIP Little-Brennerpreisliste

passend für WIG-Stromquellen des Fabrikates „rehm“

Brennertyp	Länge	Schalterfunktion	maschinenseitiger Anschluss	Schlauchpaketausführung	Bestellnummer
ABITIG® 26	4 m	ED/DD	BSB 35-50 Rundsteckverbinder 7-pol.	Standard	7S3SK043520012A05
	8 m	ED/DD	BSB 35-50 Rundsteckverbinder 7-pol.	Standard	7S3SK083520012A05
	4 m	ED/DD	BSB 35-50 Rundsteckverbinder 7-pol.	High Flex Leder	7S3SH043520012A05
	8 m	ED/DD	BSB 35-50 Rundsteckverbinder 7-pol.	High Flex Leder	7S3SH083520012A05
ABITIG® 26F	4 m	ED/DD	BSB 35-50 Rundsteckverbinder 7-pol.	Standard	7S3FK043520012A05
	8 m	ED/DD	BSB 35-50 Rundsteckverbinder 7-pol.	Standard	7S3FK083520012A05
	4 m	ED/DD	BSB 35-50 Rundsteckverbinder 7-pol.	High Flex Leder	7S3FH043520012A05
	8 m	ED/DD	BSB 35-50 Rundsteckverbinder 7-pol.	High Flex Leder	7S3FH083520012A05
ABITIG® 24G	4 m	ED/DD	BSB 35-50 Rundsteckverbinder 7-pol.	Standard	7S8SK043520012A05
	8 m	ED/DD	BSB 35-50 Rundsteckverbinder 7-pol.	Standard	7S8SK083520012A05
	4 m	ED/DD	BSB 35-50 Rundsteckverbinder 7-pol.	High Flex Leder	7S8SH043520012A05
	8 m	ED/DD	BSB 35-50 Rundsteckverbinder 7-pol.	High Flex Leder	7S8SH083520012A05
ABITIG® 24G Little	4 m	ED/DD	BSB 35-50 Rundsteckverbinder 7-pol.	High Flex Leder	7L8SH043520012A05
	8 m	ED/DD	BSB 35-50 Rundsteckverbinder 7-pol.	High Flex Leder	7L8SH083520012A05
ABITIG® 200	4 m	ED/DD	BSB 35-50 Rundsteckverbinder 7-pol.	Standard	7T4SK043520012A05
	8 m	ED/DD	BSB 35-50 Rundsteckverbinder 7-pol.	Standard	7T4SK083520012A05
	4 m	ED/DD	BSB 35-50 Rundsteckverbinder 7-pol.	High Flex Leder	7T4SH043520012A05
	8 m	ED/DD	BSB 35-50 Rundsteckverbinder 7-pol.	High Flex Leder	7T4SH083520012A05
ABITIG® 200F	4 m	ED/DD	BSB 35-50 Rundsteckverbinder 7-pol.	Standard	7T4FK043520012A05
	8 m	ED/DD	BSB 35-50 Rundsteckverbinder 7-pol.	Standard	7T4FK083520012A05
	4 m	ED/DD	BSB 35-50 Rundsteckverbinder 7-pol.	High Flex Leder	7T4FH043520012A05
	8 m	ED/DD	BSB 35-50 Rundsteckverbinder 7-pol.	High Flex Leder	7T4FH083520012A05
ABITIG® 150	4 m	ED/DD	BSB 35-50 Rundsteckverbinder 7-pol.	Standard	7T6SK043520012A05
	8 m	ED/DD	BSB 35-50 Rundsteckverbinder 7-pol.	Standard	7T6SK083520012A05
	4 m	ED/DD	BSB 35-50 Rundsteckverbinder 7-pol.	High Flex Leder	7T6SH043520012A05
	8 m	ED/DD	BSB 35-50 Rundsteckverbinder 7-pol.	High Flex Leder	7T6SH083520012A05
ABITIG® 150 Little	4 m	ED/DD	BSB 35-50 Rundsteckverbinder 7-pol.	High Flex Leder	7L6SH043520012A05
	8 m	ED/DD	BSB 35-50 Rundsteckverbinder 7-pol.	High Flex Leder	7L6SH083520012A05
ABITIG® 150F	4 m	ED/DD	BSB 35-50 Rundsteckverbinder 7-pol.	Standard	7T6FK043520012A05
	8 m	ED/DD	BSB 35-50 Rundsteckverbinder 7-pol.	Standard	7T6FK083520012A05
	4 m	ED/DD	BSB 35-50 Rundsteckverbinder 7-pol.	High Flex Leder	7T6FH043520012A05
	8 m	ED/DD	BSB 35-50 Rundsteckverbinder 7-pol.	High Flex Leder	7T6FH083520012A05
ABITIG® 150F Little	4 m	ED/DD	BSB 35-50 Rundsteckverbinder 7-pol.	High Flex Leder	7L6FH043520012A05
	8 m	ED/DD	BSB 35-50 Rundsteckverbinder 7-pol.	High Flex Leder	7L6FH083520012A05

ABITIG® GRIP / ABITIG® GRIP Little-Brennerpreisliste

passend für WIG-Stromquellen des Fabrikates „rehm“



Brennertyp	Länge	Schalterfunktion	maschinenseitiger Anschluss	Schlauchpaketausführung	Bestellnummer
ABITIG® 9	4 m	DDP	BSB 35-50 Stecker1) + Stecker2)	Standard	7S1SK046540021A05
	8 m	DDP	BSB 35-50 Stecker1) + Stecker2)	Standard	7S1SK086540021A05
	4 m	DDP	BSB 35-50 Stecker1) + Stecker2)	High Flex Leder	7S1SH046540021A05
	8 m	DDP	BSB 35-50 Stecker1) + Stecker2)	High Flex Leder	7S1SH086540021A05
ABITIG® 9F	4 m	DDP	BSB 35-50 Stecker1) + Stecker2)	Standard	7S1FK046540021A05
	8 m	DDP	BSB 35-50 Stecker1) + Stecker2)	Standard	7S1FK086540021A05
	4 m	DDP	BSB 35-50 Stecker1) + Stecker2)	High Flex Leder	7S1FH046540021A05
	8 m	DDP	BSB 35-50 Stecker1) + Stecker2)	High Flex Leder	7S1FH086540021A05
ABITIG® 17	4 m	DDP	BSB 35-50 Stecker1) + Stecker2)	Standard	7S2SK046540021A05
	8 m	DDP	BSB 35-50 Stecker1) + Stecker2)	Standard	7S2SK086540021A05
	4 m	DDP	BSB 35-50 Stecker1) + Stecker2)	High Flex Leder	7S2SH046540021A05
	8 m	DDP	BSB 35-50 Stecker1) + Stecker2)	High Flex Leder	7S2SH086540021A05
ABITIG® 17F	4 m	DDP	BSB 35-50 Stecker1) + Stecker2)	Standard	7S2FK046540021A05
	8 m	DDP	BSB 35-50 Stecker1) + Stecker2)	Standard	7S2FK086540021A05
	4 m	DDP	BSB 35-50 Stecker1) + Stecker2)	High Flex Leder	7S2FH046540021A05
	8 m	DDP	BSB 35-50 Stecker1) + Stecker2)	High Flex Leder	7S2FH086540021A05

Technische Änderungen vorbehalten • Verkaufspreise = unverbindliche Preisempfehlung - Angebot freibleibend • © Copyright

ABITIG® GRIP / ABITIG® GRIP Little-Brennerpreisliste

passend für WIG-Stromquellen des Fabrikates „rehm“

Brennertyp	Länge	Schalterfunktion	maschinenseitiger Anschluss	Schlauchpaketausführung	Bestellnummer
ABITIG® 26	4 m	DDP	BSB 35-50 Stecker1) + Stecker2)	Standard	7S3SK046540021A05
	8 m	DDP	BSB 35-50 Stecker1) + Stecker2)	Standard	7S3SK086540021A05
	4 m	DDP	BSB 35-50 Stecker1) + Stecker2)	High Flex Leder	7S3SH046540021A05
	8 m	DDP	BSB 35-50 Stecker1) + Stecker2)	High Flex Leder	7S3SH086540021A05
ABITIG® 26F	4 m	DDP	BSB 35-50 Stecker1) + Stecker2)	Standard	7S3FK046540021A05
	8 m	DDP	BSB 35-50 Stecker1) + Stecker2)	Standard	7S3FK086540021A05
	4 m	DDP	BSB 35-50 Stecker1) + Stecker2)	High Flex Leder	7S3FH046540021A05
	8 m	DDP	BSB 35-50 Stecker1) + Stecker2)	High Flex Leder	7S3FH086540021A05
ABITIG® 24G	4 m	DDP	BSB 35-50 Stecker1) + Stecker2)	Standard	7S8SK046540021A05
	8 m	DDP	BSB 35-50 Stecker1) + Stecker2)	Standard	7S8SK086540021A05
	4 m	DDP	BSB 35-50 Stecker1) + Stecker2)	High Flex Leder	7S8SH046540021A05
	8 m	DDP	BSB 35-50 Stecker1) + Stecker2)	High Flex Leder	7S8SH086540021A05
ABITIG® 200	4 m	DDP	BSB 35-50 Stecker1) + Stecker2)	Standard	7T4SK046540021A05
	8 m	DDP	BSB 35-50 Stecker1) + Stecker2)	Standard	7T4SK086540021A05
	4 m	DDP	BSB 35-50 Stecker1) + Stecker2)	High Flex Leder	7T4SH046540021A05
	8 m	DDP	BSB 35-50 Stecker1) + Stecker2)	High Flex Leder	7T4SH086540021A05
ABITIG® 200F	4 m	DDP	BSB 35-50 Stecker1) + Stecker2)	Standard	7T4FK046540021A05
	8 m	DDP	BSB 35-50 Stecker1) + Stecker2)	Standard	7T4FK086540021A05
	4 m	DDP	BSB 35-50 Stecker1) + Stecker2)	High Flex Leder	7T4FH046540021A05
	8 m	DDP	BSB 35-50 Stecker1) + Stecker2)	High Flex Leder	7T4FH086540021A05
ABITIG® 150	4 m	DDP	BSB 35-50 Stecker1) + Stecker2)	Standard	7T6SK046540021A05
	8 m	DDP	BSB 35-50 Stecker1) + Stecker2)	Standard	7T6SK086540021A05
	4 m	DDP	BSB 35-50 Stecker1) + Stecker2)	High Flex Leder	7T6SH046540021A05
	8 m	DDP	BSB 35-50 Stecker1) + Stecker2)	High Flex Leder	7T6SH086540021A05
ABITIG® 150F	4 m	DDP	BSB 35-50 Stecker1) + Stecker2)	Standard	7T6FK046540021A05
	8 m	DDP	BSB 35-50 Stecker1) + Stecker2)	Standard	7T6FK086540021A05
	4 m	DDP	BSB 35-50 Stecker1) + Stecker2)	High Flex Leder	7T6FH046540021A05
	8 m	DDP	BSB 35-50 Stecker1) + Stecker2)	High Flex Leder	7T6FH086540021A05

Stecker¹⁾ = Rundsteckverbinder 7-pol.

Stecker²⁾ = Amphenol 18-pol.

ABITIG® GRIP / ABITIG® GRIP Little-Brennerpreisliste

passend für WIG-Stromquellen des Fabrikates „rehm“

Rehm Tiger B mit Kunststoffgehäuse
Rehm Tiger A mit Blechgehäuse



Stecknippel NW 2,7

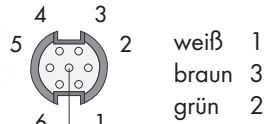

Abschirmung auf PIN 7

Ø 13 mm

Abgeschirmte Steuerleitung

Brennertyp	Länge	Schalterfunktion	maschinenseitiger Anschluss	Schlauchpaketausführung	Bestellnummer
ABITIG® 9	4 m	DD	BSB 35-50 Rundsteckverbinder 7-pol.	Standard	7S1SK047520012A05
	8 m	DD	BSB 35-50 Rundsteckverbinder 7-pol.	Standard	7S1SK087520012A05
	4 m	DD	BSB 35-50 Rundsteckverbinder 7-pol.	High Flex Leder	7S1SH047520012A05
	8 m	DD	BSB 35-50 Rundsteckverbinder 7-pol.	High Flex Leder	7S1SH087520012A05
ABITIG® 9 Little	4 m	DD	BSB 35-50 Rundsteckverbinder 7-pol.	High Flex Leder	7L1SH047520012A05
	8 m	DD	BSB 35-50 Rundsteckverbinder 7-pol.	High Flex Leder	7L1SH087520012A05
ABITIG® 9F	4 m	DD	BSB 35-50 Rundsteckverbinder 7-pol.	Standard	7S1FK047520012A05
	8 m	DD	BSB 35-50 Rundsteckverbinder 7-pol.	Standard	7S1FK087520012A05
	4 m	DD	BSB 35-50 Rundsteckverbinder 7-pol.	High Flex Leder	7S1FH047520012A05
	8 m	DD	BSB 35-50 Rundsteckverbinder 7-pol.	High Flex Leder	7S1FH087520012A05
ABITIG® 9F Little	4 m	DD	BSB 35-50 Rundsteckverbinder 7-pol.	High Flex Leder	7L1FH047520012A05
	8 m	DD	BSB 35-50 Rundsteckverbinder 7-pol.	High Flex Leder	7L1FH087520012A05
ABITIG® 17	4 m	DD	BSB 35-50 Rundsteckverbinder 7-pol.	Standard	7S2SK047520012A05
	8 m	DD	BSB 35-50 Rundsteckverbinder 7-pol.	Standard	7S2SK087520012A05
	4 m	DD	BSB 35-50 Rundsteckverbinder 7-pol.	High Flex Leder	7S2SH047520012A05
	8 m	DD	BSB 35-50 Rundsteckverbinder 7-pol.	High Flex Leder	7S2SH087520012A05
ABITIG® 17 Little	4 m	DD	BSB 35-50 Rundsteckverbinder 7-pol.	High Flex Leder	7L2SH047520012A05
	8 m	DD	BSB 35-50 Rundsteckverbinder 7-pol.	High Flex Leder	7L2SH087520012A05
ABITIG® 17F	4 m	DD	BSB 35-50 Rundsteckverbinder 7-pol.	Standard	7S2FK047520012A05
	8 m	DD	BSB 35-50 Rundsteckverbinder 7-pol.	Standard	7S2FK087520012A05
	4 m	DD	BSB 35-50 Rundsteckverbinder 7-pol.	High Flex Leder	7S2FH047520012A05
	8 m	DD	BSB 35-50 Rundsteckverbinder 7-pol.	High Flex Leder	7S2FH087520012A05
ABITIG® 17F Little	4 m	DD	BSB 35-50 Rundsteckverbinder 7-pol.	High Flex Leder	7L2FH047520012A05
	8 m	DD	BSB 35-50 Rundsteckverbinder 7-pol.	High Flex Leder	7L2FH087520012A05

Technische Änderungen vorbehalten • Verkaufspreise = unverbindliche Preisempfehlung - Angebot freibleibend • © Copyright

ABITIG® GRIP / ABITIG® GRIP Little-Brennerpreisliste

passend für WIG-Stromquellen des Fabrikates „rehm“

Brennertyp	Länge	Schalterfunktion	maschinenseitiger Anschluss	Schlauchpaketausführung	Bestellnummer
ABITIG® 26	4 m	DD	BSB 35-50 Rundsteckverbinder 7-pol.	Standard	7S3SK047520012A05
	8 m	DD	BSB 35-50 Rundsteckverbinder 7-pol.	Standard	7S3SK087520012A05
	4 m	DD	BSB 35-50 Rundsteckverbinder 7-pol.	High Flex Leder	7S3SH047520012A05
	8 m	DD	BSB 35-50 Rundsteckverbinder 7-pol.	High Flex Leder	7S3SH087520012A05
ABITIG® 26F	4 m	DD	BSB 35-50 Rundsteckverbinder 7-pol.	Standard	7S3FK047520012A05
	8 m	DD	BSB 35-50 Rundsteckverbinder 7-pol.	Standard	7S3FK087520012A05
	4 m	DD	BSB 35-50 Rundsteckverbinder 7-pol.	High Flex Leder	7S3FH047520012A05
	8 m	DD	BSB 35-50 Rundsteckverbinder 7-pol.	High Flex Leder	7S3FH087520012A05
ABITIG® 24G	4 m	DD	BSB 35-50 Rundsteckverbinder 7-pol.	Standard	7S8SK047520012A05
	8 m	DD	BSB 35-50 Rundsteckverbinder 7-pol.	Standard	7S8SK087520012A05
	4 m	DD	BSB 35-50 Rundsteckverbinder 7-pol.	High Flex Leder	7S8SH047520012A05
	8 m	DD	BSB 35-50 Rundsteckverbinder 7-pol.	High Flex Leder	7S8SH087520012A05
ABITIG® 24G Little	4 m	DD	BSB 35-50 Rundsteckverbinder 7-pol.	High Flex Leder	7L8SH047520012A05
	8 m	DD	BSB 35-50 Rundsteckverbinder 7-pol.	High Flex Leder	7L8SH087520012A05
ABITIG® 200	4 m	DD	BSB 35-50 Rundsteckverbinder 7-pol.	Standard	7T4SK047520012A05
	8 m	DD	BSB 35-50 Rundsteckverbinder 7-pol.	Standard	7T4SK087520012A05
	4 m	DD	BSB 35-50 Rundsteckverbinder 7-pol.	High Flex Leder	7T4SH047520012A05
	8 m	DD	BSB 35-50 Rundsteckverbinder 7-pol.	High Flex Leder	7T4SH087520012A05
ABITIG® 200F	4 m	DD	BSB 35-50 Rundsteckverbinder 7-pol.	Standard	7T4FK047520012A05
	8 m	DD	BSB 35-50 Rundsteckverbinder 7-pol.	Standard	7T4FK087520012A05
	4 m	DD	BSB 35-50 Rundsteckverbinder 7-pol.	High Flex Leder	7T4FH047520012A05
	8 m	DD	BSB 35-50 Rundsteckverbinder 7-pol.	High Flex Leder	7T4FH087520012A05
ABITIG® 150	4 m	DD	BSB 35-50 Rundsteckverbinder 7-pol.	Standard	7T6SK047520012A05
	8 m	DD	BSB 35-50 Rundsteckverbinder 7-pol.	Standard	7T6SK087520012A05
	4 m	DD	BSB 35-50 Rundsteckverbinder 7-pol.	High Flex Leder	7T6SH047520012A05
	8 m	DD	BSB 35-50 Rundsteckverbinder 7-pol.	High Flex Leder	7T6SH087520012A05
ABITIG® 150 Little	4 m	DD	BSB 35-50 Rundsteckverbinder 7-pol.	High Flex Leder	7L6SH047520012A05
	8 m	DD	BSB 35-50 Rundsteckverbinder 7-pol.	High Flex Leder	7L6SH087520012A05
ABITIG® 150F	4 m	DD	BSB 35-50 Rundsteckverbinder 7-pol.	Standard	7T6FK047520012A05
	8 m	DD	BSB 35-50 Rundsteckverbinder 7-pol.	Standard	7T6FK087520012A05
	4 m	DD	BSB 35-50 Rundsteckverbinder 7-pol.	High Flex Leder	7T6FH047520012A05
	8 m	DD	BSB 35-50 Rundsteckverbinder 7-pol.	High Flex Leder	7T6FH087520012A05
ABITIG® 150F Little	4 m	DD	BSB 35-50 Rundsteckverbinder 7-pol.	High Flex Leder	7L6FH047520012A05
	8 m	DD	BSB 35-50 Rundsteckverbinder 7-pol.	High Flex Leder	7L6FH087520012A05

ABITIG® GRIP / ABITIG® GRIP Little-Brennerpreisliste

passend für WIG-Stromquellen des Fabrikates „rehm“

Rehm Tiger A mit Blechgehäuse



Brennertyp	Länge	Schalterfunktion	maschinenseitiger Anschluss	Schlauchpaketausführung	Bestellnummer
ABITIG® 9	4 m	DDP	BSB 35-50 Stecker1) + Stecker2)	Standard	7S1SK047540021C05
	8 m	DDP	BSB 35-50 Stecker1) + Stecker2)	Standard	7S1SK087540021C05
	4 m	DDP	BSB 35-50 Stecker1) + Stecker2)	High Flex Leder	7S1SH047540021C05
	8 m	DDP	BSB 35-50 Stecker1) + Stecker2)	High Flex Leder	7S1SH087540021C05
ABITIG® 9F	4 m	DDP	BSB 35-50 Stecker1) + Stecker2)	Standard	7S1FK047540021C05
	8 m	DDP	BSB 35-50 Stecker1) + Stecker2)	Standard	7S1FK087540021C05
	4 m	DDP	BSB 35-50 Stecker1) + Stecker2)	High Flex Leder	7S1FH047540021C05
	8 m	DDP	BSB 35-50 Stecker1) + Stecker2)	High Flex Leder	7S1FH087540021C05
ABITIG® 17	4 m	DDP	BSB 35-50 Stecker1) + Stecker2)	Standard	7S2SK047540021C05
	8 m	DDP	BSB 35-50 Stecker1) + Stecker2)	Standard	7S2SK087540021C05
	4 m	DDP	BSB 35-50 Stecker1) + Stecker2)	High Flex Leder	7S2SH047540021C05
	8 m	DDP	BSB 35-50 Stecker1) + Stecker2)	High Flex Leder	7S2SH087540021C05
ABITIG® 17F	4 m	DDP	BSB 35-50 Stecker1) + Stecker2)	Standard	7S2FK047540021C05
	8 m	DDP	BSB 35-50 Stecker1) + Stecker2)	Standard	7S2FK087540021C05
	4 m	DDP	BSB 35-50 Stecker1) + Stecker2)	High Flex Leder	7S2FH047540021C05
	8 m	DDP	BSB 35-50 Stecker1) + Stecker2)	High Flex Leder	7S2FH087540021C05

Technische Änderungen vorbehalten • Verkaufspreise = unverbindliche Preisempfehlung - Angebot freibleibend • © Copyright

ABITIG® GRIP / ABITIG® GRIP Little-Brennerpreisliste

passend für WIG-Stromquellen des Fabrikates „rehm“

Brennertyp	Länge	Schalterfunktion	maschinenseitiger Anschluss	Schlauchpaketausführung	Bestellnummer
ABITIG® 26	4 m	DDP	BSB 35-50 Stecker1) + Stecker2)	Standard	7S3SK047540021C05
	8 m	DDP	BSB 35-50 Stecker1) + Stecker2)	Standard	7S3SK087540021C05
	4 m	DDP	BSB 35-50 Stecker1) + Stecker2)	High Flex Leder	7S3SH047540021C05
	8 m	DDP	BSB 35-50 Stecker1) + Stecker2)	High Flex Leder	7S3SH087540021C05
ABITIG® 26F	4 m	DDP	BSB 35-50 Stecker1) + Stecker2)	Standard	7S3FK047540021C05
	8 m	DDP	BSB 35-50 Stecker1) + Stecker2)	Standard	7S3FK087540021C05
	4 m	DDP	BSB 35-50 Stecker1) + Stecker2)	High Flex Leder	7S3FH047540021C05
	8 m	DDP	BSB 35-50 Stecker1) + Stecker2)	High Flex Leder	7S3FH087540021C05
ABITIG® 24G	4 m	DDP	BSB 35-50 Stecker1) + Stecker2)	Standard	7S8SK047540021C05
	8 m	DDP	BSB 35-50 Stecker1) + Stecker2)	Standard	7S8SK087540021C05
	4 m	DDP	BSB 35-50 Stecker1) + Stecker2)	High Flex Leder	7S8SH047540021C05
	8 m	DDP	BSB 35-50 Stecker1) + Stecker2)	High Flex Leder	7S8SH087540021C05
ABITIG® 200	4 m	DDP	BSB 35-50 Stecker1) + Stecker2)	Standard	7T4SK047540021C05
	8 m	DDP	BSB 35-50 Stecker1) + Stecker2)	Standard	7T4SK087540021C05
	4 m	DDP	BSB 35-50 Stecker1) + Stecker2)	High Flex Leder	7T4SH047540021C05
	8 m	DDP	BSB 35-50 Stecker1) + Stecker2)	High Flex Leder	7T4SH087540021C05
ABITIG® 200F	4 m	DDP	BSB 35-50 Stecker1) + Stecker2)	Standard	7T4FK047540021C05
	8 m	DDP	BSB 35-50 Stecker1) + Stecker2)	Standard	7T4FK087540021C05
	4 m	DDP	BSB 35-50 Stecker1) + Stecker2)	High Flex Leder	7T4FH047540021C05
	8 m	DDP	BSB 35-50 Stecker1) + Stecker2)	High Flex Leder	7T4FH087540021C05
ABITIG® 150	4 m	DDP	BSB 35-50 Stecker1) + Stecker2)	Standard	7T6SK047540021C05
	8 m	DDP	BSB 35-50 Stecker1) + Stecker2)	Standard	7T6SK087540021C05
	4 m	DDP	BSB 35-50 Stecker1) + Stecker2)	High Flex Leder	7T6SH047540021C05
	8 m	DDP	BSB 35-50 Stecker1) + Stecker2)	High Flex Leder	7T6SH087540021C05
ABITIG® 150F	4 m	DDP	BSB 35-50 Stecker1) + Stecker2)	Standard	7T6FK047540021C05
	8 m	DDP	BSB 35-50 Stecker1) + Stecker2)	Standard	7T6FK087540021C05
	4 m	DDP	BSB 35-50 Stecker1) + Stecker2)	High Flex Leder	7T6FH047540021C05
	8 m	DDP	BSB 35-50 Stecker1) + Stecker2)	High Flex Leder	7T6FH087540021C05

Stecker¹⁾ = Rundsteckverbinder 7-pol.

Stecker²⁾ = Amphenol 18-pol.

ABITIG® GRIP / ABITIG® GRIP Little-Brennerpreisliste

passend für WIG-Stromquellen des Fabrikates „rehm“

Nur Rehm Tiger B mit Kunststoffgehäuse



Stecknippel NW 2,7

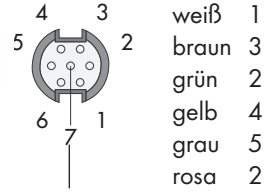

Abschirmung auf PIN 7

Ø 13 mm

Brennertyp	Länge	Schalterfunktion	maschinenseitiger Anschluss	Schlauchpaketausführung	Bestellnummer
ABITIG® 9	4 m	DDP	BSB 35-50 Rundsteckverbinder 7-pol.	Standard	7S1SK047540021D05
	8 m	DDP	BSB 35-50 Rundsteckverbinder 7-pol.	Standard	7S1SK087540021D05
	4 m	DDP	BSB 35-50 Rundsteckverbinder 7-pol.	High Flex Leder	7S1SH047540021D05
	8 m	DDP	BSB 35-50 Rundsteckverbinder 7-pol.	High Flex Leder	7S1SH087540021D05
ABITIG® 9F	4 m	DDP	BSB 35-50 Rundsteckverbinder 7-pol.	Standard	7S1FK047540021D05
	8 m	DDP	BSB 35-50 Rundsteckverbinder 7-pol.	Standard	7S1FK087540021D05
	4 m	DDP	BSB 35-50 Rundsteckverbinder 7-pol.	High Flex Leder	7S1FH047540021D05
	8 m	DDP	BSB 35-50 Rundsteckverbinder 7-pol.	High Flex Leder	7S1FH087540021D05
ABITIG® 17	4 m	DDP	BSB 35-50 Rundsteckverbinder 7-pol.	Standard	7S2SK047540021D05
	8 m	DDP	BSB 35-50 Rundsteckverbinder 7-pol.	Standard	7S2SK087540021D05
	4 m	DDP	BSB 35-50 Rundsteckverbinder 7-pol.	High Flex Leder	7S2SH047540021D05
	8 m	DDP	BSB 35-50 Rundsteckverbinder 7-pol.	High Flex Leder	7S2SH087540021D05
ABITIG® 17F	4 m	DDP	BSB 35-50 Rundsteckverbinder 7-pol.	Standard	7S2FK047540021D05
	8 m	DDP	BSB 35-50 Rundsteckverbinder 7-pol.	Standard	7S2FK087540021D05
	4 m	DDP	BSB 35-50 Rundsteckverbinder 7-pol.	High Flex Leder	7S2FH047540021D05
	8 m	DDP	BSB 35-50 Rundsteckverbinder 7-pol.	High Flex Leder	7S2FH087540021D05

Technische Änderungen vorbehalten • Verkaufspreise = unverbindliche Preisempfehlung - Angebot freibleibend • © Copyright

ABITIG® GRIP / ABITIG® GRIP Little-Brennerpreisliste

passend für WIG-Stromquellen des Fabrikates „rehm“

Brennertyp	Länge	Schalterfunktion	maschinenseitiger Anschluss	Schlauchpaketausführung	Bestellnummer
ABITIG® 26	4 m	DDP	BSB 35-50 Rundsteckverbinder 7-pol.	Standard	7S3SK047540021D05
	8 m	DDP	BSB 35-50 Rundsteckverbinder 7-pol.	Standard	7S3SK087540021D05
	4 m	DDP	BSB 35-50 Rundsteckverbinder 7-pol.	High Flex Leder	7S3SH047540021D05
	8 m	DDP	BSB 35-50 Rundsteckverbinder 7-pol.	High Flex Leder	7S3SH087540021D05
ABITIG® 26F	4 m	DDP	BSB 35-50 Rundsteckverbinder 7-pol.	Standard	7S3FK047540021D05
	8 m	DDP	BSB 35-50 Rundsteckverbinder 7-pol.	Standard	7S3FK087540021D05
	4 m	DDP	BSB 35-50 Rundsteckverbinder 7-pol.	High Flex Leder	7S3FH047540021D05
	8 m	DDP	BSB 35-50 Rundsteckverbinder 7-pol.	High Flex Leder	7S3FH087540021D05
ABITIG® 24G	4 m	DDP	BSB 35-50 Rundsteckverbinder 7-pol.	Standard	7S8SK047540021D05
	8 m	DDP	BSB 35-50 Rundsteckverbinder 7-pol.	Standard	7S8SK087540021D05
	4 m	DDP	BSB 35-50 Rundsteckverbinder 7-pol.	High Flex Leder	7S8SH047540021D05
	8 m	DDP	BSB 35-50 Rundsteckverbinder 7-pol.	High Flex Leder	7S8SH087540021D05
ABITIG® 200	4 m	DDP	BSB 35-50 Rundsteckverbinder 7-pol.	Standard	7T4SK047540021D05
	8 m	DDP	BSB 35-50 Rundsteckverbinder 7-pol.	Standard	7T4SK087540021D05
	4 m	DDP	BSB 35-50 Rundsteckverbinder 7-pol.	High Flex Leder	7T4SH047540021D05
	8 m	DDP	BSB 35-50 Rundsteckverbinder 7-pol.	High Flex Leder	7T4SH087540021D05
ABITIG® 200F	4 m	DDP	BSB 35-50 Rundsteckverbinder 7-pol.	Standard	7T4FK047540021D05
	8 m	DDP	BSB 35-50 Rundsteckverbinder 7-pol.	Standard	7T4FK087540021D05
	4 m	DDP	BSB 35-50 Rundsteckverbinder 7-pol.	High Flex Leder	7T4FH047540021D05
	8 m	DDP	BSB 35-50 Rundsteckverbinder 7-pol.	High Flex Leder	7T4FH087540021D05
ABITIG® 150	4 m	DDP	BSB 35-50 Rundsteckverbinder 7-pol.	Standard	7T6SK047540021D05
	8 m	DDP	BSB 35-50 Rundsteckverbinder 7-pol.	Standard	7T6SK087540021D05
	4 m	DDP	BSB 35-50 Rundsteckverbinder 7-pol.	High Flex Leder	7T6SH047540021D05
	8 m	DDP	BSB 35-50 Rundsteckverbinder 7-pol.	High Flex Leder	7T6SH087540021D05
ABITIG® 150F	4 m	DDP	BSB 35-50 Rundsteckverbinder 7-pol.	Standard	7T6FK047540021D05
	8 m	DDP	BSB 35-50 Rundsteckverbinder 7-pol.	Standard	7T6FK087540021D05
	4 m	DDP	BSB 35-50 Rundsteckverbinder 7-pol.	High Flex Leder	7T6FH047540021D05
	8 m	DDP	BSB 35-50 Rundsteckverbinder 7-pol.	High Flex Leder	7T6FH087540021D05

ABITIG® GRIP / ABITIG® GRIP Little-Brennerpreisliste

passend für WIG-Stromquellen des Fabrikates „rehm“



Brennertyp	Länge	Schalterfunktion	maschinenseitiger Anschluss	Schlauchpaketausführung	Bestellnummer
ABITIG® 18	4 m	ED/DD	BSB 35-50 Rundsteckverbinder 7-pol.	Standard	7S4SK043520003A16
	8 m	ED/DD	BSB 35-50 Rundsteckverbinder 7-pol.	Standard	7S4SK083520003A16
	4 m	ED/DD	BSB 35-50 Rundsteckverbinder 7-pol.	High Flex Leder	7S4SH043520003A16
	8 m	ED/DD	BSB 35-50 Rundsteckverbinder 7-pol.	High Flex Leder	7S4SH083520003A16
ABITIG® 18F	4 m	ED/DD	BSB 35-50 Rundsteckverbinder 7-pol.	Standard	7S4FK043520003A16
	8 m	ED/DD	BSB 35-50 Rundsteckverbinder 7-pol.	Standard	7S4FK083520003A16
	4 m	ED/DD	BSB 35-50 Rundsteckverbinder 7-pol.	High Flex Leder	7S4FH043520003A16
	8 m	ED/DD	BSB 35-50 Rundsteckverbinder 7-pol.	High Flex Leder	7S4FH083520003A16
ABITIG® 20	4 m	ED/DD	BSB 35-50 Rundsteckverbinder 7-pol.	Standard	7S5SK043520003A16
	8 m	ED/DD	BSB 35-50 Rundsteckverbinder 7-pol.	Standard	7S5SK083520003A16
	4 m	ED/DD	BSB 35-50 Rundsteckverbinder 7-pol.	High Flex Leder	7S5SH043520003A16
	8 m	ED/DD	BSB 35-50 Rundsteckverbinder 7-pol.	High Flex Leder	7S5SH083520003A16
ABITIG® 20 Little	4 m	ED/DD	BSB 35-50 Rundsteckverbinder 7-pol.	High Flex Leder	7L5SH043520003A16
	8 m	ED/DD	BSB 35-50 Rundsteckverbinder 7-pol.	High Flex Leder	7L5SH083520003A16
ABITIG® 20F	4 m	ED/DD	BSB 35-50 Rundsteckverbinder 7-pol.	Standard	7S5FK043520003A16
	8 m	ED/DD	BSB 35-50 Rundsteckverbinder 7-pol.	Standard	7S5FK083520003A16
	4 m	ED/DD	BSB 35-50 Rundsteckverbinder 7-pol.	High Flex Leder	7S5FH043520003A16
	8 m	ED/DD	BSB 35-50 Rundsteckverbinder 7-pol.	High Flex Leder	7S5FH083520003A16
ABITIG® 20F Little	4 m	ED/DD	BSB 35-50 Rundsteckverbinder 7-pol.	High Flex Leder	7L5FH043520003A16
	8 m	ED/DD	BSB 35-50 Rundsteckverbinder 7-pol.	High Flex Leder	7L5FH083520003A16

Technische Änderungen vorbehalten • Verkaufspreise = unverbindliche Preisempfehlung - Angebot freibleibend • © Copyright

ABITIG® GRIP / ABITIG® GRIP Little-Brennerpreisliste

passend für WIG-Stromquellen des Fabrikates „rehm“

Brennertyp	Länge	Schalterfunktion	maschinenseitiger Anschluss	Schlauchpaketausführung	Bestellnummer
ABITIG® 12-1	4 m	ED/DD	BSB 35-50 Rundsteckverbinder 7-pol.	Standard	7S6SK043520003A16
	8 m	ED/DD	BSB 35-50 Rundsteckverbinder 7-pol.	Standard	7S6SK083520003A16
	4 m	ED/DD	BSB 35-50 Rundsteckverbinder 7-pol.	High Flex Leder	7S6SH043520003A16
	8 m	ED/DD	BSB 35-50 Rundsteckverbinder 7-pol.	High Flex Leder	7S6SH083520003A16
ABITIG® 18SC	4 m	ED/DD	BSB 35-50 Rundsteckverbinder 7-pol.	Standard	7S7SK043520003A16
	8 m	ED/DD	BSB 35-50 Rundsteckverbinder 7-pol.	Standard	7S7SK083520003A16
	4 m	ED/DD	BSB 35-50 Rundsteckverbinder 7-pol.	High Flex Leder	7S7SH043520003A16
	8 m	ED/DD	BSB 35-50 Rundsteckverbinder 7-pol.	High Flex Leder	7S7SH083520003A16
ABITIG® 24W	4 m	ED/DD	BSB 35-50 Rundsteckverbinder 7-pol.	Standard	7S9SK043520003A16
	8 m	ED/DD	BSB 35-50 Rundsteckverbinder 7-pol.	Standard	7S9SK083520003A16
	4 m	ED/DD	BSB 35-50 Rundsteckverbinder 7-pol.	High Flex Leder	7S9SH043520003A16
	8 m	ED/DD	BSB 35-50 Rundsteckverbinder 7-pol.	High Flex Leder	7S9SH083520003A16
ABITIG® 24W Little	4 m	ED/DD	BSB 35-50 Rundsteckverbinder 7-pol.	High Flex Leder	7L9SH043520003A16
	8 m	ED/DD	BSB 35-50 Rundsteckverbinder 7-pol.	High Flex Leder	7L9SH083520003A16
ABITIG® 450W	4 m	ED/DD	BSB 35-50 Rundsteckverbinder 7-pol.	Standard	7T5SK043520103A16
	8 m	ED/DD	BSB 35-50 Rundsteckverbinder 7-pol.	Standard	7T5SK083520103A16
	4 m	ED/DD	BSB 35-50 Rundsteckverbinder 7-pol.	High Flex Leder	7T5SH043520103A16
	8 m	ED/DD	BSB 35-50 Rundsteckverbinder 7-pol.	High Flex Leder	7T5SH083520103A16
ABITIG® 260W	4 m	ED/DD	BSB 35-50 Rundsteckverbinder 7-pol.	Standard	7T7SK043520103A16
	8 m	ED/DD	BSB 35-50 Rundsteckverbinder 7-pol.	Standard	7T7SK083520103A16
	4 m	ED/DD	BSB 35-50 Rundsteckverbinder 7-pol.	High Flex Leder	7T7SH043520103A16
	8 m	ED/DD	BSB 35-50 Rundsteckverbinder 7-pol.	High Flex Leder	7T7SH083520103A16
ABITIG® 260W Little	4 m	ED/DD	BSB 35-50 Rundsteckverbinder 7-pol.	High Flex Leder	7L7SH043520103A16
	8 m	ED/DD	BSB 35-50 Rundsteckverbinder 7-pol.	High Flex Leder	7L7SH083520103A16
ABITIG® 450W SC	4 m	ED/DD	BSB 35-50 Rundsteckverbinder 7-pol.	Standard	
	8 m	ED/DD	BSB 35-50 Rundsteckverbinder 7-pol.	Standard	
	4 m	ED/DD	BSB 35-50 Rundsteckverbinder 7-pol.	High Flex Leder	7T8SH043520103A16
	8 m	ED/DD	BSB 35-50 Rundsteckverbinder 7-pol.	High Flex Leder	7T8SH083520103A16

ABITIG® GRIP / ABITIG® GRIP Little-Brennerpreisliste

passend für WIG-Stromquellen des Fabrikates „rehm“

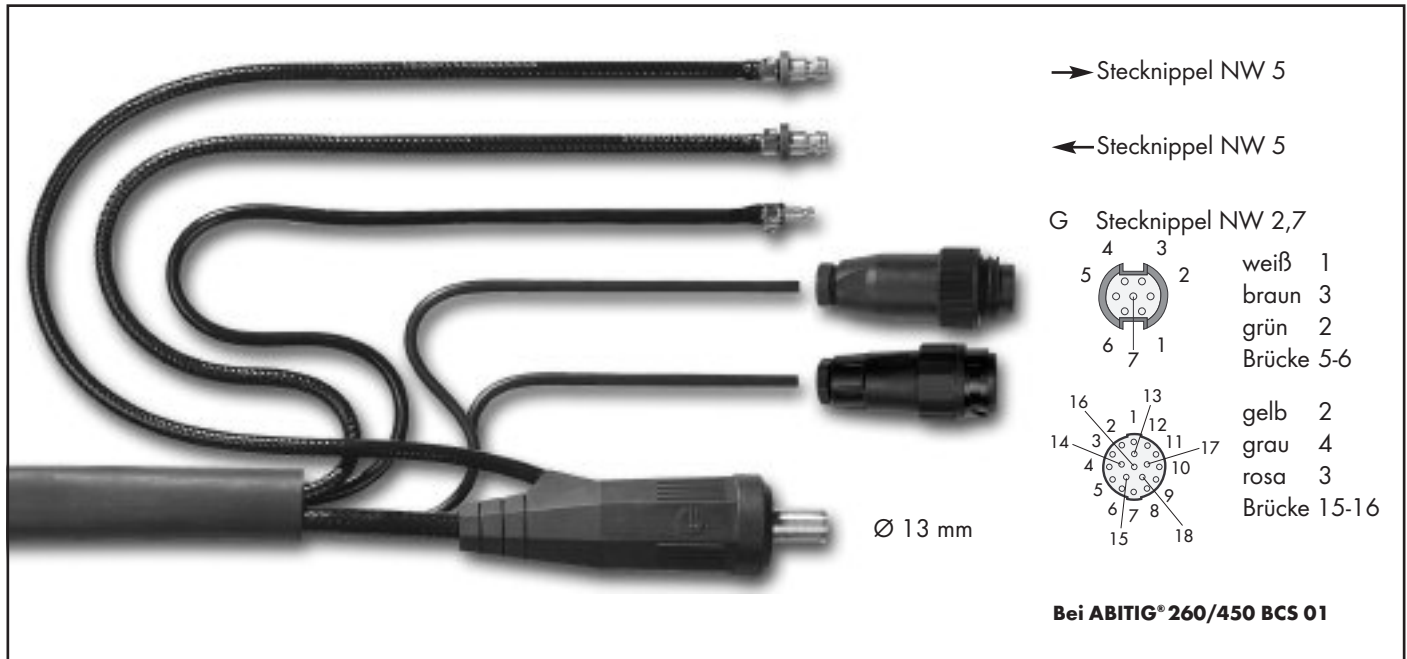

Brennertyp	Länge	Schalterfunktion	maschinenseitiger Anschluss	Schlauchpaketausführung	Bestellnummer
ABITIG® 18	4 m	DDP	BSB 35-50 Stecker1) + Stecker2)	Standard	7S4SK046540021B16
	8 m	DDP	BSB 35-50 Stecker1) + Stecker2)	Standard	7S4SK086540021B16
	4 m	DDP	BSB 35-50 Stecker1) + Stecker2)	High Flex Leder	7S4SH046540021B16
	8 m	DDP	BSB 35-50 Stecker1) + Stecker2)	High Flex Leder	7S4SH086540021B16
ABITIG® 18F	4 m	DDP	BSB 35-50 Stecker1) + Stecker2)	Standard	7S4FK046540021B16
	8 m	DDP	BSB 35-50 Stecker1) + Stecker2)	Standard	7S4FK086540021B16
	4 m	DDP	BSB 35-50 Stecker1) + Stecker2)	High Flex Leder	7S4FH046540021B16
	8 m	DDP	BSB 35-50 Stecker1) + Stecker2)	High Flex Leder	7S4FH086540021B16
ABITIG® 20	4 m	DDP	BSB 35-50 Stecker1) + Stecker2)	Standard	7S5SK046540021B16
	8 m	DDP	BSB 35-50 Stecker1) + Stecker2)	Standard	7S5SK086540021B16
	4 m	DDP	BSB 35-50 Stecker1) + Stecker2)	High Flex Leder	7S5SH046540021B16
	8 m	DDP	BSB 35-50 Stecker1) + Stecker2)	High Flex Leder	7S5SH086540021B16
ABITIG® 20F	4 m	DDP	BSB 35-50 Stecker1) + Stecker2)	Standard	7S5FK046540021B16
	8 m	DDP	BSB 35-50 Stecker1) + Stecker2)	Standard	7S5FK086540021B16
	4 m	DDP	BSB 35-50 Stecker1) + Stecker2)	High Flex Leder	7S5FH046540021B16
	8 m	DDP	BSB 35-50 Stecker1) + Stecker2)	High Flex Leder	7S5FH086540021B16

Technische Änderungen vorbehalten • Verkaufspreise = unverbindliche Preisempfehlung - Angebot freibleibend • © Copyright

ABITIG® GRIP / ABITIG® GRIP Little-Brennerpreisliste

passend für WIG-Stromquellen des Fabrikates „rehm“

Brennertyp	Länge	Schalterfunktion	maschinenseitiger Anschluss	Schlauchpaketausführung	Bestellnummer
ABITIG® 12-1	4 m	DDP	BSB 35-50 Stecker1) + Stecker2)	Standard	7S6SK046540021B16
	8 m	DDP	BSB 35-50 Stecker1) + Stecker2)	Standard	7S6SK086540021B16
	4 m	DDP	BSB 35-50 Stecker1) + Stecker2)	High Flex Leder	7S6SH046540021B16
	8 m	DDP	BSB 35-50 Stecker1) + Stecker2)	High Flex Leder	7S6SH086540021B16
ABITIG® 18SC	4 m	DDP	BSB 35-50 Stecker1) + Stecker2)	Standard	7S7SK046540021B16
	8 m	DDP	BSB 35-50 Stecker1) + Stecker2)	Standard	7S7SK086540021B16
	4 m	DDP	BSB 35-50 Stecker1) + Stecker2)	High Flex Leder	7S7SH046540021B16
	8 m	DDP	BSB 35-50 Stecker1) + Stecker2)	High Flex Leder	7S7SH086540021B16
ABITIG® 24W	4 m	DDP	BSB 35-50 Stecker1) + Stecker2)	Standard	7S9SK046540021B16
	8 m	DDP	BSB 35-50 Stecker1) + Stecker2)	Standard	7S9SK086540021B16
	4 m	DDP	BSB 35-50 Stecker1) + Stecker2)	High Flex Leder	7S9SH046540021B16
	8 m	DDP	BSB 35-50 Stecker1) + Stecker2)	High Flex Leder	7S9SH086540021B16
ABITIG® 450W	4 m	DDP	BSB 35-50 Stecker1) + Stecker2)	Standard	7T5SK046540121B16
	8 m	DDP	BSB 35-50 Stecker1) + Stecker2)	Standard	7T5SK086540121B16
	4 m	DDP	BSB 35-50 Stecker1) + Stecker2)	High Flex Leder	7T5SH046540121B16
	8 m	DDP	BSB 35-50 Stecker1) + Stecker2)	High Flex Leder	7T5SH086540121B16
ABITIG® 260W	4 m	DDP	BSB 35-50 Stecker1) + Stecker2)	Standard	7T7SK046540121B16
	8 m	DDP	BSB 35-50 Stecker1) + Stecker2)	Standard	7T7SK086540121B16
	4 m	DDP	BSB 35-50 Stecker1) + Stecker2)	High Flex Leder	7T7SH046540121B16
	8 m	DDP	BSB 35-50 Stecker1) + Stecker2)	High Flex Leder	7T7SH086540121B16
ABITIG® 450W SC	4 m	DDP	BSB 35-50 Stecker1) + Stecker2)	Standard	
	8 m	DDP	BSB 35-50 Stecker1) + Stecker2)	Standard	
	4 m	DDP	BSB 35-50 Stecker1) + Stecker2)	High Flex Leder	7T8SH046540121B16
	8 m	DDP	BSB 35-50 Stecker1) + Stecker2)	High Flex Leder	7T8SH086540121B16

Stecker¹⁾ = Rundsteckverbinder 7-pol.

Stecker²⁾ = Amphenol 18-pol.

ABITIG® GRIP / ABITIG® GRIP Little-Brennerpreisliste

passend für WIG-Stromquellen des Fabrikates „röwac“



Brennertyp	Länge	Schalterfunktion	maschinenseitiger Anschluss	Schlauchpaketausführung	Bestellnummer
ABITIG® 9	4 m	ED	ZA - GZ Tuchel 5-pol.	Standard	7S1SK043510305A00
	8 m	ED	ZA - GZ Tuchel 5-pol.	Standard	7S1SK083510305A00
	4 m	ED	ZA - GZ Tuchel 5-pol.	High Flex Leder	7S1SH043510305A00
	8 m	ED	ZA - GZ Tuchel 5-pol.	High Flex Leder	7S1SH083510305A00
ABITIG® 9 Little	4 m	ED	ZA - GZ Tuchel 5-pol.	High Flex Leder	7L1SH043510305A00
	8 m	ED	ZA - GZ Tuchel 5-pol.	High Flex Leder	7L1SH083510305A00
ABITIG® 9F	4 m	ED	ZA - GZ Tuchel 5-pol.	Standard	7S1FK043510305A00
	8 m	ED	ZA - GZ Tuchel 5-pol.	Standard	7S1FK083510305A00
	4 m	ED	ZA - GZ Tuchel 5-pol.	High Flex Leder	7S1FH043510305A00
	8 m	ED	ZA - GZ Tuchel 5-pol.	High Flex Leder	7S1FH083510305A00
ABITIG® 9F Little	4 m	ED	ZA - GZ Tuchel 5-pol.	High Flex Leder	7L1FH043510305A00
	8 m	ED	ZA - GZ Tuchel 5-pol.	High Flex Leder	7L1FH083510305A00
ABITIG® 17	4 m	ED	ZA - GZ Tuchel 5-pol.	Standard	7S2SK043510305A00
	8 m	ED	ZA - GZ Tuchel 5-pol.	Standard	7S2SK083510305A00
	4 m	ED	ZA - GZ Tuchel 5-pol.	High Flex Leder	7S2SH043510305A00
	8 m	ED	ZA - GZ Tuchel 5-pol.	High Flex Leder	7S2SH083510305A00
ABITIG® 17 Little	4 m	ED	ZA - GZ Tuchel 5-pol.	High Flex Leder	7L2SH043510305A00
	8 m	ED	ZA - GZ Tuchel 5-pol.	High Flex Leder	7L2SH083510305A00
ABITIG® 17F	4 m	ED	ZA - GZ Tuchel 5-pol.	Standard	7S2FK043510305A00
	8 m	ED	ZA - GZ Tuchel 5-pol.	Standard	7S2FK083510305A00
	4 m	ED	ZA - GZ Tuchel 5-pol.	High Flex Leder	7S2FH043510305A00
	8 m	ED	ZA - GZ Tuchel 5-pol.	High Flex Leder	7S2FH083510305A00
ABITIG® 17F Little	4 m	ED	ZA - GZ Tuchel 5-pol.	High Flex Leder	7L2FH043510305A00
	8 m	ED	ZA - GZ Tuchel 5-pol.	High Flex Leder	7L2FH083510305A00

Technische Änderungen vorbehalten • Verkaufspreise = unverbindliche Preisempfehlung - Angebot freibleibend • © Copyright

ABITIG® GRIP / ABITIG® GRIP Little-Brennerpreisliste

passend für WIG-Stromquellen des Fabrikates „röwac“

Brennertyp	Länge	Schalterfunktion	maschinenseitiger Anschluss	Schlauchpaketausführung	Bestellnummer
ABITIG® 26	4 m	ED	ZA - GZ Tuchel 5-pol.	Standard	7S3SK043510305A00
	8 m	ED	ZA - GZ Tuchel 5-pol.	Standard	7S3SK083510305A00
	4 m	ED	ZA - GZ Tuchel 5-pol.	High Flex Leder	7S3SH043510305A00
	8 m	ED	ZA - GZ Tuchel 5-pol.	High Flex Leder	7S3SH083510305A00
ABITIG® 26F	4 m	ED	ZA - GZ Tuchel 5-pol.	Standard	7S3FK043510305A00
	8 m	ED	ZA - GZ Tuchel 5-pol.	Standard	7S3FK083510305A00
	4 m	ED	ZA - GZ Tuchel 5-pol.	High Flex Leder	7S3FH043510305A00
	8 m	ED	ZA - GZ Tuchel 5-pol.	High Flex Leder	7S3FH083510305A00
ABITIG® 24G	4 m	ED	ZA - GZ Tuchel 5-pol.	Standard	7S8SK043510305A00
	8 m	ED	ZA - GZ Tuchel 5-pol.	Standard	7S8SK083510305A00
	4 m	ED	ZA - GZ Tuchel 5-pol.	High Flex Leder	7S8SH043510305A00
	8 m	ED	ZA - GZ Tuchel 5-pol.	High Flex Leder	7S8SH083510305A00
ABITIG® 24G Little	4 m	ED	ZA - GZ Tuchel 5-pol.	High Flex Leder	7L8SH043510305A00
	8 m	ED	ZA - GZ Tuchel 5-pol.	High Flex Leder	7L8SH083510305A00
ABITIG® 200	4 m	ED	ZA - GZ Tuchel 5-pol.	Standard	7T4SK043510305A00
	8 m	ED	ZA - GZ Tuchel 5-pol.	Standard	7T4SK083510305A00
	4 m	ED	ZA - GZ Tuchel 5-pol.	High Flex Leder	7T4SH043510305A00
	8 m	ED	ZA - GZ Tuchel 5-pol.	High Flex Leder	7T4SH083510305A00
ABITIG® 200F	4 m	ED	ZA - GZ Tuchel 5-pol.	Standard	7T4FK043510305A00
	8 m	ED	ZA - GZ Tuchel 5-pol.	Standard	7T4FK083510305A00
	4 m	ED	ZA - GZ Tuchel 5-pol.	High Flex Leder	7T4FH043510305A00
	8 m	ED	ZA - GZ Tuchel 5-pol.	High Flex Leder	7T4FH083510305A00
ABITIG® 150	4 m	ED	ZA - GZ Tuchel 5-pol.	Standard	7T6SK043510305A00
	8 m	ED	ZA - GZ Tuchel 5-pol.	Standard	7T6SK083510305A00
	4 m	ED	ZA - GZ Tuchel 5-pol.	High Flex Leder	7T6SH043510305A00
	8 m	ED	ZA - GZ Tuchel 5-pol.	High Flex Leder	7T6SH083510305A00
ABITIG® 150 Little	4 m	ED	ZA - GZ Tuchel 5-pol.	High Flex Leder	7L6SH043510305A00
	8 m	ED	ZA - GZ Tuchel 5-pol.	High Flex Leder	7L6SH083510305A00
ABITIG® 150F	4 m	ED	ZA - GZ Tuchel 5-pol.	Standard	7T6FK043510305A00
	8 m	ED	ZA - GZ Tuchel 5-pol.	Standard	7T6FK083510305A00
	4 m	ED	ZA - GZ Tuchel 5-pol.	High Flex Leder	7T6FH043510305A00
	8 m	ED	ZA - GZ Tuchel 5-pol.	High Flex Leder	7T6FH083510305A00
ABITIG® 150F Little	4 m	ED	ZA - GZ Tuchel 5-pol.	High Flex Leder	7L6FH043510305A00
	8 m	ED	ZA - GZ Tuchel 5-pol.	High Flex Leder	7L6FH083510305A00

ABITIG® GRIP / ABITIG® GRIP Little-Brennerpreisliste

passend für WIG-Stromquellen des Fabrikates „röwac“



Brennertyp	Länge	Schalterfunktion	maschinenseitiger Anschluss	Schlauchpaketausführung	Bestellnummer
ABITIG®	4 m	ED	ZA - WZ-0 Tuchel 5-pol.	Standard	7S4SK043510305A12
	8 m	ED	ZA - WZ-0 Tuchel 5-pol.	Standard	7S4SK083510305A12
	4 m	ED	ZA - WZ-0 Tuchel 5-pol.	High Flex Leder	7S4SH043510305A12
	8 m	ED	ZA - WZ-0 Tuchel 5-pol.	High Flex Leder	7S4SH083510305A12
ABITIG® 18F	4 m	ED	ZA - WZ-0 Tuchel 5-pol.	Standard	7S4FK043510305A12
	8 m	ED	ZA - WZ-0 Tuchel 5-pol.	Standard	7S4FK083510305A12
	4 m	ED	ZA - WZ-0 Tuchel 5-pol.	High Flex Leder	7S4FH043510305A12
	8 m	ED	ZA - WZ-0 Tuchel 5-pol.	High Flex Leder	7S4FH083510305A12
ABITIG® 20	4 m	ED	ZA - WZ-0 Tuchel 5-pol.	Standard	7S5SK043510305A12
	8 m	ED	ZA - WZ-0 Tuchel 5-pol.	Standard	7S5SK083510305A12
	4 m	ED	ZA - WZ-0 Tuchel 5-pol.	High Flex Leder	7S5SH043510305A12
	8 m	ED	ZA - WZ-0 Tuchel 5-pol.	High Flex Leder	7S5SH083510305A12
ABITIG® 20 Little	4 m	ED	ZA - WZ-0 Tuchel 5-pol.	High Flex Leder	7L5SH043510305A12
	8 m	ED	ZA - WZ-0 Tuchel 5-pol.	High Flex Leder	7L5SH083510305A12
ABITIG® 20F	4 m	ED	ZA - WZ-0 Tuchel 5-pol.	Standard	7S5FK043510305A12
	8 m	ED	ZA - WZ-0 Tuchel 5-pol.	Standard	7S5FK083510305A12
	4 m	ED	ZA - WZ-0 Tuchel 5-pol.	High Flex Leder	7S5FH043510305A12
	8 m	ED	ZA - WZ-0 Tuchel 5-pol.	High Flex Leder	7S5FH083510305A12
ABITIG® 20F Little	4 m	ED	ZA - WZ-0 Tuchel 5-pol.	High Flex Leder	7L5FH043510305A12
	8 m	ED	ZA - WZ-0 Tuchel 5-pol.	High Flex Leder	7L5FH083510305A12

Technische Änderungen vorbehalten • Verkaufspreise = unverbindliche Preisempfehlung - Angebot freibleibend • © Copyright

ABITIG® GRIP / ABITIG® GRIP Little-Brennerpreisliste

passend für WIG-Stromquellen des Fabrikates „röwac“

Brennertyp	Länge	Schalterfunktion	maschinenseitiger Anschluss	Schlauchpaketausführung	Bestellnummer
ABITIG® 12-1	4 m	ED	ZA - WZ-0 Tuchel 5-pol.	Standard	7S6SK043510305A12
	8 m	ED	ZA - WZ-0 Tuchel 5-pol.	Standard	7S6SK083510305A12
	4 m	ED	ZA - WZ-0 Tuchel 5-pol.	High Flex Leder	7S6SH043510305A12
	8 m	ED	ZA - WZ-0 Tuchel 5-pol.	High Flex Leder	7S6SH083510305A12
ABITIG® 18SC	4 m	ED	ZA - WZ-0 Tuchel 5-pol.	Standard	7S7SK043510305A12
	8 m	ED	ZA - WZ-0 Tuchel 5-pol.	Standard	7S7SK083510305A12
	4 m	ED	ZA - WZ-0 Tuchel 5-pol.	High Flex Leder	7S7SH043510305A12
	8 m	ED	ZA - WZ-0 Tuchel 5-pol.	High Flex Leder	7S7SH083510305A12
ABITIG® 24W	4 m	ED	ZA - WZ-0 Tuchel 5-pol.	Standard	7S9SK043510305A12
	8 m	ED	ZA - WZ-0 Tuchel 5-pol.	Standard	7S9SK083510305A12
	4 m	ED	ZA - WZ-0 Tuchel 5-pol.	High Flex Leder	7S9SH043510305A12
	8 m	ED	ZA - WZ-0 Tuchel 5-pol.	High Flex Leder	7S9SH083510305A12
ABITIG® 24W Little	4 m	ED	ZA - WZ-0 Tuchel 5-pol.	High Flex Leder	7L9SH043510305A12
	8 m	ED	ZA - WZ-0 Tuchel 5-pol.	High Flex Leder	7L9SH083510305A12
ABITIG® 450W	4 m	ED	ZA - WZ-0 Tuchel 5-pol.	Standard	7T5SK043510305A12
	8 m	ED	ZA - WZ-0 Tuchel 5-pol.	Standard	7T5SK083510305A12
	4 m	ED	ZA - WZ-0 Tuchel 5-pol.	High Flex Leder	7T5SH043510305A12
	8 m	ED	ZA - WZ-0 Tuchel 5-pol.	High Flex Leder	7T5SH083510305A12
ABITIG® 260W	4 m	ED	ZA - WZ-0 Tuchel 5-pol.	Standard	7T7SK043510305A12
	8 m	ED	ZA - WZ-0 Tuchel 5-pol.	Standard	7T7SK083510305A12
	4 m	ED	ZA - WZ-0 Tuchel 5-pol.	High Flex Leder	7T7SH043510305A12
	8 m	ED	ZA - WZ-0 Tuchel 5-pol.	High Flex Leder	7T7SH083510305A12
ABITIG® 260W Little	4 m	ED	ZA - WZ-0 Tuchel 5-pol.	High Flex Leder	7L7SH043510305A12
	8 m	ED	ZA - WZ-0 Tuchel 5-pol.	High Flex Leder	7L7SH083510305A12
ABITIG® 450W SC	4 m	ED	ZA - WZ-0 Tuchel 5-pol.	Standard	
	8 m	ED	ZA - WZ-0 Tuchel 5-pol.	Standard	
	4 m	ED	ZA - WZ-0 Tuchel 5-pol.	High Flex Leder	7T8SH043510305A12
	8 m	ED	ZA - WZ-0 Tuchel 5-pol.	High Flex Leder	7T8SH083510305A12

ABITIG® GRIP / ABITIG® GRIP Little-Brennerpreisliste

passend für WIG-Stromquellen des Fabrikates „röwac/röwig“

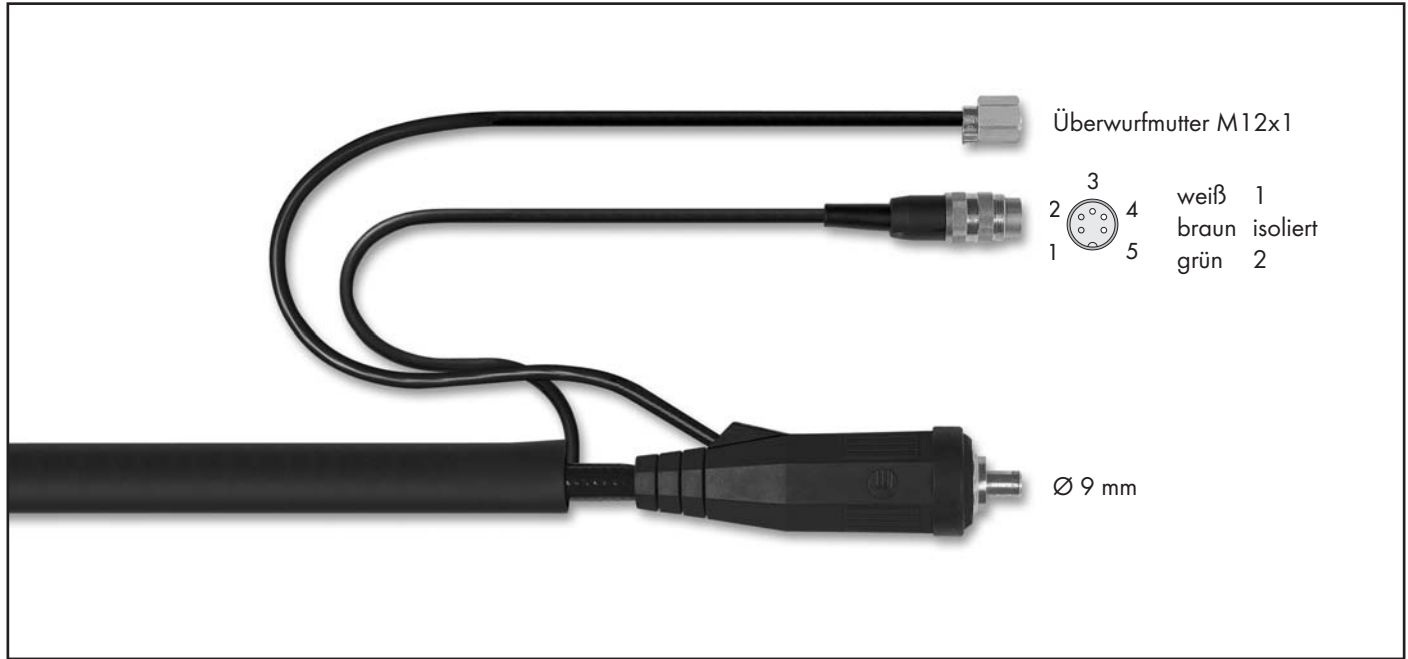

Brennertyp	Länge	Schalterfunktion	maschinenseitiger Anschluss	Schlauchpaketausführung	Bestellnummer
ABITIG® 9	4 m	ED	BSB 10-25 Kabelstecker 5-pol.	Standard	7S1SK043512240A09
	8 m	ED	BSB 10-25 Kabelstecker 5-pol.	Standard	7S1SK083512240A09
	4 m	ED	BSB 10-25 Kabelstecker 5-pol.	High Flex Leder	7S1SH043512240A09
	8 m	ED	BSB 10-25 Kabelstecker 5-pol.	High Flex Leder	7S1SH083512240A09
ABITIG® 9 Little	4 m	ED	BSB 10-25 Kabelstecker 5-pol.	High Flex Leder	7L1SH043512240A09
	8 m	ED	BSB 10-25 Kabelstecker 5-pol.	High Flex Leder	7L1SH083512240A09
ABITIG® 9F	4 m	ED	BSB 10-25 Kabelstecker 5-pol.	Standard	7S1FK043512240A09
	8 m	ED	BSB 10-25 Kabelstecker 5-pol.	Standard	7S1FK083512240A09
	4 m	ED	BSB 10-25 Kabelstecker 5-pol.	High Flex Leder	7S1FH043512240A09
	8 m	ED	BSB 10-25 Kabelstecker 5-pol.	High Flex Leder	7S1FH083512240A09
ABITIG® 9F Little	4 m	ED	BSB 10-25 Kabelstecker 5-pol.	High Flex Leder	7L1FH043512240A09
	8 m	ED	BSB 10-25 Kabelstecker 5-pol.	High Flex Leder	7L1FH083512240A09
ABITIG® 17	4 m	ED	BSB 10-25 Kabelstecker 5-pol.	Standard	7S2SK043512240A09
	8 m	ED	BSB 10-25 Kabelstecker 5-pol.	Standard	7S2SK083512240A09
	4 m	ED	BSB 10-25 Kabelstecker 5-pol.	High Flex Leder	7S2SH043512240A09
	8 m	ED	BSB 10-25 Kabelstecker 5-pol.	High Flex Leder	7S2SH083512240A09
ABITIG® 17 Little	4 m	ED	BSB 10-25 Kabelstecker 5-pol.	High Flex Leder	7L2SH043512240A09
	8 m	ED	BSB 10-25 Kabelstecker 5-pol.	High Flex Leder	7L2SH083512240A09
ABITIG® 17F	4 m	ED	BSB 10-25 Kabelstecker 5-pol.	Standard	7S2FK043512240A09
	8 m	ED	BSB 10-25 Kabelstecker 5-pol.	Standard	7S2FK083512240A09
	4 m	ED	BSB 10-25 Kabelstecker 5-pol.	High Flex Leder	7S2FH043512240A09
	8 m	ED	BSB 10-25 Kabelstecker 5-pol.	High Flex Leder	7S2FH083512240A09
ABITIG® 17F Little	4 m	ED	BSB 10-25 Kabelstecker 5-pol.	High Flex Leder	7L2FH043512240A09
	8 m	ED	BSB 10-25 Kabelstecker 5-pol.	High Flex Leder	7L2FH083512240A09

Technische Änderungen vorbehalten • Verkaufspreise = unverbindliche Preisempfehlung - Angebot freibleibend • © Copyright

ABITIG® GRIP / ABITIG® GRIP Little-Brennerpreisliste

passend für WIG-Stromquellen des Fabrikates „röwac/röwig“

Brennertyp	Länge	Schalterfunktion	maschinenseitiger Anschluss	Schlauchpaketausführung	Bestellnummer
ABITIG® 26	4 m	ED	BSB 10-25 Kabelstecker 5-pol.	Standard	7S3SK043512240A09
	8 m	ED	BSB 10-25 Kabelstecker 5-pol.	Standard	7S3SK083512240A09
	4 m	ED	BSB 10-25 Kabelstecker 5-pol.	High Flex Leder	7S3SH043512240A09
	8 m	ED	BSB 10-25 Kabelstecker 5-pol.	High Flex Leder	7S3SH083512240A09
ABITIG® 26F	4 m	ED	BSB 10-25 Kabelstecker 5-pol.	Standard	7S3FK043512240A09
	8 m	ED	BSB 10-25 Kabelstecker 5-pol.	Standard	7S3FK083512240A09
	4 m	ED	BSB 10-25 Kabelstecker 5-pol.	High Flex Leder	7S3FH043512240A09
	8 m	ED	BSB 10-25 Kabelstecker 5-pol.	High Flex Leder	7S3FH083512240A09
ABITIG® 24G	4 m	ED	BSB 10-25 Kabelstecker 5-pol.	Standard	7S8SK043512240A09
	8 m	ED	BSB 10-25 Kabelstecker 5-pol.	Standard	7S8SK083512240A09
	4 m	ED	BSB 10-25 Kabelstecker 5-pol.	High Flex Leder	7S8SH043512240A09
	8 m	ED	BSB 10-25 Kabelstecker 5-pol.	High Flex Leder	7S8SH083512240A09
ABITIG® 24G Little	4 m	ED	BSB 10-25 Kabelstecker 5-pol.	High Flex Leder	7L8SH043512240A09
	8 m	ED	BSB 10-25 Kabelstecker 5-pol.	High Flex Leder	7L8SH083512240A09
ABITIG® 200	4 m	ED	BSB 10-25 Kabelstecker 5-pol.	Standard	7T4SK043512240A09
	8 m	ED	BSB 10-25 Kabelstecker 5-pol.	Standard	7T4SK083512240A09
	4 m	ED	BSB 10-25 Kabelstecker 5-pol.	High Flex Leder	7T4SH043512240A09
	8 m	ED	BSB 10-25 Kabelstecker 5-pol.	High Flex Leder	7T4SH083512240A09
ABITIG® 200F	4 m	ED	BSB 10-25 Kabelstecker 5-pol.	Standard	7T4FK043512240A09
	8 m	ED	BSB 10-25 Kabelstecker 5-pol.	Standard	7T4FK083512240A09
	4 m	ED	BSB 10-25 Kabelstecker 5-pol.	High Flex Leder	7T4FH043512240A09
	8 m	ED	BSB 10-25 Kabelstecker 5-pol.	High Flex Leder	7T4FH083512240A09
ABITIG® 150	4 m	ED	BSB 10-25 Kabelstecker 5-pol.	Standard	7T6SK043512240A09
	8 m	ED	BSB 10-25 Kabelstecker 5-pol.	Standard	7T6SK083512240A09
	4 m	ED	BSB 10-25 Kabelstecker 5-pol.	High Flex Leder	7T6SH043512240A09
	8 m	ED	BSB 10-25 Kabelstecker 5-pol.	High Flex Leder	7T6SH083512240A09
ABITIG® 150 Little	4 m	ED	BSB 10-25 Kabelstecker 5-pol.	High Flex Leder	7L6SH043512240A09
	8 m	ED	BSB 10-25 Kabelstecker 5-pol.	High Flex Leder	7L6SH083512240A09
ABITIG® 150F	4 m	ED	BSB 10-25 Kabelstecker 5-pol.	Standard	7T6FK043512240A09
	8 m	ED	BSB 10-25 Kabelstecker 5-pol.	Standard	7T6FK083512240A09
	4 m	ED	BSB 10-25 Kabelstecker 5-pol.	High Flex Leder	7T6FH043512240A09
	8 m	ED	BSB 10-25 Kabelstecker 5-pol.	High Flex Leder	7T6FH083512240A09
ABITIG® 150F Little	4 m	ED	BSB 10-25 Kabelstecker 5-pol.	High Flex Leder	7L6FH043512240A09
	8 m	ED	BSB 10-25 Kabelstecker 5-pol.	High Flex Leder	7L6FH083512240A09

ABITIG® GRIP / ABITIG® GRIP Little-Brennerpreisliste

passend für WIG-Stromquellen des Fabrikates „röwac/röwig“

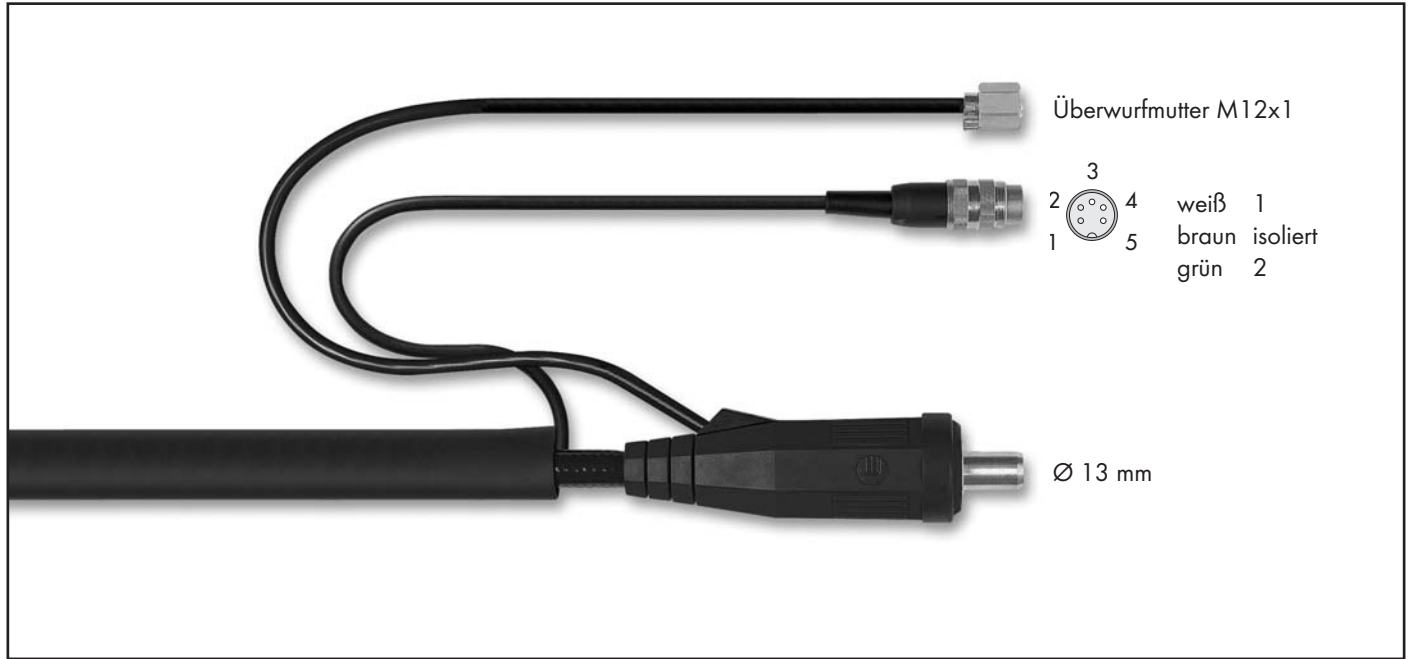

Brennertyp	Länge	Schalterfunktion	maschinenseitiger Anschluss	Schlauchpaketausführung	Bestellnummer
ABITIG® 9	4 m	ED	BSB 35-50 Kabelstecker 5-pol.	Standard	7S1SK043510040A09
	8 m	ED	BSB 35-50 Kabelstecker 5-pol.	Standard	7S1SK083510040A09
	4 m	ED	BSB 35-50 Kabelstecker 5-pol.	High Flex Leder	7S1SH043510040A09
	8 m	ED	BSB 35-50 Kabelstecker 5-pol.	High Flex Leder	7S1SH083510040A09
ABITIG® 9 Little	4 m	ED	BSB 35-50 Kabelstecker 5-pol.	High Flex Leder	7L1SH043510040A09
	8 m	ED	BSB 35-50 Kabelstecker 5-pol.	High Flex Leder	7L1SH083510040A09
ABITIG® 9F	4 m	ED	BSB 35-50 Kabelstecker 5-pol.	Standard	7S1FK043510040A09
	8 m	ED	BSB 35-50 Kabelstecker 5-pol.	Standard	7S1FK083510040A09
	4 m	ED	BSB 35-50 Kabelstecker 5-pol.	High Flex Leder	7S1FH043510040A09
	8 m	ED	BSB 35-50 Kabelstecker 5-pol.	High Flex Leder	7S1FH083510040A09
ABITIG® 9F Little	4 m	ED	BSB 35-50 Kabelstecker 5-pol.	High Flex Leder	7L1FH043510040A09
	8 m	ED	BSB 35-50 Kabelstecker 5-pol.	High Flex Leder	7L1FH083510040A09
ABITIG® 17	4 m	ED	BSB 35-50 Kabelstecker 5-pol.	Standard	7S2SK043510040A09
	8 m	ED	BSB 35-50 Kabelstecker 5-pol.	Standard	7S2SK083510040A09
	4 m	ED	BSB 35-50 Kabelstecker 5-pol.	High Flex Leder	7S2SH043510040A09
	8 m	ED	BSB 35-50 Kabelstecker 5-pol.	High Flex Leder	7S2SH083510040A09
ABITIG® 17 Little	4 m	ED	BSB 35-50 Kabelstecker 5-pol.	High Flex Leder	7L2SH043510040A09
	8 m	ED	BSB 35-50 Kabelstecker 5-pol.	High Flex Leder	7L2SH083510040A09
ABITIG® 17F	4 m	ED	BSB 35-50 Kabelstecker 5-pol.	Standard	7S2FK043510040A09
	8 m	ED	BSB 35-50 Kabelstecker 5-pol.	Standard	7S2FK083510040A09
	4 m	ED	BSB 35-50 Kabelstecker 5-pol.	High Flex Leder	7S2FH043510040A09
	8 m	ED	BSB 35-50 Kabelstecker 5-pol.	High Flex Leder	7S2FH083510040A09
ABITIG® 17F Little	4 m	ED	BSB 35-50 Kabelstecker 5-pol.	High Flex Leder	7L2FH043510040A09
	8 m	ED	BSB 35-50 Kabelstecker 5-pol.	High Flex Leder	7L2FH083510040A09

Technische Änderungen vorbehalten • Verkaufspreise = unverbindliche Preisempfehlung - Angebot freibleibend • © Copyright

ABITIG® GRIP / ABITIG® GRIP Little-Brennerpreisliste

passend für WIG-Stromquellen des Fabrikates „röwac/röwig“

Brennertyp	Länge	Schalterfunktion	maschinenseitiger Anschluss	Schlauchpaketausführung	Bestellnummer
ABITIG® 26	4 m	ED	BSB 35-50 Kabelstecker 5-pol.	Standard	7S3SK043510040A09
	8 m	ED	BSB 35-50 Kabelstecker 5-pol.	Standard	7S3SK083510040A09
	4 m	ED	BSB 35-50 Kabelstecker 5-pol.	High Flex Leder	7S3SH043510040A09
	8 m	ED	BSB 35-50 Kabelstecker 5-pol.	High Flex Leder	7S3SH083510040A09
ABITIG® 26F	4 m	ED	BSB 35-50 Kabelstecker 5-pol.	Standard	7S3FK043510040A09
	8 m	ED	BSB 35-50 Kabelstecker 5-pol.	Standard	7S3FK083510040A09
	4 m	ED	BSB 35-50 Kabelstecker 5-pol.	High Flex Leder	7S3FH043510040A09
	8 m	ED	BSB 35-50 Kabelstecker 5-pol.	High Flex Leder	7S3FH083510040A09
ABITIG® 24G	4 m	ED	BSB 35-50 Kabelstecker 5-pol.	Standard	7S8SK043510040A09
	8 m	ED	BSB 35-50 Kabelstecker 5-pol.	Standard	7S8SK083510040A09
	4 m	ED	BSB 35-50 Kabelstecker 5-pol.	High Flex Leder	7S8SH043510040A09
	8 m	ED	BSB 35-50 Kabelstecker 5-pol.	High Flex Leder	7S8SH083510040A09
ABITIG® 24G Little	4 m	ED	BSB 35-50 Kabelstecker 5-pol.	High Flex Leder	7L8SH043510040A09
	8 m	ED	BSB 35-50 Kabelstecker 5-pol.	High Flex Leder	7L8SH083510040A09
ABITIG® 200	4 m	ED	BSB 35-50 Kabelstecker 5-pol.	Standard	7T4SK043510040A09
	8 m	ED	BSB 35-50 Kabelstecker 5-pol.	Standard	7T4SK083510040A09
	4 m	ED	BSB 35-50 Kabelstecker 5-pol.	High Flex Leder	7T4SH043510040A09
	8 m	ED	BSB 35-50 Kabelstecker 5-pol.	High Flex Leder	7T4SH083510040A09
ABITIG® 200F	4 m	ED	BSB 35-50 Kabelstecker 5-pol.	Standard	7T4FK043510040A09
	8 m	ED	BSB 35-50 Kabelstecker 5-pol.	Standard	7T4FK083510040A09
	4 m	ED	BSB 35-50 Kabelstecker 5-pol.	High Flex Leder	7T4FH043510040A09
	8 m	ED	BSB 35-50 Kabelstecker 5-pol.	High Flex Leder	7T4FH083510040A09
ABITIG® 150	4 m	ED	BSB 35-50 Kabelstecker 5-pol.	Standard	7T6SK043510040A09
	8 m	ED	BSB 35-50 Kabelstecker 5-pol.	Standard	7T6SK083510040A09
	4 m	ED	BSB 35-50 Kabelstecker 5-pol.	High Flex Leder	7T6SH043510040A09
	8 m	ED	BSB 35-50 Kabelstecker 5-pol.	High Flex Leder	7T6SH083510040A09
ABITIG® 150 Little	4 m	ED	BSB 35-50 Kabelstecker 5-pol.	High Flex Leder	7L6SH043510040A09
	8 m	ED	BSB 35-50 Kabelstecker 5-pol.	High Flex Leder	7L6SH083510040A09
ABITIG® 150F	4 m	ED	BSB 35-50 Kabelstecker 5-pol.	Standard	7T6FK043510040A09
	8 m	ED	BSB 35-50 Kabelstecker 5-pol.	Standard	7T6FK083510040A09
	4 m	ED	BSB 35-50 Kabelstecker 5-pol.	High Flex Leder	7T6FH043510040A09
	8 m	ED	BSB 35-50 Kabelstecker 5-pol.	High Flex Leder	7T6FH083510040A09
ABITIG® 150F Little	4 m	ED	BSB 35-50 Kabelstecker 5-pol.	High Flex Leder	7L6FH043510040A09
	8 m	ED	BSB 35-50 Kabelstecker 5-pol.	High Flex Leder	7L6FH083510040A09

ABITIG® GRIP / ABITIG® GRIP Little-Brennerpreisliste

passend für WIG-Stromquellen des Fabrikates „röwac/röwig“

Nur Röwig 180 DC und 180 AC/DC



Brennertyp	Länge	Schalterfunktion	maschinenseitiger Anschluss	Schlauchpaketausführung	Bestellnummer
ABITIG® 9	4 m	ED	ZA 9-pol.	Standard	7S1SK043510797D00
	8 m	ED	ZA 9-pol.	Standard	7S1SK083510797D00
	4 m	ED	ZA 9-pol.	High Flex Leder	7S1SH043510797D00
	8 m	ED	ZA 9-pol.	High Flex Leder	7S1SH083510797D00
ABITIG® 9 Little	4 m	ED	ZA 9-pol.	High Flex Leder	7L1SH043510797D00
	8 m	ED	ZA 9-pol.	High Flex Leder	7L1SH083510797D00
ABITIG® 9F	4 m	ED	ZA 9-pol.	Standard	7S1FK043510797D00
	8 m	ED	ZA 9-pol.	Standard	7S1FK083510797D00
	4 m	ED	ZA 9-pol.	High Flex Leder	7S1FH043510797D00
	8 m	ED	ZA 9-pol.	High Flex Leder	7S1FH083510797D00
ABITIG® 9F Little	4 m	ED	ZA 9-pol.	High Flex Leder	7L1FH043510797D00
	8 m	ED	ZA 9-pol.	High Flex Leder	7L1FH083510797D00
ABITIG® 17	4 m	ED	ZA 9-pol.	Standard	7S2SK043510797D00
	8 m	ED	ZA 9-pol.	Standard	7S2SK083510797D00
	4 m	ED	ZA 9-pol.	High Flex Leder	7S2SH043510797D00
	8 m	ED	ZA 9-pol.	High Flex Leder	7S2SH083510797D00
ABITIG® 17 Little	4 m	ED	ZA 9-pol.	High Flex Leder	7L2SH043510797D00
	8 m	ED	ZA 9-pol.	High Flex Leder	7L2SH083510797D00
ABITIG® 17F	4 m	ED	ZA 9-pol.	Standard	7S2FK043510797D00
	8 m	ED	ZA 9-pol.	Standard	7S2FK083510797D00
	4 m	ED	ZA 9-pol.	High Flex Leder	7S2FH043510797D00
	8 m	ED	ZA 9-pol.	High Flex Leder	7S2FH083510797D00
ABITIG® 17F Little	4 m	ED	ZA 9-pol.	High Flex Leder	7L2FH043510797D00
	8 m	ED	ZA 9-pol.	High Flex Leder	7L2FH083510797D00

Technische Änderungen vorbehalten • Verkaufspreise = unverbindliche Preisempfehlung - Angebot freibleibend • © Copyright

ABITIG® GRIP / ABITIG® GRIP Little-Brennerpreisliste

passend für WIG-Stromquellen des Fabrikates „röwac/röwig“

Brennertyp	Länge	Schalterfunktion	maschinenseitiger Anschluss	Schlauchpaketausführung	Bestellnummer
ABITIG® 26	4 m	ED	ZA 9-pol.	Standard	7S3SK043510797D00
	8 m	ED	ZA 9-pol.	Standard	7S3SK083510797D00
	4 m	ED	ZA 9-pol.	High Flex Leder	7S3SH043510797D00
	8 m	ED	ZA 9-pol.	High Flex Leder	7S3SH083510797D00
ABITIG® 26F	4 m	ED	ZA 9-pol.	Standard	7S3FK043510797D00
	8 m	ED	ZA 9-pol.	Standard	7S3FK083510797D00
	4 m	ED	ZA 9-pol.	High Flex Leder	7S3FH043510797D00
	8 m	ED	ZA 9-pol.	High Flex Leder	7S3FH083510797D00
ABITIG® 24G	4 m	ED	ZA 9-pol.	Standard	7S8SK043510797D00
	8 m	ED	ZA 9-pol.	Standard	7S8SK083510797D00
	4 m	ED	ZA 9-pol.	High Flex Leder	7S8SH043510797D00
	8 m	ED	ZA 9-pol.	High Flex Leder	7S8SH083510797D00
ABITIG® 24G Little	4 m	ED	ZA 9-pol.	High Flex Leder	7L8SH043510797D00
	8 m	ED	ZA 9-pol.	High Flex Leder	7L8SH083510797D00
ABITIG® 200	4 m	ED	ZA 9-pol.	Standard	7T4SK043510797D00
	8 m	ED	ZA 9-pol.	Standard	7T4SK083510797D00
	4 m	ED	ZA 9-pol.	High Flex Leder	7T4SH043510797D00
	8 m	ED	ZA 9-pol.	High Flex Leder	7T4SH083510797D00
ABITIG® 200F	4 m	ED	ZA 9-pol.	Standard	7T4FK043510797D00
	8 m	ED	ZA 9-pol.	Standard	7T4FK083510797D00
	4 m	ED	ZA 9-pol.	High Flex Leder	7T4FH043510797D00
	8 m	ED	ZA 9-pol.	High Flex Leder	7T4FH083510797D00
ABITIG® 150	4 m	ED	ZA 9-pol.	Standard	7T6SK043510797D00
	8 m	ED	ZA 9-pol.	Standard	7T6SK083510797D00
	4 m	ED	ZA 9-pol.	High Flex Leder	7T6SH043510797D00
	8 m	ED	ZA 9-pol.	High Flex Leder	7T6SH083510797D00
ABITIG® 150 Little	4 m	ED	ZA 9-pol.	High Flex Leder	7L6SH043510797D00
	8 m	ED	ZA 9-pol.	High Flex Leder	7L6SH083510797D00
ABITIG® 150F	4 m	ED	ZA 9-pol.	Standard	7T6FK043510797D00
	8 m	ED	ZA 9-pol.	Standard	7T6FK083510797D00
	4 m	ED	ZA 9-pol.	High Flex Leder	7T6FH043510797D00
	8 m	ED	ZA 9-pol.	High Flex Leder	7T6FH083510797D00
ABITIG® 150F Little	4 m	ED	ZA 9-pol.	High Flex Leder	7L6FH043510797D00
	8 m	ED	ZA 9-pol.	High Flex Leder	7L6FH083510797D00

ABITIG® GRIP / ABITIG® GRIP Little-Brennerpreisliste

passend für WIG-Stromquellen des Fabrikates „röwac/röwig“



Brennertyp	Länge	Schalterfunktion	maschinenseitiger Anschluss	Schlauchpaketausführung	Bestellnummer
ABITIG® 9	4 m	ED	ZA 9-pol.	Standard	7S1SK043510797C00
	8 m	ED	ZA 9-pol.	Standard	7S1SK083510797C00
	4 m	ED	ZA 9-pol.	High Flex Leder	7S1SH043510797C00
	8 m	ED	ZA 9-pol.	High Flex Leder	7S1SH083510797C00
ABITIG® 9 Little	4 m	ED	ZA 9-pol.	High Flex Leder	7L1SH043510797C00
	8 m	ED	ZA 9-pol.	High Flex Leder	7L1SH083510797C00
ABITIG® 9F	4 m	ED	ZA 9-pol.	Standard	7S1FK043510797C00
	8 m	ED	ZA 9-pol.	Standard	7S1FK083510797C00
	4 m	ED	ZA 9-pol.	High Flex Leder	7S1FH043510797C00
	8 m	ED	ZA 9-pol.	High Flex Leder	7S1FH083510797C00
ABITIG® 9F Little	4 m	ED	ZA 9-pol.	High Flex Leder	7L1FH043510797C00
	8 m	ED	ZA 9-pol.	High Flex Leder	7L1FH083510797C00
ABITIG® 17	4 m	ED	ZA 9-pol.	Standard	7S2SK043510797C00
	8 m	ED	ZA 9-pol.	Standard	7S2SK083510797C00
	4 m	ED	ZA 9-pol.	High Flex Leder	7S2SH043510797C00
	8 m	ED	ZA 9-pol.	High Flex Leder	7S2SH083510797C00
ABITIG® 17 Little	4 m	ED	ZA 9-pol.	High Flex Leder	7L2SH043510797C00
	8 m	ED	ZA 9-pol.	High Flex Leder	7L2SH083510797C00
ABITIG® 17F	4 m	ED	ZA 9-pol.	Standard	7S2FK043510797C00
	8 m	ED	ZA 9-pol.	Standard	7S2FK083510797C00
	4 m	ED	ZA 9-pol.	High Flex Leder	7S2FH043510797C00
	8 m	ED	ZA 9-pol.	High Flex Leder	7S2FH083510797C00
ABITIG® 17F Little	4 m	ED	ZA 9-pol.	High Flex Leder	7L2FH043510797C00
	8 m	ED	ZA 9-pol.	High Flex Leder	7L2FH083510797C00

Technische Änderungen vorbehalten • Verkaufspreise = unverbindliche Preisempfehlung - Angebot freibleibend • © Copyright

ABITIG® GRIP / ABITIG® GRIP Little-Brennerpreisliste

passend für WIG-Stromquellen des Fabrikates „röwac/röwig“

Brennertyp	Länge	Schalterfunktion	maschinenseitiger Anschluss	Schlauchpaketausführung	Bestellnummer
ABITIG® 26	4 m	ED	ZA 9-pol.	Standard	7S3SK043510797C00
	8 m	ED	ZA 9-pol.	Standard	7S3SK083510797C00
	4 m	ED	ZA 9-pol.	High Flex Leder	7S3SH043510797C00
	8 m	ED	ZA 9-pol.	High Flex Leder	7S3SH083510797C00
ABITIG® 26F	4 m	ED	ZA 9-pol.	Standard	7S3FK043510797C00
	8 m	ED	ZA 9-pol.	Standard	7S3FK083510797C00
	4 m	ED	ZA 9-pol.	High Flex Leder	7S3FH043510797C00
	8 m	ED	ZA 9-pol.	High Flex Leder	7S3FH083510797C00
ABITIG® 24G	4 m	ED	ZA 9-pol.	Standard	7S8SK043510797C00
	8 m	ED	ZA 9-pol.	Standard	7S8SK083510797C00
	4 m	ED	ZA 9-pol.	High Flex Leder	7S8SH043510797C00
	8 m	ED	ZA 9-pol.	High Flex Leder	7S8SH083510797C00
ABITIG® 24G Little	4 m	ED	ZA 9-pol.	High Flex Leder	7L8SH043510797C00
	8 m	ED	ZA 9-pol.	High Flex Leder	7L8SH083510797C00
ABITIG® 200	4 m	ED	ZA 9-pol.	Standard	7T4SK043510797C00
	8 m	ED	ZA 9-pol.	Standard	7T4SK083510797C00
	4 m	ED	ZA 9-pol.	High Flex Leder	7T4SH043510797C00
	8 m	ED	ZA 9-pol.	High Flex Leder	7T4SH083510797C00
ABITIG® 200F	4 m	ED	ZA 9-pol.	Standard	7T4FK043510797C00
	8 m	ED	ZA 9-pol.	Standard	7T4FK083510797C00
	4 m	ED	ZA 9-pol.	High Flex Leder	7T4FH043510797C00
	8 m	ED	ZA 9-pol.	High Flex Leder	7T4FH083510797C00
ABITIG® 150	4 m	ED	ZA 9-pol.	Standard	7T6SK043510797C00
	8 m	ED	ZA 9-pol.	Standard	7T6SK083510797C00
	4 m	ED	ZA 9-pol.	High Flex Leder	7T6SH043510797C00
	8 m	ED	ZA 9-pol.	High Flex Leder	7T6SH083510797C00
ABITIG® 150 Little	4 m	ED	ZA 9-pol.	High Flex Leder	7L6SH043510797C00
	8 m	ED	ZA 9-pol.	High Flex Leder	7L6SH083510797C00
ABITIG® 150F	4 m	ED	ZA 9-pol.	Standard	7T6FK043510797C00
	8 m	ED	ZA 9-pol.	Standard	7T6FK083510797C00
	4 m	ED	ZA 9-pol.	High Flex Leder	7T6FH043510797C00
	8 m	ED	ZA 9-pol.	High Flex Leder	7T6FH083510797C00
ABITIG® 150F Little	4 m	ED	ZA 9-pol.	High Flex Leder	7L6FH043510797C00
	8 m	ED	ZA 9-pol.	High Flex Leder	7L6FH083510797C00

ABITIG® GRIP / ABITIG® GRIP Little-Brennerpreisliste

passend für WIG-Stromquellen des Fabrikates „rs welding systems“

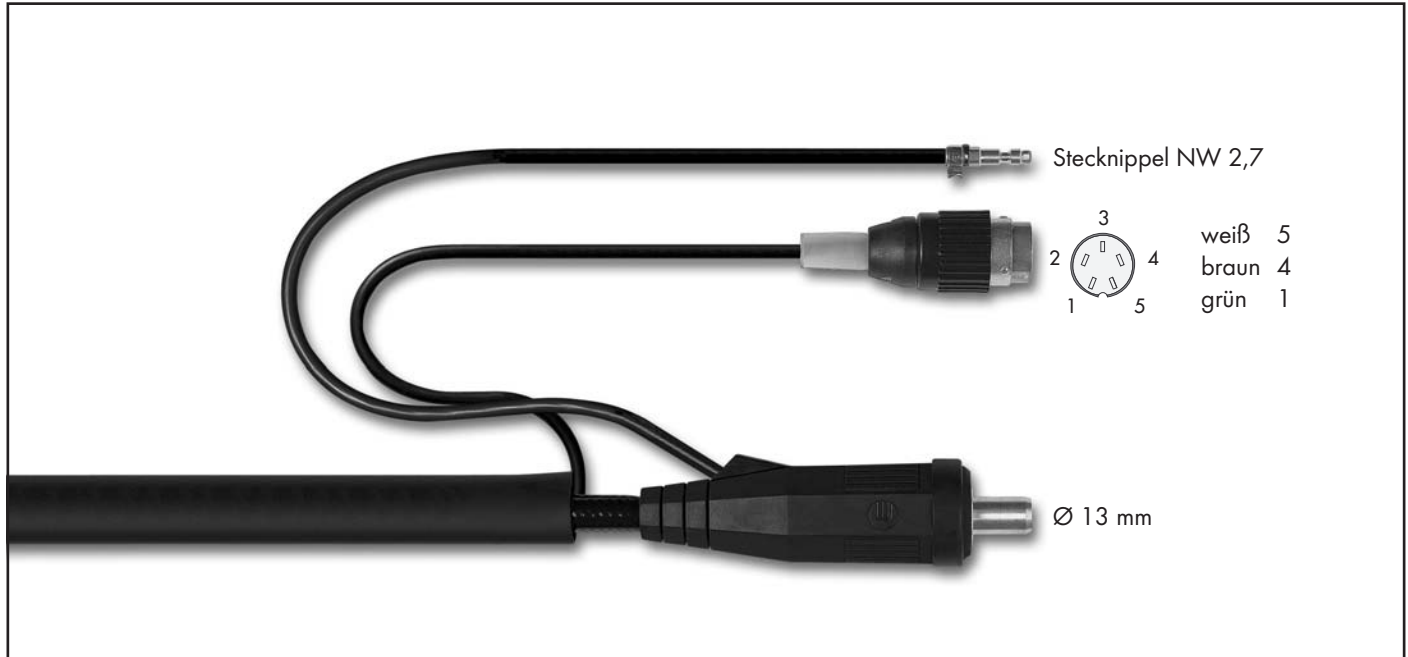

Brennertyp	Länge	Schalterfunktion	maschinenseitiger Anschluss	Schlauchpaketausführung	Bestellnummer
ABITIG® 9	4 m	DD	BSB 35-50 Tuchel 5-pol.	Standard	7S1SK043520050A04
	8 m	DD	BSB 35-50 Tuchel 5-pol.	Standard	7S1SK083520050A04
	4 m	DD	BSB 35-50 Tuchel 5-pol.	High Flex Leder	7S1SH043520050A04
	8 m	DD	BSB 35-50 Tuchel 5-pol.	High Flex Leder	7S1SH083520050A04
ABITIG® 9 Little	4 m	DD	BSB 35-50 Tuchel 5-pol.	High Flex Leder	7L1SH043520050A04
	8 m	DD	BSB 35-50 Tuchel 5-pol.	High Flex Leder	7L1SH083520050A04
ABITIG® 9F	4 m	DD	BSB 35-50 Tuchel 5-pol.	Standard	7S1FK043520050A04
	8 m	DD	BSB 35-50 Tuchel 5-pol.	Standard	7S1FK083520050A04
	4 m	DD	BSB 35-50 Tuchel 5-pol.	High Flex Leder	7S1FH043520050A04
	8 m	DD	BSB 35-50 Tuchel 5-pol.	High Flex Leder	7S1FH083520050A04
ABITIG® 9F Little	4 m	DD	BSB 35-50 Tuchel 5-pol.	High Flex Leder	7L1FH043520050A04
	8 m	DD	BSB 35-50 Tuchel 5-pol.	High Flex Leder	7L1FH083520050A04
ABITIG® 17	4 m	DD	BSB 35-50 Tuchel 5-pol.	Standard	7S2SK043520050A04
	8 m	DD	BSB 35-50 Tuchel 5-pol.	Standard	7S2SK083520050A04
	4 m	DD	BSB 35-50 Tuchel 5-pol.	High Flex Leder	7S2SH043520050A04
	8 m	DD	BSB 35-50 Tuchel 5-pol.	High Flex Leder	7S2SH083520050A04
ABITIG® 17 Little	4 m	DD	BSB 35-50 Tuchel 5-pol.	High Flex Leder	7L2SH043520050A04
	8 m	DD	BSB 35-50 Tuchel 5-pol.	High Flex Leder	7L2SH083520050A04
ABITIG® 17F	4 m	DD	BSB 35-50 Tuchel 5-pol.	Standard	7S2FK043520050A04
	8 m	DD	BSB 35-50 Tuchel 5-pol.	Standard	7S2FK083520050A04
	4 m	DD	BSB 35-50 Tuchel 5-pol.	High Flex Leder	7S2FH043520050A04
	8 m	DD	BSB 35-50 Tuchel 5-pol.	High Flex Leder	7S2FH083520050A04
ABITIG® 17F Little	4 m	DD	BSB 35-50 Tuchel 5-pol.	High Flex Leder	7L2FH043520050A04
	8 m	DD	BSB 35-50 Tuchel 5-pol.	High Flex Leder	7L2FH083520050A04

Technische Änderungen vorbehalten • Verkaufspreise = unverbindliche Preisempfehlung - Angebot freibleibend • © Copyright

ABITIG® GRIP / ABITIG® GRIP Little-Brennerpreisliste

passend für WIG-Stromquellen des Fabrikates „rs welding systems“

Brennertyp	Länge	Schalterfunktion	maschinenseitiger Anschluss	Schlauchpaketausführung	Bestellnummer
ABITIG® 26	4 m	DD	BSB 35-50 Tuchel 5-pol.	Standard	7S3SK043520050A04
	8 m	DD	BSB 35-50 Tuchel 5-pol.	Standard	7S3SK083520050A04
	4 m	DD	BSB 35-50 Tuchel 5-pol.	High Flex Leder	7S3SH043520050A04
	8 m	DD	BSB 35-50 Tuchel 5-pol.	High Flex Leder	7S3SH083520050A04
ABITIG® 26F	4 m	DD	BSB 35-50 Tuchel 5-pol.	Standard	7S3FK043520050A04
	8 m	DD	BSB 35-50 Tuchel 5-pol.	Standard	7S3FK083520050A04
	4 m	DD	BSB 35-50 Tuchel 5-pol.	High Flex Leder	7S3FH043520050A04
	8 m	DD	BSB 35-50 Tuchel 5-pol.	High Flex Leder	7S3FH083520050A04
ABITIG® 24G	4 m	DD	BSB 35-50 Tuchel 5-pol.	Standard	7S8SK043520050A04
	8 m	DD	BSB 35-50 Tuchel 5-pol.	Standard	7S8SK083520050A04
	4 m	DD	BSB 35-50 Tuchel 5-pol.	High Flex Leder	7S8SH043520050A04
	8 m	DD	BSB 35-50 Tuchel 5-pol.	High Flex Leder	7S8SH083520050A04
ABITIG® 24G Little	4 m	DD	BSB 35-50 Tuchel 5-pol.	High Flex Leder	7L8SH043520050A04
	8 m	DD	BSB 35-50 Tuchel 5-pol.	High Flex Leder	7L8SH083520050A04
ABITIG® 200	4 m	DD	BSB 35-50 Tuchel 5-pol.	Standard	7T4SK043520050A04
	8 m	DD	BSB 35-50 Tuchel 5-pol.	Standard	7T4SK083520050A04
	4 m	DD	BSB 35-50 Tuchel 5-pol.	High Flex Leder	7T4SH043520050A04
	8 m	DD	BSB 35-50 Tuchel 5-pol.	High Flex Leder	7T4SH083520050A04
ABITIG® 200F	4 m	DD	BSB 35-50 Tuchel 5-pol.	Standard	7T4FK043520050A04
	8 m	DD	BSB 35-50 Tuchel 5-pol.	Standard	7T4FK083520050A04
	4 m	DD	BSB 35-50 Tuchel 5-pol.	High Flex Leder	7T4FH043520050A04
	8 m	DD	BSB 35-50 Tuchel 5-pol.	High Flex Leder	7T4FH083520050A04
ABITIG® 150	4 m	DD	BSB 35-50 Tuchel 5-pol.	Standard	7T6SK043520050A04
	8 m	DD	BSB 35-50 Tuchel 5-pol.	Standard	7T6SK083520050A04
	4 m	DD	BSB 35-50 Tuchel 5-pol.	High Flex Leder	7T6SH043520050A04
	8 m	DD	BSB 35-50 Tuchel 5-pol.	High Flex Leder	7T6SH083520050A04
ABITIG® 150 Little	4 m	DD	BSB 35-50 Tuchel 5-pol.	High Flex Leder	7L6SH043520050A04
	8 m	DD	BSB 35-50 Tuchel 5-pol.	High Flex Leder	7L6SH083520050A04
ABITIG® 150F	4 m	DD	BSB 35-50 Tuchel 5-pol.	Standard	7T6FK043520050A04
	8 m	DD	BSB 35-50 Tuchel 5-pol.	Standard	7T6FK083520050A04
	4 m	DD	BSB 35-50 Tuchel 5-pol.	High Flex Leder	7T6FH043520050A04
	8 m	DD	BSB 35-50 Tuchel 5-pol.	High Flex Leder	7T6FH083520050A04
ABITIG® 150F Little	4 m	DD	BSB 35-50 Tuchel 5-pol.	High Flex Leder	7L6FH043520050A04
	8 m	DD	BSB 35-50 Tuchel 5-pol.	High Flex Leder	7L6FH083520050A04

ABITIG® GRIP / ABITIG® GRIP Little-Brennerpreisliste

passend für WIG-Stromquellen des Fabrikates „rs welding systems“

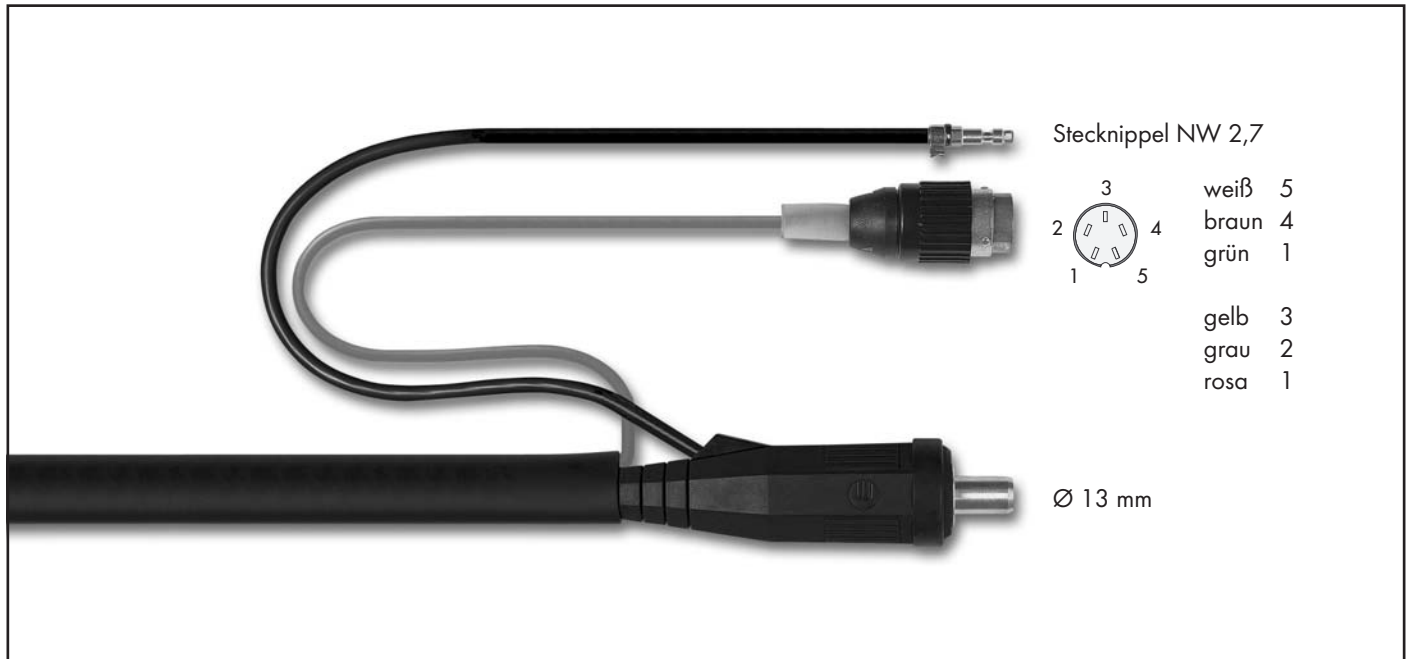

Brennertyp	Länge	Schalterfunktion	maschinenseitiger Anschluss	Schlauchpaketausführung	Bestellnummer
ABITIG® 9	4 m	DDP	BSB 35-50 Tuchel 5-pol.	Standard	7S1SK046540050B04
	8 m	DDP	BSB 35-50 Tuchel 5-pol.	Standard	7S1SK086540050B04
	4 m	DDP	BSB 35-50 Tuchel 5-pol.	High Flex Leder	7S1SH046540050B04
	8 m	DDP	BSB 35-50 Tuchel 5-pol.	High Flex Leder	7S1SH086540050B04
ABITIG® 9F	4 m	DDP	BSB 35-50 Tuchel 5-pol.	Standard	7S1FK046540050B04
	8 m	DDP	BSB 35-50 Tuchel 5-pol.	Standard	7S1FK086540050B04
	4 m	DDP	BSB 35-50 Tuchel 5-pol.	High Flex Leder	7S1FH046540050B04
	8 m	DDP	BSB 35-50 Tuchel 5-pol.	High Flex Leder	7S1FH086540050B04
ABITIG® 17	4 m	DDP	BSB 35-50 Tuchel 5-pol.	Standard	7S2SK046540050B04
	8 m	DDP	BSB 35-50 Tuchel 5-pol.	Standard	7S2SK086540050B04
	4 m	DDP	BSB 35-50 Tuchel 5-pol.	High Flex Leder	7S2SH046540050B04
	8 m	DDP	BSB 35-50 Tuchel 5-pol.	High Flex Leder	7S2SH086540050B04
ABITIG® 17F	4 m	DDP	BSB 35-50 Tuchel 5-pol.	Standard	7S2FK046540050B04
	8 m	DDP	BSB 35-50 Tuchel 5-pol.	Standard	7S2FK086540050B04
	4 m	DDP	BSB 35-50 Tuchel 5-pol.	High Flex Leder	7S2FH046540050B04
	8 m	DDP	BSB 35-50 Tuchel 5-pol.	High Flex Leder	7S2FH086540050B04

Technische Änderungen vorbehalten • Verkaufspreise = unverbindliche Preisempfehlung - Angebot freibleibend • © Copyright

ABITIG® GRIP / ABITIG® GRIP Little-Brennerpreisliste

passend für WIG-Stromquellen des Fabrikates „rs welding systems“

Brennertyp	Länge	Schalterfunktion	maschinenseitiger Anschluss	Schlauchpaketausführung	Bestellnummer
ABITIG® 26	4 m	DDP	BSB 35-50 Tuchel 5-pol.	Standard	7S3SK046540050B04
	8 m	DDP	BSB 35-50 Tuchel 5-pol.	Standard	7S3SK086540050B04
	4 m	DDP	BSB 35-50 Tuchel 5-pol.	High Flex Leder	7S3SH046540050B04
	8 m	DDP	BSB 35-50 Tuchel 5-pol.	High Flex Leder	7S3SH086540050B04
ABITIG® 26F	4 m	DDP	BSB 35-50 Tuchel 5-pol.	Standard	7S3FK046540050B04
	8 m	DDP	BSB 35-50 Tuchel 5-pol.	Standard	7S3FK086540050B04
	4 m	DDP	BSB 35-50 Tuchel 5-pol.	High Flex Leder	7S3FH046540050B04
	8 m	DDP	BSB 35-50 Tuchel 5-pol.	High Flex Leder	7S3FH086540050B04
ABITIG® 24G	4 m	DDP	BSB 35-50 Tuchel 5-pol.	Standard	7S8SK046540050B04
	8 m	DDP	BSB 35-50 Tuchel 5-pol.	Standard	7S8SK086540050B04
	4 m	DDP	BSB 35-50 Tuchel 5-pol.	High Flex Leder	7S8SH046540050B04
	8 m	DDP	BSB 35-50 Tuchel 5-pol.	High Flex Leder	7S8SH086540050B04
ABITIG® 200	4 m	DDP	BSB 35-50 Tuchel 5-pol.	Standard	7T4SK046540050B04
	8 m	DDP	BSB 35-50 Tuchel 5-pol.	Standard	7T4SK086540050B04
	4 m	DDP	BSB 35-50 Tuchel 5-pol.	High Flex Leder	7T4SH046540050B04
	8 m	DDP	BSB 35-50 Tuchel 5-pol.	High Flex Leder	7T4SH086540050B04
ABITIG® 200F	4 m	DDP	BSB 35-50 Tuchel 5-pol.	Standard	7T4FK046540050B04
	8 m	DDP	BSB 35-50 Tuchel 5-pol.	Standard	7T4FK086540050B04
	4 m	DDP	BSB 35-50 Tuchel 5-pol.	High Flex Leder	7T4FH046540050B04
	8 m	DDP	BSB 35-50 Tuchel 5-pol.	High Flex Leder	7T4FH086540050B04
ABITIG® 150	4 m	DDP	BSB 35-50 Tuchel 5-pol.	Standard	7T6SK046540050B04
	8 m	DDP	BSB 35-50 Tuchel 5-pol.	Standard	7T6SK086540050B04
	4 m	DDP	BSB 35-50 Tuchel 5-pol.	High Flex Leder	7T6SH046540050B04
	8 m	DDP	BSB 35-50 Tuchel 5-pol.	High Flex Leder	7T6SH086540050B04
ABITIG® 150F	4 m	DDP	BSB 35-50 Tuchel 5-pol.	Standard	7T6FK046540050B04
	8 m	DDP	BSB 35-50 Tuchel 5-pol.	Standard	7T6FK086540050B04
	4 m	DDP	BSB 35-50 Tuchel 5-pol.	High Flex Leder	7T6FH046540050B04
	8 m	DDP	BSB 35-50 Tuchel 5-pol.	High Flex Leder	7T6FH086540050B04

ABITIG® GRIP / ABITIG® GRIP Little-Brennerpreisliste

passend für WIG-Stromquellen des Fabrikates „rs welding systems“

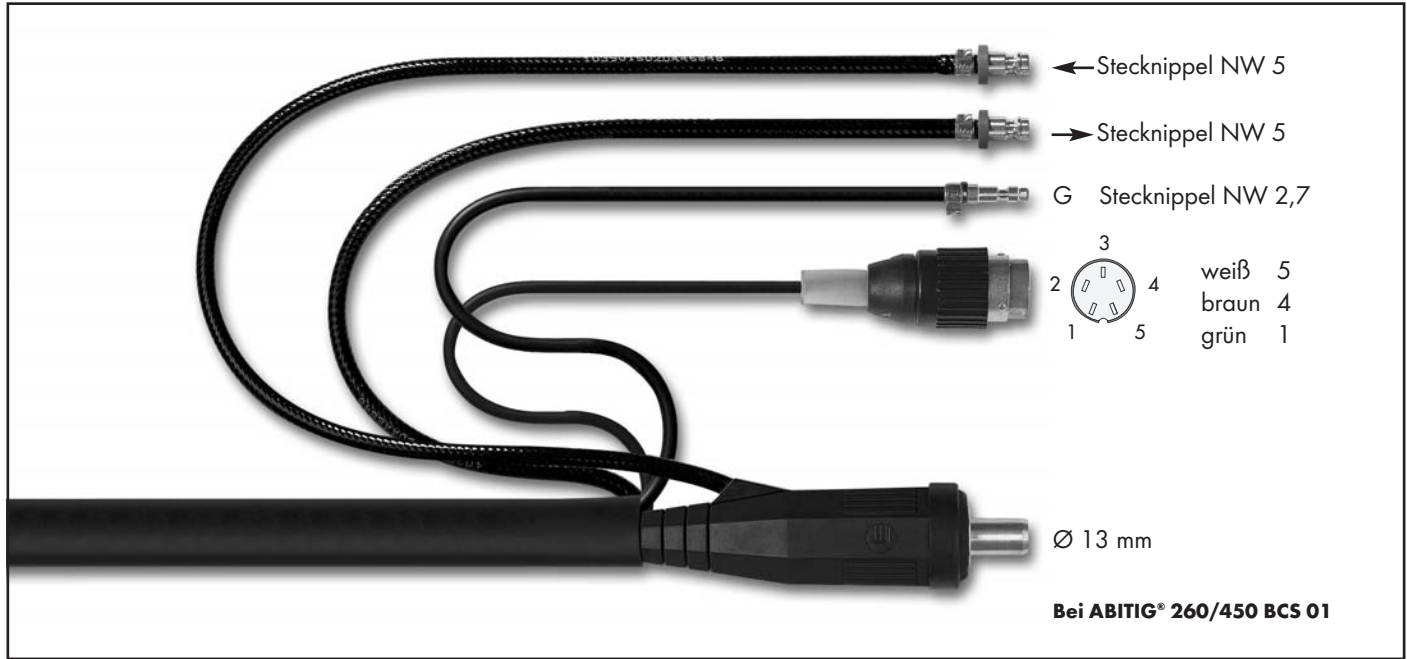

Brennertyp	Länge	Schalterfunktion	maschinenseitiger Anschluss	Schlauchpaketausführung	Bestellnummer
ABITIG® 18	4 m	DD	BSB 35-50 Tuchel 5-pol.	Standard	7S4SK043520050A22
	8 m	DD	BSB 35-50 Tuchel 5-pol.	Standard	7S4SK083520050A22
	4 m	DD	BSB 35-50 Tuchel 5-pol.	High Flex Leder	7S4SH043520050A22
	8 m	DD	BSB 35-50 Tuchel 5-pol.	High Flex Leder	7S4SH083520050A22
ABITIG® 18F	4 m	DD	BSB 35-50 Tuchel 5-pol.	Standard	7S4FK043520050A22
	8 m	DD	BSB 35-50 Tuchel 5-pol.	Standard	7S4FK083520050A22
	4 m	DD	BSB 35-50 Tuchel 5-pol.	High Flex Leder	7S4FH043520050A22
	8 m	DD	BSB 35-50 Tuchel 5-pol.	High Flex Leder	7S4FH083520050A22
ABITIG® 20	4 m	DD	BSB 35-50 Tuchel 5-pol.	Standard	7S5SK043520050A22
	8 m	DD	BSB 35-50 Tuchel 5-pol.	Standard	7S5SK083520050A22
	4 m	DD	BSB 35-50 Tuchel 5-pol.	High Flex Leder	7S5SH043520050A22
	8 m	DD	BSB 35-50 Tuchel 5-pol.	High Flex Leder	7S5SH083520050A22
ABITIG® 20 Little	4 m	DD	BSB 35-50 Tuchel 5-pol.	High Flex Leder	7L5SH043520050A22
	8 m	DD	BSB 35-50 Tuchel 5-pol.	High Flex Leder	7L5SH083520050A22
ABITIG® 20F	4 m	DD	BSB 35-50 Tuchel 5-pol.	Standard	7S5FK043520050A22
	8 m	DD	BSB 35-50 Tuchel 5-pol.	Standard	7S5FK083520050A22
	4 m	DD	BSB 35-50 Tuchel 5-pol.	High Flex Leder	7S5FH043520050A22
	8 m	DD	BSB 35-50 Tuchel 5-pol.	High Flex Leder	7S5FH083520050A22
ABITIG® 20F Little	4 m	DD	BSB 35-50 Tuchel 5-pol.	High Flex Leder	7L5FH043520050A22
	8 m	DD	BSB 35-50 Tuchel 5-pol.	High Flex Leder	7L5FH083520050A22

Technische Änderungen vorbehalten • Verkaufspreise = unverbindliche Preisempfehlung - Angebot freibleibend • © Copyright

ABITIG® GRIP / ABITIG® GRIP Little-Brennerpreisliste

passend für WIG-Stromquellen des Fabrikates „rs welding systems“

Brennertyp	Länge	Schalterfunktion	maschinenseitiger Anschluss	Schlauchpaketausführung	Bestellnummer
ABITIG® 12-1	4 m	DD	BSB 35-50 Tuchel 5-pol.	Standard	7S6SK043520050A22
	8 m	DD	BSB 35-50 Tuchel 5-pol.	Standard	7S6SK083520050A22
	4 m	DD	BSB 35-50 Tuchel 5-pol.	High Flex Leder	7S6SH043520050A22
	8 m	DD	BSB 35-50 Tuchel 5-pol.	High Flex Leder	7S6SH083520050A22
ABITIG® 18SC	4 m	DD	BSB 35-50 Tuchel 5-pol.	Standard	7S7SK043520050A22
	8 m	DD	BSB 35-50 Tuchel 5-pol.	Standard	7S7SK083520050A22
	4 m	DD	BSB 35-50 Tuchel 5-pol.	High Flex Leder	7S7SH043520050A22
	8 m	DD	BSB 35-50 Tuchel 5-pol.	High Flex Leder	7S7SH083520050A22
ABITIG® 24W	4 m	DD	BSB 35-50 Tuchel 5-pol.	Standard	7S9SK043520050A22
	8 m	DD	BSB 35-50 Tuchel 5-pol.	Standard	7S9SK083520050A22
	4 m	DD	BSB 35-50 Tuchel 5-pol.	High Flex Leder	7S9SH043520050A22
	8 m	DD	BSB 35-50 Tuchel 5-pol.	High Flex Leder	7S9SH083520050A22
ABITIG® 24W Little	4 m	DD	BSB 35-50 Tuchel 5-pol.	High Flex Leder	7L9SH043520050A22
	8 m	DD	BSB 35-50 Tuchel 5-pol.	High Flex Leder	7L9SH083520050A22
ABITIG® 450W	4 m	DD	BSB 35-50 Tuchel 5-pol.	Standard	7T5SK043520150A22
	8 m	DD	BSB 35-50 Tuchel 5-pol.	Standard	7T5SK083520150A22
	4 m	DD	BSB 35-50 Tuchel 5-pol.	High Flex Leder	7T5SH043520150A22
	8 m	DD	BSB 35-50 Tuchel 5-pol.	High Flex Leder	7T5SH083520150A22
ABITIG® 260W	4 m	DD	BSB 35-50 Tuchel 5-pol.	Standard	7T7SK043520150A22
	8 m	DD	BSB 35-50 Tuchel 5-pol.	Standard	7T7SK083520150A22
	4 m	DD	BSB 35-50 Tuchel 5-pol.	High Flex Leder	7T7SH043520150A22
	8 m	DD	BSB 35-50 Tuchel 5-pol.	High Flex Leder	7T7SH083520150A22
ABITIG® 260W Little	4 m	DD	BSB 35-50 Tuchel 5-pol.	High Flex Leder	7L7SH043520150A22
	8 m	DD	BSB 35-50 Tuchel 5-pol.	High Flex Leder	7L7SH083520150A22
ABITIG® 450W SC	4 m	DD	BSB 35-50 Tuchel 5-pol.	Standard	
	8 m	DD	BSB 35-50 Tuchel 5-pol.	Standard	
	4 m	DD	BSB 35-50 Tuchel 5-pol.	High Flex Leder	7T8SH043520150A22
	8 m	DD	BSB 35-50 Tuchel 5-pol.	High Flex Leder	7T8SH083520150A22

ABITIG® GRIP / ABITIG® GRIP Little-Brennerpreisliste

passend für WIG-Stromquellen des Fabrikates „rs welding systems“

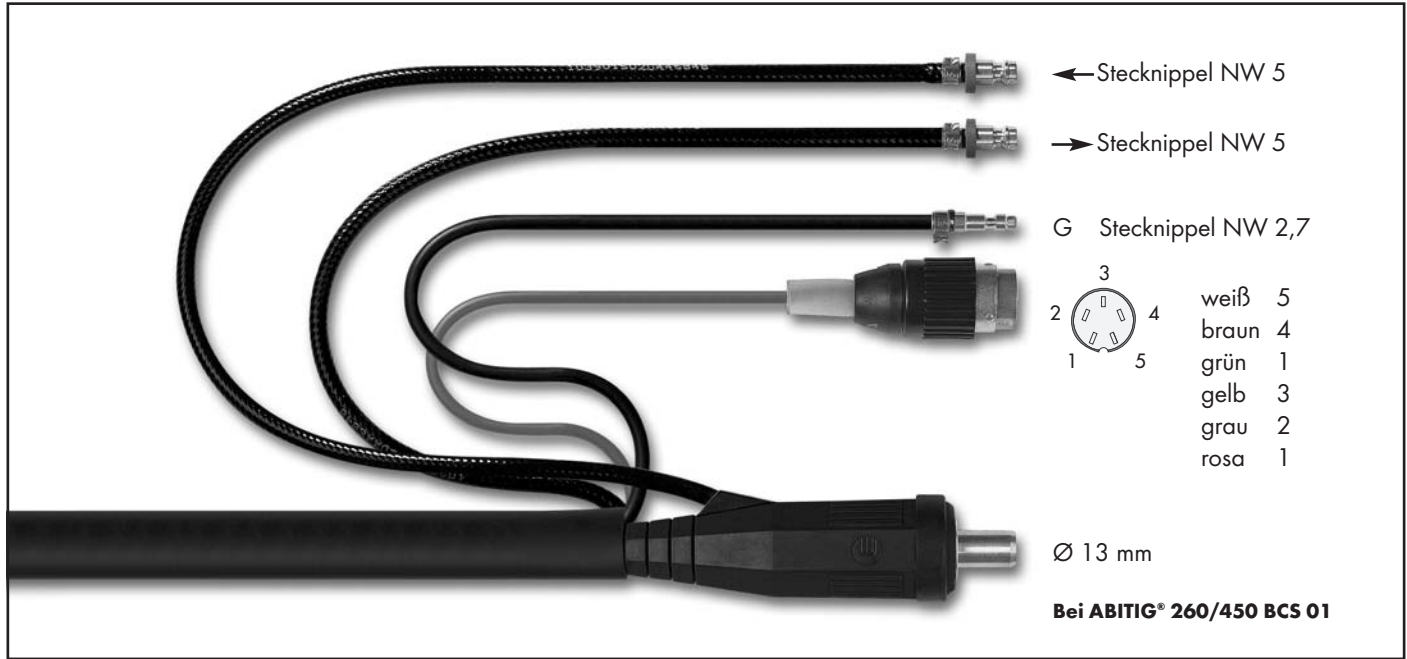

Brennertyp	Länge	Schalterfunktion	maschinenseitiger Anschluss	Schlauchpaketausführung	Bestellnummer
ABITIG® 18	4 m	DDP	BSB 35-50 Tuchel 5-pol.	Standard	7S4SK046540050B22
	8 m	DDP	BSB 35-50 Tuchel 5-pol.	Standard	7S4SK086540050B22
	4 m	DDP	BSB 35-50 Tuchel 5-pol.	High Flex Leder	7S4SH046540050B22
	8 m	DDP	BSB 35-50 Tuchel 5-pol.	High Flex Leder	7S4SH086540050B22
ABITIG® 18F	4 m	DDP	BSB 35-50 Tuchel 5-pol.	Standard	7S4FK046540050B22
	8 m	DDP	BSB 35-50 Tuchel 5-pol.	Standard	7S4FK086540050B22
	4 m	DDP	BSB 35-50 Tuchel 5-pol.	High Flex Leder	7S4FH046540050B22
	8 m	DDP	BSB 35-50 Tuchel 5-pol.	High Flex Leder	7S4FH086540050B22
ABITIG® 20	4 m	DDP	BSB 35-50 Tuchel 5-pol.	Standard	7S5SK046540050B22
	8 m	DDP	BSB 35-50 Tuchel 5-pol.	Standard	7S5SK086540050B22
	4 m	DDP	BSB 35-50 Tuchel 5-pol.	High Flex Leder	7S5SH046540050B22
	8 m	DDP	BSB 35-50 Tuchel 5-pol.	High Flex Leder	7S5SH086540050B22
ABITIG® 20F	4 m	DDP	BSB 35-50 Tuchel 5-pol.	Standard	7S5FK046540050B22
	8 m	DDP	BSB 35-50 Tuchel 5-pol.	Standard	7S5FK086540050B22
	4 m	DDP	BSB 35-50 Tuchel 5-pol.	High Flex Leder	7S5FH046540050B22
	8 m	DDP	BSB 35-50 Tuchel 5-pol.	High Flex Leder	7S5FH086540050B22

Technische Änderungen vorbehalten • Verkaufspreise = unverbindliche Preisempfehlung - Angebot freibleibend • © Copyright

ABITIG® GRIP / ABITIG® GRIP Little-Brennerpreisliste

passend für WIG-Stromquellen des Fabrikates „rs welding systems“

Brennertyp	Länge	Schalterfunktion	maschinenseitiger Anschluss	Schlauchpaketausführung	Bestellnummer
ABITIG® 12-1	4 m	DDP	BSB 35-50 Tuchel 5-pol.	Standard	7S6SK046540050B22
	8 m	DDP	BSB 35-50 Tuchel 5-pol.	Standard	7S6SK086540050B22
	4 m	DDP	BSB 35-50 Tuchel 5-pol.	High Flex Leder	7S6SH046540050B22
	8 m	DDP	BSB 35-50 Tuchel 5-pol.	High Flex Leder	7S6SH086540050B22
ABITIG® 18SC	4 m	DDP	BSB 35-50 Tuchel 5-pol.	Standard	7S7SK046540050B22
	8 m	DDP	BSB 35-50 Tuchel 5-pol.	Standard	7S7SK086540050B22
	4 m	DDP	BSB 35-50 Tuchel 5-pol.	High Flex Leder	7S7SH046540050B22
	8 m	DDP	BSB 35-50 Tuchel 5-pol.	High Flex Leder	7S7SH086540050B22
ABITIG® 24W	4 m	DDP	BSB 35-50 Tuchel 5-pol.	Standard	7S9SK046540050B22
	8 m	DDP	BSB 35-50 Tuchel 5-pol.	Standard	7S9SK086540050B22
	4 m	DDP	BSB 35-50 Tuchel 5-pol.	High Flex Leder	7S9SH046540050B22
	8 m	DDP	BSB 35-50 Tuchel 5-pol.	High Flex Leder	7S9SH086540050B22
ABITIG® 450W	4 m	DDP	BSB 35-50 Tuchel 5-pol.	Standard	7T5SK046540150B22
	8 m	DDP	BSB 35-50 Tuchel 5-pol.	Standard	7T5SK086540150B22
	4 m	DDP	BSB 35-50 Tuchel 5-pol.	High Flex Leder	7T5SH046540150B22
	8 m	DDP	BSB 35-50 Tuchel 5-pol.	High Flex Leder	7T5SH086540150B22
ABITIG® 260W	4 m	DDP	BSB 35-50 Tuchel 5-pol.	Standard	7T7SK046540150B22
	8 m	DDP	BSB 35-50 Tuchel 5-pol.	Standard	7T7SK086540150B22
	4 m	DDP	BSB 35-50 Tuchel 5-pol.	High Flex Leder	7T7SH046540150B22
	8 m	DDP	BSB 35-50 Tuchel 5-pol.	High Flex Leder	7T7SH086540150B22
ABITIG® 450W SC	4 m	DDP	BSB 35-50 Tuchel 5-pol.	Standard	
	8 m	DDP	BSB 35-50 Tuchel 5-pol.	Standard	
	4 m	DDP	BSB 35-50 Tuchel 5-pol.	High Flex Leder	7T8SH046540150B22
	8 m	DDP	BSB 35-50 Tuchel 5-pol.	High Flex Leder	7T8SH086540150B22

ABITIG® GRIP / ABITIG® GRIP Little-Brennerpreisliste

passend für WIG-Stromquellen des Fabrikates „selco“



Brennertyp	Länge	Schalterfunktion	maschinenseitiger Anschluss	Schlauchpaketausführung	Bestellnummer
ABITIG® 9	4 m	ED	ZA 9-pol.	Standard	7S1SK043510799A00
	8 m	ED	ZA 9-pol.	Standard	7S1SK083510799A00
	4 m	ED	ZA 9-pol.	High Flex Leder	7S1SH043510799A00
	8 m	ED	ZA 9-pol.	High Flex Leder	7S1SH083510799A00
ABITIG® 9 Little	4 m	ED	ZA 9-pol.	High Flex Leder	7L1SH043510799A00
	8 m	ED	ZA 9-pol.	High Flex Leder	7L1SH083510799A00
ABITIG® 9F	4 m	ED	ZA 9-pol.	Standard	7S1FK043510799A00
	8 m	ED	ZA 9-pol.	Standard	7S1FK083510799A00
	4 m	ED	ZA 9-pol.	High Flex Leder	7S1FH043510799A00
	8 m	ED	ZA 9-pol.	High Flex Leder	7S1FH083510799A00
ABITIG® 9F Little	4 m	ED	ZA 9-pol.	High Flex Leder	7L1FH043510799A00
	8 m	ED	ZA 9-pol.	High Flex Leder	7L1FH083510799A00
ABITIG® 17	4 m	ED	ZA 9-pol.	Standard	7S2SK043510799A00
	8 m	ED	ZA 9-pol.	Standard	7S2SK083510799A00
	4 m	ED	ZA 9-pol.	High Flex Leder	7S2SH043510799A00
	8 m	ED	ZA 9-pol.	High Flex Leder	7S2SH083510799A00
ABITIG® 17 Little	4 m	ED	ZA 9-pol.	High Flex Leder	7L2SH043510799A00
	8 m	ED	ZA 9-pol.	High Flex Leder	7L2SH083510799A00
ABITIG® 17F	4 m	ED	ZA 9-pol.	Standard	7S2FK043510799A00
	8 m	ED	ZA 9-pol.	Standard	7S2FK083510799A00
	4 m	ED	ZA 9-pol.	High Flex Leder	7S2FH043510799A00
	8 m	ED	ZA 9-pol.	High Flex Leder	7S2FH083510799A00
ABITIG® 17F Little	4 m	ED	ZA 9-pol.	High Flex Leder	7L2FH043510799A00
	8 m	ED	ZA 9-pol.	High Flex Leder	7L2FH083510799A00

Technische Änderungen vorbehalten • Verkaufspreise = unverbindliche Preisempfehlung - Angebot freibleibend • © Copyright

ABITIG® GRIP / ABITIG® GRIP Little-Brennerpreisliste

passend für WIG-Stromquellen des Fabrikates „selco“

Brennertyp	Länge	Schalterfunktion	maschinenseitiger Anschluss	Schlauchpaketausführung	Bestellnummer
ABITIG® 26	4 m	ED	ZA 9-pol.	Standard	7S3SK043510799A00
	8 m	ED	ZA 9-pol.	Standard	7S3SK083510799A00
	4 m	ED	ZA 9-pol.	High Flex Leder	7S3SH043510799A00
	8 m	ED	ZA 9-pol.	High Flex Leder	7S3SH083510799A00
ABITIG® 26F	4 m	ED	ZA 9-pol.	Standard	7S3FK043510799A00
	8 m	ED	ZA 9-pol.	Standard	7S3FK083510799A00
	4 m	ED	ZA 9-pol.	High Flex Leder	7S3FH043510799A00
	8 m	ED	ZA 9-pol.	High Flex Leder	7S3FH083510799A00
ABITIG® 24G	4 m	ED	ZA 9-pol.	Standard	7S8SK043510799A00
	8 m	ED	ZA 9-pol.	Standard	7S8SK083510799A00
	4 m	ED	ZA 9-pol.	High Flex Leder	7S8SH043510799A00
	8 m	ED	ZA 9-pol.	High Flex Leder	7S8SH083510799A00
ABITIG® 24G Little	4 m	ED	ZA 9-pol.	High Flex Leder	7L8SH043510799A00
	8 m	ED	ZA 9-pol.	High Flex Leder	7L8SH083510799A00
ABITIG® 200	4 m	ED	ZA 9-pol.	Standard	7T4SK043510799A00
	8 m	ED	ZA 9-pol.	Standard	7T4SK083510799A00
	4 m	ED	ZA 9-pol.	High Flex Leder	7T4SH043510799A00
	8 m	ED	ZA 9-pol.	High Flex Leder	7T4SH083510799A00
ABITIG® 200F	4 m	ED	ZA 9-pol.	Standard	7T4FK043510799A00
	8 m	ED	ZA 9-pol.	Standard	7T4FK083510799A00
	4 m	ED	ZA 9-pol.	High Flex Leder	7T4FH043510799A00
	8 m	ED	ZA 9-pol.	High Flex Leder	7T4FH083510799A00
ABITIG® 150	4 m	ED	ZA 9-pol.	Standard	7T6SK043510799A00
	8 m	ED	ZA 9-pol.	Standard	7T6SK083510799A00
	4 m	ED	ZA 9-pol.	High Flex Leder	7T6SH043510799A00
	8 m	ED	ZA 9-pol.	High Flex Leder	7T6SH083510799A00
ABITIG® 150 Little	4 m	ED	ZA 9-pol.	High Flex Leder	7L6SH043510799A00
	8 m	ED	ZA 9-pol.	High Flex Leder	7L6SH083510799A00
ABITIG® 150F	4 m	ED	ZA 9-pol.	Standard	7T6FK043510799A00
	8 m	ED	ZA 9-pol.	Standard	7T6FK083510799A00
	4 m	ED	ZA 9-pol.	High Flex Leder	7T6FH043510799A00
	8 m	ED	ZA 9-pol.	High Flex Leder	7T6FH083510799A00
ABITIG® 150F Little	4 m	ED	ZA 9-pol.	High Flex Leder	7L6FH043510799A00
	8 m	ED	ZA 9-pol.	High Flex Leder	7L6FH083510799A00

ABITIG® GRIP / ABITIG® GRIP Little-Brennerpreisliste

passend für WIG-Stromquellen des Fabrikates „selco“

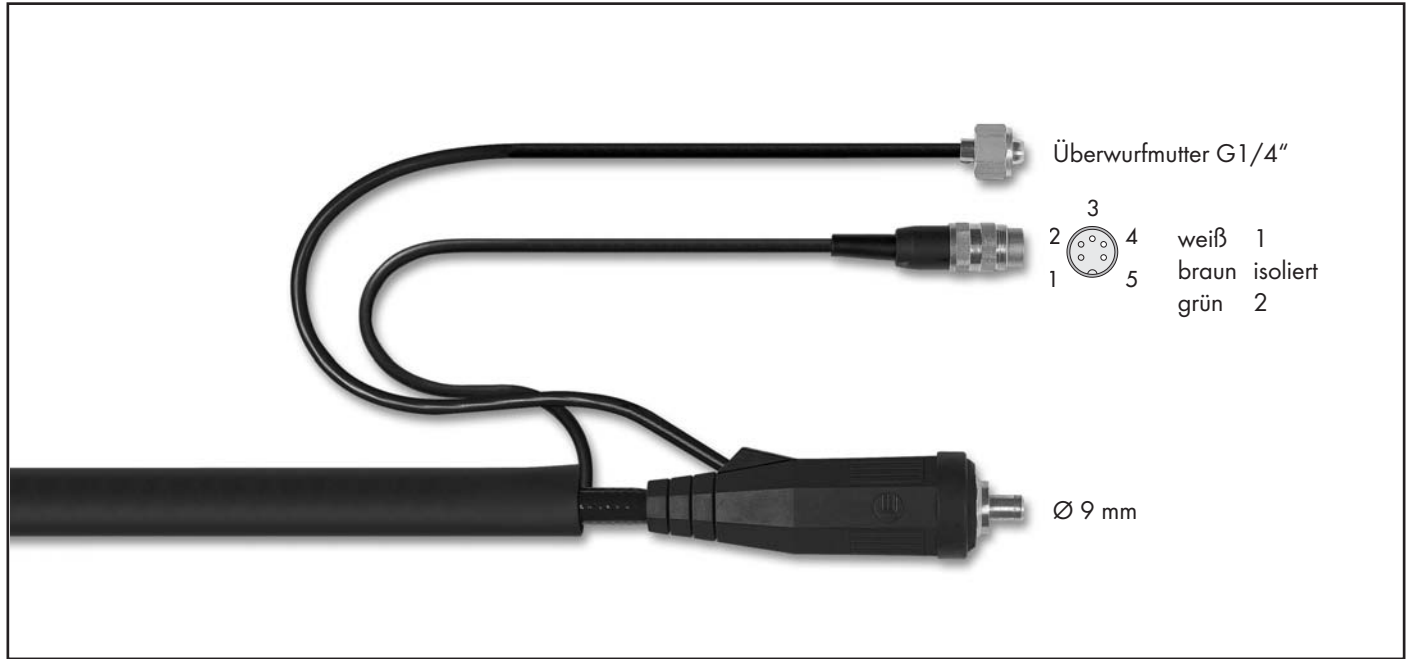

Brennertyp	Länge	Schalterfunktion	maschinenseitiger Anschluss	Schlauchpaketausführung	Bestellnummer
ABITIG® 9	4 m	ED	BSB 10-25 Rundsteckverb. 5-pol.	Standard	7S1SK043512235A01
	8 m	ED	BSB 10-25 Rundsteckverb. 5-pol.	Standard	7S1SK083512235A01
	4 m	ED	BSB 10-25 Rundsteckverb. 5-pol.	High Flex Leder	7S1SH043512235A01
	8 m	ED	BSB 10-25 Rundsteckverb. 5-pol.	High Flex Leder	7S1SH083512235A01
ABITIG® 9 Little	4 m	ED	BSB 10-25 Rundsteckverb. 5-pol.	High Flex Leder	7L1SH043512235A01
	8 m	ED	BSB 10-25 Rundsteckverb. 5-pol.	High Flex Leder	7L1SH083512235A01
ABITIG® 9F	4 m	ED	BSB 10-25 Rundsteckverb. 5-pol.	Standard	7S1FK043512235A01
	8 m	ED	BSB 10-25 Rundsteckverb. 5-pol.	Standard	7S1FK083512235A01
	4 m	ED	BSB 10-25 Rundsteckverb. 5-pol.	High Flex Leder	7S1FH043512235A01
	8 m	ED	BSB 10-25 Rundsteckverb. 5-pol.	High Flex Leder	7S1FH083512235A01
ABITIG® 9F Little	4 m	ED	BSB 10-25 Rundsteckverb. 5-pol.	High Flex Leder	7L1FH043512235A01
	8 m	ED	BSB 10-25 Rundsteckverb. 5-pol.	High Flex Leder	7L1FH083512235A01
ABITIG® 17	4 m	ED	BSB 10-25 Rundsteckverb. 5-pol.	Standard	7S2SK043512235A01
	8 m	ED	BSB 10-25 Rundsteckverb. 5-pol.	Standard	7S2SK083512235A01
	4 m	ED	BSB 10-25 Rundsteckverb. 5-pol.	High Flex Leder	7S2SH043512235A01
	8 m	ED	BSB 10-25 Rundsteckverb. 5-pol.	High Flex Leder	7S2SH083512235A01
ABITIG® 17 Little	4 m	ED	BSB 10-25 Rundsteckverb. 5-pol.	High Flex Leder	7L2SH043512235A01
	8 m	ED	BSB 10-25 Rundsteckverb. 5-pol.	High Flex Leder	7L2SH083512235A01
ABITIG® 17F	4 m	ED	BSB 10-25 Rundsteckverb. 5-pol.	Standard	7S2FK043512235A01
	8 m	ED	BSB 10-25 Rundsteckverb. 5-pol.	Standard	7S2FK083512235A01
	4 m	ED	BSB 10-25 Rundsteckverb. 5-pol.	High Flex Leder	7S2FH043512235A01
	8 m	ED	BSB 10-25 Rundsteckverb. 5-pol.	High Flex Leder	7S2FH083512235A01
ABITIG® 17F Little	4 m	ED	BSB 10-25 Rundsteckverb. 5-pol.	High Flex Leder	7L2FH043512235A01
	8 m	ED	BSB 10-25 Rundsteckverb. 5-pol.	High Flex Leder	7L2FH083512235A01

Technische Änderungen vorbehalten • Verkaufspreise = unverbindliche Preisempfehlung - Angebot freibleibend • © Copyright

ABITIG® GRIP / ABITIG® GRIP Little-Brennerpreisliste

passend für WIG-Stromquellen des Fabrikates „selco“

Brennertyp	Länge	Schalterfunktion	maschinenseitiger Anschluss	Schlauchpaketausführung	Bestellnummer
ABITIG® 26	4 m	ED	BSB 10-25 Rundsteckverb. 5-pol.	Standard	7S3SK043512235A01
	8 m	ED	BSB 10-25 Rundsteckverb. 5-pol.	Standard	7S3SK083512235A01
	4 m	ED	BSB 10-25 Rundsteckverb. 5-pol.	High Flex Leder	7S3SH043512235A01
	8 m	ED	BSB 10-25 Rundsteckverb. 5-pol.	High Flex Leder	7S3SH083512235A01
ABITIG® 26F	4 m	ED	BSB 10-25 Rundsteckverb. 5-pol.	Standard	7S3FK043512235A01
	8 m	ED	BSB 10-25 Rundsteckverb. 5-pol.	Standard	7S3FK083512235A01
	4 m	ED	BSB 10-25 Rundsteckverb. 5-pol.	High Flex Leder	7S3FH043512235A01
	8 m	ED	BSB 10-25 Rundsteckverb. 5-pol.	High Flex Leder	7S3FH083512235A01
ABITIG® 24G	4 m	ED	BSB 10-25 Rundsteckverb. 5-pol.	Standard	7S8SK043512235A01
	8 m	ED	BSB 10-25 Rundsteckverb. 5-pol.	Standard	7S8SK083512235A01
	4 m	ED	BSB 10-25 Rundsteckverb. 5-pol.	High Flex Leder	7S8SH043512235A01
	8 m	ED	BSB 10-25 Rundsteckverb. 5-pol.	High Flex Leder	7S8SH083512235A01
ABITIG® 24G Little	4 m	ED	BSB 10-25 Rundsteckverb. 5-pol.	High Flex Leder	7L8SH043512235A01
	8 m	ED	BSB 10-25 Rundsteckverb. 5-pol.	High Flex Leder	7L8SH083512235A01
ABITIG® 200	4 m	ED	BSB 10-25 Rundsteckverb. 5-pol.	Standard	7T4SK043512235A01
	8 m	ED	BSB 10-25 Rundsteckverb. 5-pol.	Standard	7T4SK083512235A01
	4 m	ED	BSB 10-25 Rundsteckverb. 5-pol.	High Flex Leder	7T4SH043512235A01
	8 m	ED	BSB 10-25 Rundsteckverb. 5-pol.	High Flex Leder	7T4SH083512235A01
ABITIG® 200F	4 m	ED	BSB 10-25 Rundsteckverb. 5-pol.	Standard	7T4FK043512235A01
	8 m	ED	BSB 10-25 Rundsteckverb. 5-pol.	Standard	7T4FK083512235A01
	4 m	ED	BSB 10-25 Rundsteckverb. 5-pol.	High Flex Leder	7T4FH043512235A01
	8 m	ED	BSB 10-25 Rundsteckverb. 5-pol.	High Flex Leder	7T4FH083512235A01
ABITIG® 150	4 m	ED	BSB 10-25 Rundsteckverb. 5-pol.	Standard	7T6SK043512235A01
	8 m	ED	BSB 10-25 Rundsteckverb. 5-pol.	Standard	7T6SK083512235A01
	4 m	ED	BSB 10-25 Rundsteckverb. 5-pol.	High Flex Leder	7T6SH043512235A01
	8 m	ED	BSB 10-25 Rundsteckverb. 5-pol.	High Flex Leder	7T6SH083512235A01
ABITIG® 150 Little	4 m	ED	BSB 10-25 Rundsteckverb. 5-pol.	High Flex Leder	7L6SH043512235A01
	8 m	ED	BSB 10-25 Rundsteckverb. 5-pol.	High Flex Leder	7L6SH083512235A01
ABITIG® 150F	4 m	ED	BSB 10-25 Rundsteckverb. 5-pol.	Standard	7T6FK043512235A01
	8 m	ED	BSB 10-25 Rundsteckverb. 5-pol.	Standard	7T6FK083512235A01
	4 m	ED	BSB 10-25 Rundsteckverb. 5-pol.	High Flex Leder	7T6FH043512235A01
	8 m	ED	BSB 10-25 Rundsteckverb. 5-pol.	High Flex Leder	7T6FH083512235A01
ABITIG® 150F Little	4 m	ED	BSB 10-25 Rundsteckverb. 5-pol.	High Flex Leder	7L6FH043512235A01
	8 m	ED	BSB 10-25 Rundsteckverb. 5-pol.	High Flex Leder	7L6FH083512235A01

ABITIG® GRIP / ABITIG® GRIP Little-Brennerpreisliste

passend für WIG-Stromquellen des Fabrikates „selco“

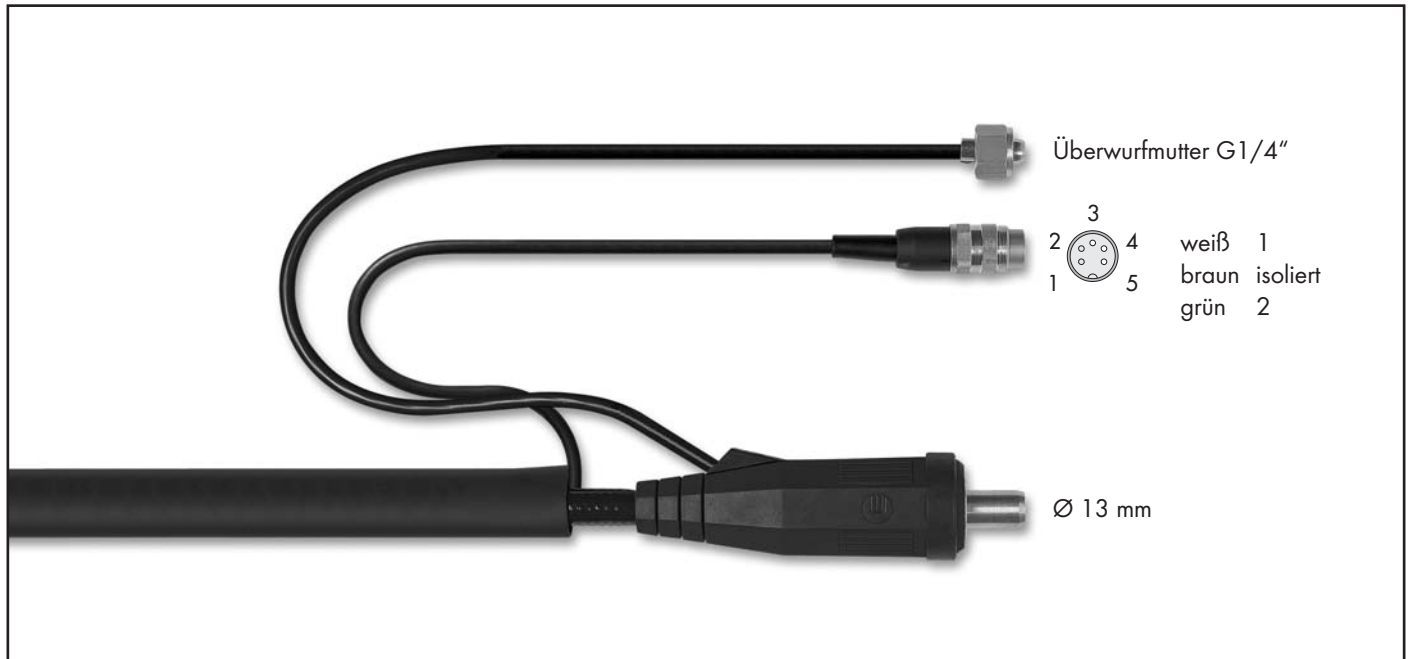

Brennertyp	Länge	Schalterfunktion	maschinenseitiger Anschluss	Schlauchpaketausführung	Bestellnummer
ABITIG® 9	4 m	ED	BSB 35-50 Rundsteckverb. 5-pol.	Standard	7S1SK043510035A01
	8 m	ED	BSB 35-50 Rundsteckverb. 5-pol.	Standard	7S1SK083510035A01
	4 m	ED	BSB 35-50 Rundsteckverb. 5-pol.	High Flex Leder	7S1SH043510035A01
	8 m	ED	BSB 35-50 Rundsteckverb. 5-pol.	High Flex Leder	7S1SH083510035A01
ABITIG® 9 Little	4 m	ED	BSB 35-50 Rundsteckverb. 5-pol.	High Flex Leder	7L1SH043510035A01
	8 m	ED	BSB 35-50 Rundsteckverb. 5-pol.	High Flex Leder	7L1SH083510035A01
ABITIG® 9F	4 m	ED	BSB 35-50 Rundsteckverb. 5-pol.	Standard	7S1FK043510035A01
	8 m	ED	BSB 35-50 Rundsteckverb. 5-pol.	Standard	7S1FK083510035A01
	4 m	ED	BSB 35-50 Rundsteckverb. 5-pol.	High Flex Leder	7S1FH043510035A01
	8 m	ED	BSB 35-50 Rundsteckverb. 5-pol.	High Flex Leder	7S1FH083510035A01
ABITIG® 9F Little	4 m	ED	BSB 35-50 Rundsteckverb. 5-pol.	High Flex Leder	7L1FH043510035A01
	8 m	ED	BSB 35-50 Rundsteckverb. 5-pol.	High Flex Leder	7L1FH083510035A01
ABITIG® 17	4 m	ED	BSB 35-50 Rundsteckverb. 5-pol.	Standard	7S2SK043510035A01
	8 m	ED	BSB 35-50 Rundsteckverb. 5-pol.	Standard	7S2SK083510035A01
	4 m	ED	BSB 35-50 Rundsteckverb. 5-pol.	High Flex Leder	7S2SH043510035A01
	8 m	ED	BSB 35-50 Rundsteckverb. 5-pol.	High Flex Leder	7S2SH083510035A01
ABITIG® 17 Little	4 m	ED	BSB 35-50 Rundsteckverb. 5-pol.	High Flex Leder	7L2SH043510035A01
	8 m	ED	BSB 35-50 Rundsteckverb. 5-pol.	High Flex Leder	7L2SH083510035A01
ABITIG® 17F	4 m	ED	BSB 35-50 Rundsteckverb. 5-pol.	Standard	7S2FK043510035A01
	8 m	ED	BSB 35-50 Rundsteckverb. 5-pol.	Standard	7S2FK083510035A01
	4 m	ED	BSB 35-50 Rundsteckverb. 5-pol.	High Flex Leder	7S2FH043510035A01
	8 m	ED	BSB 35-50 Rundsteckverb. 5-pol.	High Flex Leder	7S2FH083510035A01
ABITIG® 17F Little	4 m	ED	BSB 35-50 Rundsteckverb. 5-pol.	High Flex Leder	7L2FH043510035A01
	8 m	ED	BSB 35-50 Rundsteckverb. 5-pol.	High Flex Leder	7L2FH083510035A01

Technische Änderungen vorbehalten • Verkaufspreise = unverbindliche Preisempfehlung - Angebot freibleibend • © Copyright

ABITIG® GRIP / ABITIG® GRIP Little-Brennerpreisliste

passend für WIG-Stromquellen des Fabrikates „selco“

Brennertyp	Länge	Schalterfunktion	maschinenseitiger Anschluss	Schlauchpaketausführung	Bestellnummer
ABITIG® 26	4 m	ED	BSB 35-50 Rundsteckverb. 5-pol.	Standard	7S3SK043510035A01
	8 m	ED	BSB 35-50 Rundsteckverb. 5-pol.	Standard	7S3SK083510035A01
	4 m	ED	BSB 35-50 Rundsteckverb. 5-pol.	High Flex Leder	7S3SH043510035A01
	8 m	ED	BSB 35-50 Rundsteckverb. 5-pol.	High Flex Leder	7S3SH083510035A01
ABITIG® 26F	4 m	ED	BSB 35-50 Rundsteckverb. 5-pol.	Standard	7S3FK043510035A01
	8 m	ED	BSB 35-50 Rundsteckverb. 5-pol.	Standard	7S3FK083510035A01
	4 m	ED	BSB 35-50 Rundsteckverb. 5-pol.	High Flex Leder	7S3FH043510035A01
	8 m	ED	BSB 35-50 Rundsteckverb. 5-pol.	High Flex Leder	7S3FH083510035A01
ABITIG® 24G	4 m	ED	BSB 35-50 Rundsteckverb. 5-pol.	Standard	7S8SK043510035A01
	8 m	ED	BSB 35-50 Rundsteckverb. 5-pol.	Standard	7S8SK083510035A01
	4 m	ED	BSB 35-50 Rundsteckverb. 5-pol.	High Flex Leder	7S8SH043510035A01
	8 m	ED	BSB 35-50 Rundsteckverb. 5-pol.	High Flex Leder	7S8SH083510035A01
ABITIG® 24G Little	4 m	ED	BSB 35-50 Rundsteckverb. 5-pol.	High Flex Leder	7L8SH043510035A01
	8 m	ED	BSB 35-50 Rundsteckverb. 5-pol.	High Flex Leder	7L8SH083510035A01
ABITIG® 200	4 m	ED	BSB 35-50 Rundsteckverb. 5-pol.	Standard	7T4SK043510035A01
	8 m	ED	BSB 35-50 Rundsteckverb. 5-pol.	Standard	7T4SK083510035A01
	4 m	ED	BSB 35-50 Rundsteckverb. 5-pol.	High Flex Leder	7T4SH043510035A01
	8 m	ED	BSB 35-50 Rundsteckverb. 5-pol.	High Flex Leder	7T4SH083510035A01
ABITIG® 200F	4 m	ED	BSB 35-50 Rundsteckverb. 5-pol.	Standard	7T4FK043510035A01
	8 m	ED	BSB 35-50 Rundsteckverb. 5-pol.	Standard	7T4FK083510035A01
	4 m	ED	BSB 35-50 Rundsteckverb. 5-pol.	High Flex Leder	7T4FH043510035A01
	8 m	ED	BSB 35-50 Rundsteckverb. 5-pol.	High Flex Leder	7T4FH083510035A01
ABITIG® 150	4 m	ED	BSB 35-50 Rundsteckverb. 5-pol.	Standard	7T6SK043510035A01
	8 m	ED	BSB 35-50 Rundsteckverb. 5-pol.	Standard	7T6SK083510035A01
	4 m	ED	BSB 35-50 Rundsteckverb. 5-pol.	High Flex Leder	7T6SH043510035A01
	8 m	ED	BSB 35-50 Rundsteckverb. 5-pol.	High Flex Leder	7T6SH083510035A01
ABITIG® 150 Little	4 m	ED	BSB 35-50 Rundsteckverb. 5-pol.	High Flex Leder	7L6SH043510035A01
	8 m	ED	BSB 35-50 Rundsteckverb. 5-pol.	High Flex Leder	7L6SH083510035A01
ABITIG® 150F	4 m	ED	BSB 35-50 Rundsteckverb. 5-pol.	Standard	7T6FK043510035A01
	8 m	ED	BSB 35-50 Rundsteckverb. 5-pol.	Standard	7T6FK083510035A01
	4 m	ED	BSB 35-50 Rundsteckverb. 5-pol.	High Flex Leder	7T6FH043510035A01
	8 m	ED	BSB 35-50 Rundsteckverb. 5-pol.	High Flex Leder	7T6FH083510035A01
ABITIG® 150F Little	4 m	ED	BSB 35-50 Rundsteckverb. 5-pol.	High Flex Leder	7L6FH043510035A01
	8 m	ED	BSB 35-50 Rundsteckverb. 5-pol.	High Flex Leder	7L6FH083510035A01

ABITIG® GRIP / ABITIG® GRIP Little-Brennerpreisliste

passend für WIG-Stromquellen des Fabrikates „selco“



Brennertyp	Länge	Schalterfunktion	maschinenseitiger Anschluss	Schlauchpaketausführung	Bestellnummer
ABITIG® 9	4 m	ED	BSB 35-50 Tuchel 5-pol.	Standard	7S1SK043510001A01
	8 m	ED	BSB 35-50 Tuchel 5-pol.	Standard	7S1SK083510001A01
	4 m	ED	BSB 35-50 Tuchel 5-pol.	High Flex Leder	7S1SH043510001A01
	8 m	ED	BSB 35-50 Tuchel 5-pol.	High Flex Leder	7S1SH083510001A01
ABITIG® 9 Little	4 m	ED	BSB 35-50 Tuchel 5-pol.	High Flex Leder	7L1SH043510001A01
	8 m	ED	BSB 35-50 Tuchel 5-pol.	High Flex Leder	7L1SH083510001A01
ABITIG® 9F	4 m	ED	BSB 35-50 Tuchel 5-pol.	Standard	7S1FK043510001A01
	8 m	ED	BSB 35-50 Tuchel 5-pol.	Standard	7S1FK083510001A01
	4 m	ED	BSB 35-50 Tuchel 5-pol.	High Flex Leder	7S1FH043510001A01
	8 m	ED	BSB 35-50 Tuchel 5-pol.	High Flex Leder	7S1FH083510001A01
ABITIG® 9F Little	4 m	ED	BSB 35-50 Tuchel 5-pol.	High Flex Leder	7L1FH043510001A01
	8 m	ED	BSB 35-50 Tuchel 5-pol.	High Flex Leder	7L1FH083510001A01
ABITIG® 17	4 m	ED	BSB 35-50 Tuchel 5-pol.	Standard	7S2SK043510001A01
	8 m	ED	BSB 35-50 Tuchel 5-pol.	Standard	7S2SK083510001A01
	4 m	ED	BSB 35-50 Tuchel 5-pol.	High Flex Leder	7S2SH043510001A01
	8 m	ED	BSB 35-50 Tuchel 5-pol.	High Flex Leder	7S2SH083510001A01
ABITIG® 17 Little	4 m	ED	BSB 35-50 Tuchel 5-pol.	High Flex Leder	7L2SH043510001A01
	8 m	ED	BSB 35-50 Tuchel 5-pol.	High Flex Leder	7L2SH083510001A01
ABITIG® 17F	4 m	ED	BSB 35-50 Tuchel 5-pol.	Standard	7S2FK043510001A01
	8 m	ED	BSB 35-50 Tuchel 5-pol.	Standard	7S2FK083510001A01
	4 m	ED	BSB 35-50 Tuchel 5-pol.	High Flex Leder	7S2FH043510001A01
	8 m	ED	BSB 35-50 Tuchel 5-pol.	High Flex Leder	7S2FH083510001A01
ABITIG® 17F Little	4 m	ED	BSB 35-50 Tuchel 5-pol.	High Flex Leder	7L2FH043510001A01
	8 m	ED	BSB 35-50 Tuchel 5-pol.	High Flex Leder	7L2FH083510001A01

Technische Änderungen vorbehalten • Verkaufspreise = unverbindliche Preisempfehlung - Angebot freibleibend • © Copyright

ABITIG® GRIP / ABITIG® GRIP Little-Brennerpreisliste

passend für WIG-Stromquellen des Fabrikates „selco“

Brennertyp	Länge	Schalterfunktion	maschinenseitiger Anschluss	Schlauchpaketausführung	Bestellnummer
ABITIG® 26	4 m	ED	BSB 35-50 Tuchel 5-pol.	Standard	7S3SK043510001A01
	8 m	ED	BSB 35-50 Tuchel 5-pol.	Standard	7S3SK083510001A01
	4 m	ED	BSB 35-50 Tuchel 5-pol.	High Flex Leder	7S3SH043510001A01
	8 m	ED	BSB 35-50 Tuchel 5-pol.	High Flex Leder	7S3SH083510001A01
ABITIG® 26F	4 m	ED	BSB 35-50 Tuchel 5-pol.	Standard	7S3FK043510001A01
	8 m	ED	BSB 35-50 Tuchel 5-pol.	Standard	7S3FK083510001A01
	4 m	ED	BSB 35-50 Tuchel 5-pol.	High Flex Leder	7S3FH043510001A01
	8 m	ED	BSB 35-50 Tuchel 5-pol.	High Flex Leder	7S3FH083510001A01
ABITIG® 24G	4 m	ED	BSB 35-50 Tuchel 5-pol.	Standard	7S8SK043510001A01
	8 m	ED	BSB 35-50 Tuchel 5-pol.	Standard	7S8SK083510001A01
	4 m	ED	BSB 35-50 Tuchel 5-pol.	High Flex Leder	7S8SH043510001A01
	8 m	ED	BSB 35-50 Tuchel 5-pol.	High Flex Leder	7S8SH083510001A01
ABITIG® 24G Little	4 m	ED	BSB 35-50 Tuchel 5-pol.	High Flex Leder	7L8SH043510001A01
	8 m	ED	BSB 35-50 Tuchel 5-pol.	High Flex Leder	7L8SH083510001A01
ABITIG® 200	4 m	ED	BSB 35-50 Tuchel 5-pol.	Standard	7T4SK043510001A01
	8 m	ED	BSB 35-50 Tuchel 5-pol.	Standard	7T4SK083510001A01
	4 m	ED	BSB 35-50 Tuchel 5-pol.	High Flex Leder	7T4SH043510001A01
	8 m	ED	BSB 35-50 Tuchel 5-pol.	High Flex Leder	7T4SH083510001A01
ABITIG® 200F	4 m	ED	BSB 35-50 Tuchel 5-pol.	Standard	7T4FK043510001A01
	8 m	ED	BSB 35-50 Tuchel 5-pol.	Standard	7T4FK083510001A01
	4 m	ED	BSB 35-50 Tuchel 5-pol.	High Flex Leder	7T4FH043510001A01
	8 m	ED	BSB 35-50 Tuchel 5-pol.	High Flex Leder	7T4FH083510001A01
ABITIG® 150	4 m	ED	BSB 35-50 Tuchel 5-pol.	Standard	7T6SK043510001A01
	8 m	ED	BSB 35-50 Tuchel 5-pol.	Standard	7T6SK083510001A01
	4 m	ED	BSB 35-50 Tuchel 5-pol.	High Flex Leder	7T6SH043510001A01
	8 m	ED	BSB 35-50 Tuchel 5-pol.	High Flex Leder	7T6SH083510001A01
ABITIG® 150 Little	4 m	ED	BSB 35-50 Tuchel 5-pol.	High Flex Leder	7L6SH043510001A01
	8 m	ED	BSB 35-50 Tuchel 5-pol.	High Flex Leder	7L6SH083510001A01
ABITIG® 150F	4 m	ED	BSB 35-50 Tuchel 5-pol.	Standard	7T6FK043510001A01
	8 m	ED	BSB 35-50 Tuchel 5-pol.	Standard	7T6FK083510001A01
	4 m	ED	BSB 35-50 Tuchel 5-pol.	High Flex Leder	7T6FH043510001A01
	8 m	ED	BSB 35-50 Tuchel 5-pol.	High Flex Leder	7T6FH083510001A01
ABITIG® 150F Little	4 m	ED	BSB 35-50 Tuchel 5-pol.	High Flex Leder	7L6FH043510001A01
	8 m	ED	BSB 35-50 Tuchel 5-pol.	High Flex Leder	7L6FH083510001A01

ABITIG® GRIP / ABITIG® GRIP Little-Brennerpreisliste

passend für WIG-Stromquellen des Fabrikates „selco“



Brennertyp	Länge	Schalterfunktion	maschinenseitiger Anschluss	Schlauchpaketausführung	Bestellnummer
ABITIG® 18	4 m	ED	BSB 35-50 Tuchel 5-pol.	Standard	7S4SK043510001A11
	8 m	ED	BSB 35-50 Tuchel 5-pol.	Standard	7S4SK083510001A11
	4 m	ED	BSB 35-50 Tuchel 5-pol.	High Flex Leder	7S4SH043510001A11
	8 m	ED	BSB 35-50 Tuchel 5-pol.	High Flex Leder	7S4SH083510001A11
ABITIG® 18F	4 m	ED	BSB 35-50 Tuchel 5-pol.	Standard	7S4FK043510001A11
	8 m	ED	BSB 35-50 Tuchel 5-pol.	Standard	7S4FK083510001A11
	4 m	ED	BSB 35-50 Tuchel 5-pol.	High Flex Leder	7S4FH043510001A11
	8 m	ED	BSB 35-50 Tuchel 5-pol.	High Flex Leder	7S4FH083510001A11
ABITIG® 20	4 m	ED	BSB 35-50 Tuchel 5-pol.	Standard	7S5SK043510001A11
	8 m	ED	BSB 35-50 Tuchel 5-pol.	Standard	7S5SK083510001A11
	4 m	ED	BSB 35-50 Tuchel 5-pol.	High Flex Leder	7S5SH043510001A11
	8 m	ED	BSB 35-50 Tuchel 5-pol.	High Flex Leder	7S5SH083510001A11
ABITIG® 20 Little	4 m	ED	BSB 35-50 Tuchel 5-pol.	High Flex Leder	7L5SH043510001A11
	8 m	ED	BSB 35-50 Tuchel 5-pol.	High Flex Leder	7L5SH083510001A11
ABITIG® 20F	4 m	ED	BSB 35-50 Tuchel 5-pol.	Standard	7S5FK043510001A11
	8 m	ED	BSB 35-50 Tuchel 5-pol.	Standard	7S5FK083510001A11
	4 m	ED	BSB 35-50 Tuchel 5-pol.	High Flex Leder	7S5FH043510001A11
	8 m	ED	BSB 35-50 Tuchel 5-pol.	High Flex Leder	7S5FH083510001A11
ABITIG® 20F Little	4 m	ED	BSB 35-50 Tuchel 5-pol.	High Flex Leder	7L5FH043510001A11
	8 m	ED	BSB 35-50 Tuchel 5-pol.	High Flex Leder	7L5FH083510001A11

Technische Änderungen vorbehalten • Verkaufspreise = unverbindliche Preisempfehlung - Angebot freibleibend • © Copyright

ABITIG® GRIP / ABITIG® GRIP Little-Brennerpreisliste

passend für WIG-Stromquellen des Fabrikates „selco“

Brennertyp	Länge	Schalterfunktion	maschinenseitiger Anschluss	Schlauchpaketausführung	Bestellnummer
ABITIG® 12-1	4 m	ED	BSB 35-50 Tuchel 5-pol.	Standard	7S6SK043510001A11
	8 m	ED	BSB 35-50 Tuchel 5-pol.	Standard	7S6SK083510001A11
	4 m	ED	BSB 35-50 Tuchel 5-pol.	High Flex Leder	7S6SH043510001A11
	8 m	ED	BSB 35-50 Tuchel 5-pol.	High Flex Leder	7S6SH083510001A11
ABITIG® 18SC	4 m	ED	BSB 35-50 Tuchel 5-pol.	Standard	7S7SK043510001A11
	8 m	ED	BSB 35-50 Tuchel 5-pol.	Standard	7S7SK083510001A11
	4 m	ED	BSB 35-50 Tuchel 5-pol.	High Flex Leder	7S7SH043510001A11
	8 m	ED	BSB 35-50 Tuchel 5-pol.	High Flex Leder	7S7SH083510001A11
ABITIG® 24W	4 m	ED	BSB 35-50 Tuchel 5-pol.	Standard	7S9SK043510001A11
	8 m	ED	BSB 35-50 Tuchel 5-pol.	Standard	7S9SK083510001A11
	4 m	ED	BSB 35-50 Tuchel 5-pol.	High Flex Leder	7S9SH043510001A11
	8 m	ED	BSB 35-50 Tuchel 5-pol.	High Flex Leder	7S9SH083510001A11
ABITIG® 24W Little	4 m	ED	BSB 35-50 Tuchel 5-pol.	High Flex Leder	7L9SH043510001A11
	8 m	ED	BSB 35-50 Tuchel 5-pol.	High Flex Leder	7L9SH083510001A11
ABITIG® 450W	4 m	ED	BSB 35-50 Tuchel 5-pol.	Standard	7T5SK043510101A11
	8 m	ED	BSB 35-50 Tuchel 5-pol.	Standard	7T5SK083510101A11
	4 m	ED	BSB 35-50 Tuchel 5-pol.	High Flex Leder	7T5SH043510101A11
	8 m	ED	BSB 35-50 Tuchel 5-pol.	High Flex Leder	7T5SH083510101A11
ABITIG® 260W	4 m	ED	BSB 35-50 Tuchel 5-pol.	Standard	7T7SK043510101A11
	8 m	ED	BSB 35-50 Tuchel 5-pol.	Standard	7T7SK083510101A11
	4 m	ED	BSB 35-50 Tuchel 5-pol.	High Flex Leder	7T7SH043510101A11
	8 m	ED	BSB 35-50 Tuchel 5-pol.	High Flex Leder	7T7SH083510101A11
ABITIG® 260W Little	4 m	ED	BSB 35-50 Tuchel 5-pol.	High Flex Leder	7L7SH043510101A11
	8 m	ED	BSB 35-50 Tuchel 5-pol.	High Flex Leder	7L7SH083510101A11
ABITIG® 450W SC	4 m	ED	BSB 35-50 Tuchel 5-pol.	Standard	
	8 m	ED	BSB 35-50 Tuchel 5-pol.	Standard	
	4 m	ED	BSB 35-50 Tuchel 5-pol.	High Flex Leder	7T8SH043510101A11
	8 m	ED	BSB 35-50 Tuchel 5-pol.	High Flex Leder	7T8SH083510101A11

ABITIG® GRIP / ABITIG® GRIP Little-Brennerpreisliste

passend für WIG-Stromquellen des Fabrikates „stel“



Brennertyp	Länge	Schalterfunktion	maschinenseitiger Anschluss	Schlauchpaketausführung	Bestellnummer
ABITIG® 9	4 m	DD	ZA 9-pol.	Standard	7S1SK043520797B00
	8 m	DD	ZA 9-pol.	Standard	7S1SK083520797B00
	4 m	DD	ZA 9-pol.	High Flex Leder	7S1SH043520797B00
	8 m	DD	ZA 9-pol.	High Flex Leder	7S1SH083520797B00
ABITIG® 9 Little	4 m	DD	ZA 9-pol.	High Flex Leder	7L1SH043520797B00
	8 m	DD	ZA 9-pol.	High Flex Leder	7L1SH083520797B00
ABITIG® 9F	4 m	DD	ZA 9-pol.	Standard	7S1FK043520797B00
	8 m	DD	ZA 9-pol.	Standard	7S1FK083520797B00
	4 m	DD	ZA 9-pol.	High Flex Leder	7S1FH043520797B00
	8 m	DD	ZA 9-pol.	High Flex Leder	7S1FH083520797B00
ABITIG® 9F Little	4 m	DD	ZA 9-pol.	High Flex Leder	7L1FH043520797B00
	8 m	DD	ZA 9-pol.	High Flex Leder	7L1FH083520797B00
ABITIG® 17	4 m	DD	ZA 9-pol.	Standard	7S2SK043520797B00
	8 m	DD	ZA 9-pol.	Standard	7S2SK083520797B00
	4 m	DD	ZA 9-pol.	High Flex Leder	7S2SH043520797B00
	8 m	DD	ZA 9-pol.	High Flex Leder	7S2SH083520797B00
ABITIG® 17 Little	4 m	DD	ZA 9-pol.	High Flex Leder	7L2SH043520797B00
	8 m	DD	ZA 9-pol.	High Flex Leder	7L2SH083520797B00
ABITIG® 17F	4 m	DD	ZA 9-pol.	Standard	7S2FK043520797B00
	8 m	DD	ZA 9-pol.	Standard	7S2FK083520797B00
	4 m	DD	ZA 9-pol.	High Flex Leder	7S2FH043520797B00
	8 m	DD	ZA 9-pol.	High Flex Leder	7S2FH083520797B00
ABITIG® 17F Little	4 m	DD	ZA 9-pol.	High Flex Leder	7L2FH043520797B00
	8 m	DD	ZA 9-pol.	High Flex Leder	7L2FH083520797B00

Technische Änderungen vorbehalten • Verkaufspreise = unverbindliche Preisempfehlung - Angebot freibleibend • © Copyright

ABITIG® GRIP / ABITIG® GRIP Little-Brennerpreisliste

passend für WIG-Stromquellen des Fabrikates „stel“

Brennertyp	Länge	Schalterfunktion	maschinenseitiger Anschluss	Schlauchpaketausführung	Bestellnummer
ABITIG® 26	4 m	DD	ZA 9-pol.	Standard	7S3SK043520797B00
	8 m	DD	ZA 9-pol.	Standard	7S3SK083520797B00
	4 m	DD	ZA 9-pol.	High Flex Leder	7S3SH043520797B00
	8 m	DD	ZA 9-pol.	High Flex Leder	7S3SH083520797B00
ABITIG® 26F	4 m	DD	ZA 9-pol.	Standard	7S3FK043520797B00
	8 m	DD	ZA 9-pol.	Standard	7S3FK083520797B00
	4 m	DD	ZA 9-pol.	High Flex Leder	7S3FH043520797B00
	8 m	DD	ZA 9-pol.	High Flex Leder	7S3FH083520797B00
ABITIG® 24G	4 m	DD	ZA 9-pol.	Standard	7S8SK043520797B00
	8 m	DD	ZA 9-pol.	Standard	7S8SK083520797B00
	4 m	DD	ZA 9-pol.	High Flex Leder	7S8SH043520797B00
	8 m	DD	ZA 9-pol.	High Flex Leder	7S8SH083520797B00
ABITIG® 24G Little	4 m	DD	ZA 9-pol.	High Flex Leder	7L8SH043520797B00
	8 m	DD	ZA 9-pol.	High Flex Leder	7L8SH083520797B00
ABITIG® 200	4 m	DD	ZA 9-pol.	Standard	7T4SK043520797B00
	8 m	DD	ZA 9-pol.	Standard	7T4SK083520797B00
	4 m	DD	ZA 9-pol.	High Flex Leder	7T4SH043520797B00
	8 m	DD	ZA 9-pol.	High Flex Leder	7T4SH083520797B00
ABITIG® 200F	4 m	DD	ZA 9-pol.	Standard	7T4FK043520797B00
	8 m	DD	ZA 9-pol.	Standard	7T4FK083520797B00
	4 m	DD	ZA 9-pol.	High Flex Leder	7T4FH043520797B00
	8 m	DD	ZA 9-pol.	High Flex Leder	7T4FH083520797B00
ABITIG® 150	4 m	DD	ZA 9-pol.	Standard	7T6SK043520797B00
	8 m	DD	ZA 9-pol.	Standard	7T6SK083520797B00
	4 m	DD	ZA 9-pol.	High Flex Leder	7T6SH043520797B00
	8 m	DD	ZA 9-pol.	High Flex Leder	7T6SH083520797B00
ABITIG® 150 Little	4 m	DD	ZA 9-pol.	High Flex Leder	7L6SH043520797B00
	8 m	DD	ZA 9-pol.	High Flex Leder	7L6SH083520797B00
ABITIG® 150F	4 m	DD	ZA 9-pol.	Standard	7T6FK043520797B00
	8 m	DD	ZA 9-pol.	Standard	7T6FK083520797B00
	4 m	DD	ZA 9-pol.	High Flex Leder	7T6FH043520797B00
	8 m	DD	ZA 9-pol.	High Flex Leder	7T6FH083520797B00
ABITIG® 150F Little	4 m	DD	ZA 9-pol.	High Flex Leder	7L6FH043520797B00
	8 m	DD	ZA 9-pol.	High Flex Leder	7L6FH083520797B00

ABITIG® GRIP / ABITIG® GRIP Little-Brennerpreisliste

passend für WIG-Stromquellen des Fabrikates „stel“ (Kombi-Anlage)



Brennertyp	Länge	Schalterfunktion	maschinenseitiger Anschluss	Schlauchpaketausführung	Bestellnummer
ABITIG® 9	4 m	ED	MAG - ZA	Standard	7S1SK043513496A00
	8 m	ED	MAG - ZA	Standard	7S1SK083513496A00
	4 m	ED	MAG - ZA	High Flex Leder	7S1SH043513496A00
	8 m	ED	MAG - ZA	High Flex Leder	7S1SH083513496A00
ABITIG® 9 Little	4 m	ED	MAG - ZA	High Flex Leder	7L1SH043513496A00
	8 m	ED	MAG - ZA	High Flex Leder	7L1SH083513496A00
ABITIG® 9F	4 m	ED	MAG - ZA	Standard	7S1FK043513496A00
	8 m	ED	MAG - ZA	Standard	7S1FK083513496A00
	4 m	ED	MAG - ZA	High Flex Leder	7S1FH043513496A00
	8 m	ED	MAG - ZA	High Flex Leder	7S1FH083513496A00
ABITIG® 9F Little	4 m	ED	MAG - ZA	High Flex Leder	7L1FH043513496A00
	8 m	ED	MAG - ZA	High Flex Leder	7L1FH083513496A00
ABITIG® 17	4 m	ED	MAG - ZA	Standard	7S2SK043513496A00
	8 m	ED	MAG - ZA	Standard	7S2SK083513496A00
	4 m	ED	MAG - ZA	High Flex Leder	7S2SH043513496A00
	8 m	ED	MAG - ZA	High Flex Leder	7S2SH083513496A00
ABITIG® 17 Little	4 m	ED	MAG - ZA	High Flex Leder	7L2SH043513496A00
	8 m	ED	MAG - ZA	High Flex Leder	7L2SH083513496A00
ABITIG® 17F	4 m	ED	MAG - ZA	Standard	7S2FK043513496A00
	8 m	ED	MAG - ZA	Standard	7S2FK083513496A00
	4 m	ED	MAG - ZA	High Flex Leder	7S2FH043513496A00
	8 m	ED	MAG - ZA	High Flex Leder	7S2FH083513496A00
ABITIG® 17F Little	4 m	ED	MAG - ZA	High Flex Leder	7L2FH043513496A00
	8 m	ED	MAG - ZA	High Flex Leder	7L2FH083513496A00

Technische Änderungen vorbehalten • Verkaufspreise = unverbindliche Preisempfehlung - Angebot freibleibend • © Copyright

ABITIG® GRIP / ABITIG® GRIP Little-Brennerpreisliste

passend für WIG-Stromquellen des Fabrikates „stel“ (Kombi-Anlage)

Brennertyp	Länge	Schalterfunktion	maschinenseitiger Anschluss	Schlauchpaketausführung	Bestellnummer
ABITIG® 26	4 m	ED	MAG - ZA	Standard	7S3SK043513496A00
	8 m	ED	MAG - ZA	Standard	7S3SK083513496A00
	4 m	ED	MAG - ZA	High Flex Leder	7S3SH043513496A00
	8 m	ED	MAG - ZA	High Flex Leder	7S3SH083513496A00
ABITIG® 26F	4 m	ED	MAG - ZA	Standard	7S3FK043513496A00
	8 m	ED	MAG - ZA	Standard	7S3FK083513496A00
	4 m	ED	MAG - ZA	High Flex Leder	7S3FH043513496A00
	8 m	ED	MAG - ZA	High Flex Leder	7S3FH083513496A00
ABITIG® 24G	4 m	ED	MAG - ZA	Standard	7S8SK043513496A00
	8 m	ED	MAG - ZA	Standard	7S8SK083513496A00
	4 m	ED	MAG - ZA	High Flex Leder	7S8SH043513496A00
	8 m	ED	MAG - ZA	High Flex Leder	7S8SH083513496A00
ABITIG® 24G Little	4 m	ED	MAG - ZA	High Flex Leder	7L8SH043513496A00
	8 m	ED	MAG - ZA	High Flex Leder	7L8SH083513496A00
ABITIG® 200	4 m	ED	MAG - ZA	Standard	7T4SK043513496A00
	8 m	ED	MAG - ZA	Standard	7T4SK083513496A00
	4 m	ED	MAG - ZA	High Flex Leder	7T4SH043513496A00
	8 m	ED	MAG - ZA	High Flex Leder	7T4SH083513496A00
ABITIG® 200F	4 m	ED	MAG - ZA	Standard	7T4FK043513496A00
	8 m	ED	MAG - ZA	Standard	7T4FK083513496A00
	4 m	ED	MAG - ZA	High Flex Leder	7T4FH043513496A00
	8 m	ED	MAG - ZA	High Flex Leder	7T4FH083513496A00
ABITIG® 150	4 m	ED	MAG - ZA	Standard	7T6SK043513496A00
	8 m	ED	MAG - ZA	Standard	7T6SK083513496A00
	4 m	ED	MAG - ZA	High Flex Leder	7T6SH043513496A00
	8 m	ED	MAG - ZA	High Flex Leder	7T6SH083513496A00
ABITIG® 150 Little	4 m	ED	MAG - ZA	High Flex Leder	7L6SH043513496A00
	8 m	ED	MAG - ZA	High Flex Leder	7L6SH083513496A00
ABITIG® 150F	4 m	ED	MAG - ZA	Standard	7T6FK043513496A00
	8 m	ED	MAG - ZA	Standard	7T6FK083513496A00
	4 m	ED	MAG - ZA	High Flex Leder	7T6FH043513496A00
	8 m	ED	MAG - ZA	High Flex Leder	7T6FH083513496A00
ABITIG® 150F Little	4 m	ED	MAG - ZA	High Flex Leder	7L6FH043513496A00
	8 m	ED	MAG - ZA	High Flex Leder	7L6FH083513496A00

ABITIG® GRIP / ABITIG® GRIP Little-Brennerpreisliste

passend für WIG-Stromquellen des Fabrikates „stel“ Up/Down

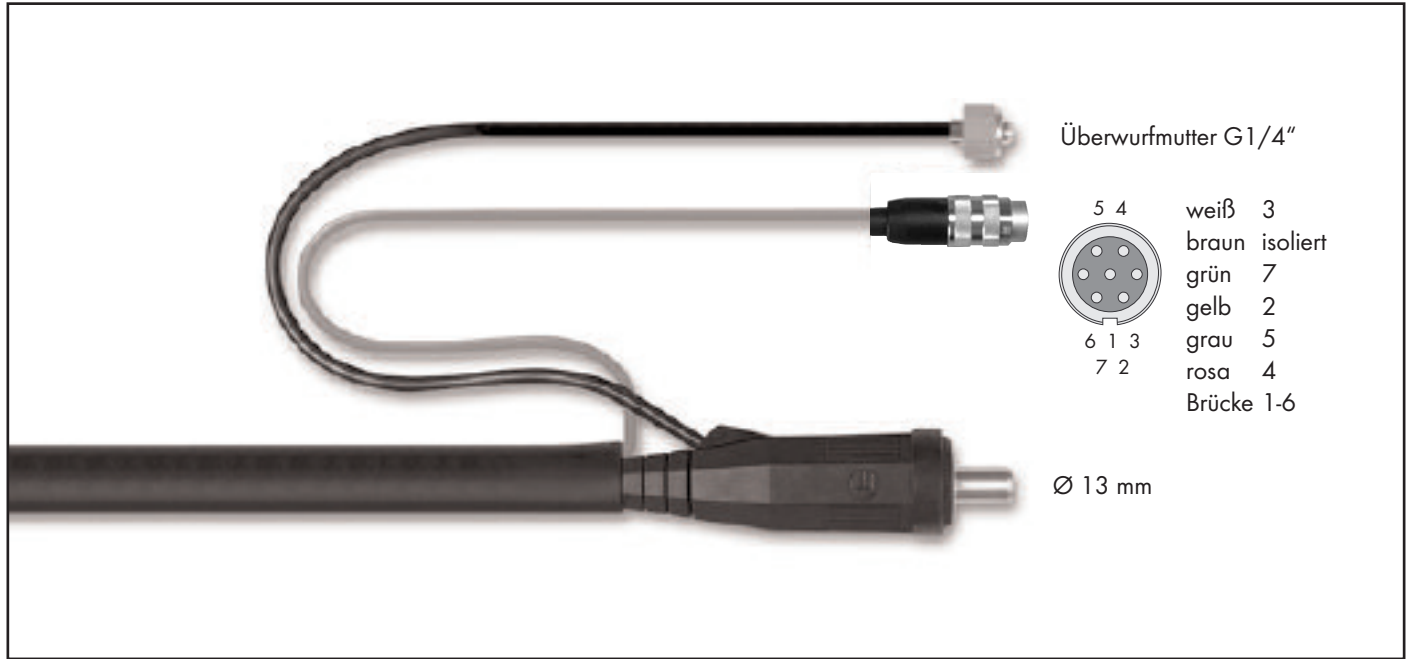

Brennertyp	Länge	Schalterfunktion	maschinenseitiger Anschluss	Schlauchpaketausführung	Bestellnummer
ABITIG® 9	4 m	UD	BSB 35-50 DDK-Stecker 10-pol.	Standard	7S1SK046850048A01
	8 m	UD	BSB 35-50 DDK-Stecker 10-pol.	Standard	7S1SK086850048A01
	4 m	UD	BSB 35-50 DDK-Stecker 10-pol.	High Flex Leder	7S1SH046850048A01
	8 m	UD	BSB 35-50 DDK-Stecker 10-pol.	High Flex Leder	7S1SH086850048A01
ABITIG® 9F	4 m	UD	BSB 35-50 DDK-Stecker 10-pol.	Standard	7S1FK046850048A01
	8 m	UD	BSB 35-50 DDK-Stecker 10-pol.	Standard	7S1FK086850048A01
	4 m	UD	BSB 35-50 DDK-Stecker 10-pol.	High Flex Leder	7S1FH046850048A01
	8 m	UD	BSB 35-50 DDK-Stecker 10-pol.	High Flex Leder	7S1FH086850048A01
ABITIG® 17	4 m	UD	BSB 35-50 DDK-Stecker 10-pol.	Standard	7S2SK046850048A01
	8 m	UD	BSB 35-50 DDK-Stecker 10-pol.	Standard	7S2SK086850048A01
	4 m	UD	BSB 35-50 DDK-Stecker 10-pol.	High Flex Leder	7S2SH046850048A01
	8 m	UD	BSB 35-50 DDK-Stecker 10-pol.	High Flex Leder	7S2SH086850048A01
ABITIG® 17F	4 m	UD	BSB 35-50 DDK-Stecker 10-pol.	Standard	7S2FK046850048A01
	8 m	UD	BSB 35-50 DDK-Stecker 10-pol.	Standard	7S2FK086850048A01
	4 m	UD	BSB 35-50 DDK-Stecker 10-pol.	High Flex Leder	7S2FH046850048A01
	8 m	UD	BSB 35-50 DDK-Stecker 10-pol.	High Flex Leder	7S2FH086850048A01

Technische Änderungen vorbehalten • Verkaufspreise = unverbindliche Preisempfehlung - Angebot freibleibend • © Copyright

ABITIG® GRIP / ABITIG® GRIP Little-Brennerpreisliste

passend für WIG-Stromquellen des Fabrikates „stel“ Up/Down

Brennertyp	Länge	Schalterfunktion	maschinenseitiger Anschluss	Schlauchpaketausführung	Bestellnummer
ABITIG® 26	4 m	UD	BSB 35-50 DDK-Stecker 10-pol.	Standard	7S3SK046850048A01
	8 m	UD	BSB 35-50 DDK-Stecker 10-pol.	Standard	7S3SK086850048A01
	4 m	UD	BSB 35-50 DDK-Stecker 10-pol.	High Flex Leder	7S3SH046850048A01
	8 m	UD	BSB 35-50 DDK-Stecker 10-pol.	High Flex Leder	7S3SH086850048A01
ABITIG® 26F	4 m	UD	BSB 35-50 DDK-Stecker 10-pol.	Standard	7S3FK046850048A01
	8 m	UD	BSB 35-50 DDK-Stecker 10-pol.	Standard	7S3FK086850048A01
	4 m	UD	BSB 35-50 DDK-Stecker 10-pol.	High Flex Leder	7S3FH046850048A01
	8 m	UD	BSB 35-50 DDK-Stecker 10-pol.	High Flex Leder	7S3FH086850048A01
ABITIG® 24G	4 m	UD	BSB 35-50 DDK-Stecker 10-pol.	Standard	7S8SK046850048A01
	8 m	UD	BSB 35-50 DDK-Stecker 10-pol.	Standard	7S8SK086850048A01
	4 m	UD	BSB 35-50 DDK-Stecker 10-pol.	High Flex Leder	7S8SH046850048A01
	8 m	UD	BSB 35-50 DDK-Stecker 10-pol.	High Flex Leder	7S8SH086850048A01
ABITIG® 200	4 m	UD	BSB 35-50 DDK-Stecker 10-pol.	Standard	7T4SK046850048A01
	8 m	UD	BSB 35-50 DDK-Stecker 10-pol.	Standard	7T4SK086850048A01
	4 m	UD	BSB 35-50 DDK-Stecker 10-pol.	High Flex Leder	7T4SH046850048A01
	8 m	UD	BSB 35-50 DDK-Stecker 10-pol.	High Flex Leder	7T4SH086850048A01
ABITIG® 200F	4 m	UD	BSB 35-50 DDK-Stecker 10-pol.	Standard	7T4FK046850048A01
	8 m	UD	BSB 35-50 DDK-Stecker 10-pol.	Standard	7T4FK086850048A01
	4 m	UD	BSB 35-50 DDK-Stecker 10-pol.	High Flex Leder	7T4FH046850048A01
	8 m	UD	BSB 35-50 DDK-Stecker 10-pol.	High Flex Leder	7T4FH086850048A01
ABITIG® 150	4 m	UD	BSB 35-50 DDK-Stecker 10-pol.	Standard	7T6SK046850048A01
	8 m	UD	BSB 35-50 DDK-Stecker 10-pol.	Standard	7T6SK086850048A01
	4 m	UD	BSB 35-50 DDK-Stecker 10-pol.	High Flex Leder	7T6SH046850048A01
	8 m	UD	BSB 35-50 DDK-Stecker 10-pol.	High Flex Leder	7T6SH086850048A01
ABITIG® 150F	4 m	UD	BSB 35-50 DDK-Stecker 10-pol.	Standard	7T6FK046850048A01
	8 m	UD	BSB 35-50 DDK-Stecker 10-pol.	Standard	7T6FK086850048A01
	4 m	UD	BSB 35-50 DDK-Stecker 10-pol.	High Flex Leder	7T6FH046850048A01
	8 m	UD	BSB 35-50 DDK-Stecker 10-pol.	High Flex Leder	7T6FH086850048A01

ABITIG® GRIP / ABITIG® GRIP Little-Brennerpreisliste

passend für WIG-Stromquellen des Fabrikates „stel“



Brennertyp	Länge	Schalterfunktion	maschinenseitiger Anschluss	Schlauchpaketausführung	Bestellnummer
ABITIG® 18	4 m	DD	ZA 9-pol.	Standard	7S4SK043520797B12
	8 m	DD	ZA 9-pol.	Standard	7S4SK083520797B12
	4 m	DD	ZA 9-pol.	High Flex Leder	7S4SH043520797B12
	8 m	DD	ZA 9-pol.	High Flex Leder	7S4SH083520797B12
ABITIG® 18F	4 m	DD	ZA 9-pol.	Standard	7S4FK043520797B12
	8 m	DD	ZA 9-pol.	Standard	7S4FK083520797B12
	4 m	DD	ZA 9-pol.	High Flex Leder	7S4FH043520797B12
	8 m	DD	ZA 9-pol.	High Flex Leder	7S4FH083520797B12
ABITIG® 20	4 m	DD	ZA 9-pol.	Standard	7S5SK043520797B12
	8 m	DD	ZA 9-pol.	Standard	7S5SK083520797B12
	4 m	DD	ZA 9-pol.	High Flex Leder	7S5SH043520797B12
	8 m	DD	ZA 9-pol.	High Flex Leder	7S5SH083520797B12
ABITIG® 20 Little	4 m	DD	ZA 9-pol.	High Flex Leder	7L5SH043520797B12
	8 m	DD	ZA 9-pol.	High Flex Leder	7L5SH083520797B12
ABITIG® 20F	4 m	DD	ZA 9-pol.	Standard	7S5FK043520797B12
	8 m	DD	ZA 9-pol.	Standard	7S5FK083520797B12
	4 m	DD	ZA 9-pol.	High Flex Leder	7S5FH043520797B12
	8 m	DD	ZA 9-pol.	High Flex Leder	7S5FH083520797B12
ABITIG® 20F Little	4 m	DD	ZA 9-pol.	High Flex Leder	7L5FH043520797B12
	8 m	DD	ZA 9-pol.	High Flex Leder	7L5FH083520797B12

Technische Änderungen vorbehalten • Verkaufspreise = unverbindliche Preisempfehlung - Angebot freibleibend • © Copyright

ABITIG® GRIP / ABITIG® GRIP Little-Brennerpreisliste

passend für WIG-Stromquellen des Fabrikates „stel“

Brennertyp	Länge	Schalterfunktion	maschinenseitiger Anschluss	Schlauchpaketausführung	Bestellnummer
ABITIG® 12-1	4 m	DD	ZA 9-pol.	Standard	7S6SK043520797B12
	8 m	DD	ZA 9-pol.	Standard	7S6SK083520797B12
	4 m	DD	ZA 9-pol.	High Flex Leder	7S6SH043520797B12
	8 m	DD	ZA 9-pol.	High Flex Leder	7S6SH083520797B12
ABITIG® 18SC	4 m	DD	ZA 9-pol.	Standard	7S7SK043520797B12
	8 m	DD	ZA 9-pol.	Standard	7S7SK083520797B12
	4 m	DD	ZA 9-pol.	High Flex Leder	7S7SH043520797B12
	8 m	DD	ZA 9-pol.	High Flex Leder	7S7SH083520797B12
ABITIG® 24W	4 m	DD	ZA 9-pol.	Standard	7S9SK043520797B12
	8 m	DD	ZA 9-pol.	Standard	7S9SK083520797B12
	4 m	DD	ZA 9-pol.	High Flex Leder	7S9SH043520797B12
	8 m	DD	ZA 9-pol.	High Flex Leder	7S9SH083520797B12
ABITIG® 24W Little	4 m	DD	ZA 9-pol.	High Flex Leder	7L9SH043520797B12
	8 m	DD	ZA 9-pol.	High Flex Leder	7L9SH083520797B12
ABITIG® 450W	4 m	DD	ZA 9-pol.	Standard	7T5SK043520797B12
	8 m	DD	ZA 9-pol.	Standard	7T5SK083520797B12
	4 m	DD	ZA 9-pol.	High Flex Leder	7T5SH043520797B12
	8 m	DD	ZA 9-pol.	High Flex Leder	7T5SH083520797B12
ABITIG® 260W	4 m	DD	ZA 9-pol.	Standard	7T7SK043520797B12
	8 m	DD	ZA 9-pol.	Standard	7T7SK083520797B12
	4 m	DD	ZA 9-pol.	High Flex Leder	7T7SH043520797B12
	8 m	DD	ZA 9-pol.	High Flex Leder	7T7SH083520797B12
ABITIG® 260W Little	4 m	DD	ZA 9-pol.	High Flex Leder	7L7SH043520797B12
	8 m	DD	ZA 9-pol.	High Flex Leder	7L7SH083520797B12
ABITIG® 450W SC	4 m	DD	ZA 9-pol.	Standard	
	8 m	DD	ZA 9-pol.	Standard	
	4 m	DD	ZA 9-pol.	High Flex Leder	7T8SH043520797B12
	8 m	DD	ZA 9-pol.	High Flex Leder	7T8SH083520797B12

ABITIG® GRIP / ABITIG® GRIP Little-Brennerpreisliste

passend für WIG-Stromquellen des Fabrikates „stel“ Up/Down

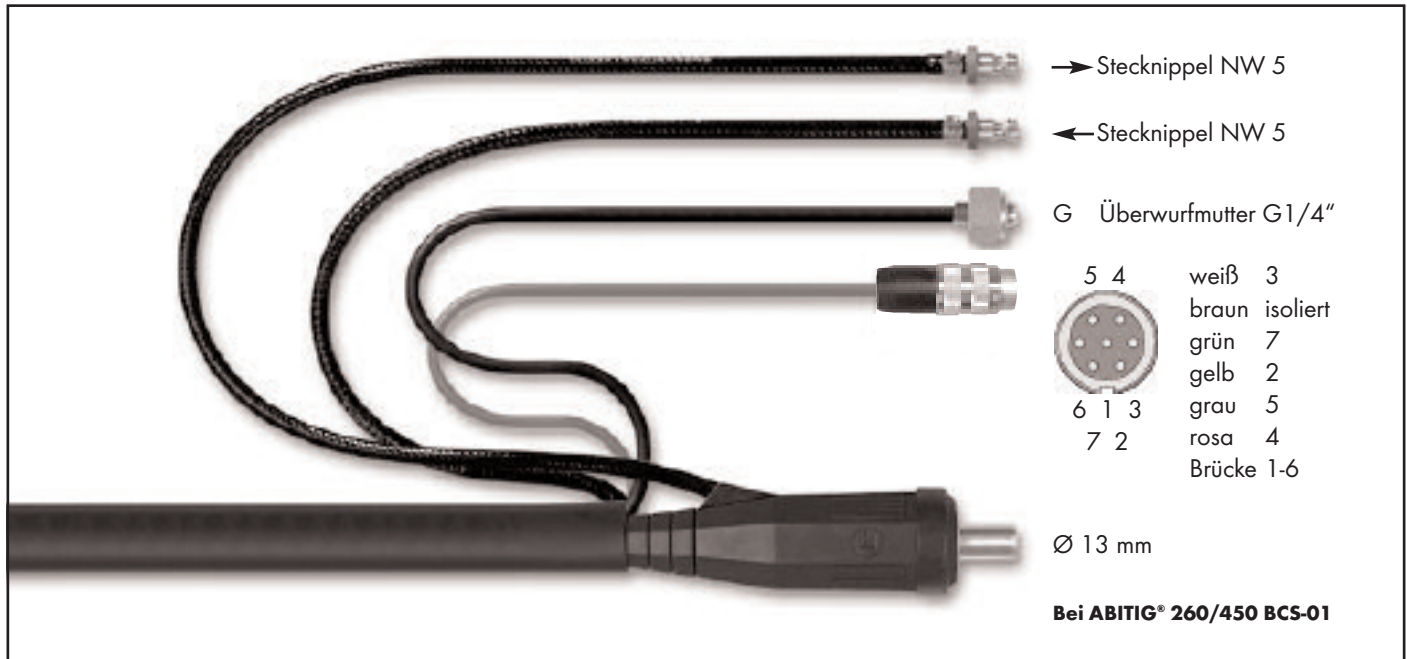

Brennertyp	Länge	Schalterfunktion	maschinenseitiger Anschluss	Schlauchpaketausführung	Bestellnummer
ABITIG® 18	4 m	UD	BSB 35-50 DDK-Stecker 10-pol.	Standard	7S4SK046850048A11
	8 m	UD	BSB 35-50 DDK-Stecker 10-pol.	Standard	7S4SK086850048A11
	4 m	UD	BSB 35-50 DDK-Stecker 10-pol.	High Flex Leder	7S4SH046850048A11
	8 m	UD	BSB 35-50 DDK-Stecker 10-pol.	High Flex Leder	7S4SH086850048A11
ABITIG® 18F	4 m	UD	BSB 35-50 DDK-Stecker 10-pol.	Standard	7S4FK046850048A11
	8 m	UD	BSB 35-50 DDK-Stecker 10-pol.	Standard	7S4FK086850048A11
	4 m	UD	BSB 35-50 DDK-Stecker 10-pol.	High Flex Leder	7S4FH046850048A11
	8 m	UD	BSB 35-50 DDK-Stecker 10-pol.	High Flex Leder	7S4FH086850048A11
ABITIG® 20	4 m	UD	BSB 35-50 DDK-Stecker 10-pol.	Standard	7S5SK046850048A11
	8 m	UD	BSB 35-50 DDK-Stecker 10-pol.	Standard	7S5SK086850048A11
	4 m	UD	BSB 35-50 DDK-Stecker 10-pol.	High Flex Leder	7S5SH046850048A11
	8 m	UD	BSB 35-50 DDK-Stecker 10-pol.	High Flex Leder	7S5SH086850048A11
ABITIG® 20F	4 m	UD	BSB 35-50 DDK-Stecker 10-pol.	Standard	7S5FK046850048A11
	8 m	UD	BSB 35-50 DDK-Stecker 10-pol.	Standard	7S5FK086850048A11
	4 m	UD	BSB 35-50 DDK-Stecker 10-pol.	High Flex Leder	7S5FH046850048A11
	8 m	UD	BSB 35-50 DDK-Stecker 10-pol.	High Flex Leder	7S5FH086850048A11

Technische Änderungen vorbehalten • Verkaufspreise = unverbindliche Preisempfehlung - Angebot freibleibend • © Copyright

ABITIG® GRIP / ABITIG® GRIP Little-Brennerpreisliste

passend für WIG-Stromquellen des Fabrikates „stel“ Up/Down

Brennertyp	Länge	Schalterfunktion	maschinenseitiger Anschluss	Schlauchpaketausführung	Bestellnummer
ABITIG® 12-1	4 m	UD	BSB 35-50 DDK-Stecker 10-pol.	Standard	7S6SK046850048A11
	8 m	UD	BSB 35-50 DDK-Stecker 10-pol.	Standard	7S6SK086850048A11
	4 m	UD	BSB 35-50 DDK-Stecker 10-pol.	High Flex Leder	7S6SH046850048A11
	8 m	UD	BSB 35-50 DDK-Stecker 10-pol.	High Flex Leder	7S6SH086850048A11
ABITIG® 18SC	4 m	UD	BSB 35-50 DDK-Stecker 10-pol.	Standard	7S7SK046850048A11
	8 m	UD	BSB 35-50 DDK-Stecker 10-pol.	Standard	7S7SK086850048A11
	4 m	UD	BSB 35-50 DDK-Stecker 10-pol.	High Flex Leder	7S7SH046850048A11
	8 m	UD	BSB 35-50 DDK-Stecker 10-pol.	High Flex Leder	7S7SH086850048A11
ABITIG® 24W	4 m	UD	BSB 35-50 DDK-Stecker 10-pol.	Standard	7S9SK046850048A11
	8 m	UD	BSB 35-50 DDK-Stecker 10-pol.	Standard	7S9SK086850048A11
	4 m	UD	BSB 35-50 DDK-Stecker 10-pol.	High Flex Leder	7S9SH046850048A11
	8 m	UD	BSB 35-50 DDK-Stecker 10-pol.	High Flex Leder	7S9SH086850048A11
ABITIG® 450W	4 m	UD	BSB 35-50 DDK-Stecker 10-pol.	Standard	7T5SK046850148A11
	8 m	UD	BSB 35-50 DDK-Stecker 10-pol.	Standard	7T5SK086850148A11
	4 m	UD	BSB 35-50 DDK-Stecker 10-pol.	High Flex Leder	7T5SH046850148A11
	8 m	UD	BSB 35-50 DDK-Stecker 10-pol.	High Flex Leder	7T5SH086850148A11
ABITIG® 260W	4 m	UD	BSB 35-50 DDK-Stecker 10-pol.	Standard	7T7SK046850148A11
	8 m	UD	BSB 35-50 DDK-Stecker 10-pol.	Standard	7T7SK086850148A11
	4 m	UD	BSB 35-50 DDK-Stecker 10-pol.	High Flex Leder	7T7SH046850148A11
	8 m	UD	BSB 35-50 DDK-Stecker 10-pol.	High Flex Leder	7T7SH086850148A11
ABITIG® 450W SC	4 m	UD	BSB 35-50 DDK-Stecker 10-pol.	Standard	
	8 m	UD	BSB 35-50 DDK-Stecker 10-pol.	Standard	
	4 m	UD	BSB 35-50 DDK-Stecker 10-pol.	High Flex Leder	7T8SH046850148A11
	8 m	UD	BSB 35-50 DDK-Stecker 10-pol.	High Flex Leder	7T8SH086850148A11

ABITIG® GRIP / ABITIG® GRIP Little-Brennerpreisliste

passend für WIG-Stromquellen des Fabrikates „utp“



Brennertyp	Länge	Schalterfunktion	maschinenseitiger Anschluss	Schlauchpaketausführung	Bestellnummer
ABITIG® 9	4 m	DD	BSB 35-50 Amphenol 4-pol.	Standard	7S1SK043520010B01
	8 m	DD	BSB 35-50 Amphenol 4-pol.	Standard	7S1SK083520010B01
	4 m	DD	BSB 35-50 Amphenol 4-pol.	High Flex Leder	7S1SH043520010B01
	8 m	DD	BSB 35-50 Amphenol 4-pol.	High Flex Leder	7S1SH083520010B01
ABITIG® 9 Little	4 m	DD	BSB 35-50 Amphenol 4-pol.	High Flex Leder	7L1SH043520010B01
	8 m	DD	BSB 35-50 Amphenol 4-pol.	High Flex Leder	7L1SH083520010B01
ABITIG® 9F	4 m	DD	BSB 35-50 Amphenol 4-pol.	Standard	7S1FK043520010B01
	8 m	DD	BSB 35-50 Amphenol 4-pol.	Standard	7S1FK083520010B01
	4 m	DD	BSB 35-50 Amphenol 4-pol.	High Flex Leder	7S1FH043520010B01
	8 m	DD	BSB 35-50 Amphenol 4-pol.	High Flex Leder	7S1FH083520010B01
ABITIG® 9F Little	4 m	DD	BSB 35-50 Amphenol 4-pol.	High Flex Leder	7L1FH043520010B01
	8 m	DD	BSB 35-50 Amphenol 4-pol.	High Flex Leder	7L1FH083520010B01
ABITIG® 17	4 m	DD	BSB 35-50 Amphenol 4-pol.	Standard	7S2SK043520010B01
	8 m	DD	BSB 35-50 Amphenol 4-pol.	Standard	7S2SK083520010B01
	4 m	DD	BSB 35-50 Amphenol 4-pol.	High Flex Leder	7S2SH043520010B01
	8 m	DD	BSB 35-50 Amphenol 4-pol.	High Flex Leder	7S2SH083520010B01
ABITIG® 17 Little	4 m	DD	BSB 35-50 Amphenol 4-pol.	High Flex Leder	7L2SH043520010B01
	8 m	DD	BSB 35-50 Amphenol 4-pol.	High Flex Leder	7L2SH083520010B01
ABITIG® 17F	4 m	DD	BSB 35-50 Amphenol 4-pol.	Standard	7S2FK043520010B01
	8 m	DD	BSB 35-50 Amphenol 4-pol.	Standard	7S2FK083520010B01
	4 m	DD	BSB 35-50 Amphenol 4-pol.	High Flex Leder	7S2FH043520010B01
	8 m	DD	BSB 35-50 Amphenol 4-pol.	High Flex Leder	7S2FH083520010B01
ABITIG® 17F Little	4 m	DD	BSB 35-50 Amphenol 4-pol.	High Flex Leder	7L2FH043520010B01
	8 m	DD	BSB 35-50 Amphenol 4-pol.	High Flex Leder	7L2FH083520010B01

Technische Änderungen vorbehalten • Verkaufspreise = unverbindliche Preisempfehlung - Angebot freibleibend • © Copyright

ABITIG® GRIP / ABITIG® GRIP Little-Brennerpreisliste

passend für WIG-Stromquellen des Fabrikates „utp“

Brennertyp	Länge	Schalterfunktion	maschinenseitiger Anschluss	Schlauchpaket-ausführung	Bestellnummer
ABITIG® 26	4 m	DD	BSB 35-50 Amphenol 4-pol.	Standard	7S3SK043520010B01
	8 m	DD	BSB 35-50 Amphenol 4-pol.	Standard	7S3SK083520010B01
	4 m	DD	BSB 35-50 Amphenol 4-pol.	High Flex Leder	7S3SH043520010B01
	8 m	DD	BSB 35-50 Amphenol 4-pol.	High Flex Leder	7S3SH083520010B01
ABITIG® 26F	4 m	DD	BSB 35-50 Amphenol 4-pol.	Standard	7S3FK043520010B01
	8 m	DD	BSB 35-50 Amphenol 4-pol.	Standard	7S3FK083520010B01
	4 m	DD	BSB 35-50 Amphenol 4-pol.	High Flex Leder	7S3FH043520010B01
	8 m	DD	BSB 35-50 Amphenol 4-pol.	High Flex Leder	7S3FH083520010B01
ABITIG® 24G	4 m	DD	BSB 35-50 Amphenol 4-pol.	Standard	7S8SK043520010B01
	8 m	DD	BSB 35-50 Amphenol 4-pol.	Standard	7S8SK083520010B01
	4 m	DD	BSB 35-50 Amphenol 4-pol.	High Flex Leder	7S8SH043520010B01
	8 m	DD	BSB 35-50 Amphenol 4-pol.	High Flex Leder	7S8SH083520010B01
ABITIG® 24G Little	4 m	DD	BSB 35-50 Amphenol 4-pol.	High Flex Leder	7L8SH043520010B01
	8 m	DD	BSB 35-50 Amphenol 4-pol.	High Flex Leder	7L8SH083520010B01
ABITIG® 200	4 m	DD	BSB 35-50 Amphenol 4-pol.	Standard	7T4SK043520010B01
	8 m	DD	BSB 35-50 Amphenol 4-pol.	Standard	7T4SK083520010B01
	4 m	DD	BSB 35-50 Amphenol 4-pol.	High Flex Leder	7T4SH043520010B01
	8 m	DD	BSB 35-50 Amphenol 4-pol.	High Flex Leder	7T4SH083520010B01
ABITIG® 200F	4 m	DD	BSB 35-50 Amphenol 4-pol.	Standard	7T4FK043520010B01
	8 m	DD	BSB 35-50 Amphenol 4-pol.	Standard	7T4FK083520010B01
	4 m	DD	BSB 35-50 Amphenol 4-pol.	High Flex Leder	7T4FH043520010B01
	8 m	DD	BSB 35-50 Amphenol 4-pol.	High Flex Leder	7T4FH083520010B01
ABITIG® 150	4 m	DD	BSB 35-50 Amphenol 4-pol.	Standard	7T6SK043520010B01
	8 m	DD	BSB 35-50 Amphenol 4-pol.	Standard	7T6SK083520010B01
	4 m	DD	BSB 35-50 Amphenol 4-pol.	High Flex Leder	7T6SH043520010B01
	8 m	DD	BSB 35-50 Amphenol 4-pol.	High Flex Leder	7T6SH083520010B01
ABITIG® 150 Little	4 m	DD	BSB 35-50 Amphenol 4-pol.	High Flex Leder	7L6SH043520010B01
	8 m	DD	BSB 35-50 Amphenol 4-pol.	High Flex Leder	7L6SH083520010B01
ABITIG® 150F	4 m	DD	BSB 35-50 Amphenol 4-pol.	Standard	7T6FK043520010B01
	8 m	DD	BSB 35-50 Amphenol 4-pol.	Standard	7T6FK083520010B01
	4 m	DD	BSB 35-50 Amphenol 4-pol.	High Flex Leder	7T6FH043520010B01
	8 m	DD	BSB 35-50 Amphenol 4-pol.	High Flex Leder	7T6FH083520010B01
ABITIG® 150F Little	4 m	DD	BSB 35-50 Amphenol 4-pol.	High Flex Leder	7L6FH043520010B01
	8 m	DD	BSB 35-50 Amphenol 4-pol.	High Flex Leder	7L6FH083520010B01

ABITIG® GRIP / ABITIG® GRIP Little-Brennerpreisliste

passend für WIG-Stromquellen des Fabrikates „utp“



Brennertyp	Länge	Schalterfunktion	maschinenseitiger Anschluss	Schlauchpaketausführung	Bestellnummer
ABITIG® 9	4 m	ED	BSB 35-50 Amphenol 4-pol.	Standard	7S1SK043510010A01
	8 m	ED	BSB 35-50 Amphenol 4-pol.	Standard	7S1SK083510010A01
	4 m	ED	BSB 35-50 Amphenol 4-pol.	High Flex Leder	7S1SH043510010A01
	8 m	ED	BSB 35-50 Amphenol 4-pol.	High Flex Leder	7S1SH083510010A01
ABITIG® 9 Little	4 m	ED	BSB 35-50 Amphenol 4-pol.	High Flex Leder	7L1SH043510010A01
	8 m	ED	BSB 35-50 Amphenol 4-pol.	High Flex Leder	7L1SH083510010A01
ABITIG® 9F	4 m	ED	BSB 35-50 Amphenol 4-pol.	Standard	7S1FK043510010A01
	8 m	ED	BSB 35-50 Amphenol 4-pol.	Standard	7S1FK083510010A01
	4 m	ED	BSB 35-50 Amphenol 4-pol.	High Flex Leder	7S1FH043510010A01
	8 m	ED	BSB 35-50 Amphenol 4-pol.	High Flex Leder	7S1FH083510010A01
ABITIG® 9F Little	4 m	ED	BSB 35-50 Amphenol 4-pol.	High Flex Leder	7L1FH043510010A01
	8 m	ED	BSB 35-50 Amphenol 4-pol.	High Flex Leder	7L1FH083510010A01
ABITIG® 17	4 m	ED	BSB 35-50 Amphenol 4-pol.	Standard	7S2SK043510010A01
	8 m	ED	BSB 35-50 Amphenol 4-pol.	Standard	7S2SK083510010A01
	4 m	ED	BSB 35-50 Amphenol 4-pol.	High Flex Leder	7S2SH043510010A01
	8 m	ED	BSB 35-50 Amphenol 4-pol.	High Flex Leder	7S2SH083510010A01
ABITIG® 17 Little	4 m	ED	BSB 35-50 Amphenol 4-pol.	High Flex Leder	7L2SH043510010A01
	8 m	ED	BSB 35-50 Amphenol 4-pol.	High Flex Leder	7L2SH083510010A01
ABITIG® 17F	4 m	ED	BSB 35-50 Amphenol 4-pol.	Standard	7S2FK043510010A01
	8 m	ED	BSB 35-50 Amphenol 4-pol.	Standard	7S2FK083510010A01
	4 m	ED	BSB 35-50 Amphenol 4-pol.	High Flex Leder	7S2FH043510010A01
	8 m	ED	BSB 35-50 Amphenol 4-pol.	High Flex Leder	7S2FH083510010A01
ABITIG® 17F Little	4 m	ED	BSB 35-50 Amphenol 4-pol.	High Flex Leder	7L2FH043510010A01
	8 m	ED	BSB 35-50 Amphenol 4-pol.	High Flex Leder	7L2FH083510010A01

Technische Änderungen vorbehalten • Verkaufspreise = unverbindliche Preisempfehlung - Angebot freibleibend • © Copyright

ABITIG® GRIP / ABITIG® GRIP Little-Brennerpreisliste

passend für WIG-Stromquellen des Fabrikates „utp“

Brennertyp	Länge	Schalterfunktion	maschinenseitiger Anschluss	Schlauchpaket-ausführung	Bestellnummer
ABITIG® 26	4 m	ED	BSB 35-50 Amphenol 4-pol.	Standard	7S3SK043510010A01
	8 m	ED	BSB 35-50 Amphenol 4-pol.	Standard	7S3SK083510010A01
	4 m	ED	BSB 35-50 Amphenol 4-pol.	High Flex Leder	7S3SH043510010A01
	8 m	ED	BSB 35-50 Amphenol 4-pol.	High Flex Leder	7S3SH083510010A01
ABITIG® 26F	4 m	ED	BSB 35-50 Amphenol 4-pol.	Standard	7S3FK043510010A01
	8 m	ED	BSB 35-50 Amphenol 4-pol.	Standard	7S3FK083510010A01
	4 m	ED	BSB 35-50 Amphenol 4-pol.	High Flex Leder	7S3FH043510010A01
	8 m	ED	BSB 35-50 Amphenol 4-pol.	High Flex Leder	7S3FH083510010A01
ABITIG® 24G	4 m	ED	BSB 35-50 Amphenol 4-pol.	Standard	7S8SK043510010A01
	8 m	ED	BSB 35-50 Amphenol 4-pol.	Standard	7S8SK083510010A01
	4 m	ED	BSB 35-50 Amphenol 4-pol.	High Flex Leder	7S8SH043510010A01
	8 m	ED	BSB 35-50 Amphenol 4-pol.	High Flex Leder	7S8SH083510010A01
ABITIG® 24G Little	4 m	ED	BSB 35-50 Amphenol 4-pol.	High Flex Leder	7L8SH043510010A01
	8 m	ED	BSB 35-50 Amphenol 4-pol.	High Flex Leder	7L8SH083510010A01
ABITIG® 200	4 m	ED	BSB 35-50 Amphenol 4-pol.	Standard	7T4SK043510010A01
	8 m	ED	BSB 35-50 Amphenol 4-pol.	Standard	7T4SK083510010A01
	4 m	ED	BSB 35-50 Amphenol 4-pol.	High Flex Leder	7T4SH043510010A01
	8 m	ED	BSB 35-50 Amphenol 4-pol.	High Flex Leder	7T4SH083510010A01
ABITIG® 200F	4 m	ED	BSB 35-50 Amphenol 4-pol.	Standard	7T4FK043510010A01
	8 m	ED	BSB 35-50 Amphenol 4-pol.	Standard	7T4FK083510010A01
	4 m	ED	BSB 35-50 Amphenol 4-pol.	High Flex Leder	7T4FH043510010A01
	8 m	ED	BSB 35-50 Amphenol 4-pol.	High Flex Leder	7T4FH083510010A01
ABITIG® 150	4 m	ED	BSB 35-50 Amphenol 4-pol.	Standard	7T6SK043510010A01
	8 m	ED	BSB 35-50 Amphenol 4-pol.	Standard	7T6SK083510010A01
	4 m	ED	BSB 35-50 Amphenol 4-pol.	High Flex Leder	7T6SH043510010A01
	8 m	ED	BSB 35-50 Amphenol 4-pol.	High Flex Leder	7T6SH083510010A01
ABITIG® 150 Little	4 m	ED	BSB 35-50 Amphenol 4-pol.	High Flex Leder	7L6SH043510010A01
	8 m	ED	BSB 35-50 Amphenol 4-pol.	High Flex Leder	7L6SH083510010A01
ABITIG® 150F	4 m	ED	BSB 35-50 Amphenol 4-pol.	Standard	7T6FK043510010A01
	8 m	ED	BSB 35-50 Amphenol 4-pol.	Standard	7T6FK083510010A01
	4 m	ED	BSB 35-50 Amphenol 4-pol.	High Flex Leder	7T6FH043510010A01
	8 m	ED	BSB 35-50 Amphenol 4-pol.	High Flex Leder	7T6FH083510010A01
ABITIG® 150F Little	4 m	ED	BSB 35-50 Amphenol 4-pol.	High Flex Leder	7L6FH043510010A01
	8 m	ED	BSB 35-50 Amphenol 4-pol.	High Flex Leder	7L6FH083510010A01

ABITIG® GRIP / ABITIG® GRIP Little-Brennerpreisliste

passend für WIG-Stromquellen des Fabrikates „utp“



Brennertyp	Länge	Schalterfunktion	maschinenseitiger Anschluss	Schlauchpaketausführung	Bestellnummer
ABITIG® 9	4 m	ED	BSB 35-50 Tuchel 5-pol.	Standard	7S1SK043510002A01
	8 m	ED	BSB 35-50 Tuchel 5-pol.	Standard	7S1SK083510002A01
	4 m	ED	BSB 35-50 Tuchel 5-pol.	High Flex Leder	7S1SH043510002A01
	8 m	ED	BSB 35-50 Tuchel 5-pol.	High Flex Leder	7S1SH083510002A01
ABITIG® 9 Little	4 m	ED	BSB 35-50 Tuchel 5-pol.	High Flex Leder	7L1SH043510002A01
	8 m	ED	BSB 35-50 Tuchel 5-pol.	High Flex Leder	7L1SH083510002A01
ABITIG® 9F	4 m	ED	BSB 35-50 Tuchel 5-pol.	Standard	7S1FK043510002A01
	8 m	ED	BSB 35-50 Tuchel 5-pol.	Standard	7S1FK083510002A01
	4 m	ED	BSB 35-50 Tuchel 5-pol.	High Flex Leder	7S1FH043510002A01
	8 m	ED	BSB 35-50 Tuchel 5-pol.	High Flex Leder	7S1FH083510002A01
ABITIG® 9F Little	4 m	ED	BSB 35-50 Tuchel 5-pol.	High Flex Leder	7L1FH043510002A01
	8 m	ED	BSB 35-50 Tuchel 5-pol.	High Flex Leder	7L1FH083510002A01
ABITIG® 17	4 m	ED	BSB 35-50 Tuchel 5-pol.	Standard	7S2SK043510002A01
	8 m	ED	BSB 35-50 Tuchel 5-pol.	Standard	7S2SK083510002A01
	4 m	ED	BSB 35-50 Tuchel 5-pol.	High Flex Leder	7S2SH043510002A01
	8 m	ED	BSB 35-50 Tuchel 5-pol.	High Flex Leder	7S2SH083510002A01
ABITIG® 17 Little	4 m	ED	BSB 35-50 Tuchel 5-pol.	High Flex Leder	7L2SH043510002A01
	8 m	ED	BSB 35-50 Tuchel 5-pol.	High Flex Leder	7L2SH083510002A01
ABITIG® 17F	4 m	ED	BSB 35-50 Tuchel 5-pol.	Standard	7S2FK043510002A01
	8 m	ED	BSB 35-50 Tuchel 5-pol.	Standard	7S2FK083510002A01
	4 m	ED	BSB 35-50 Tuchel 5-pol.	High Flex Leder	7S2FH043510002A01
	8 m	ED	BSB 35-50 Tuchel 5-pol.	High Flex Leder	7S2FH083510002A01
ABITIG® 17F Little	4 m	ED	BSB 35-50 Tuchel 5-pol.	High Flex Leder	7L2FH043510002A01
	8 m	ED	BSB 35-50 Tuchel 5-pol.	High Flex Leder	7L2FH083510002A01

Technische Änderungen vorbehalten • Verkaufspreise = unverbindliche Preisempfehlung - Angebot freibleibend • © Copyright

ABITIG® GRIP / ABITIG® GRIP Little-Brennerpreisliste

passend für WIG-Stromquellen des Fabrikates „utp“

Brennertyp	Länge	Schalterfunktion	maschinenseitiger Anschluss	Schlauchpaketausführung	Bestellnummer
ABITIG® 26	4 m	ED	BSB 35-50 Tuchel 5-pol.	Standard	7S3SK043510002A01
	8 m	ED	BSB 35-50 Tuchel 5-pol.	Standard	7S3SK083510002A01
	4 m	ED	BSB 35-50 Tuchel 5-pol.	High Flex Leder	7S3SH043510002A01
	8 m	ED	BSB 35-50 Tuchel 5-pol.	High Flex Leder	7S3SH083510002A01
ABITIG® 26F	4 m	ED	BSB 35-50 Tuchel 5-pol.	Standard	7S3FK043510002A01
	8 m	ED	BSB 35-50 Tuchel 5-pol.	Standard	7S3FK083510002A01
	4 m	ED	BSB 35-50 Tuchel 5-pol.	High Flex Leder	7S3FH043510002A01
	8 m	ED	BSB 35-50 Tuchel 5-pol.	High Flex Leder	7S3FH083510002A01
ABITIG® 24G	4 m	ED	BSB 35-50 Tuchel 5-pol.	Standard	7S8SK043510002A01
	8 m	ED	BSB 35-50 Tuchel 5-pol.	Standard	7S8SK083510002A01
	4 m	ED	BSB 35-50 Tuchel 5-pol.	High Flex Leder	7S8SH043510002A01
	8 m	ED	BSB 35-50 Tuchel 5-pol.	High Flex Leder	7S8SH083510002A01
ABITIG® 24G Little	4 m	ED	BSB 35-50 Tuchel 5-pol.	High Flex Leder	7L8SH043510002A01
	8 m	ED	BSB 35-50 Tuchel 5-pol.	High Flex Leder	7L8SH083510002A01
ABITIG® 200	4 m	ED	BSB 35-50 Tuchel 5-pol.	Standard	7T4SK043510002A01
	8 m	ED	BSB 35-50 Tuchel 5-pol.	Standard	7T4SK083510002A01
	4 m	ED	BSB 35-50 Tuchel 5-pol.	High Flex Leder	7T4SH043510002A01
	8 m	ED	BSB 35-50 Tuchel 5-pol.	High Flex Leder	7T4SH083510002A01
ABITIG® 200F	4 m	ED	BSB 35-50 Tuchel 5-pol.	Standard	7T4FK043510002A01
	8 m	ED	BSB 35-50 Tuchel 5-pol.	Standard	7T4FK083510002A01
	4 m	ED	BSB 35-50 Tuchel 5-pol.	High Flex Leder	7T4FH043510002A01
	8 m	ED	BSB 35-50 Tuchel 5-pol.	High Flex Leder	7T4FH083510002A01
ABITIG® 150	4 m	ED	BSB 35-50 Tuchel 5-pol.	Standard	7T6SK043510002A01
	8 m	ED	BSB 35-50 Tuchel 5-pol.	Standard	7T6SK083510002A01
	4 m	ED	BSB 35-50 Tuchel 5-pol.	High Flex Leder	7T6SH043510002A01
	8 m	ED	BSB 35-50 Tuchel 5-pol.	High Flex Leder	7T6SH083510002A01
ABITIG® 150 Little	4 m	ED	BSB 35-50 Tuchel 5-pol.	High Flex Leder	7L6SH043510002A01
	8 m	ED	BSB 35-50 Tuchel 5-pol.	High Flex Leder	7L6SH083510002A01
ABITIG® 150F	4 m	ED	BSB 35-50 Tuchel 5-pol.	Standard	7T6FK043510002A01
	8 m	ED	BSB 35-50 Tuchel 5-pol.	Standard	7T6FK083510002A01
	4 m	ED	BSB 35-50 Tuchel 5-pol.	High Flex Leder	7T6FH043510002A01
	8 m	ED	BSB 35-50 Tuchel 5-pol.	High Flex Leder	7T6FH083510002A01
ABITIG® 150F Little	4 m	ED	BSB 35-50 Tuchel 5-pol.	High Flex Leder	7L6FH043510002A01
	8 m	ED	BSB 35-50 Tuchel 5-pol.	High Flex Leder	7L6FH083510002A01

ABITIG® GRIP / ABITIG® GRIP Little-Brennerpreisliste

passend für WIG-Stromquellen des Fabrikates „utp“

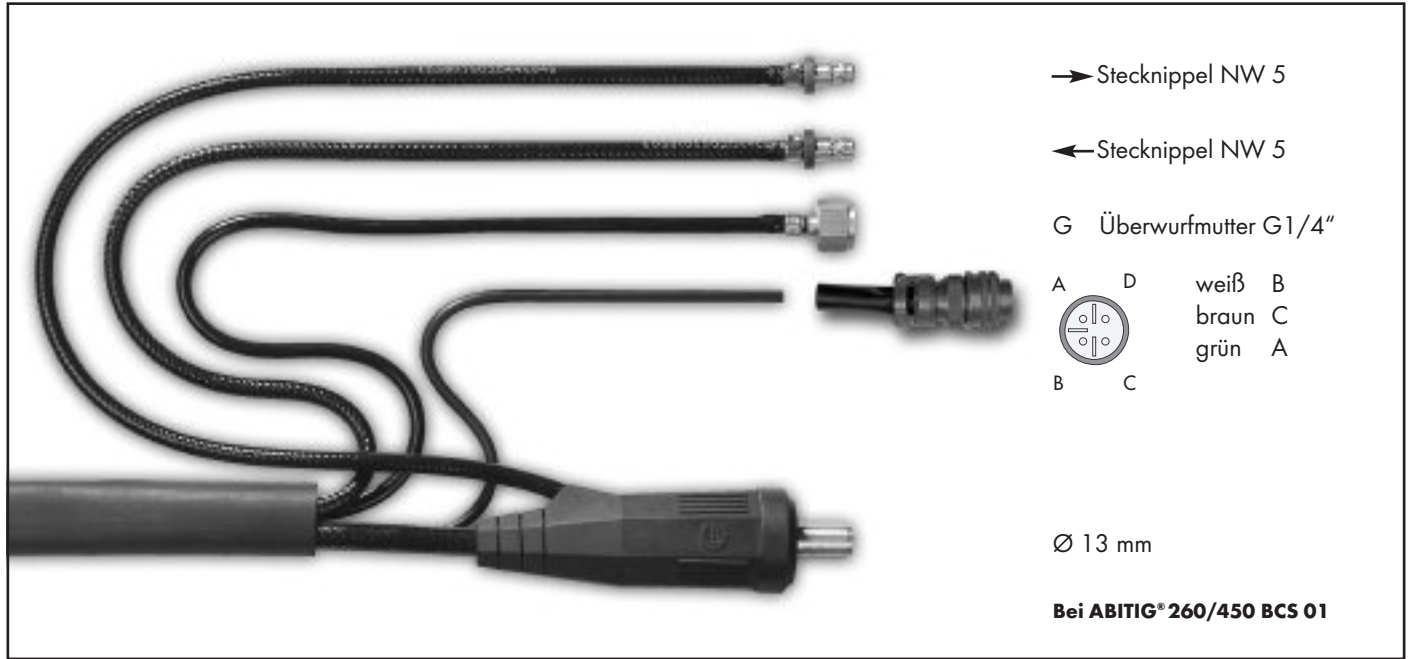

Brennertyp	Länge	Schalterfunktion	maschinenseitiger Anschluss	Schlauchpaketausführung	Bestellnummer
ABITIG® 18	4 m	DD	BSB 35-50 Amphenol 4-pol.	Standard	7S4SK043520010B11
	8 m	DD	BSB 35-50 Amphenol 4-pol.	Standard	7S4SK083520010B11
	4 m	DD	BSB 35-50 Amphenol 4-pol.	High Flex Leder	7S4SH043520010B11
	8 m	DD	BSB 35-50 Amphenol 4-pol.	High Flex Leder	7S4SH083520010B11
ABITIG® 18F	4 m	DD	BSB 35-50 Amphenol 4-pol.	Standard	7S4FK043520010B11
	8 m	DD	BSB 35-50 Amphenol 4-pol.	Standard	7S4FK083520010B11
	4 m	DD	BSB 35-50 Amphenol 4-pol.	High Flex Leder	7S4FH043520010B11
	8 m	DD	BSB 35-50 Amphenol 4-pol.	High Flex Leder	7S4FH083520010B11
ABITIG® 20	4 m	DD	BSB 35-50 Amphenol 4-pol.	Standard	7S5SK043520010B11
	8 m	DD	BSB 35-50 Amphenol 4-pol.	Standard	7S5SK083520010B11
	4 m	DD	BSB 35-50 Amphenol 4-pol.	High Flex Leder	7S5SH043520010B11
	8 m	DD	BSB 35-50 Amphenol 4-pol.	High Flex Leder	7S5SH083520010B11
ABITIG® 20 Little	4 m	DD	BSB 35-50 Amphenol 4-pol.	High Flex Leder	7L5SH043520010B11
	8 m	DD	BSB 35-50 Amphenol 4-pol.	High Flex Leder	7L5SH083520010B11
ABITIG® 20F	4 m	DD	BSB 35-50 Amphenol 4-pol.	Standard	7S5FK043520010B11
	8 m	DD	BSB 35-50 Amphenol 4-pol.	Standard	7S5FK083520010B11
	4 m	DD	BSB 35-50 Amphenol 4-pol.	High Flex Leder	7S5FH043520010B11
	8 m	DD	BSB 35-50 Amphenol 4-pol.	High Flex Leder	7S5FH083520010B11
ABITIG® 20F Little	4 m	DD	BSB 35-50 Amphenol 4-pol.	High Flex Leder	7L5FH043520010B11
	8 m	DD	BSB 35-50 Amphenol 4-pol.	High Flex Leder	7L5FH083520010B11

Technische Änderungen vorbehalten • Verkaufspreise = unverbindliche Preisempfehlung - Angebot freibleibend • © Copyright

ABITIG® GRIP / ABITIG® GRIP Little-Brennerpreisliste

passend für WIG-Stromquellen des Fabrikates „utp“

Brennertyp	Länge	Schalterfunktion	maschinenseitiger Anschluss	Schlauchpaket-ausführung	Bestellnummer
ABITIG® 12-1	4 m	DD	BSB 35-50 Amphenol 4-pol.	Standard	7S6SK043520010B11
	8 m	DD	BSB 35-50 Amphenol 4-pol.	Standard	7S6SK083520010B11
	4 m	DD	BSB 35-50 Amphenol 4-pol.	High Flex Leder	7S6SH043520010B11
	8 m	DD	BSB 35-50 Amphenol 4-pol.	High Flex Leder	7S6SH083520010B11
ABITIG® 18SC	4 m	DD	BSB 35-50 Amphenol 4-pol.	Standard	7S7SK043520010B11
	8 m	DD	BSB 35-50 Amphenol 4-pol.	Standard	7S7SK083520010B11
	4 m	DD	BSB 35-50 Amphenol 4-pol.	High Flex Leder	7S7SH043520010B11
	8 m	DD	BSB 35-50 Amphenol 4-pol.	High Flex Leder	7S7SH083520010B11
ABITIG® 24W	4 m	DD	BSB 35-50 Amphenol 4-pol.	Standard	7S9SK043520010B11
	8 m	DD	BSB 35-50 Amphenol 4-pol.	Standard	7S9SK083520010B11
	4 m	DD	BSB 35-50 Amphenol 4-pol.	High Flex Leder	7S9SH043520010B11
	8 m	DD	BSB 35-50 Amphenol 4-pol.	High Flex Leder	7S9SH083520010B11
ABITIG® 24W Little	4 m	DD	BSB 35-50 Amphenol 4-pol.	High Flex Leder	7L9SH043520010B11
	8 m	DD	BSB 35-50 Amphenol 4-pol.	High Flex Leder	7L9SH083520010B11
ABITIG® 450W	4 m	DD	BSB 35-50 Amphenol 4-pol.	Standard	7T5SK043520110B11
	8 m	DD	BSB 35-50 Amphenol 4-pol.	Standard	7T5SK083520110B11
	4 m	DD	BSB 35-50 Amphenol 4-pol.	High Flex Leder	7T5SH043520110B11
	8 m	DD	BSB 35-50 Amphenol 4-pol.	High Flex Leder	7T5SH083520110B11
ABITIG® 260W	4 m	DD	BSB 35-50 Amphenol 4-pol.	Standard	7T7SK043520110B11
	8 m	DD	BSB 35-50 Amphenol 4-pol.	Standard	7T7SK083520110B11
	4 m	DD	BSB 35-50 Amphenol 4-pol.	High Flex Leder	7T7SH043520110B11
	8 m	DD	BSB 35-50 Amphenol 4-pol.	High Flex Leder	7T7SH083520110B11
ABITIG® 260W Little	4 m	DD	BSB 35-50 Amphenol 4-pol.	High Flex Leder	7L7SH043520110B11
	8 m	DD	BSB 35-50 Amphenol 4-pol.	High Flex Leder	7L7SH083520110B11
ABITIG® 450W SC	4 m	DD	BSB 35-50 Amphenol 4-pol.	Standard	
	8 m	DD	BSB 35-50 Amphenol 4-pol.	Standard	
	4 m	DD	BSB 35-50 Amphenol 4-pol.	High Flex Leder	7T8SH043520110B11
	8 m	DD	BSB 35-50 Amphenol 4-pol.	High Flex Leder	7T8SH083520110B11

ABITIG® GRIP / ABITIG® GRIP Little-Brennerpreisliste

passend für WIG-Stromquellen des Fabrikates „utp“

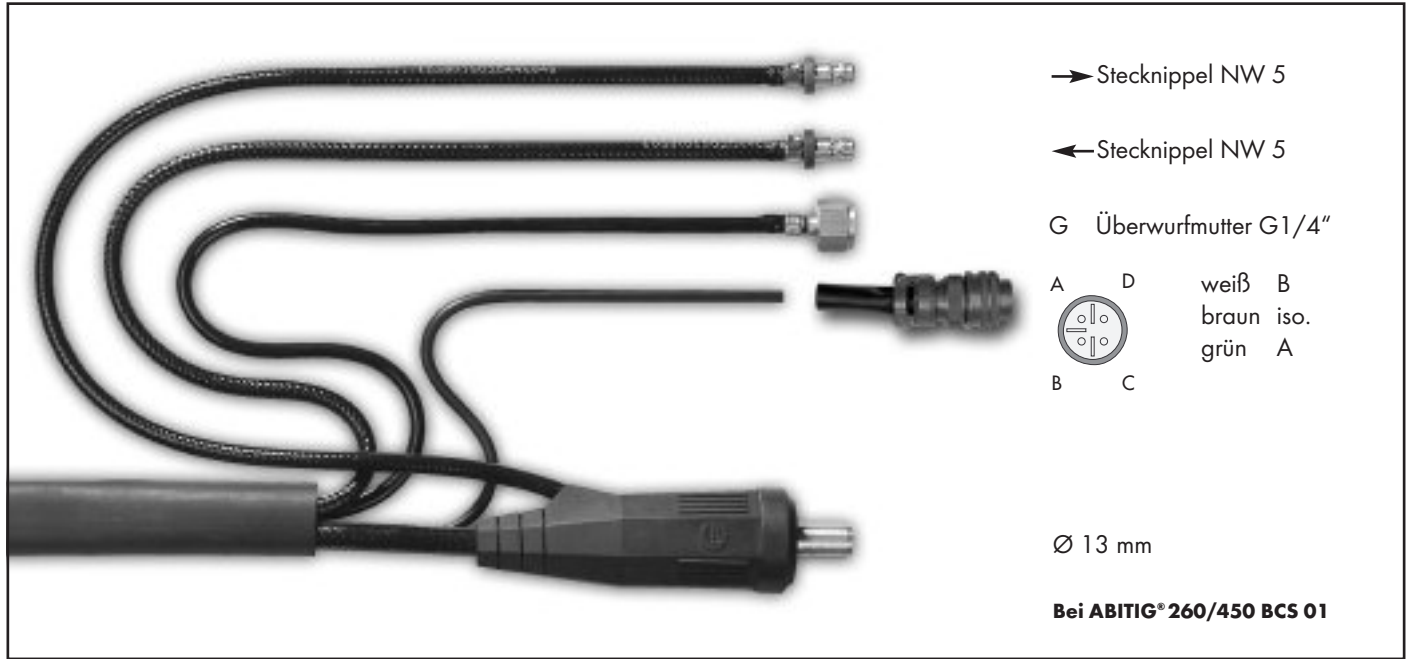

Brennertyp	Länge	Schalterfunktion	maschinenseitiger Anschluss	Schlauchpaketausführung	Bestellnummer
ABITIG® 18	4 m	ED	BSB 35-50 Amphenol 4-pol.	Standard	7S4SK043510010A11
	8 m	ED	BSB 35-50 Amphenol 4-pol.	Standard	7S4SK083510010A11
	4 m	ED	BSB 35-50 Amphenol 4-pol.	High Flex Leder	7S4SH043510010A11
	8 m	ED	BSB 35-50 Amphenol 4-pol.	High Flex Leder	7S4SH083510010A11
ABITIG® 18F	4 m	ED	BSB 35-50 Amphenol 4-pol.	Standard	7S4FK043510010A11
	8 m	ED	BSB 35-50 Amphenol 4-pol.	Standard	7S4FK083510010A11
	4 m	ED	BSB 35-50 Amphenol 4-pol.	High Flex Leder	7S4FH043510010A11
	8 m	ED	BSB 35-50 Amphenol 4-pol.	High Flex Leder	7S4FH083510010A11
ABITIG® 20	4 m	ED	BSB 35-50 Amphenol 4-pol.	Standard	7S5SK043510010A11
	8 m	ED	BSB 35-50 Amphenol 4-pol.	Standard	7S5SK083510010A11
	4 m	ED	BSB 35-50 Amphenol 4-pol.	High Flex Leder	7S5SH043510010A11
	8 m	ED	BSB 35-50 Amphenol 4-pol.	High Flex Leder	7S5SH083510010A11
ABITIG® 20 Little	4 m	ED	BSB 35-50 Amphenol 4-pol.	High Flex Leder	7L5SH043510010A11
	8 m	ED	BSB 35-50 Amphenol 4-pol.	High Flex Leder	7L5SH083510010A11
ABITIG® 20F	4 m	ED	BSB 35-50 Amphenol 4-pol.	Standard	7S5FK043510010A11
	8 m	ED	BSB 35-50 Amphenol 4-pol.	Standard	7S5FK083510010A11
	4 m	ED	BSB 35-50 Amphenol 4-pol.	High Flex Leder	7S5FH043510010A11
	8 m	ED	BSB 35-50 Amphenol 4-pol.	High Flex Leder	7S5FH083510010A11
ABITIG® 20F Little	4 m	ED	BSB 35-50 Amphenol 4-pol.	High Flex Leder	7L5FH043510010A11
	8 m	ED	BSB 35-50 Amphenol 4-pol.	High Flex Leder	7L5FH083510010A11

Technische Änderungen vorbehalten • Verkaufspreise = unverbindliche Preisempfehlung - Angebot freibleibend • © Copyright

ABITIG® GRIP / ABITIG® GRIP Little-Brennerpreisliste

passend für WIG-Stromquellen des Fabrikates „utp“

Brennertyp	Länge	Schalterfunktion	maschinenseitiger Anschluss	Schlauchpaketausführung	Bestellnummer
ABITIG® 12-1	4 m	ED	BSB 35-50 Amphenol 4-pol.	Standard	7S6SK043510010A11
	8 m	ED	BSB 35-50 Amphenol 4-pol.	Standard	7S6SK083510010A11
	4 m	ED	BSB 35-50 Amphenol 4-pol.	High Flex Leder	7S6SH043510010A11
	8 m	ED	BSB 35-50 Amphenol 4-pol.	High Flex Leder	7S6SH083510010A11
ABITIG® 18SC	4 m	ED	BSB 35-50 Amphenol 4-pol.	Standard	7S7SK043510010A11
	8 m	ED	BSB 35-50 Amphenol 4-pol.	Standard	7S7SK083510010A11
	4 m	ED	BSB 35-50 Amphenol 4-pol.	High Flex Leder	7S7SH043510010A11
	8 m	ED	BSB 35-50 Amphenol 4-pol.	High Flex Leder	7S7SH083510010A11
ABITIG® 24W	4 m	ED	BSB 35-50 Amphenol 4-pol.	Standard	7S9SK043510010A11
	8 m	ED	BSB 35-50 Amphenol 4-pol.	Standard	7S9SK083510010A11
	4 m	ED	BSB 35-50 Amphenol 4-pol.	High Flex Leder	7S9SH043510010A11
	8 m	ED	BSB 35-50 Amphenol 4-pol.	High Flex Leder	7S9SH083510010A11
ABITIG® 24W Little	4 m	ED	BSB 35-50 Amphenol 4-pol.	High Flex Leder	7L9SH043510010A11
	8 m	ED	BSB 35-50 Amphenol 4-pol.	High Flex Leder	7L9SH083510010A11
ABITIG® 450W	4 m	ED	BSB 35-50 Amphenol 4-pol.	Standard	7T5SK043510110A11
	8 m	ED	BSB 35-50 Amphenol 4-pol.	Standard	7T5SK083510110A11
	4 m	ED	BSB 35-50 Amphenol 4-pol.	High Flex Leder	7T5SH043510110A11
	8 m	ED	BSB 35-50 Amphenol 4-pol.	High Flex Leder	7T5SH083510110A11
ABITIG® 260W	4 m	ED	BSB 35-50 Amphenol 4-pol.	Standard	7T7SK043510110A11
	8 m	ED	BSB 35-50 Amphenol 4-pol.	Standard	7T7SK083510110A11
	4 m	ED	BSB 35-50 Amphenol 4-pol.	High Flex Leder	7T7SH043510110A11
	8 m	ED	BSB 35-50 Amphenol 4-pol.	High Flex Leder	7T7SH083510110A11
ABITIG® 260W Little	4 m	ED	BSB 35-50 Amphenol 4-pol.	High Flex Leder	7T7SH043510110A11
	8 m	ED	BSB 35-50 Amphenol 4-pol.	High Flex Leder	7T7SH083510110A11
ABITIG® 450W SC	4 m	ED	BSB 35-50 Amphenol 4-pol.	Standard	
	8 m	ED	BSB 35-50 Amphenol 4-pol.	Standard	
	4 m	ED	BSB 35-50 Amphenol 4-pol.	High Flex Leder	7T8SH043510110A11
	8 m	ED	BSB 35-50 Amphenol 4-pol.	High Flex Leder	7T8SH083510110A11

ABITIG® GRIP / ABITIG® GRIP Little-Brennerpreisliste

passend für WIG-Stromquellen des Fabrikates „weco“



Brennertyp	Länge	Schalterfunktion	maschinenseitiger Anschluss	Schlauchpaketausführung	Bestellnummer
ABITIG® 9	4 m	ED	BSB 10-25 Rundsteckverb. 5-pol.	Standard	7S1SK043512235A54
	8 m	ED	BSB 10-25 Rundsteckverb. 5-pol.	Standard	7S1SK083512235A54
	4 m	ED	BSB 10-25 Rundsteckverb. 5-pol.	High Flex Leder	7S1SH043512235A54
	8 m	ED	BSB 10-25 Rundsteckverb. 5-pol.	High Flex Leder	7S1SH083512235A54
ABITIG® 9 Little	4 m	ED	BSB 10-25 Rundsteckverb. 5-pol.	High Flex Leder	7L1SH043512235A54
	8 m	ED	BSB 10-25 Rundsteckverb. 5-pol.	High Flex Leder	7L1SH083512235A54
ABITIG® 9F	4 m	ED	BSB 10-25 Rundsteckverb. 5-pol.	Standard	7S1FK043512235A54
	8 m	ED	BSB 10-25 Rundsteckverb. 5-pol.	Standard	7S1FK083512235A54
	4 m	ED	BSB 10-25 Rundsteckverb. 5-pol.	High Flex Leder	7S1FH043512235A54
	8 m	ED	BSB 10-25 Rundsteckverb. 5-pol.	High Flex Leder	7S1FH083512235A54
ABITIG® 9F Little	4 m	ED	BSB 10-25 Rundsteckverb. 5-pol.	High Flex Leder	7L1FH043512235A54
	8 m	ED	BSB 10-25 Rundsteckverb. 5-pol.	High Flex Leder	7L1FH083512235A54
ABITIG® 17	4 m	ED	BSB 10-25 Rundsteckverb. 5-pol.	Standard	7S2SK043512235A54
	8 m	ED	BSB 10-25 Rundsteckverb. 5-pol.	Standard	7S2SK083512235A54
	4 m	ED	BSB 10-25 Rundsteckverb. 5-pol.	High Flex Leder	7S2SH043512235A54
	8 m	ED	BSB 10-25 Rundsteckverb. 5-pol.	High Flex Leder	7S2SH083512235A54
ABITIG® 17 Little	4 m	ED	BSB 10-25 Rundsteckverb. 5-pol.	High Flex Leder	7L2SH043512235A54
	8 m	ED	BSB 10-25 Rundsteckverb. 5-pol.	High Flex Leder	7L2SH083512235A54
ABITIG® 17F	4 m	ED	BSB 10-25 Rundsteckverb. 5-pol.	Standard	7S2FK043512235A54
	8 m	ED	BSB 10-25 Rundsteckverb. 5-pol.	Standard	7S2FK083512235A54
	4 m	ED	BSB 10-25 Rundsteckverb. 5-pol.	High Flex Leder	7S2FH043512235A54
	8 m	ED	BSB 10-25 Rundsteckverb. 5-pol.	High Flex Leder	7S2FH083512235A54
ABITIG® 17F Little	4 m	ED	BSB 10-25 Rundsteckverb. 5-pol.	High Flex Leder	7L2FH043512235A54
	8 m	ED	BSB 10-25 Rundsteckverb. 5-pol.	High Flex Leder	7L2FH083512235A54

Technische Änderungen vorbehalten • Verkaufspreise = unverbindliche Preisempfehlung - Angebot freibleibend • © Copyright

ABITIG® GRIP / ABITIG® GRIP Little-Brennerpreisliste

passend für WIG-Stromquellen des Fabrikates „weco“

Brennertyp	Länge	Schalterfunktion	maschinenseitiger Anschluss	Schlauchpaketausführung	Bestellnummer
ABITIG® 26	4 m	ED	BSB 10-25 Rundsteckverb. 5-pol.	Standard	7S3SK043512235A54
	8 m	ED	BSB 10-25 Rundsteckverb. 5-pol.	Standard	7S3SK083512235A54
	4 m	ED	BSB 10-25 Rundsteckverb. 5-pol.	High Flex Leder	7S3SH043512235A54
	8 m	ED	BSB 10-25 Rundsteckverb. 5-pol.	High Flex Leder	7S3SH083512235A54
ABITIG® 26F	4 m	ED	BSB 10-25 Rundsteckverb. 5-pol.	Standard	7S3FK043512235A54
	8 m	ED	BSB 10-25 Rundsteckverb. 5-pol.	Standard	7S3FK083512235A54
	4 m	ED	BSB 10-25 Rundsteckverb. 5-pol.	High Flex Leder	7S3FH043512235A54
	8 m	ED	BSB 10-25 Rundsteckverb. 5-pol.	High Flex Leder	7S3FH083512235A54
ABITIG® 24G	4 m	ED	BSB 10-25 Rundsteckverb. 5-pol.	Standard	7S8SK043512235A54
	8 m	ED	BSB 10-25 Rundsteckverb. 5-pol.	Standard	7S8SK083512235A54
	4 m	ED	BSB 10-25 Rundsteckverb. 5-pol.	High Flex Leder	7S8SH043512235A54
	8 m	ED	BSB 10-25 Rundsteckverb. 5-pol.	High Flex Leder	7S8SH083512235A54
ABITIG® 24G Little	4 m	ED	BSB 10-25 Rundsteckverb. 5-pol.	High Flex Leder	7L8SH043512235A54
	8 m	ED	BSB 10-25 Rundsteckverb. 5-pol.	High Flex Leder	7L8SH083512235A54
ABITIG® 200	4 m	ED	BSB 10-25 Rundsteckverb. 5-pol.	Standard	7T4SK043512235A54
	8 m	ED	BSB 10-25 Rundsteckverb. 5-pol.	Standard	7T4SK083512235A54
	4 m	ED	BSB 10-25 Rundsteckverb. 5-pol.	High Flex Leder	7T4SH043512235A54
	8 m	ED	BSB 10-25 Rundsteckverb. 5-pol.	High Flex Leder	7T4SH083512235A54
ABITIG® 200F	4 m	ED	BSB 10-25 Rundsteckverb. 5-pol.	Standard	7T4FK043512235A54
	8 m	ED	BSB 10-25 Rundsteckverb. 5-pol.	Standard	7T4FK083512235A54
	4 m	ED	BSB 10-25 Rundsteckverb. 5-pol.	High Flex Leder	7T4FH043512235A54
	8 m	ED	BSB 10-25 Rundsteckverb. 5-pol.	High Flex Leder	7T4FH083512235A54
ABITIG® 150	4 m	ED	BSB 10-25 Rundsteckverb. 5-pol.	Standard	7T6SK043512235A54
	8 m	ED	BSB 10-25 Rundsteckverb. 5-pol.	Standard	7T6SK083512235A54
	4 m	ED	BSB 10-25 Rundsteckverb. 5-pol.	High Flex Leder	7T6SH043512235A54
	8 m	ED	BSB 10-25 Rundsteckverb. 5-pol.	High Flex Leder	7T6SH083512235A54
ABITIG® 150 Little	4 m	ED	BSB 10-25 Rundsteckverb. 5-pol.	High Flex Leder	7L6SH043512235A54
	8 m	ED	BSB 10-25 Rundsteckverb. 5-pol.	High Flex Leder	7L6SH083512235A54
ABITIG® 150F	4 m	ED	BSB 10-25 Rundsteckverb. 5-pol.	Standard	7T6FK043512235A54
	8 m	ED	BSB 10-25 Rundsteckverb. 5-pol.	Standard	7T6FK083512235A54
	4 m	ED	BSB 10-25 Rundsteckverb. 5-pol.	High Flex Leder	7T6FH043512235A54
	8 m	ED	BSB 10-25 Rundsteckverb. 5-pol.	High Flex Leder	7T6FH083512235A54
ABITIG® 150F Little	4 m	ED	BSB 10-25 Rundsteckverb. 5-pol.	High Flex Leder	7L6FH043512235A54
	8 m	ED	BSB 10-25 Rundsteckverb. 5-pol.	High Flex Leder	7L6FH083512235A54

ABITIG® GRIP / ABITIG® GRIP Little-Brennerpreisliste

passend für WIG-Stromquellen des Fabrikates „weco“

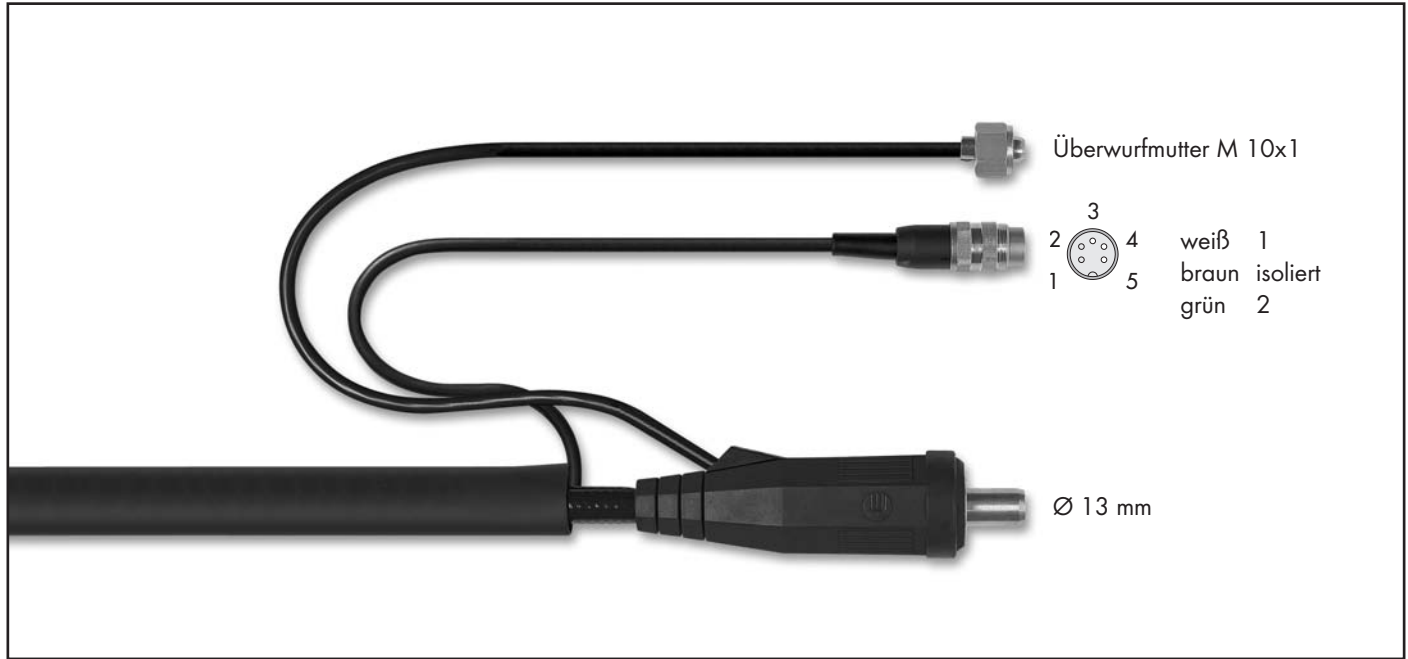

Brennertyp	Länge	Schalterfunktion	maschinenseitiger Anschluss	Schlauchpaketausführung	Bestellnummer
ABITIG® 9	4 m	ED	BSB 35-50 Rundsteckverb. 5-pol.	Standard	7S1SK043510035A54
	8 m	ED	BSB 35-50 Rundsteckverb. 5-pol.	Standard	7S1SK083510035A54
	4 m	ED	BSB 35-50 Rundsteckverb. 5-pol.	High Flex Leder	7S1SH043510035A54
	8 m	ED	BSB 35-50 Rundsteckverb. 5-pol.	High Flex Leder	7S1SH083510035A54
ABITIG® 9 Little	4 m	ED	BSB 35-50 Rundsteckverb. 5-pol.	High Flex Leder	7L1SH043510035A54
	8 m	ED	BSB 35-50 Rundsteckverb. 5-pol.	High Flex Leder	7L1SH083510035A54
ABITIG® 9F	4 m	ED	BSB 35-50 Rundsteckverb. 5-pol.	Standard	7S1FK043510035A54
	8 m	ED	BSB 35-50 Rundsteckverb. 5-pol.	Standard	7S1FK083510035A54
	4 m	ED	BSB 35-50 Rundsteckverb. 5-pol.	High Flex Leder	7S1FH043510035A54
	8 m	ED	BSB 35-50 Rundsteckverb. 5-pol.	High Flex Leder	7S1FH083510035A54
ABITIG® 9F Little	4 m	ED	BSB 35-50 Rundsteckverb. 5-pol.	High Flex Leder	7L1FH043510035A54
	8 m	ED	BSB 35-50 Rundsteckverb. 5-pol.	High Flex Leder	7L1FH083510035A54
ABITIG® 17	4 m	ED	BSB 35-50 Rundsteckverb. 5-pol.	Standard	7S2SK043510035A54
	8 m	ED	BSB 35-50 Rundsteckverb. 5-pol.	Standard	7S2SK083510035A54
	4 m	ED	BSB 35-50 Rundsteckverb. 5-pol.	High Flex Leder	7S2SH043510035A54
	8 m	ED	BSB 35-50 Rundsteckverb. 5-pol.	High Flex Leder	7S2SH083510035A54
ABITIG® 17 Little	4 m	ED	BSB 35-50 Rundsteckverb. 5-pol.	High Flex Leder	7L2SH043510035A54
	8 m	ED	BSB 35-50 Rundsteckverb. 5-pol.	High Flex Leder	7L2SH083510035A54
ABITIG® 17F	4 m	ED	BSB 35-50 Rundsteckverb. 5-pol.	Standard	7S2FK043510035A54
	8 m	ED	BSB 35-50 Rundsteckverb. 5-pol.	Standard	7S2FK083510035A54
	4 m	ED	BSB 35-50 Rundsteckverb. 5-pol.	High Flex Leder	7S2FH043510035A54
	8 m	ED	BSB 35-50 Rundsteckverb. 5-pol.	High Flex Leder	7S2FH083510035A54
ABITIG® 17F Little	4 m	ED	BSB 35-50 Rundsteckverb. 5-pol.	High Flex Leder	7L2FH043510035A54
	8 m	ED	BSB 35-50 Rundsteckverb. 5-pol.	High Flex Leder	7L2FH083510035A54

Technische Änderungen vorbehalten • Verkaufspreise = unverbindliche Preisempfehlung - Angebot freibleibend • © Copyright

ABITIG® GRIP / ABITIG® GRIP Little-Brennerpreisliste

passend für WIG-Stromquellen des Fabrikates „weco“

Brennertyp	Länge	Schalterfunktion	maschinenseitiger Anschluss	Schlauchpaket-ausführung	Bestellnummer
ABITIG® 26	4 m	ED	BSB 35-50 Rundsteckverb. 5-pol.	Standard	7S3SK043510035A54
	8 m	ED	BSB 35-50 Rundsteckverb. 5-pol.	Standard	7S3SK083510035A54
	4 m	ED	BSB 35-50 Rundsteckverb. 5-pol.	High Flex Leder	7S3SH043510035A54
	8 m	ED	BSB 35-50 Rundsteckverb. 5-pol.	High Flex Leder	7S3SH083510035A54
ABITIG® 26F	4 m	ED	BSB 35-50 Rundsteckverb. 5-pol.	Standard	7S3FK043510035A54
	8 m	ED	BSB 35-50 Rundsteckverb. 5-pol.	Standard	7S3FK083510035A54
	4 m	ED	BSB 35-50 Rundsteckverb. 5-pol.	High Flex Leder	7S3FH043510035A54
	8 m	ED	BSB 35-50 Rundsteckverb. 5-pol.	High Flex Leder	7S3FH083510035A54
ABITIG® 24G	4 m	ED	BSB 35-50 Rundsteckverb. 5-pol.	Standard	7S8SK043510035A54
	8 m	ED	BSB 35-50 Rundsteckverb. 5-pol.	Standard	7S8SK083510035A54
	4 m	ED	BSB 35-50 Rundsteckverb. 5-pol.	High Flex Leder	7S8SH043510035A54
	8 m	ED	BSB 35-50 Rundsteckverb. 5-pol.	High Flex Leder	7S8SH083510035A54
ABITIG® 24G	4 m	ED	BSB 35-50 Rundsteckverb. 5-pol.	High Flex Leder	7L8SH043510035A54
	8 m	ED	BSB 35-50 Rundsteckverb. 5-pol.	High Flex Leder	7L8SH083510035A54
ABITIG® 200	4 m	ED	BSB 35-50 Rundsteckverb. 5-pol.	Standard	7T4SK043510035A54
	8 m	ED	BSB 35-50 Rundsteckverb. 5-pol.	Standard	7T4SK083510035A54
	4 m	ED	BSB 35-50 Rundsteckverb. 5-pol.	High Flex Leder	7T4SH043510035A54
	8 m	ED	BSB 35-50 Rundsteckverb. 5-pol.	High Flex Leder	7T4SH083510035A54
ABITIG® 200F	4 m	ED	BSB 35-50 Rundsteckverb. 5-pol.	Standard	7T4FK043510035A54
	8 m	ED	BSB 35-50 Rundsteckverb. 5-pol.	Standard	7T4FK083510035A54
	4 m	ED	BSB 35-50 Rundsteckverb. 5-pol.	High Flex Leder	7T4FH043510035A54
	8 m	ED	BSB 35-50 Rundsteckverb. 5-pol.	High Flex Leder	7T4FH083510035A54
ABITIG® 150	4 m	ED	BSB 35-50 Rundsteckverb. 5-pol.	Standard	7T6SK043510035A54
	8 m	ED	BSB 35-50 Rundsteckverb. 5-pol.	Standard	7T6SK083510035A54
	4 m	ED	BSB 35-50 Rundsteckverb. 5-pol.	High Flex Leder	7T6SH043510035A54
	8 m	ED	BSB 35-50 Rundsteckverb. 5-pol.	High Flex Leder	7T6SH083510035A54
ABITIG® 150 Little	4 m	ED	BSB 35-50 Rundsteckverb. 5-pol.	High Flex Leder	7L6SH043510035A54
	8 m	ED	BSB 35-50 Rundsteckverb. 5-pol.	High Flex Leder	7L6SH083510035A54
ABITIG® 150F	4 m	ED	BSB 35-50 Rundsteckverb. 5-pol.	Standard	7T6FK043510035A54
	8 m	ED	BSB 35-50 Rundsteckverb. 5-pol.	Standard	7T6FK083510035A54
	4 m	ED	BSB 35-50 Rundsteckverb. 5-pol.	High Flex Leder	7T6FH043510035A54
	8 m	ED	BSB 35-50 Rundsteckverb. 5-pol.	High Flex Leder	7T6FH083510035A54
ABITIG® 150F Little	4 m	ED	BSB 35-50 Rundsteckverb. 5-pol.	High Flex Leder	7L6FH043510035A54
	8 m	ED	BSB 35-50 Rundsteckverb. 5-pol.	High Flex Leder	7L6FH083510035A54

ABITIG® GRIP / ABITIG® GRIP Little-Brennerpreisliste

passend für WIG-Stromquellen des Fabrikates „weltec“

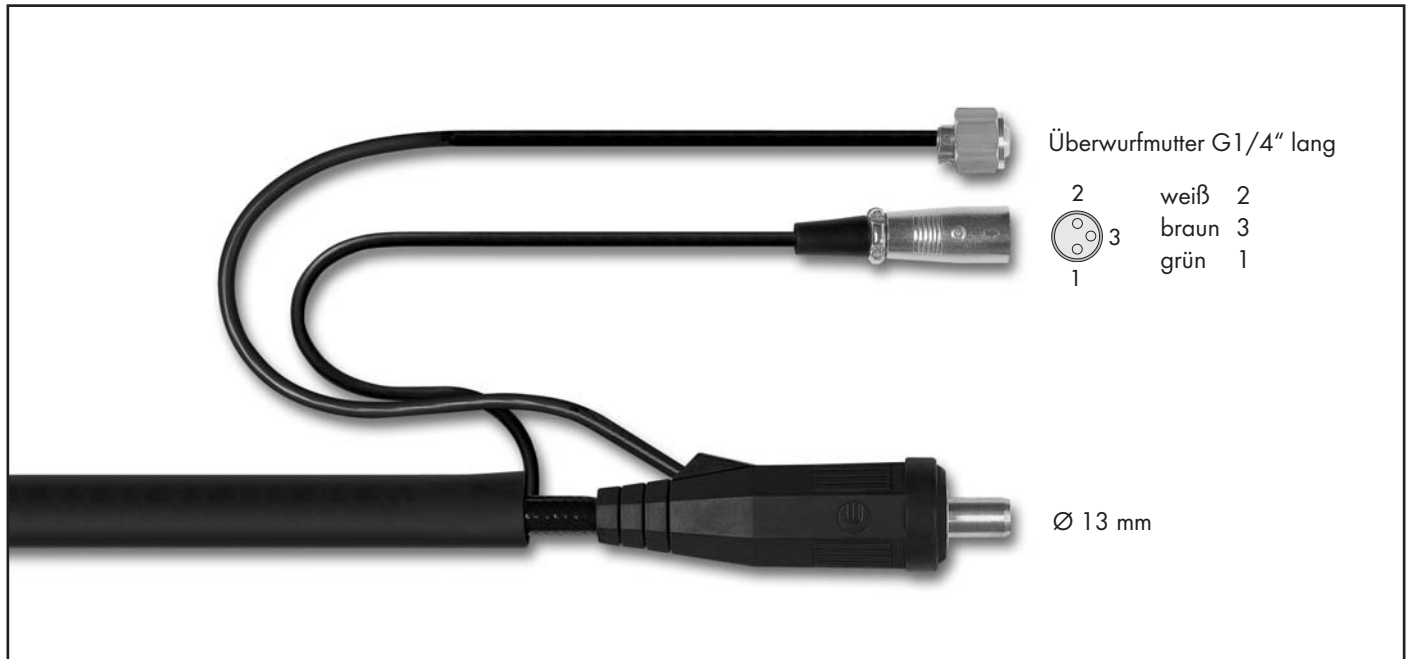

Brennertyp	Länge	Schalterfunktion	maschinenseitiger Anschluss	Schlauchpaketausführung	Bestellnummer
ABITIG® 9	4 m	DD	BSB 35-50 Rundsteckverb. 3-pol.	Standard	7S1SK043520041A51
	8 m	DD	BSB 35-50 Rundsteckverb. 3-pol.	Standard	7S1SK083520041A51
	4 m	DD	BSB 35-50 Rundsteckverb. 3-pol.	High Flex Leder	7S1SH043520041A51
	8 m	DD	BSB 35-50 Rundsteckverb. 3-pol.	High Flex Leder	7S1SH083520041A51
ABITIG® 9 Little	4 m	DD	BSB 35-50 Rundsteckverb. 3-pol.	High Flex Leder	7L1SH043520041A51
	8 m	DD	BSB 35-50 Rundsteckverb. 3-pol.	High Flex Leder	7L1SH083520041A51
ABITIG® 9F	4 m	DD	BSB 35-50 Rundsteckverb. 3-pol.	Standard	7S1FK043520041A51
	8 m	DD	BSB 35-50 Rundsteckverb. 3-pol.	Standard	7S1FK083520041A01
	4 m	DD	BSB 35-50 Rundsteckverb. 3-pol.	High Flex Leder	7S1FH043520041A51
	8 m	DD	BSB 35-50 Rundsteckverb. 3-pol.	High Flex Leder	7S1FH083520041A51
ABITIG® 9F Little	4 m	DD	BSB 35-50 Rundsteckverb. 3-pol.	High Flex Leder	7L1FH043520041A51
	8 m	DD	BSB 35-50 Rundsteckverb. 3-pol.	High Flex Leder	7L1FH083520041A51
ABITIG® 17	4 m	DD	BSB 35-50 Rundsteckverb. 3-pol.	Standard	7S2SK043520041A51
	8 m	DD	BSB 35-50 Rundsteckverb. 3-pol.	Standard	7S2SK083520041A51
	4 m	DD	BSB 35-50 Rundsteckverb. 3-pol.	High Flex Leder	7S2SH043520041A51
	8 m	DD	BSB 35-50 Rundsteckverb. 3-pol.	High Flex Leder	7S2SH083520041A51
ABITIG® 17 Little	4 m	DD	BSB 35-50 Rundsteckverb. 3-pol.	High Flex Leder	7L2SH043520041A51
	8 m	DD	BSB 35-50 Rundsteckverb. 3-pol.	High Flex Leder	7L2SH083520041A51
ABITIG® 17F	4 m	DD	BSB 35-50 Rundsteckverb. 3-pol.	Standard	7S2FK043520041A51
	8 m	DD	BSB 35-50 Rundsteckverb. 3-pol.	Standard	7S2FK083520041A51
	4 m	DD	BSB 35-50 Rundsteckverb. 3-pol.	High Flex Leder	7S2FH043520041A51
	8 m	DD	BSB 35-50 Rundsteckverb. 3-pol.	High Flex Leder	7S2FH083520041A51
ABITIG® 17F Little	4 m	DD	BSB 35-50 Rundsteckverb. 3-pol.	High Flex Leder	7L2FH043520041A51
	8 m	DD	BSB 35-50 Rundsteckverb. 3-pol.	High Flex Leder	7L2FH083520041A51

Technische Änderungen vorbehalten • Verkaufspreise = unverbindliche Preisempfehlung - Angebot freibleibend • © Copyright

ABITIG® GRIP / ABITIG® GRIP Little-Brennerpreisliste

passend für WIG-Stromquellen des Fabrikates „weltec“

Brennertyp	Länge	Schalterfunktion	maschinenseitiger Anschluss	Schlauchpaketausführung	Bestellnummer
ABITIG® 26	4 m	DD	BSB 35-50 Rundsteckverb. 3-pol.	Standard	7S3SK043520041A51
	8 m	DD	BSB 35-50 Rundsteckverb. 3-pol.	Standard	7S3SK083520041A51
	4 m	DD	BSB 35-50 Rundsteckverb. 3-pol.	High Flex Leder	7S3SH043520041A51
	8 m	DD	BSB 35-50 Rundsteckverb. 3-pol.	High Flex Leder	7S3SH083520041A51
ABITIG® 26F	4 m	DD	BSB 35-50 Rundsteckverb. 3-pol.	Standard	7S3FK043520041A51
	8 m	DD	BSB 35-50 Rundsteckverb. 3-pol.	Standard	7S3FK083520041A51
	4 m	DD	BSB 35-50 Rundsteckverb. 3-pol.	High Flex Leder	7S3FH043520041A51
	8 m	DD	BSB 35-50 Rundsteckverb. 3-pol.	High Flex Leder	7S3FH083520041A51
ABITIG® 24G	4 m	DD	BSB 35-50 Rundsteckverb. 3-pol.	Standard	7S8SK043520041A51
	8 m	DD	BSB 35-50 Rundsteckverb. 3-pol.	Standard	7S8SK083520041A51
	4 m	DD	BSB 35-50 Rundsteckverb. 3-pol.	High Flex Leder	7S8SH043520041A51
	8 m	DD	BSB 35-50 Rundsteckverb. 3-pol.	High Flex Leder	7S8SH083520041A51
ABITIG® 24G Little	4 m	DD	BSB 35-50 Rundsteckverb. 3-pol.	High Flex Leder	7L8SH043520041A51
	8 m	DD	BSB 35-50 Rundsteckverb. 3-pol.	High Flex Leder	7L8SH083520041A51
ABITIG® 200	4 m	DD	BSB 35-50 Rundsteckverb. 3-pol.	Standard	7T4SK043520041A51
	8 m	DD	BSB 35-50 Rundsteckverb. 3-pol.	Standard	7T4SK083520041A51
	4 m	DD	BSB 35-50 Rundsteckverb. 3-pol.	High Flex Leder	7T4SH043520041A51
	8 m	DD	BSB 35-50 Rundsteckverb. 3-pol.	High Flex Leder	7T4SH083520041A51
ABITIG® 200F	4 m	DD	BSB 35-50 Rundsteckverb. 3-pol.	Standard	7T4FK043520041A51
	8 m	DD	BSB 35-50 Rundsteckverb. 3-pol.	Standard	7T4FK083520041A51
	4 m	DD	BSB 35-50 Rundsteckverb. 3-pol.	High Flex Leder	7T4FH043520041A51
	8 m	DD	BSB 35-50 Rundsteckverb. 3-pol.	High Flex Leder	7T4FH083520041A51
ABITIG® 150	4 m	DD	BSB 35-50 Rundsteckverb. 3-pol.	Standard	7T6SK043520041A51
	8 m	DD	BSB 35-50 Rundsteckverb. 3-pol.	Standard	7T6SK083520041A51
	4 m	DD	BSB 35-50 Rundsteckverb. 3-pol.	High Flex Leder	7T6SH043520041A51
	8 m	DD	BSB 35-50 Rundsteckverb. 3-pol.	High Flex Leder	7T6SH083520041A51
ABITIG® 150 Little	4 m	DD	BSB 35-50 Rundsteckverb. 3-pol.	High Flex Leder	7L6SH043520041A51
	8 m	DD	BSB 35-50 Rundsteckverb. 3-pol.	High Flex Leder	7L6SH083520041A51
ABITIG® 150F	4 m	DD	BSB 35-50 Rundsteckverb. 3-pol.	Standard	7T6FK043520041A51
	8 m	DD	BSB 35-50 Rundsteckverb. 3-pol.	Standard	7T6FK083520041A51
	4 m	DD	BSB 35-50 Rundsteckverb. 3-pol.	High Flex Leder	7T6FH043520041A51
	8 m	DD	BSB 35-50 Rundsteckverb. 3-pol.	High Flex Leder	7T6FH083520041A51
ABITIG® 150F Little	4 m	DD	BSB 35-50 Rundsteckverb. 3-pol.	High Flex Leder	7L6FH043520041A51
	8 m	DD	BSB 35-50 Rundsteckverb. 3-pol.	High Flex Leder	7L6FH083520041A51

ABITIG® GRIP / ABITIG® GRIP Little-Brennerpreisliste

passend für WIG-Stromquellen des Fabrikates „weltec“

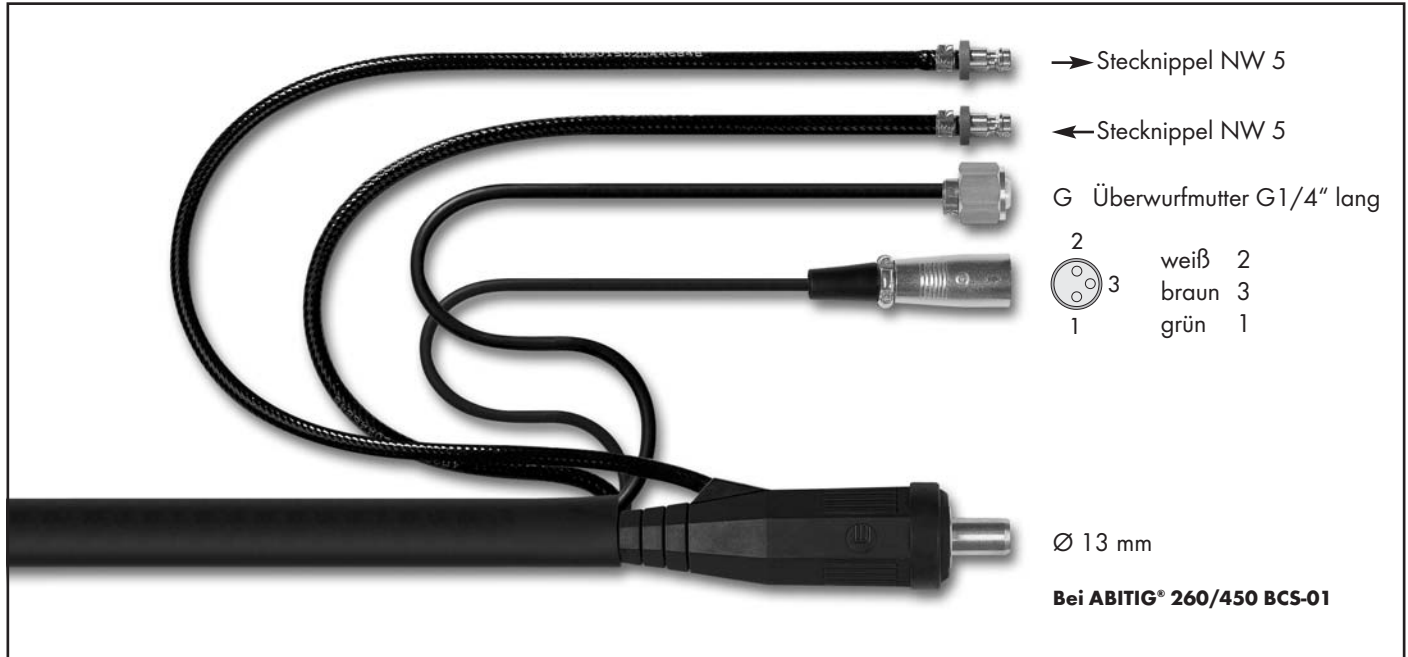

Brennertyp	Länge	Schalterfunktion	maschinenseitiger Anschluss	Schlauchpaketausführung	Bestellnummer
ABITIG® 18	4 m	DD	BSB 35-50 Rundsteckverb. 3-pol.	Standard	7S4SK043520041A81
	8 m	DD	BSB 35-50 Rundsteckverb. 3-pol.	Standard	7S4SK083520041A81
	4 m	DD	BSB 35-50 Rundsteckverb. 3-pol.	High Flex Leder	7S4SH043520041A81
	8 m	DD	BSB 35-50 Rundsteckverb. 3-pol.	High Flex Leder	7S4SH083520041A81
ABITIG® 18F	4 m	DD	BSB 35-50 Rundsteckverb. 3-pol.	Standard	7S4FK043520041A81
	8 m	DD	BSB 35-50 Rundsteckverb. 3-pol.	Standard	7S4FK083520041A81
	4 m	DD	BSB 35-50 Rundsteckverb. 3-pol.	High Flex Leder	7S4FH043520041A81
	8 m	DD	BSB 35-50 Rundsteckverb. 3-pol.	High Flex Leder	7S4FH083520041A81
ABITIG® 20	4 m	DD	BSB 35-50 Rundsteckverb. 3-pol.	Standard	7S5SK043520041A81
	8 m	DD	BSB 35-50 Rundsteckverb. 3-pol.	Standard	7S5SK083520041A81
	4 m	DD	BSB 35-50 Rundsteckverb. 3-pol.	High Flex Leder	7S5SH043520041A81
	8 m	DD	BSB 35-50 Rundsteckverb. 3-pol.	High Flex Leder	7S5SH083520041A81
ABITIG® 20 Little	4 m	DD	BSB 35-50 Rundsteckverb. 3-pol.	High Flex Leder	7L5SH043520041A81
	8 m	DD	BSB 35-50 Rundsteckverb. 3-pol.	High Flex Leder	7L5SH083520041A81
ABITIG® 20F	4 m	DD	BSB 35-50 Rundsteckverb. 3-pol.	Standard	7S5FK043520041A81
	8 m	DD	BSB 35-50 Rundsteckverb. 3-pol.	Standard	7S5FK083520041A81
	4 m	DD	BSB 35-50 Rundsteckverb. 3-pol.	High Flex Leder	7S5FH043520041A81
	8 m	DD	BSB 35-50 Rundsteckverb. 3-pol.	High Flex Leder	7S5FH083520041A81
ABITIG® 20F Little	4 m	DD	BSB 35-50 Rundsteckverb. 3-pol.	High Flex Leder	7L5FH043520041A81
	8 m	DD	BSB 35-50 Rundsteckverb. 3-pol.	High Flex Leder	7L5FH083520041A81

Technische Änderungen vorbehalten • Verkaufspreise = unverbindliche Preisempfehlung - Angebot freibleibend • © Copyright

ABITIG® GRIP / ABITIG® GRIP Little-Brennerpreisliste

passend für WIG-Stromquellen des Fabrikates „weltec“

Brennertyp	Länge	Schalterfunktion	maschinenseitiger Anschluss	Schlauchpaketausführung	Bestellnummer
ABITIG® 12-1	4 m	DD	BSB 35-50 Rundsteckverb. 3-pol.	Standard	7S6SK043520041A81
	8 m	DD	BSB 35-50 Rundsteckverb. 3-pol.	Standard	7S6SK083520041A81
	4 m	DD	BSB 35-50 Rundsteckverb. 3-pol.	High Flex Leder	7S6SH043520041A81
	8 m	DD	BSB 35-50 Rundsteckverb. 3-pol.	High Flex Leder	7S6SH083520041A81
ABITIG® 18SC	4 m	DD	BSB 35-50 Rundsteckverb. 3-pol.	Standard	7S7SK043520041A81
	8 m	DD	BSB 35-50 Rundsteckverb. 3-pol.	Standard	7S7SK083520041A81
	4 m	DD	BSB 35-50 Rundsteckverb. 3-pol.	High Flex Leder	7S7SH043520041A81
	8 m	DD	BSB 35-50 Rundsteckverb. 3-pol.	High Flex Leder	7S7SH083520041A81
ABITIG® 24W	4 m	DD	BSB 35-50 Rundsteckverb. 3-pol.	Standard	7S9SK043520041A81
	8 m	DD	BSB 35-50 Rundsteckverb. 3-pol.	Standard	7S9SK083520041A81
	4 m	DD	BSB 35-50 Rundsteckverb. 3-pol.	High Flex Leder	7S9SH043520041A81
	8 m	DD	BSB 35-50 Rundsteckverb. 3-pol.	High Flex Leder	7S9SH083520041A81
ABITIG® 24W Little	4 m	DD	BSB 35-50 Rundsteckverb. 3-pol.	High Flex Leder	7L9SH043520041A81
	8 m	DD	BSB 35-50 Rundsteckverb. 3-pol.	High Flex Leder	7L9SH083520041A81
ABITIG® 450W	4 m	DD	BSB 35-50 Rundsteckverb. 3-pol.	Standard	7T5SK043520141A81
	8 m	DD	BSB 35-50 Rundsteckverb. 3-pol.	Standard	7T5SK083520141A81
	4 m	DD	BSB 35-50 Rundsteckverb. 3-pol.	High Flex Leder	7T5SH043520141A81
	8 m	DD	BSB 35-50 Rundsteckverb. 3-pol.	High Flex Leder	7T5SH083520141A81
ABITIG® 260W	4 m	DD	BSB 35-50 Rundsteckverb. 3-pol.	Standard	7T7SK043520141A81
	8 m	DD	BSB 35-50 Rundsteckverb. 3-pol.	Standard	7T7SK083520141A81
	4 m	DD	BSB 35-50 Rundsteckverb. 3-pol.	High Flex Leder	7T7SH043520141A81
	8 m	DD	BSB 35-50 Rundsteckverb. 3-pol.	High Flex Leder	7T7SH083520141A81
ABITIG® 260W Little	4 m	DD	BSB 35-50 Rundsteckverb. 3-pol.	High Flex Leder	7L7SH043520141A81
	8 m	DD	BSB 35-50 Rundsteckverb. 3-pol.	High Flex Leder	7L7SH083520141A81
ABITIG® 450W SC	4 m	DD	BSB 35-50 Rundsteckverb. 3-pol.	Standard	
	8 m	DD	BSB 35-50 Rundsteckverb. 3-pol.	Standard	
	4 m	DD	BSB 35-50 Rundsteckverb. 3-pol.	High Flex Leder	7T8SH043520141A81
	8 m	DD	BSB 35-50 Rundsteckverb. 3-pol.	High Flex Leder	7T8SH083520141A81

ABITIG® GRIP / ABITIG® GRIP Little-Brennerpreisliste

passend für WIG-Stromquellen des Fabrikates „woltersdorf“



Brennertyp	Länge	Schalterfunktion	maschinenseitiger Anschluss	Schlauchpaketausführung	Bestellnummer
ABITIG® 9	4 m	DD	BSB 35-50 offen	Standard	7S1SK043520000006
	8 m	DD	BSB 35-50 offen	Standard	7S1SK083520000006
	4 m	DD	BSB 35-50 offen	High Flex Leder	7S1SH043520000006
	8 m	DD	BSB 35-50 offen	High Flex Leder	7S1SH083520000006
ABITIG® 9 Little	4 m	DD	BSB 35-50 offen	High Flex Leder	7L1SH043520000006
	8 m	DD	BSB 35-50 offen	High Flex Leder	7L1SH083520000006
ABITIG® 9F	4 m	DD	BSB 35-50 offen	Standard	7S1FK043520000006
	8 m	DD	BSB 35-50 offen	Standard	7S1FK083520000006
	4 m	DD	BSB 35-50 offen	High Flex Leder	7S1FH043520000006
	8 m	DD	BSB 35-50 offen	High Flex Leder	7S1FH083520000006
ABITIG® 9F Little	4 m	DD	BSB 35-50 offen	High Flex Leder	7L1FH043520000006
	8 m	DD	BSB 35-50 offen	High Flex Leder	7L1FH083520000006
ABITIG® 17	4 m	DD	BSB 35-50 offen	Standard	7S2SK043520000006
	8 m	DD	BSB 35-50 offen	Standard	7S2SK083520000006
	4 m	DD	BSB 35-50 offen	High Flex Leder	7S2SH043520000006
	8 m	DD	BSB 35-50 offen	High Flex Leder	7S2SH083520000006
ABITIG® 17 Little	4 m	DD	BSB 35-50 offen	High Flex Leder	7L2SH043520000006
	8 m	DD	BSB 35-50 offen	High Flex Leder	7L2SH083520000006
ABITIG® 17F	4 m	DD	BSB 35-50 offen	Standard	7S2FK043520000006
	8 m	DD	BSB 35-50 offen	Standard	7S2FK083520000006
	4 m	DD	BSB 35-50 offen	High Flex Leder	7S2FH043520000006
	8 m	DD	BSB 35-50 offen	High Flex Leder	7S2FH083520000006
ABITIG® 17F Little	4 m	DD	BSB 35-50 offen	High Flex Leder	7L2FH043520000006
	8 m	DD	BSB 35-50 offen	High Flex Leder	7L2FH083520000006

Technische Änderungen vorbehalten • Verkaufspreise = unverbindliche Preisempfehlung - Angebot freibleibend • © Copyright

ABITIG® GRIP / ABITIG® GRIP Little-Brennerpreisliste

passend für WIG-Stromquellen des Fabrikates „woltersdorf“

Brennertyp	Länge	Schalterfunktion	maschinenseitiger Anschluss	Schlauchpaketausführung	Bestellnummer
ABITIG® 26	4 m	DD	BSB 35-50 offen	Standard	7S3SK043520000006
	8 m	DD	BSB 35-50 offen	Standard	7S3SK083520000006
	4 m	DD	BSB 35-50 offen	High Flex Leder	7S3SH043520000006
	8 m	DD	BSB 35-50 offen	High Flex Leder	7S3SH083520000006
ABITIG® 26F	4 m	DD	BSB 35-50 offen	Standard	7S3FK043520000006
	8 m	DD	BSB 35-50 offen	Standard	7S3FK083520000006
	4 m	DD	BSB 35-50 offen	High Flex Leder	7S3FH043520000006
	8 m	DD	BSB 35-50 offen	High Flex Leder	7S3FH083520000006
ABITIG® 24G	4 m	DD	BSB 35-50 offen	Standard	7S8SK043520000006
	8 m	DD	BSB 35-50 offen	Standard	7S8SK083520000006
	4 m	DD	BSB 35-50 offen	High Flex Leder	7S8SH043520000006
	8 m	DD	BSB 35-50 offen	High Flex Leder	7S8SH083520000006
ABITIG® 24G Little	4 m	DD	BSB 35-50 offen	High Flex Leder	7L8SH043520000006
	8 m	DD	BSB 35-50 offen	High Flex Leder	7L8SH083520000006
ABITIG® 200	4 m	DD	BSB 35-50 offen	Standard	7T4SK043520000006
	8 m	DD	BSB 35-50 offen	Standard	7T4SK083520000006
	4 m	DD	BSB 35-50 offen	High Flex Leder	7T4SH043520000006
	8 m	DD	BSB 35-50 offen	High Flex Leder	7T4SH083520000006
ABITIG® 200F	4 m	DD	BSB 35-50 offen	Standard	7T4FK043520000006
	8 m	DD	BSB 35-50 offen	Standard	7T4FK083520000006
	4 m	DD	BSB 35-50 offen	High Flex Leder	7T4FH043520000006
	8 m	DD	BSB 35-50 offen	High Flex Leder	7T4FH083520000006
ABITIG® 150	4 m	DD	BSB 35-50 offen	Standard	7T6SK043520000006
	8 m	DD	BSB 35-50 offen	Standard	7T6SK083520000006
	4 m	DD	BSB 35-50 offen	High Flex Leder	7T6SH043520000006
	8 m	DD	BSB 35-50 offen	High Flex Leder	7T6SH083520000006
ABITIG® 150 Little	4 m	DD	BSB 35-50 offen	High Flex Leder	7L6SH043520000006
	8 m	DD	BSB 35-50 offen	High Flex Leder	7L6SH083520000006
ABITIG® 150F	4 m	DD	BSB 35-50 offen	Standard	7T6FK043520000006
	8 m	DD	BSB 35-50 offen	Standard	7T6FK083520000006
	4 m	DD	BSB 35-50 offen	High Flex Leder	7T6FH043520000006
	8 m	DD	BSB 35-50 offen	High Flex Leder	7T6FH083520000006
ABITIG® 150F Little	4 m	DD	BSB 35-50 offen	High Flex Leder	7L6FH043520000006
	8 m	DD	BSB 35-50 offen	High Flex Leder	7L6FH083520000006

ABITIG® GRIP / ABITIG® GRIP Little-Brennerpreisliste

passend für WIG-Stromquellen des Fabrikates „woltersdorf“

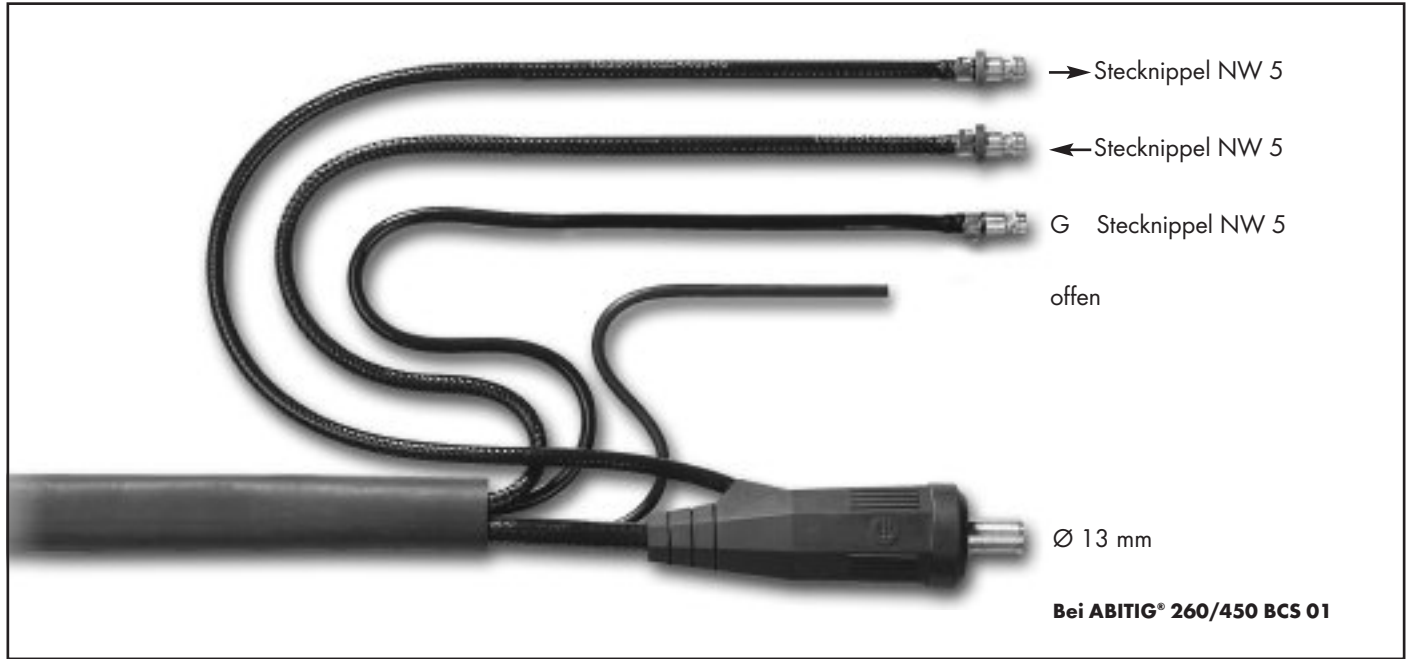

Brennertyp	Länge	Schalterfunktion	maschinenseitiger Anschluss	Schlauchpaketausführung	Bestellnummer
ABITIG® 18	4 m	DD	BSB 35-50 offen	Standard	7S4SK043520000020
	8 m	DD	BSB 35-50 offen	Standard	7S4SK083520000020
	4 m	DD	BSB 35-50 offen	High Flex Leder	7S4SH043520000020
	8 m	DD	BSB 35-50 offen	High Flex Leder	7S4SH083520000020
ABITIG® 18F	4 m	DD	BSB 35-50 offen	Standard	7S4FK043520000020
	8 m	DD	BSB 35-50 offen	Standard	7S4FK083520000020
	4 m	DD	BSB 35-50 offen	High Flex Leder	7S4FH043520000020
	8 m	DD	BSB 35-50 offen	High Flex Leder	7S4FH083520000020
ABITIG® 20	4 m	DD	BSB 35-50 offen	Standard	7S5SK043520000020
	8 m	DD	BSB 35-50 offen	Standard	7S5SK083520000020
	4 m	DD	BSB 35-50 offen	High Flex Leder	7S5SH043520000020
	8 m	DD	BSB 35-50 offen	High Flex Leder	7S5SH083520000020
ABITIG® 20 Little	4 m	DD	BSB 35-50 offen	High Flex Leder	7L5SH043520000020
	8 m	DD	BSB 35-50 offen	High Flex Leder	7L5SH083520000020
ABITIG® 20F	4 m	DD	BSB 35-50 offen	Standard	7S5FK043520000020
	8 m	DD	BSB 35-50 offen	Standard	7S5FK083520000020
	4 m	DD	BSB 35-50 offen	High Flex Leder	7S5FH043520000020
	8 m	DD	BSB 35-50 offen	High Flex Leder	7S5FH083520000020
ABITIG® 20F Little	4 m	DD	BSB 35-50 offen	High Flex Leder	7L5FH043520000020
	8 m	DD	BSB 35-50 offen	High Flex Leder	7L5FH083520000020

Technische Änderungen vorbehalten • Verkaufspreise = unverbindliche Preisempfehlung - Angebot freibleibend • © Copyright

ABITIG® GRIP / ABITIG® GRIP Little-Brennerpreisliste

passend für WIG-Stromquellen des Fabrikates „woltersdorf“

Brennertyp	Länge	Schalterfunktion	maschinenseitiger Anschluss	Schlauchpaketausführung	Bestellnummer
ABITIG® 12-1	4 m	DD	BSB 35-50 offen	Standard	7S6SK043520000020
	8 m	DD	BSB 35-50 offen	Standard	7S6SK083520000020
	4 m	DD	BSB 35-50 offen	High Flex Leder	7S6SH043520000020
	8 m	DD	BSB 35-50 offen	High Flex Leder	7S6SH083520000020
ABITIG® 18SC	4 m	DD	BSB 35-50 offen	Standard	7S7SK043520000020
	8 m	DD	BSB 35-50 offen	Standard	7S7SK083520000020
	4 m	DD	BSB 35-50 offen	High Flex Leder	7S7SH043520000020
	8 m	DD	BSB 35-50 offen	High Flex Leder	7S7SH083520000020
ABITIG® 24W	4 m	DD	BSB 35-50 offen	Standard	7S9SK043520000020
	8 m	DD	BSB 35-50 offen	Standard	7S9SK083520000020
	4 m	DD	BSB 35-50 offen	High Flex Leder	7S9SH043520000020
	8 m	DD	BSB 35-50 offen	High Flex Leder	7S9SH083520000020
ABITIG® 24W Little	4 m	DD	BSB 35-50 offen	High Flex Leder	7L9SH043520000020
	8 m	DD	BSB 35-50 offen	High Flex Leder	7L9SH083520000020
ABITIG® 450W	4 m	DD	BSB 35-50 offen	Standard	7T5SK043520100020
	8 m	DD	BSB 35-50 offen	Standard	7T5SK083520100020
	4 m	DD	BSB 35-50 offen	High Flex Leder	7T5SH043520100020
	8 m	DD	BSB 35-50 offen	High Flex Leder	7T5SH083520100020
ABITIG® 260W	4 m	DD	BSB 35-50 offen	Standard	7T7SK043520100020
	8 m	DD	BSB 35-50 offen	Standard	7T7SK083520100020
	4 m	DD	BSB 35-50 offen	High Flex Leder	7T7SH043520100020
	8 m	DD	BSB 35-50 offen	High Flex Leder	7T7SH083520100020
ABITIG® 260W Little	4 m	DD	BSB 35-50 offen	High Flex Leder	7L7SH043520100020
	8 m	DD	BSB 35-50 offen	High Flex Leder	7L7SH083520100020
ABITIG® 450W SC	4 m	DD	BSB 35-50 offen	Standard	
	8 m	DD	BSB 35-50 offen	Standard	
	4 m	DD	BSB 35-50 offen	High Flex Leder	7T8SH043520100020
	8 m	DD	BSB 35-50 offen	High Flex Leder	7T8SH083520100020

ABITIG®-Brennerpreisliste für MT Brenner (Automatenbrenner)

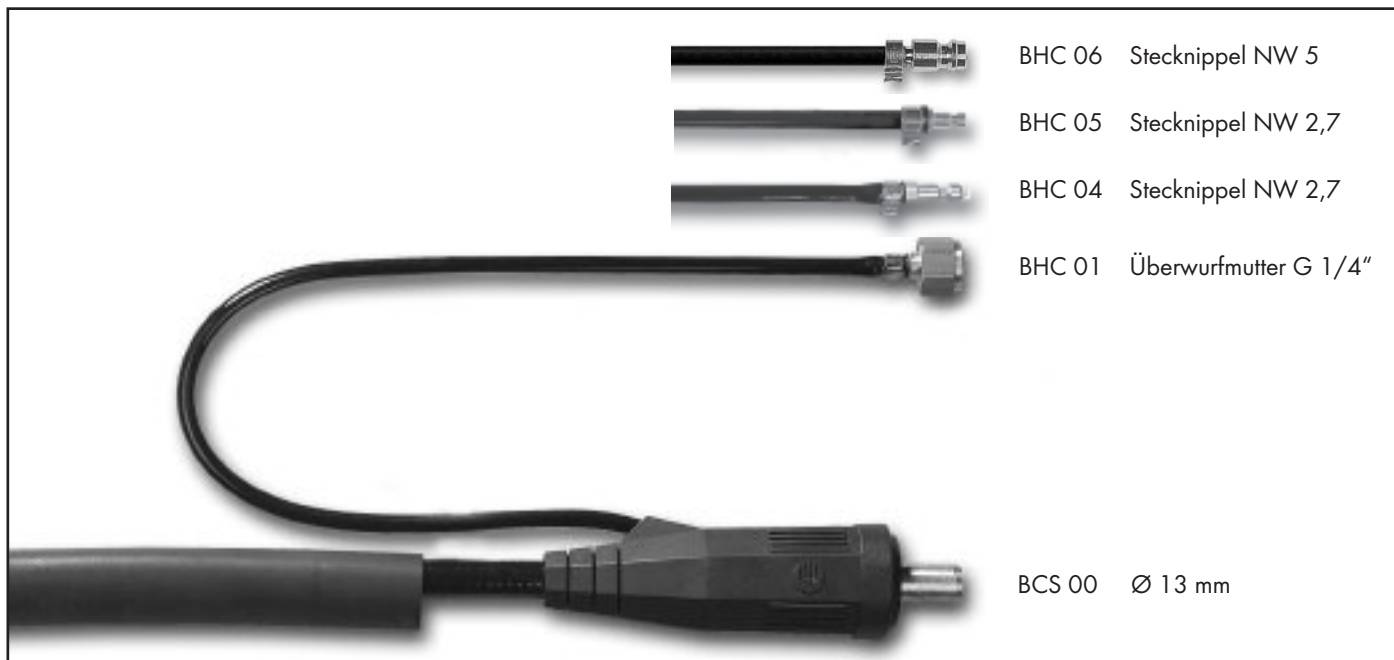

BHC 06 Stecknippel NW 5

BHC 05 Stecknippel NW 2,7

BHC 04 Stecknippel NW 2,7

BHC 01 Überwurfmutter G 1/4"

BCS 00 Ø 13 mm

Brennertyp	Länge	maschinenseitiger Anschluss	Bestellnummer
ABITIG® 150 MT	4 m	BSB 3550 / G 1/4"	7M410400- -00- - -01
	8 m	BSB 3550 / G 1/4"	7M410800- -00- - -01
ABITIG® 200 MT*	4 m	BSB 3550 / G 1/4"	7M4V0400- -00- - -01
	8 m	BSB 3550 / G 1/4"	7M4V0800- -00- - -01
ABITIG® 150 MT	4 m	BSB 3550 / NW 2,7 Migatronik	7M410400- -00- - -04
	8 m	BSB 3550 / NW 2,7 Migatronik	7M410800- -00- - -04
ABITIG® 200 MT*	4 m	BSB 3550 / NW 2,7 Migatronik	7M4V0400- -00- - -04
	8 m	BSB 3550 / NW 2,7 Migatronik	7M4V0800- -00- - -04
ABITIG® 150 MT	4 m	BSB 3550 / NW 2,7	7M410400- -00- - -05
	8 m	BSB 3550 / NW 2,7	7M410800- -00- - -05
ABITIG® 200 MT*	4 m	BSB 3550 / NW 2,7	7M4V0400- -00- - -05
	8 m	BSB 3550 / NW 2,7	7M4V0800- -00- - -05
ABITIG® 150 MT	4 m	BSB 3550 / NW 5	7M410400- -00- - -06
	8 m	BSB 3550 / NW 5	7M410800- -00- - -06
ABITIG® 200 MT*	4 m	BSB 3550 / NW 5	7M4V0400- -00- - -06
	8 m	BSB 3550 / NW 5	7M4V0800- -00- - -06

Technische Änderungen vorbehalten • Verkaufspreise = unverbindliche Preisempfehlung - Angebot freibleibend • © Copyright

* ABITIG 200 MT mit voreinstellbarer Elektrode

ABITIG®-Brennerpreisliste für MT Brenner (Automatenbrenner)



Brennertyp	Länge	maschinenseitiger Anschluss	Bestellnummer
ABITIG® 150 MT	4 m	ZA - GZ	7M410400- -03- - -00
	8 m	ZA - GZ	7M410800- -03- - -00
ABITIG® 200 MT*	4 m	ZA - GZ	7M4V0400- -03- - -00
	8 m	ZA - GZ	7M4V0800- -03- - -00

ABITIG®-Brennerpreisliste für MT Brenner (Automatenbrenner)



Brennertyp	Länge	maschinenseitiger Anschluss	Bestellnummer
ABITIG® 150 MT	4 m	ZA WTG 5	7M410400- -04- - -00
	8 m	ZA WTG 5	7M410800- -04- - -00
ABITIG® 200 MT*	4 m	ZA WTG 5	7M4V0400- -04- - -00
	8 m	ZA WTG 5	7M4V0800- -04- - -00

Technische Änderungen vorbehalten • Verkaufspreise = unverbindliche Preisempfehlung – Angebot freibleibend • © Copyright
* ABITIG 200 MT mit voreinstellbarer Elektrode

ABITIG®-Brennerpreisliste für MT Brenner (Automatenbrenner)



Brennertyp	Länge	maschinenseitiger Anschluss	Bestellnummer
ABITIG® 150 MT	4 m	G 3/8" Üwm.	7M410400- -06- - -00
	8 m	G 3/8" Üwm.	7M410800- -06- - -00
ABITIG® 200 MT*	4 m	G 3/8" Üwm.	7M4V0400- -06- - -00
	8 m	G 3/8" Üwm.	7M4V0800- -06- - -00

ABITIG®-Brennerpreisliste für MT Brenner (Automatenbrenner)



Brennertyp	Länge	maschinenseitiger Anschluss	Bestellnummer
ABITIG® 150 MT	4 m	ZA 9-polig	7M410400- -07- - -00
	8 m	ZA 9-polig	7M410800- -07- - -00
ABITIG® 200 MT*	4 m	ZA 9-polig	7M4V0400- -07- - -00
	8 m	ZA 9-polig	7M4V0800- -07- - -00

Technische Änderungen vorbehalten • Verkaufspreise = unverbindliche Preisempfehlung – Angebot freibleibend • © Copyright
* ABITIG 200 MT mit voreinstellbarer Elektrode

ABITIG®-Brennerpreisliste für MT Brenner (Automatenbrenner)

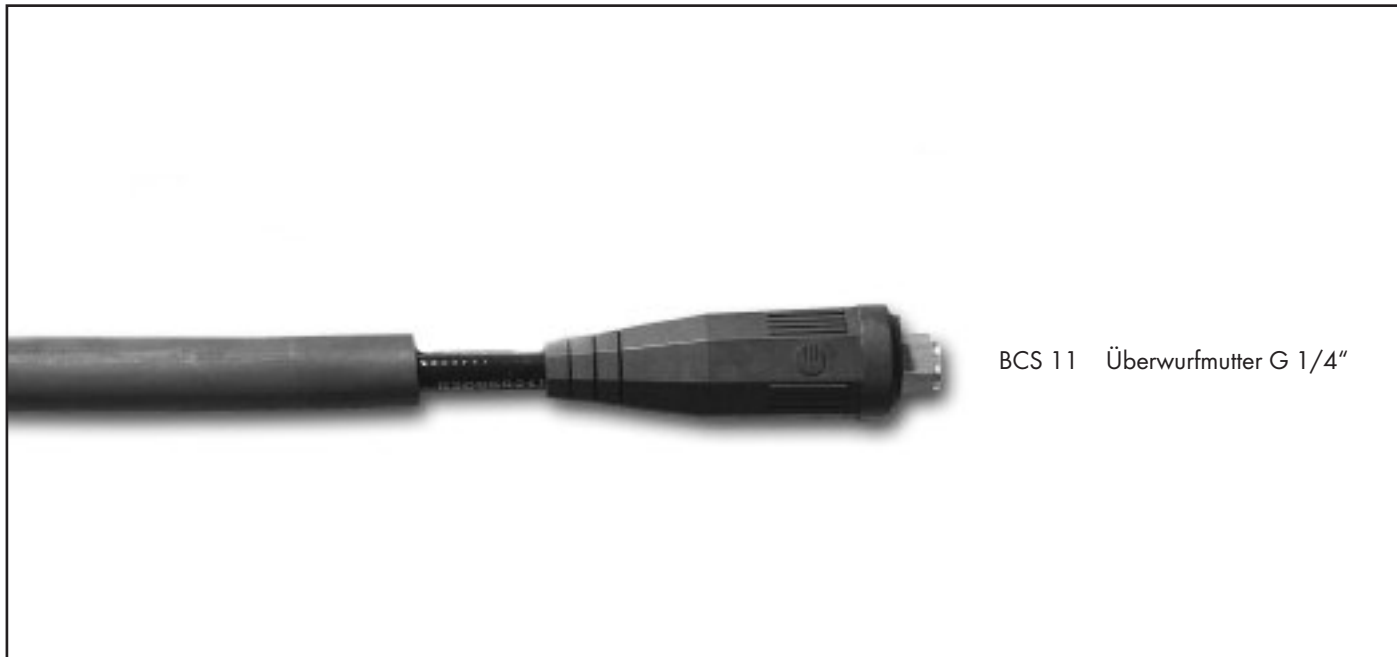

BCS 11 Überwurfmutter G 1/4"

Brennertyp	Länge	maschinenseitiger Anschluss	Bestellnummer
ABITIG® 150 MT	4 m	G 1/4" Üwm.	7M410400- -11- - -00
	8 m	G 1/4" Üwm.	7M410800- -11- - -00
ABITIG® 200 MT*	4 m	G 1/4" Üwm.	7M4V0400- -11- - -00
	8 m	G 1/4" Üwm.	7M4V0800- -11- - -00

ABITIG®-Brennerpreisliste für MT Brenner (Automatenbrenner)



BCS 18 oerlikon

Brennertyp	Länge	maschinenseitiger Anschluss	Bestellnummer
ABITIG® 150 MT	4 m	oerlikon ZA	7M410400- -18- - -00
	8 m	oerlikon ZA	7M410800- -18- - -00
ABITIG® 200 MT*	4 m	oerlikon ZA	7M4V0400- -18- - -00
	8 m	oerlikon ZA	7M4V0800- -18- - -00

Technische Änderungen vorbehalten • Verkaufspreise = unverbindliche Preisempfehlung – Angebot freibleibend • © Copyright
* ABITIG 200 MT mit voreinstellbarer Elektrode

ABITIG®-Brennerpreisliste für MT Brenner (Automatenbrenner)



Brennertyp	Länge	maschinenseitiger Anschluss	Bestellnummer
ABITIG® 150 MT	4 m	CG Anschluss dalex	7M410400- -20- - -00
	8 m	CG Anschluss dalex	7M410800- -20- - -00
ABITIG® 200 MT*	4 m	CG Anschluss dalex	7M4V0400- -20- - -00
	8 m	CG Anschluss dalex	7M4V0800- -20- - -00

ABITIG®-Brennerpreisliste für MT Brenner (Automatenbrenner)

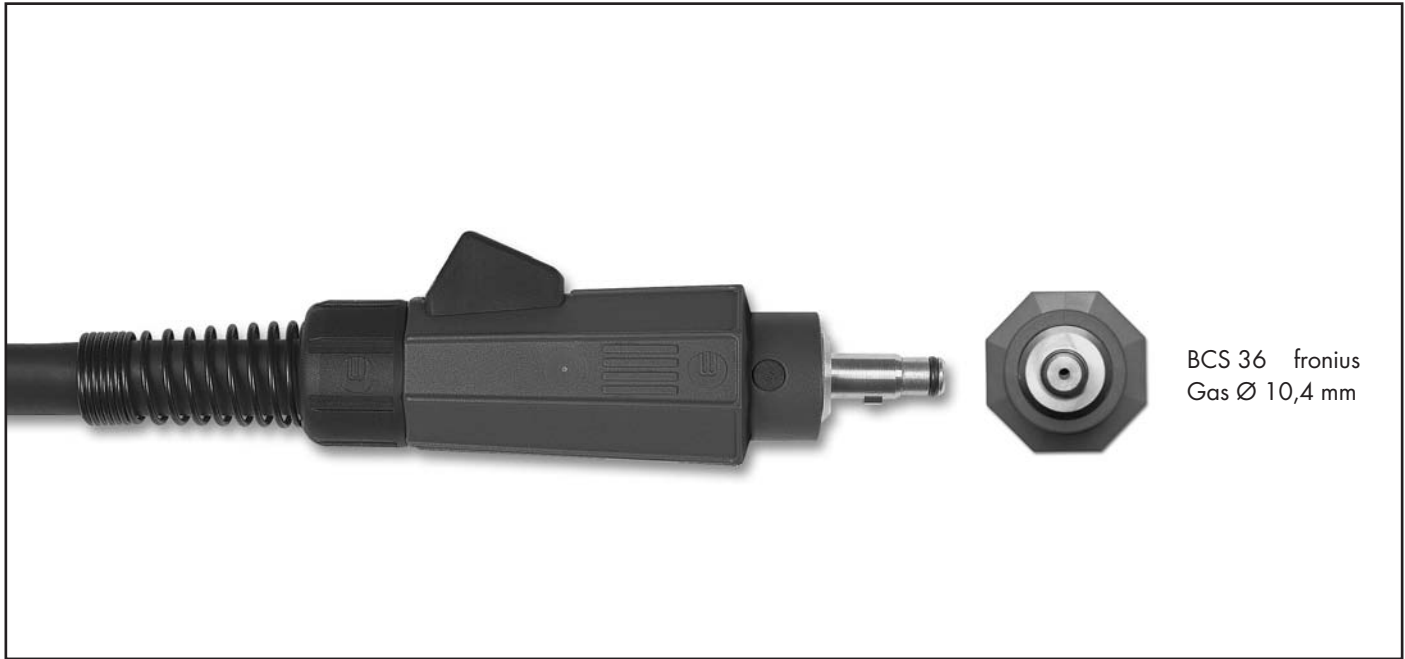

Brennertyp	Länge	maschinenseitiger Anschluss	Bestellnummer
ABITIG® 150 MT	4 m	TTG Anschluss Fronius	7M410400- -36- - -00
	8 m	TTG Anschluss Fronius	7M410800- -36- - -00
ABITIG® 200 MT*	4 m	TTG Anschluss Fronius	7M4V0400- -36- - -00
	8 m	TTG Anschluss Fronius	7M4V0800- -36- - -00

Technische Änderungen vorbehalten • Verkaufspreise = unverbindliche Preisempfehlung - Angebot freibleibend • © Copyright
* ABITIG 200 MT mit voreinstellbarer Elektrode

ABITIG®-Brennerpreisliste für MT Brenner (Automatenbrenner)

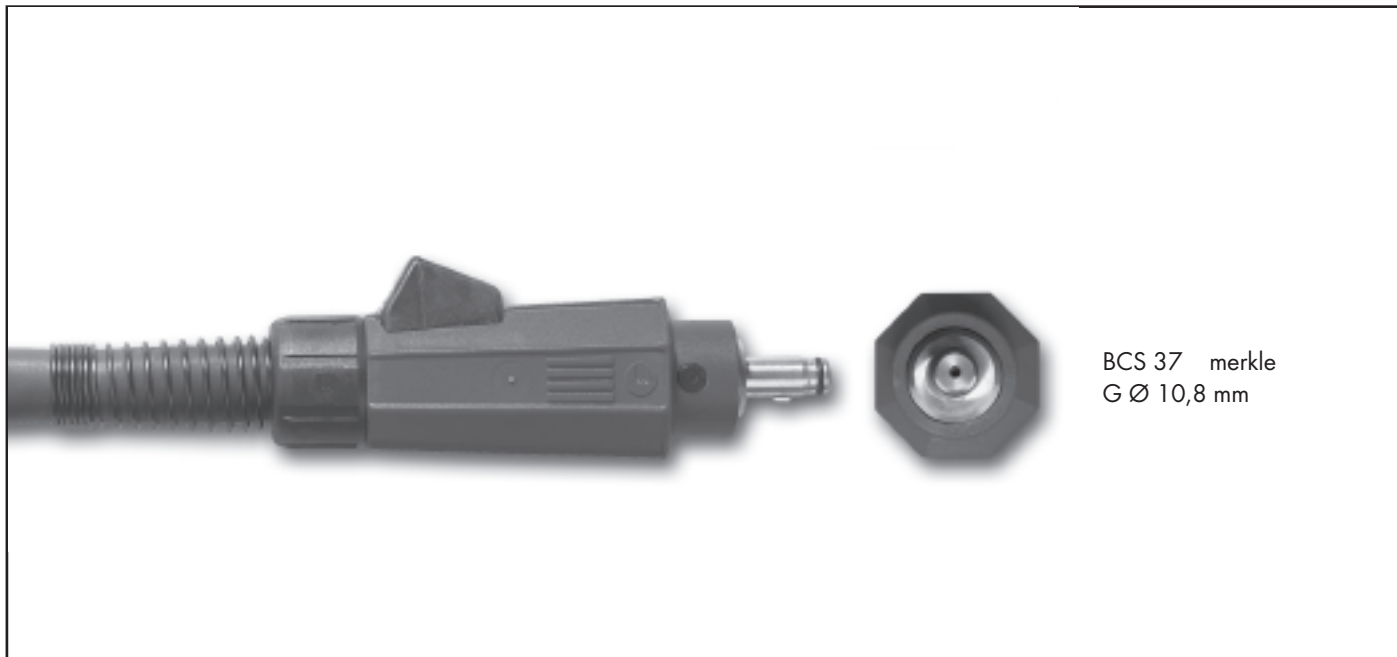

Brennertyp	Länge	maschinenseitiger Anschluss	Bestellnummer
ABITIG® 150 MT	4 m	TCG Anschluss merkle	7M410400- -37- - -00
	8 m	TCG Anschluss merkle	7M410800- -37- - -00
ABITIG® 200 MT*	4 m	TCG Anschluss merkle	7M4V0400- -37- - -00
	8 m	TCG Anschluss merkle	7M4V0800- -37- - -00

ABITIG®-Brennerpreisliste für MT Brenner (Automatenbrenner)

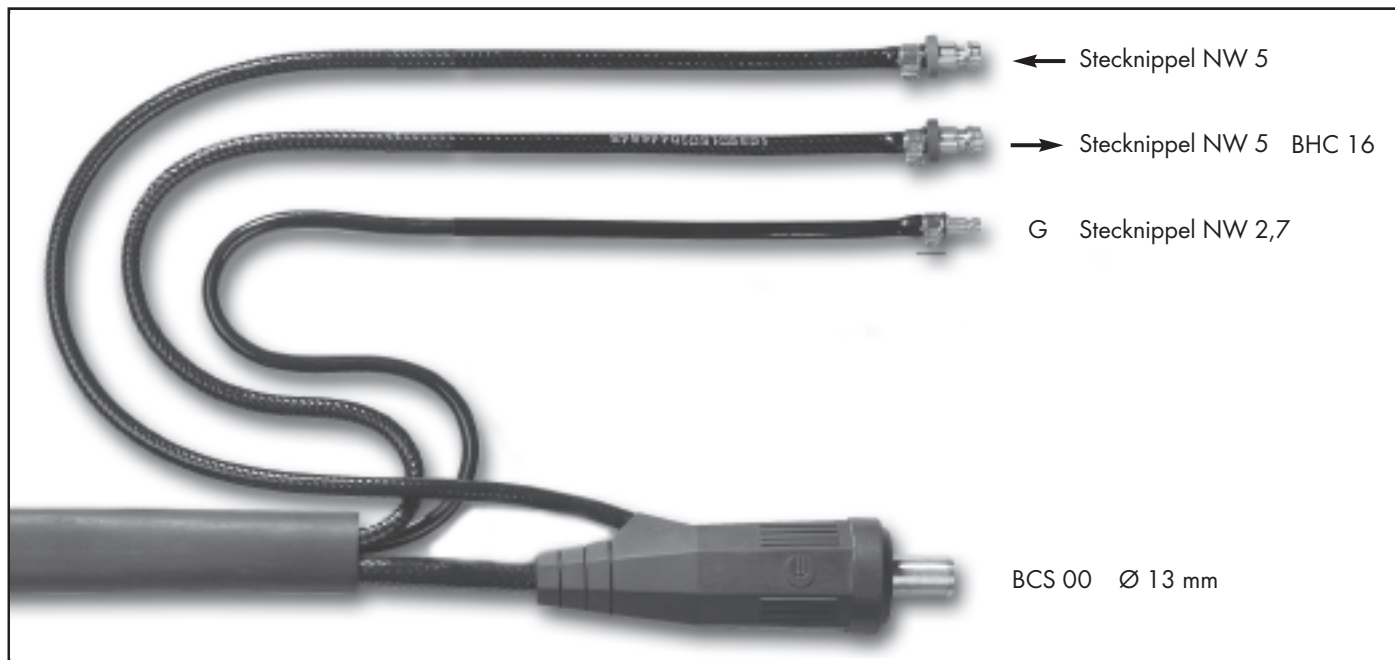

Brennertyp	Länge	maschinenseitiger Anschluss	Bestellnummer
ABITIG® 260 W MT	4 m	BSB 3550	7M510400- -00- - -16
	8 m	BSB 3550	7M510800- -00- - -16
ABITIG® 300 W MT*	4 m	BSB 3550	7M5V0400- -00- - -16
	8 m	BSB 3550	7M5V0800- -00- - -16
ABITIG® 400 W MT	4 m	BSB 3550	7M520400- -00- - -16
	8 m	BSB 3550	7M520800- -00- - -16
ABITIG® 500 W MT	4 m	BSB 3550	7M550400- -00- - -16
	8 m	BSB 3550	7M550800- -00- - -16

Technische Änderungen vorbehalten • Verkaufspreise = unverbindliche Preisempfehlung - Angebot freibleibend • © Copyright
* ABITIG 300 mit voreinstellbarer Elektrode

ABITIG®-Brennerpreisliste für MT Brenner (Automatenbrenner)

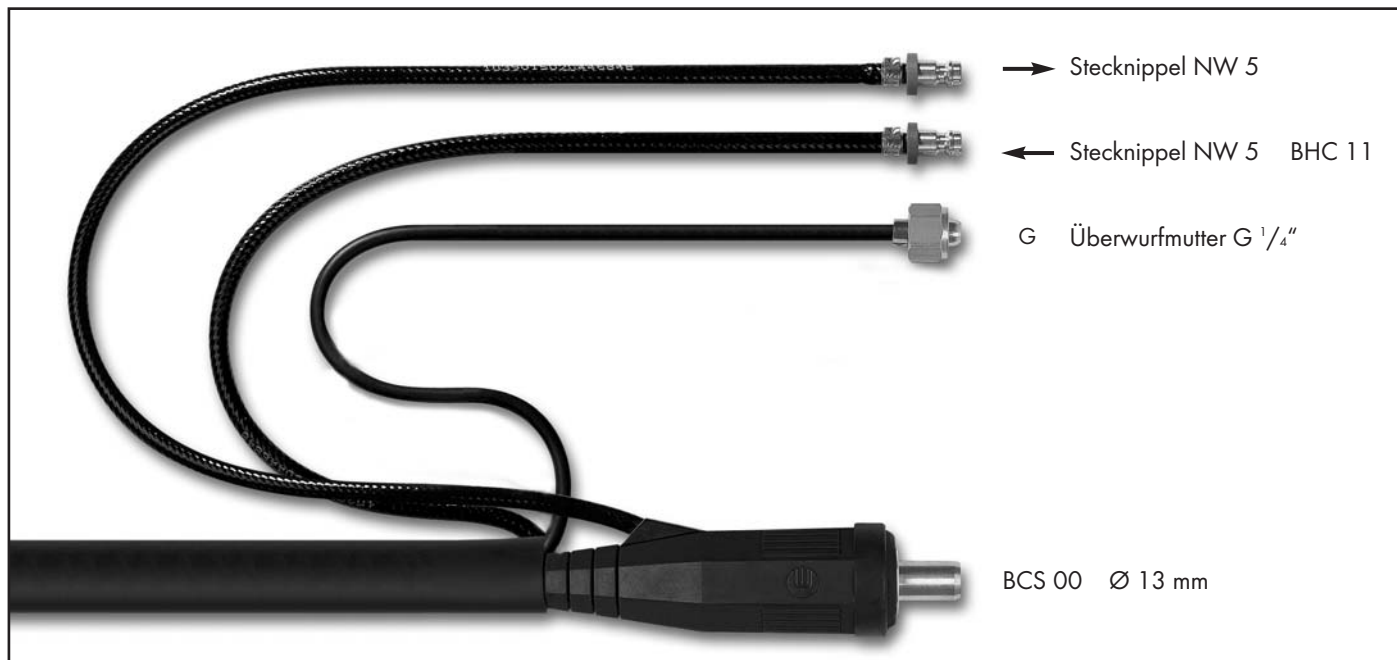

Brennertyp	Länge	maschinenseitiger Anschluss	Bestellnummer
ABITIG® 260 W MT	4 m	BSB 3550	7M510400- -00- - -11
	8 m	BSB 3550	7M510800- -00- - -11
ABITIG® 300 W MT*	4 m	BSB 3550	7M5V0400- -00- - -11
	8 m	BSB 3550	7M5V0800- -00- - -11
ABITIG® 400 W MT	4 m	BSB 3550	7M520400- -00- - -11
	8 m	BSB 3550	7M520800- -00- - -11
ABITIG® 500 W MT	4 m	BSB 3550	7M550400- -00- - -11
	8 m	BSB 3550	7M550800- -00- - -11

ABITIG®-Brennerpreisliste für MT Brenner (Automatenbrenner)

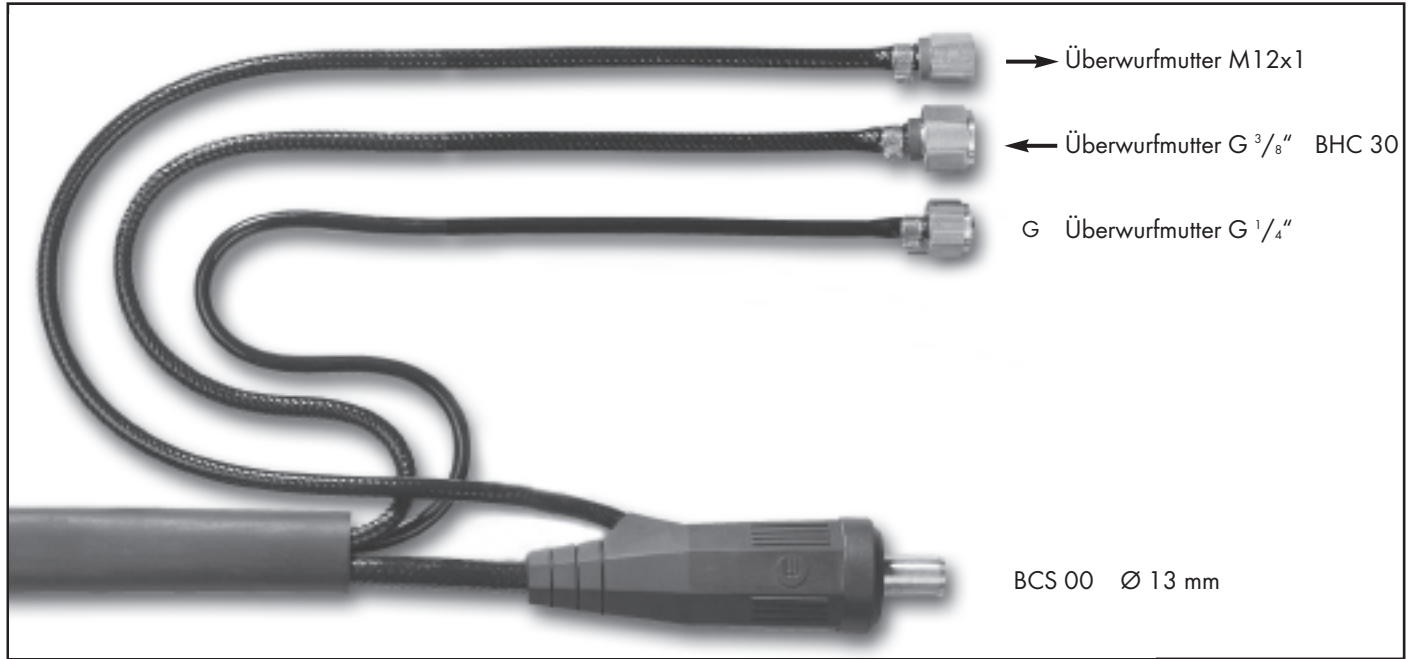

Brennertyp	Länge	maschinenseitiger Anschluss	Bestellnummer
ABITIG® 260 W MT	4 m	BSB 3550	7M510400- -00- - -30
	8 m	BSB 3550	7M510800- -00- - -30
ABITIG® 300 W MT*	4 m	BSB 3550	7M5V0400- -00- - -30
	8 m	BSB 3550	7M5V0800- -00- - -30
ABITIG® 400 W MT	4 m	BSB 3550	7M520400- -00- - -30
	8 m	BSB 3550	7M520800- -00- - -30
ABITIG® 500 W MT	4 m	BSB 3550	7M550400- -00- - -30
	8 m	BSB 3550	7M550800- -00- - -30

Technische Änderungen vorbehalten • Verkaufspreise = unverbindliche Preisempfehlung - Angebot freibleibend • © Copyright
* ABITIG 300 mit voreinstellbarer Elektrode

ABITIG®-Brennerpreisliste für MT Brenner (Automatenbrenner)

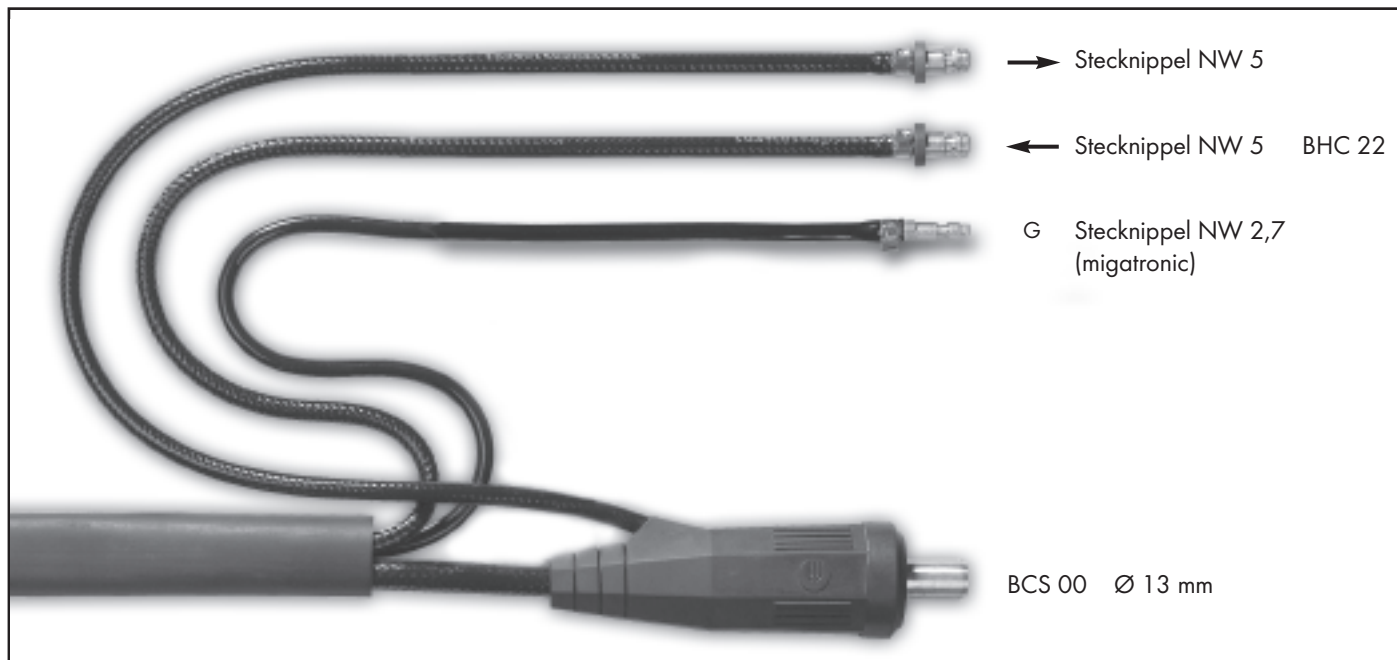

Brennertyp	Länge	maschinenseitiger Anschluss	Bestellnummer
ABITIG® 260 W MT	4 m	BSB 3550	7M510400- -00- - -22
	8 m	BSB 3550	7M510800- -00- - -22
ABITIG® 300 W MT*	4 m	BSB 3550	7M5V0400- -00- - -22
	8 m	BSB 3550	7M5V0800- -00- - -22
ABITIG® 400 W MT	4 m	BSB 3550	7M520400- -00- - -22
	8 m	BSB 3550	7M520800- -00- - -22
ABITIG® 500 W MT	4 m	BSB 3550	7M550400- -00- - -22
	8 m	BSB 3550	7M550800- -00- - -22

Technische Änderungen vorbehalten • Verkaufspreise = unverbindliche Preisempfehlung – Angebot freibleibend • © Copyright
* ABITIG 300 mit voreinstellbarer Elektrode

ABITIG®-Brennerpreisliste für MT Brenner (Automatenbrenner)

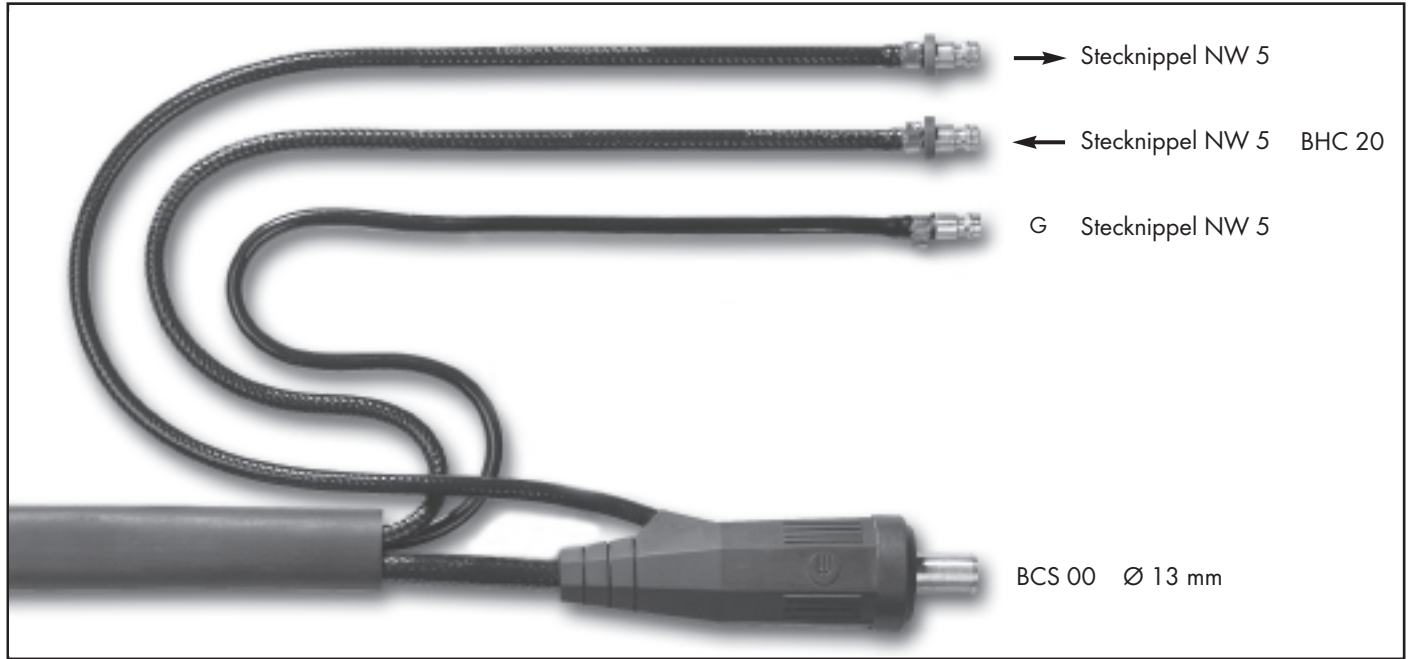

Brennertyp	Länge	maschinenseitiger Anschluss	Bestellnummer
ABITIG® 260 W MT	4 m	BSB 3550	7M510400- -00- - -20
	8 m	BSB 3550	7M510800- -00- - -20
ABITIG® 300 W MT*	4 m	BSB 3550	7M5V0400- -00- - -20
	8 m	BSB 3550	7M5V0800- -00- - -20
ABITIG® 400 W MT	4 m	BSB 3550	7M520400- -00- - -20
	8 m	BSB 3550	7M520800- -00- - -20
ABITIG® 500 W MT	4 m	BSB 3550	7M550400- -00- - -20
	8 m	BSB 3550	7M550800- -00- - -20

Technische Änderungen vorbehalten • Verkaufspreise = unverbindliche Preisempfehlung – Angebot freibleibend • © Copyright

* ABITIG 300 mit voreinstellbarer Elektrode

ABITIG®-Brennerpreisliste für MT Brenner (Automatenbrenner)

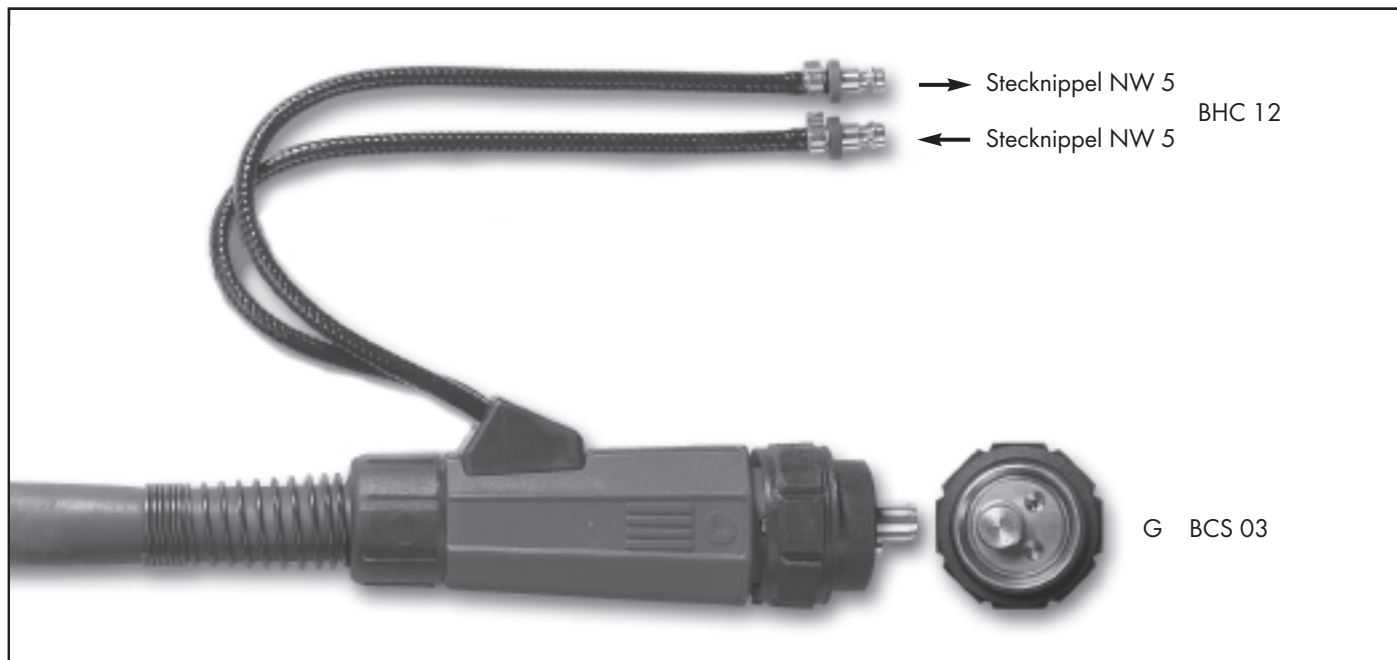

Brennertyp	Länge	maschinenseitiger Anschluss	Bestellnummer
ABITIG® 260 W MT	4 m	ZA WZ-0	7M510400- -03- - -12
	8 m	ZA WZ-0	7M510800- -03- - -12
ABITIG® 300 W MT*	4 m	ZA WZ-0	7M5V0400- -03- - -12
	8 m	ZA WZ-0	7M5V0800- -03- - -12
ABITIG® 400 W MT	4 m	ZA WZ-0	7M520400- -03- - -12
	8 m	ZA WZ-0	7M520800- -03- - -12
ABITIG® 500 W MT	4 m	ZA WZ-0	7M550400- -03- - -12
	8 m	ZA WZ-0	7M550800- -03- - -12

Technische Änderungen vorbehalten • Verkaufspreise = unverbindliche Preisempfehlung - Angebot freibleibend • © Copyright
* ABITIG 300 mit voreinstellbarer Elektrode

ABITIG®-Brennerpreisliste für MT Brenner (Automatenbrenner)

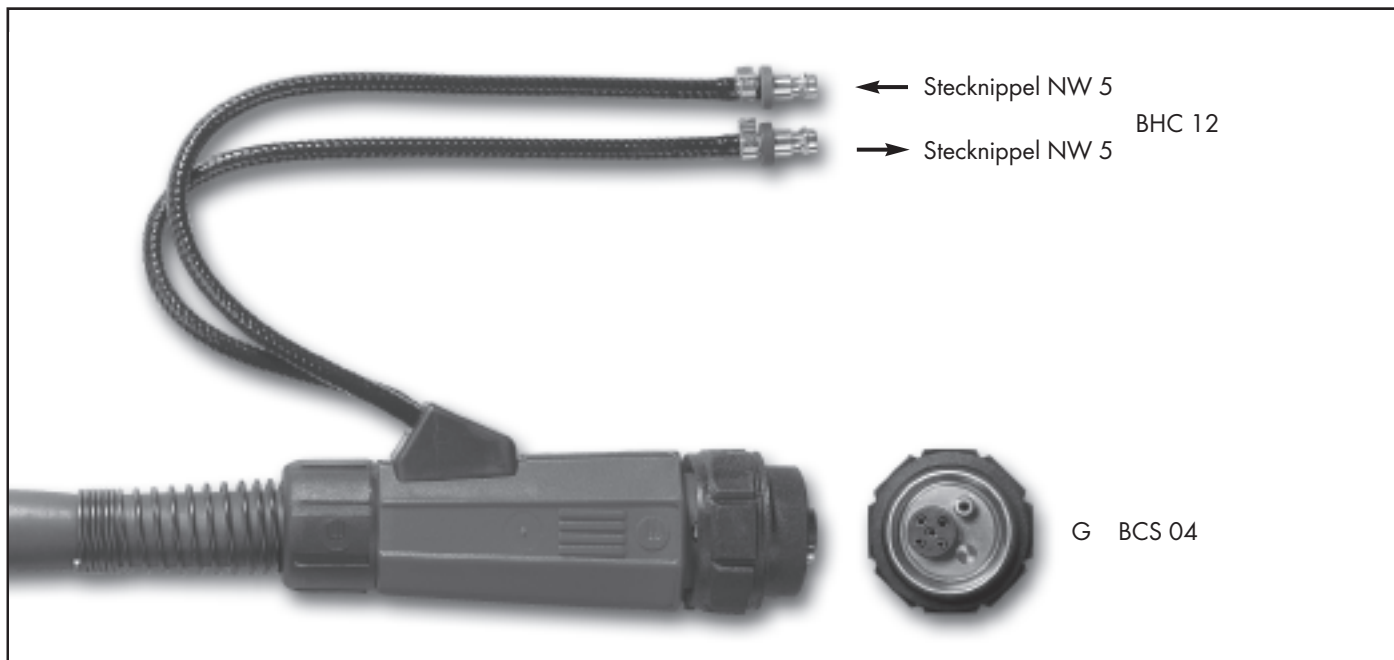

Brennertyp	Länge	maschinenseitiger Anschluss	Bestellnummer
ABITIG® 260 W MT	4 m	ZA WTW 5	7M510400- -04- - -12
	8 m	ZA WTW 5	7M510800- -04- - -12
ABITIG® 300 W MT*	4 m	ZA WTW 5	7M5V0400- -04- - -12
	8 m	ZA WTW 5	7M5V0800- -04- - -12
ABITIG® 400 W MT	4 m	ZA WTW 5	7M520400- -04- - -12
	8 m	ZA WTW 5	7M520800- -04- - -12
ABITIG® 500 W MT	4 m	ZA WTW 5	7M550400- -04- - -12
	8 m	ZA WTW 5	7M550800- -04- - -12

Technische Änderungen vorbehalten • Verkaufspreise = unverbindliche Preisempfehlung – Angebot freibleibend • © Copyright
* ABITIG 300 mit voreinstellbarer Elektrode

ABITIG®-Brennerpreisliste für MT Brenner (Automatenbrenner)

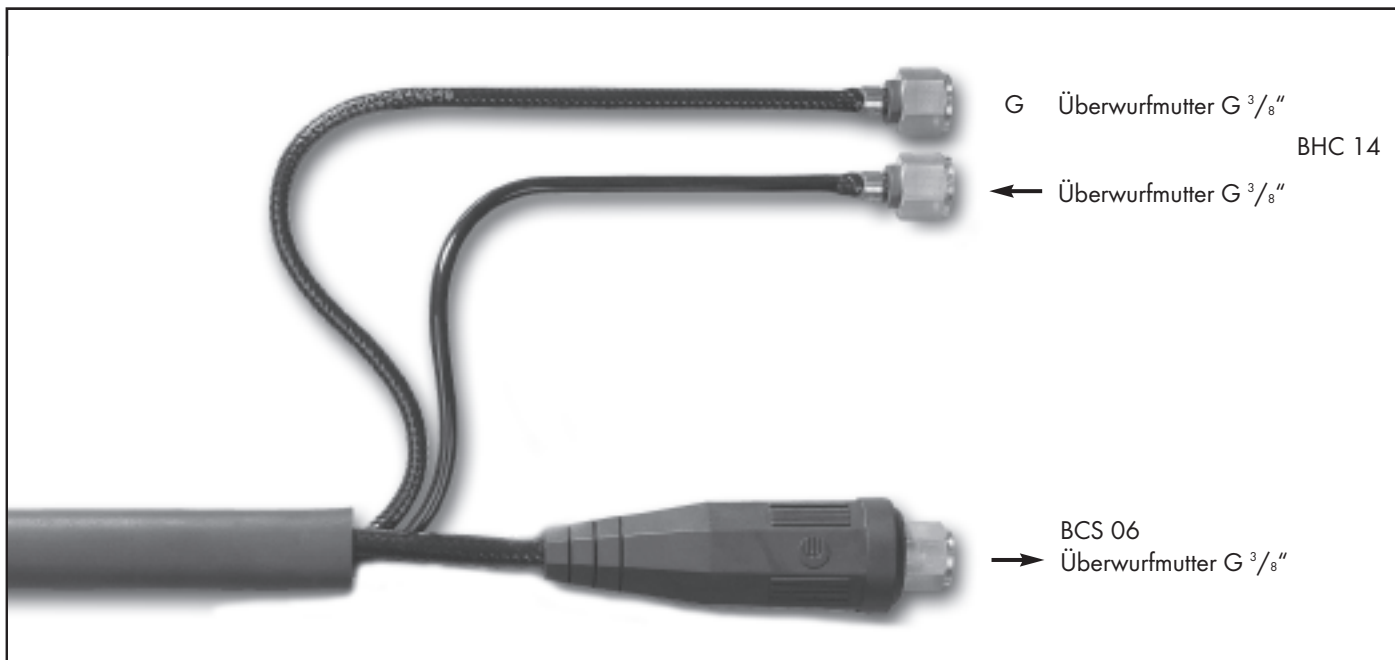

Brennertyp	Länge	maschinenseitiger Anschluss	Bestellnummer
ABITIG® 260 W MT	4 m	EA	7M510400- -06- - -14
	8 m	EA	7M510800- -06- - -14
ABITIG® 300 W MT*	4 m	EA	7M5V0400- -06- - -14
	8 m	EA	7M5V0800- -06- - -14
ABITIG® 400 W MT	4 m	EA	7M520400- -06- - -14
	8 m	EA	7M520800- -06- - -14
ABITIG® 500 W MT	4 m	EA	7M550400- -06- - -14
	8 m	EA	7M550800- -06- - -14

ABITIG®-Brennerpreisliste für MT Brenner (Automatenbrenner)

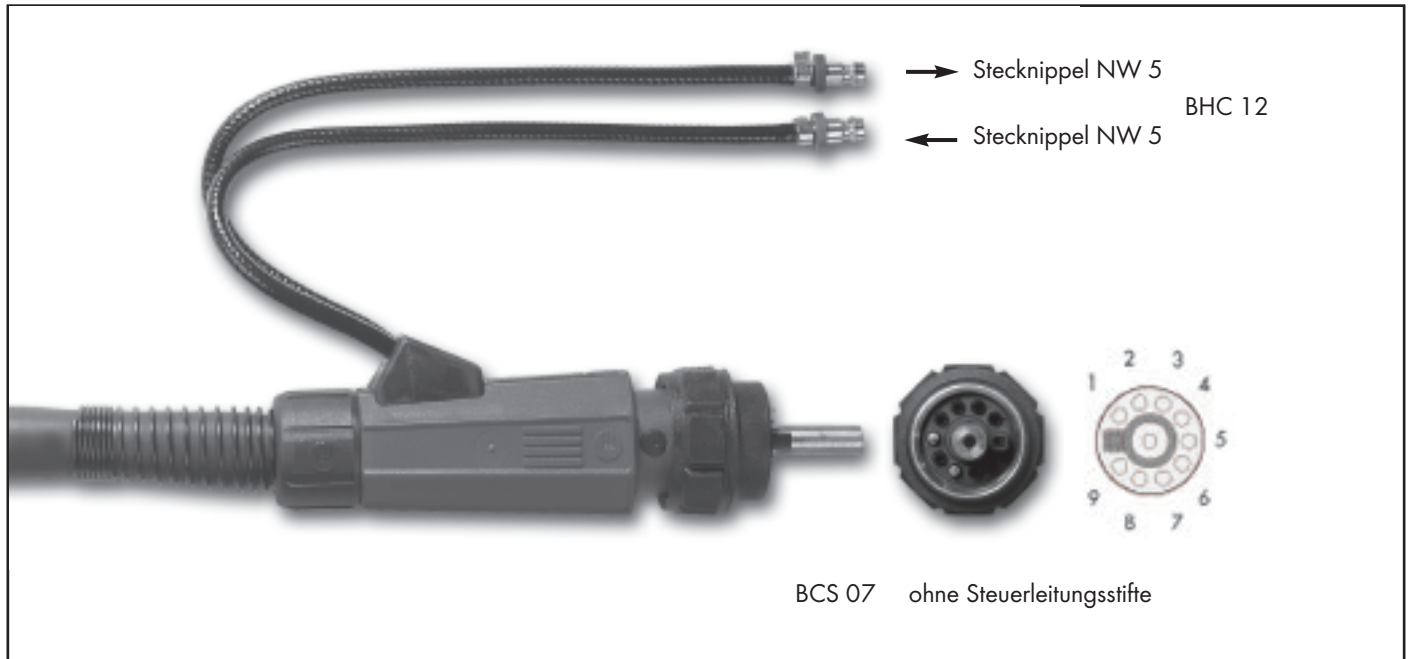

Brennertyp	Länge	maschinenseitiger Anschluss	Bestellnummer
ABITIG® 260 W MT	4 m	ZA 9-polig	7M510400- -07- - -12
	8 m	ZA 9-polig	7M510800- -07- - -12
ABITIG® 300 W MT*	4 m	ZA 9-polig	7M5V0400- -07- - -12
	8 m	ZA 9-polig	7M5V0800- -07- - -12
ABITIG® 400 W MT	4 m	ZA 9-polig	7M520400- -07- - -12
	8 m	ZA 9-polig	7M520800- -07- - -12
ABITIG® 500 W MT	4 m	ZA 9-polig	7M550400- -07- - -12
	8 m	ZA 9-polig	7M550800- -07- - -12

Technische Änderungen vorbehalten • Verkaufspreise = unverbindliche Preisempfehlung – Angebot freibleibend • © Copyright

* ABITIG 300 mit voreinstellbarer Elektrode

ABITIG®-Brennerpreisliste für MT Brenner (Automatenbrenner)

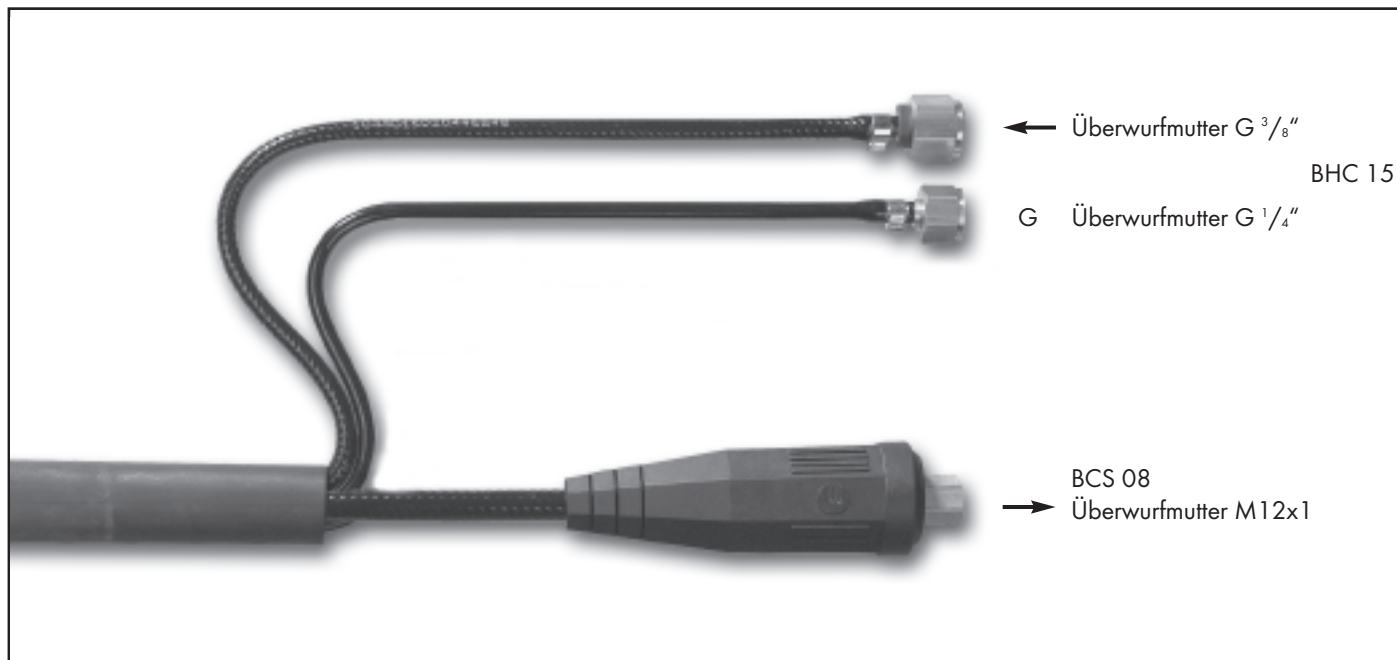

Brennertyp	Länge	maschinenseitiger Anschluss	Bestellnummer
ABITIG® 260 W MT	4 m	EA	7M510400- -08- - -15
	8 m	EA	7M510800- -08- - -15
ABITIG® 300 W MT*	4 m	EA	7M5V0400- -08- - -15
	8 m	EA	7M5V0800- -08- - -15
ABITIG® 400 W MT	4 m	EA	7M520400- -08- - -15
	8 m	EA	7M520800- -08- - -15
ABITIG® 500 W MT	4 m	EA	7M550400- -08- - -15
	8 m	EA	7M550800- -08- - -15

ABITIG®-Brennerpreisliste für MT Brenner (Automatenbrenner)



Brennertyp	Länge	maschinenseitiger Anschluss	Bestellnummer
ABITIG® 260 W MT	4 m	oerlikon ZA	7M510400- -19- - -00
	8 m	oerlikon ZA	7M510800- -19- - -00
ABITIG® 300 W MT*	4 m	oerlikon ZA	7M5V0400- -19- - -00
	8 m	oerlikon ZA	7M5V0800- -19- - -00
ABITIG® 400 W MT	4 m	oerlikon ZA	7M520400- -19- - -00
	8 m	oerlikon ZA	7M520800- -19- - -00
ABITIG® 500 W MT	4 m	oerlikon ZA	7M550400- -19- - -00
	8 m	oerlikon ZA	7M550800- -19- - -00

Technische Änderungen vorbehalten • Verkaufspreise = unverbindliche Preisempfehlung – Angebot freibleibend • © Copyright
* ABITIG 300 mit voreinstellbarer Elektrode

ABITIG®-Brennerpreisliste für MT Brenner (Automatenbrenner)

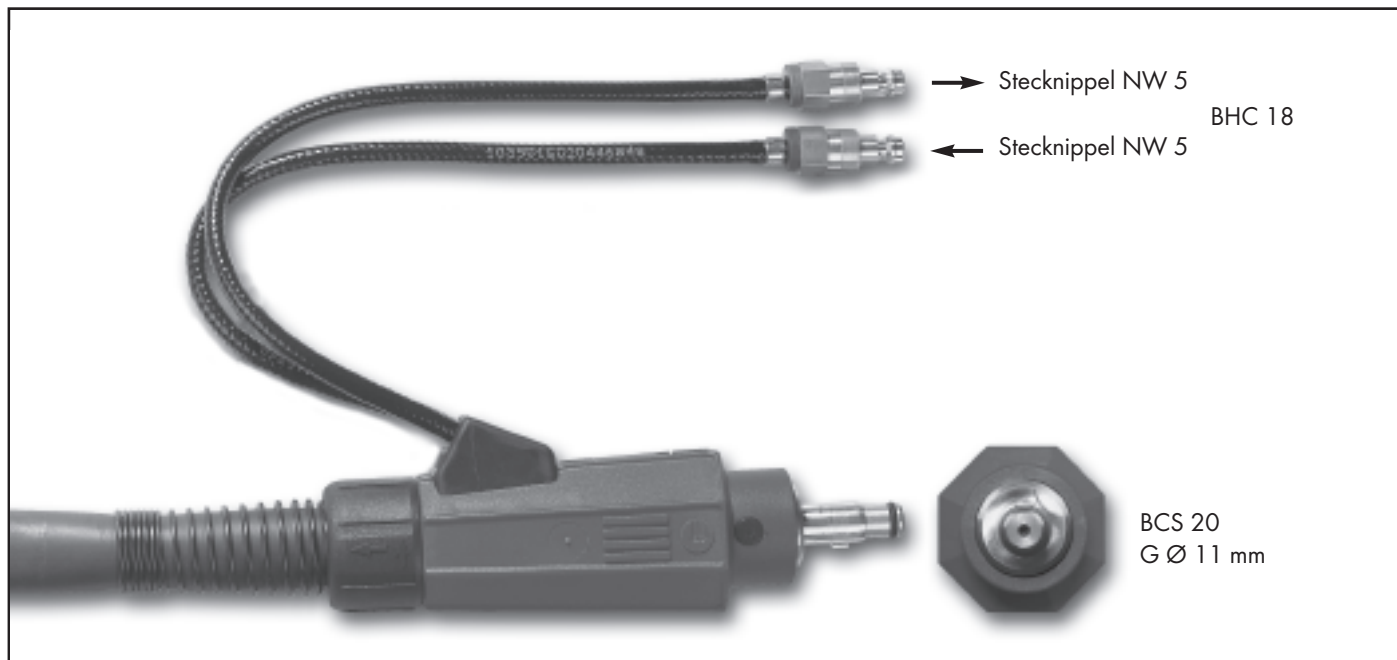

Brennertyp	Länge	maschinenseitiger Anschluss	Bestellnummer
ABITIG® 260 W MT	4 m	dalex BSB CG	7M510400- -20- - -18
	8 m	dalex BSB CG	7M510800- -20- - -18
ABITIG® 300 W MT*	4 m	dalex BSB CG	7M5V0400- -20- - -18
	8 m	dalex BSB CG	7M5V0800- -20- - -18
ABITIG® 400 W MT	4 m	dalex BSB CG	7M520400- -20- - -18
	8 m	dalex BSB CG	7M520800- -20- - -18
ABITIG® 500 W MT	4 m	dalex BSB CG	7M550400- -20- - -18
	8 m	dalex BSB CG	7M550800- -20- - -18

Technische Änderungen vorbehalten • Verkaufspreise = unverbindliche Preisempfehlung – Angebot freibleibend • © Copyright
* ABITIG 300 mit voreinstellbarer Elektrode

ABITIG®-Brennerpreisliste für MT Brenner (Automatenbrenner)

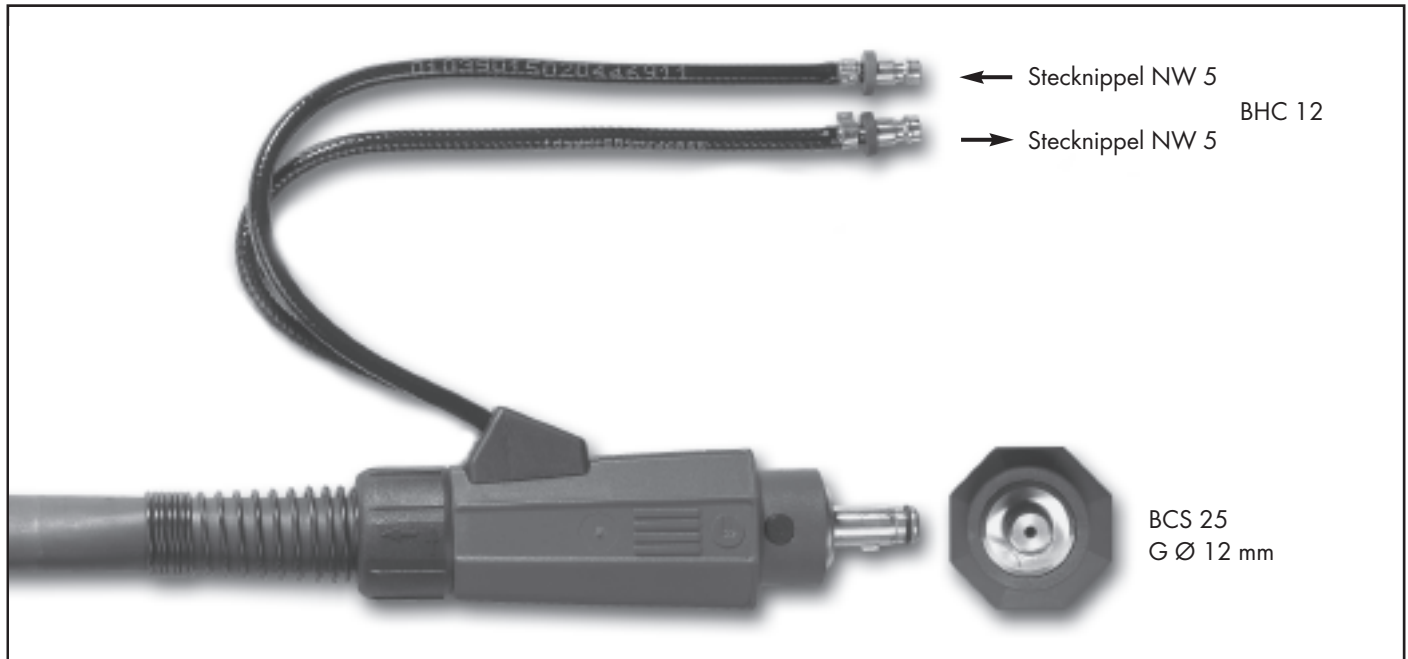

Brennertyp	Länge	maschinenseitiger Anschluss	Bestellnummer
ABITIG® 260 W MT	4 m	oerlikon BSB CG	7M510400- -25- - -12
	8 m	oerlikon BSB CG	7M510800- -25- - -12
ABITIG® 300 W MT*	4 m	oerlikon BSB CG	7M5V0400- -25- - -12
	8 m	oerlikon BSB CG	7M5V0800- -25- - -12
ABITIG® 400 W MT	4 m	oerlikon BSB CG	7M520400- -25- - -12
	8 m	oerlikon BSB CG	7M520800- -25- - -12
ABITIG® 500 W MT	4 m	oerlikon BSB CG	7M550400- -25- - -12
	8 m	oerlikon BSB CG	7M550800- -25- - -12

Technische Änderungen vorbehalten • Verkaufspreise = unverbindliche Preisempfehlung - Angebot freibleibend • © Copyright
* ABITIG 300 mit voreinstellbarer Elektrode

ABITIG®-Brennerpreisliste für MT Brenner (Automatenbrenner)

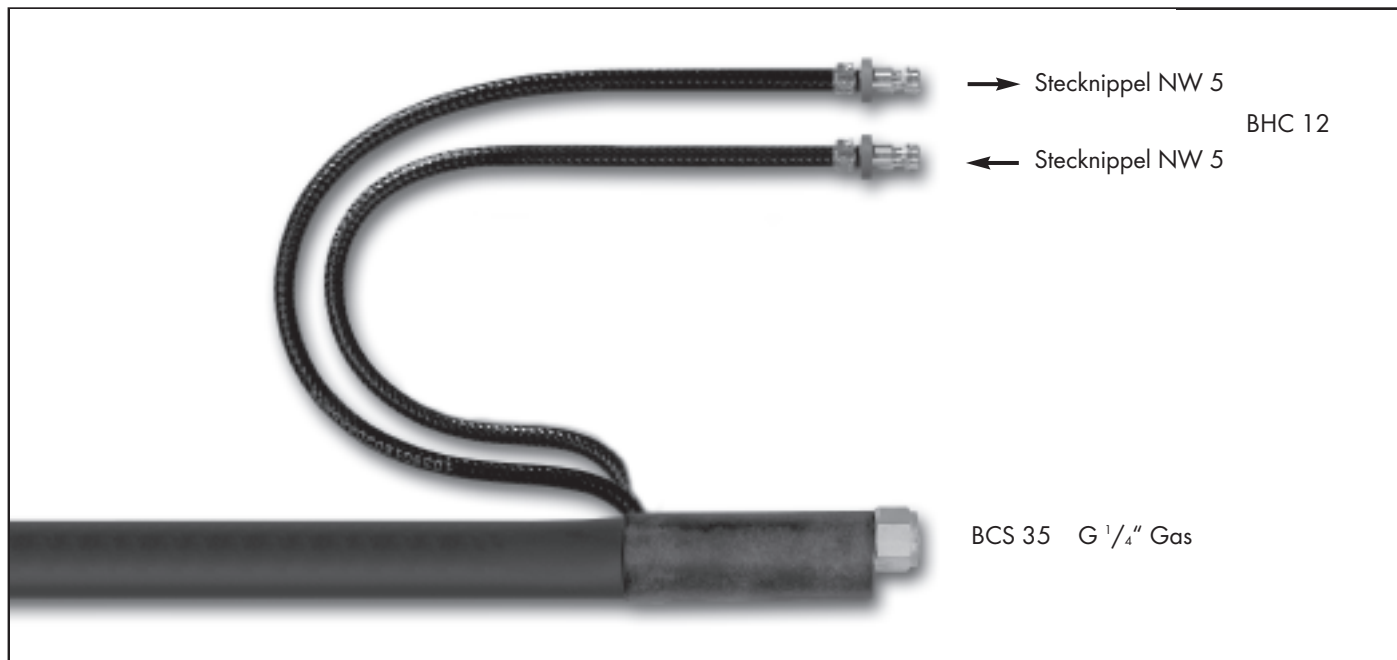

Brennertyp	Länge	maschinenseitiger Anschluss	Bestellnummer
ABITIG® 260 W MT	4 m	kemppi EA	7M510400- -35- - -12
	8 m	kemppi EA	7M510800- -35- - -12
ABITIG® 300 W MT*	4 m	kemppi EA	7M5V0400- -35- - -12
	8 m	kemppi EA	7M5V0800- -35- - -12
ABITIG® 400 W MT	4 m	kemppi EA	7M520400- -35- - -12
	8 m	kemppi EA	7M520800- -35- - -12
ABITIG® 500 W MT	4 m	kemppi EA	7M550400- -35- - -12
	8 m	kemppi EA	7M550800- -35- - -12

ABITIG®-Brennerpreisliste für MT Brenner (Automatenbrenner)

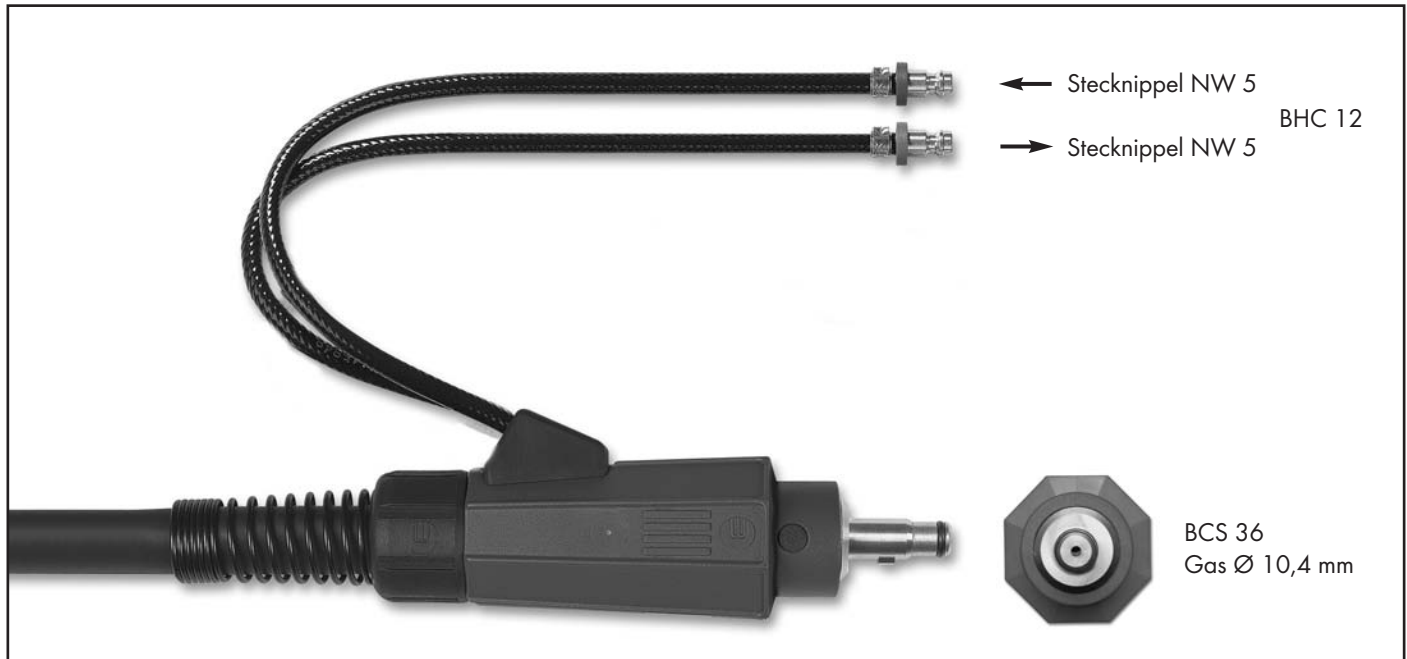

Brennertyp	Länge	maschinenseitiger Anschluss	Bestellnummer
ABITIG®	4 m	TTW Anschluss Fronius	7M510400- -36- - -12
	8 m	TTW Anschluss Fronius	7M510800- -36- - -12
ABITIG® 300 W MT*	4 m	TTW Anschluss Fronius	7M5V0400- -36- - -12
	8 m	TTW Anschluss Fronius	7M5V0800- -36- - -12
ABITIG® 400 W MT	4 m	TTW Anschluss Fronius	7M520400- -36- - -12
	8 m	TTW Anschluss Fronius	7M520800- -36- - -12
ABITIG® 500 W MT	4 m	TTW Anschluss Fronius	7M550400- -36- - -12
	8 m	TTW Anschluss Fronius	7M550800- -36- - -12

Technische Änderungen vorbehalten • Verkaufspreise = unverbindliche Preisempfehlung – Angebot freibleibend • © Copyright
* ABITIG 300 mit voreinstellbarer Elektrode

ABITIG®-Brennerpreisliste für MT Brenner (Automatenbrenner)

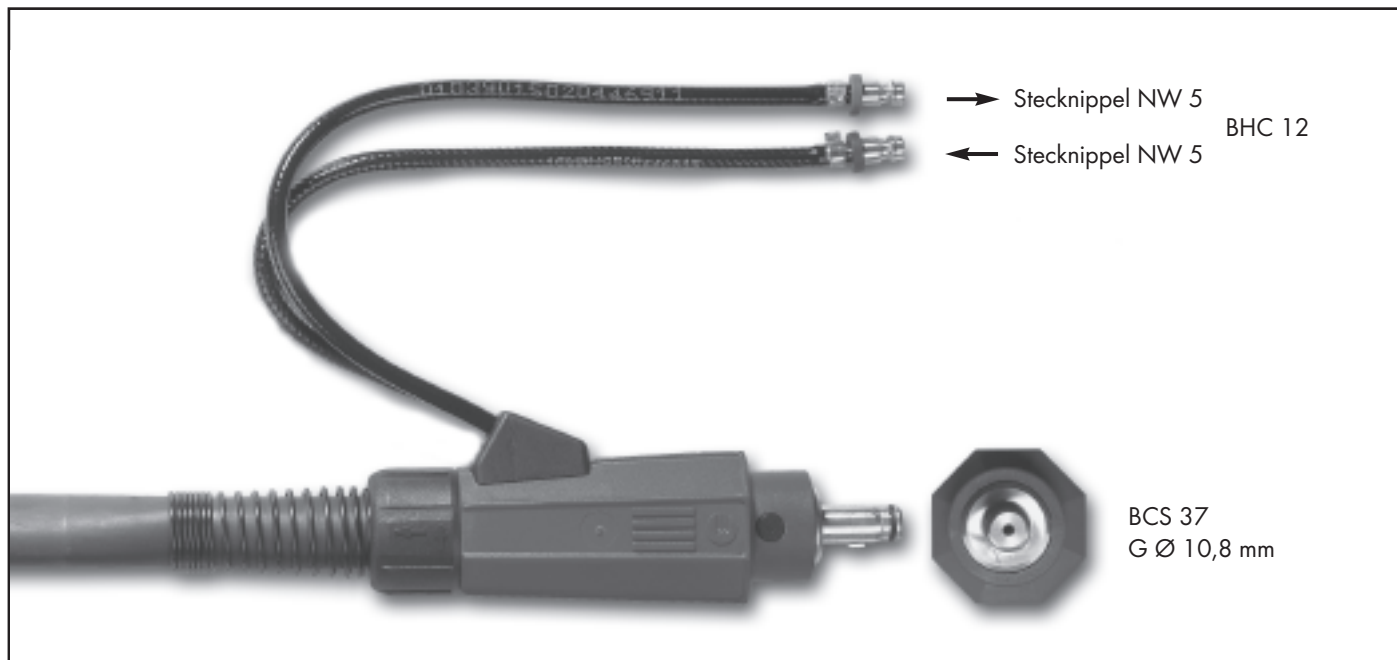

Brennertyp	Länge	maschinenseitiger Anschluss	Bestellnummer
ABITIG® 260 W MT	4 m	TCG Anschluss merkle	7M510400- -37- - -12
	8 m	TCG Anschluss merkle	7M510800- -37- - -12
ABITIG® 300 W MT*	4 m	TCG Anschluss merkle	7M5V0400- -37- - -12
	8 m	TCG Anschluss merkle	7M5V0800- -37- - -12
ABITIG® 400 W MT	4 m	TCG Anschluss merkle	7M520400- -37- - -12
	8 m	TCG Anschluss merkle	7M520800- -37- - -12
ABITIG® 500 W MT	4 m	TCG Anschluss merkle	7M550400- -37- - -12
	8 m	TCG Anschluss merkle	7M550800- -37- - -12

ABITIG®-Brennerpreisliste

Ventilbrenner

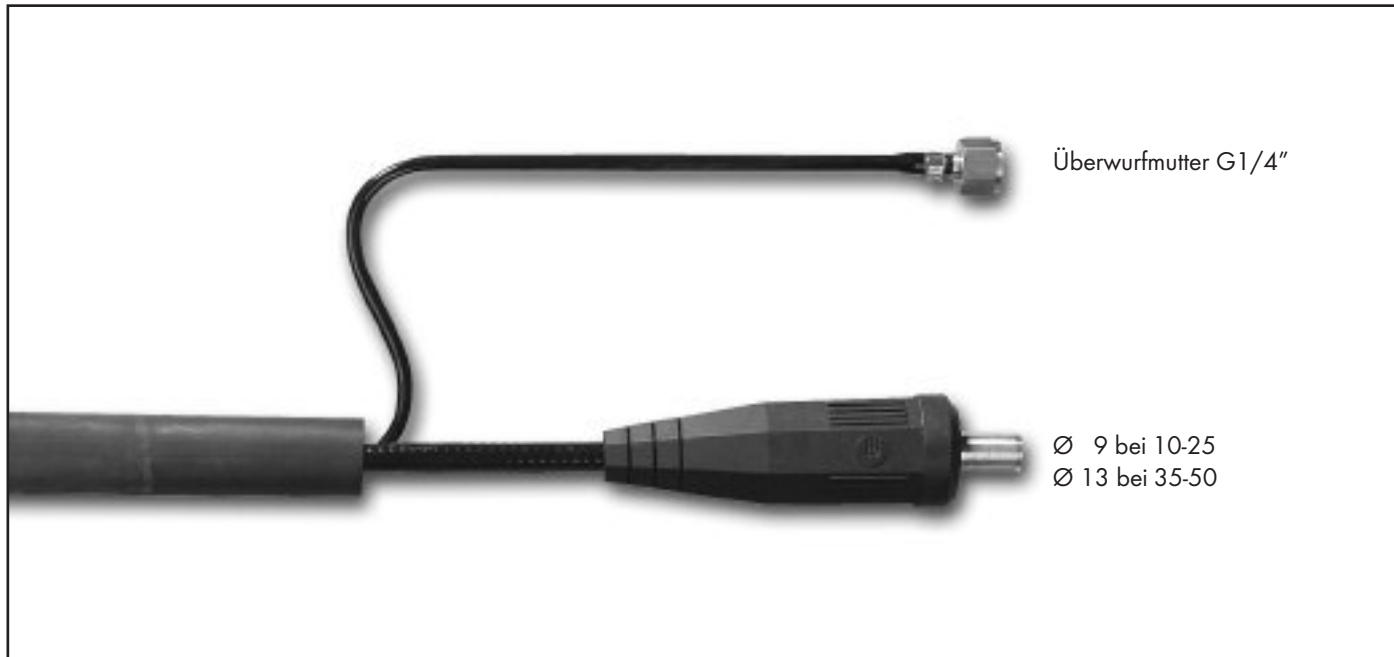

Brennertyp	Länge	Schalterfunktion	maschinenseitiger Anschluss	Schlauchpaketausführung	Bestellnummer
ABITIG® 9 V	4 m	Drehventil	Stecker 10 - 25	Standard	706.5057
	8 m	Drehventil	Stecker 10 - 25	Standard	706.5058
ABITIG® 17 V	4 m	Drehventil	Stecker 10 - 25	Standard	706.1057
	8 m	Drehventil	Stecker 10 - 25	Standard	706.1058
	4 m	Drehventil	Stecker 35 - 50	Standard	706.1037
	8 m	Drehventil	Stecker 35 - 50	Standard	706.1038
ABITIG® 17 FV	4 m	Drehventil	Stecker 10 - 25	Standard	706.1157
	8 m	Drehventil	Stecker 10 - 25	Standard	706.1158
	4 m	Drehventil	Stecker 35 - 50	Standard	706.1137
	8 m	Drehventil	Stecker 35 - 50	Standard	706.1138
ABITIG® 26 V	4 m	Drehventil	Stecker 35 - 50	Standard	706.4037
	8 m	Drehventil	Stecker 35 - 50	Standard	706.4038
ABITIG® 26 FV	4 m	Drehventil	Stecker 35 - 50	Standard	706.4137
	8 m	Drehventil	Stecker 35 - 50	Standard	706.4138

Allgemeine Liefer- und Leistungsbedingungen (Verkaufsbedingungen) der Alexander Binzel Schweisstechnik GmbH & Co. KG

§ 1 Geltung der Geschäftsbedingungen

- 1.1. Unsere sämtlichen Lieferungen, Leistungen und Angebote erfolgen ausschließlich aufgrund dieser allgemeinen Liefer- und Leistungsbedingungen (im Folgenden „diese Geschäftsbedingungen“). Diese Geschäftsbedingungen sind Bestandteil aller Verträge, die wir mit unseren Vertragspartnern (im Folgenden „Abnehmer“) schließen.
- 1.2. Allgemeine Geschäftsbedingungen des Abnehmers finden keine Anwendung, auch wenn wir ihrer Geltung im Einzelfall nicht gesondert widersprechen. Auch unter Bezugnahme auf ein Schreiben, das allgemeine Geschäftsbedingungen des Abnehmers oder eines Dritten enthält oder auf solche verweist, liegt kein Einverständnis mit der Geltung jener allgemeinen Geschäftsbedingungen vor. Diese werden auch nicht durch schlüssige Handlungen, wie beispielsweise die Erbringung einer Leistung durch uns, Vertragsbestandteil.
- 1.3. Diese Geschäftsbedingungen gelten für alle Verträge über Lieferungen und Leistungen unsererseits, sowie sämtliche Nebenleistungen. Auch ohne eine gesonderte Vereinbarung der Einbeziehung gelten diese Geschäftsbedingungen für alle zukünftigen Lieferungen und Leistungen unsererseits.

§ 2 Angebot und Vertragsabschluss

- 2.1. Soweit unsere Angebote ausdrücklich als freibleibend gekennzeichnet sind, können wir diese auch nach Zugang der Annahme durch den Abnehmer unverzüglich widerrufen.
- 2.2. An von uns abgegebenen Angeboten, Kostenvoranschlägen, von uns oder Dritten stammenden, dem Abnehmer zur Verfügung gestellten Zeichnungen, Abbildungen, Berechnungen, Beschreibungen, Modellen, Werkzeugen und anderen Unterlagen und Hilfsmittel erwirbt der Abnehmer kein Urheberrecht. Dies gilt auch für solche der erwähnten Materialien und Unterlagen, die ausdrücklich als „vertraulich“ gekennzeichnet sind, oder deren vertraulicher Charakter sich aus den Umständen ergibt. Die Weitergabe der genannten Materialien und Dokumente an Dritte bedarf in jedem Fall unserer Zustimmung. Der Abnehmer hat dies durch entsprechende Vereinbarungen mit seinen Angestellten oder sonstigen Personen, die mit Wissen und Wollen in seinen Pflichtenkreis tätig werden, sicherzustellen. Die genannten Materialien und Unterlagen sind unverzüglich auf Kosten des Abnehmers zurückzugeben, soweit ein Vertrag nicht zustande kommt oder sie für die weitere Vertragsdurchführung nicht mehr benötigt werden.

§ 3 Preise

- 3.1. Sofern sich aus der Auftragsbestätigung nichts anderes ergibt, gelten unsere Preise „ab Werk“, ausschließlich Verpackung; diese wird gesondert in Rechnung gestellt.
- 3.2. Die gesetzliche Mehrwertsteuer ist nicht in unseren Preisen eingeschlossen. Sie wird in der vom Gesetz vorgegebenen Höhe am Tag der Rechnungsstellung in der Rechnung gesondert ausgewiesen. Bei Auslandsgeschäften entfällt die Mehrwertsteuer; der Empfänger hat jedoch die für den Transfer in das Empfängerland anfallenden Abgaben und Gebühren, insbesondere Zölle, und die darüber hinaus im Empfängerland selbst anfallenden gesetzlichen Abgaben oder Gebühren zu tragen.
- 3.3. Der Abzug von Skonto bedarf einer gesonderten Vereinbarung. Allgemeine Geschäftsbedingungen des Abnehmers, die den Abzug von Skonto vorsehen, gelten nicht.

§ 4 Ausführung der Lieferungen und Leistungen, Liefer- und Leistungszeiten

- 4.1. Sofern nichts anderes vereinbart ist, erfolgt die Lieferung „ab Werk“.
- 4.2. Der Beginn der von uns angegebenen Liefer- oder Leistungszeit setzt die Abklärung aller technischen Fragen voraus.
- 4.3. Die Einhaltung unserer Liefer- oder Leistungsverpflichtungen setzt weiter die rechtzeitige und ordnungsgemäße Erfüllung des Abnehmers voraus. Die Einrede des nicht erfüllten Vertrags steht uns in vollem Umfang zu.
- 4.4. Kommt der Besteller in Annahmeverzug oder verletzt er sonstige Mitwirkungspflichten, so sind wir berechtigt, den uns insoweit entstehenden Schaden einschließlich etwaiger Mehraufwendungen ersetzt zu verlangen. Weitergehende Ansprüche bleiben unberührt.
- 4.5. Soweit die Voraussetzungen von § 4 Abs. 4 vorliegen, geht die Gefahr eines zufälligen Untergangs oder einer zufälligen Verschlechterung der zu liefernden oder zu leistenden Sache in dem Zeitpunkt auf den Abnehmer über, in dem dieser in Annahmeverzug gerät.
- 4.6. Soweit mit dem Abnehmer vereinbart wurde, dass unsere Lieferung oder Leistung nicht zu einem festen Termin, sondern innerhalb eines bestimmten Zeitraums zu erfolgen hat, sind wir berechtigt, auch vor Ablauf des Zeitraums zu liefern oder unsere Leistung zu erbringen. Soweit mit dem Abnehmer ein fester Liefertermin vereinbart wurde, sind wir, nachdem wir dem Abnehmer eine angemessene Zeit vor Lieferung oder Erbringung der Leistung dies angezeigt haben, zur vorzeitigen Lieferung oder Erbringung der Leistung berechtigt. Dies gilt nicht, wenn aus für uns erkennbaren Gründen die Lieferung nur zu dem vereinbarten Termin erfolgen kann.
- 4.7. Sofern nichts anderes vereinbart ist, ist der Abnehmer bei solchen Verträgen, die ihn zum Abruf von Teillieferungen aus einer Gesamtmenge von Waren berechtigen, verpflichtet, uns rechtzeitige Abrufe und Sorteneinteilungen für un-gleichartige Monatsmengen aufzugeben. Ruft der Abnehmer nicht rechtzeitig ab oder teilt er nicht rechtzeitig ein, so sind wir nach fruchtlosem Verstreichen einer angemessenen Nachfrist dazu berechtigt, die Einteilung selbst vorzunehmen und die Ware zu liefern.
Ruft der Abnehmer mehrfach nicht oder nicht rechtzeitig ab oder teilt er mehrfach nicht oder nicht rechtzeitig ein, so sind wir nach vorheriger Abmahnung berechtigt, vom gesamten Vertrag zurückzutreten. Die uns gesetzlich zustehenden Schadenersatzansprüche bleiben in jedem Fall unberührt.
- 4.8. Bei Abrufaufträgen nach § 4 Abs. 7 dieser Geschäftsbedingungen sind wir berechtigt, soweit keine abweichende Vereinbarung getroffen wurde, das Material für den gesamten Auftrag zu beschaffen und die gesamte Bestellmenge sofort herzustellen. Änderungswünsche des Abnehmers können nach Auftragserteilung nicht mehr berücksichtigt werden.
- 4.9. Handelsübliche Mehr- oder Minderlieferungen sind zulässig.

§ 5 Lieferverzögerung

- 5.1. Betriebsstörungen durch höhere Gewalt, nicht von uns zu vertretende Streiks oder Aussperrungen oder Betriebs- und/oder Rohstoffmangel berechtigen uns, vom noch nicht erfüllten Vertrag zurückzutreten, wenn die genannten Umstände die Lieferung oder Leistung nicht nur vorübergehend unmöglich machen und darüber hinaus bei Vertragsabschluss nicht erkennbar waren.
- 5.2. Geraten wir mit einer Lieferung oder Leistung in Verzug oder wird uns eine Lieferung oder Leistung unmöglich, so ist ein Schadenersatzanspruch des Abnehmers nach Maßgabe des § 9 dieser Geschäftsbedingungen beschränkt.

§ 6 Erfüllungsort, Versand, Verpackung, Gefahrenübergang

- 6.1. Erfüllungsort für alle Verpflichtungen aus dem Vertragsverhältnis mit dem Abnehmer ist Buseck/Alten-Buseck.
- 6.2. Soweit nichts anderes vereinbart ist, werden wir die uns bekannte preisgünstigste Verpackung und die uns bekannte preisgünstigste Versandart wählen.
- 6.3. Die Gefahr geht spätestens mit Übergabe des Liefergegenstands an den Spediteur, Frachtführer oder das sonst zur Ausführung der Versendung bestimmte Unternehmen auf den Abnehmer über, soweit nichts anderes vereinbart ist. § 4 Abs. 4 bleibt unberührt.
- 6.4. Die Sendung wird von uns nur auf ausdrücklichen schriftlichen Wunsch des Abnehmers und auf seine Kosten gegen Diebstahl, Bruch, Transport, Feuer und Wasserschäden oder sonstige versicherbare Risiken versichert.
- 6.5. Die Rücknahme von Verpackungen erfolgt ausschließlich in unseren Lagern (Rücknahmestellen). Die Kosten für den Transport von Verpackungen zu der jeweiligen Rücknahmestelle trägt der Abnehmer. Wird auf Wunsch des Abnehmers eine vom Standard abweichende Verpackung (Sonderverpackung) verwendet, ist der Abnehmer verpflichtet, diese auf eigene Kosten zu verwerten oder zu entsorgen.

§ 7 Ansprüche wegen Sachmängeln

- 7.1. Die von uns gelieferten Gegenstände sind unverzüglich nach Ablieferung an den Abnehmer oder an den von ihm bestimmten Dritten sorgfältig zu untersuchen. Sie gelten als genehmigt, wenn ein Mangel, der bei sorgfältiger Untersuchung zu entdecken gewesen wäre, nicht binnen drei Tagen nach Wareneingang schriftlich gerügt wird, wobei die Absendung der Rüge an uns entscheidend ist. War der Mangel bei der sorgfältigen Untersuchung nicht erkennbar, so gilt die Pflicht zur unverzüglichen schriftlichen Rüge ab dem Zeitpunkt der Entdeckung.
- 7.2. Soweit ein von uns zu vertretender Mangel der Lieferung oder Leistung vorliegt, sind wir nach unserer Wahl zur Mangelbeseitigung oder zur Ersatzlieferung verpflichtet. Im Fall der Mangelbeseitigung sind wir verpflichtet, alle zum Zweck der Mangelbeseitigung erforderlichen Aufwendungen, insbesondere Transport-, Wege-, Arbeits- und Materialkosten zu tragen, soweit sich diese nicht dadurch erhöhen, dass die Kaufsache an einen anderen Ort als dem ursprünglichen Versendungsort verbracht wurde. Dies gilt nicht, wenn das Verbringen an einen anderen Ort dem bestimmungsgemäßen Gebrauch des Liefergegenstandes entspricht. Soweit wir die Nacherfüllung in Form der Nachlieferung wählen, sind die mangelbehafteten Liefergegenstände frachtfrei an uns zurückzusenden, wobei der Abnehmer verpflichtet ist, die preisgünstigste Versandart zu wählen.
- 7.3. Die Verjährungsfrist für Ansprüche wegen Sachmängeln beträgt ein Jahr und beginnt mit dem Zeitpunkt der Ablieferung beim Abnehmer oder einem vom Abnehmer bestimmten Dritten.
- 7.4. Die Lieferung gebrauchter Sachen erfolgt unter Ausschluss jeglicher Gewährleistung.

§ 8 Verbrauchsgüterkauf

§ 7 Abs. 3 gilt nicht, wenn die von uns gelieferten, neu hergestellten Gegenstände, auch im Rahmen einer Lieferung, an Verbraucher veräußert werden.

§ 9 Schadenersatz

- 9.1. Wir haften – gleich aus welchem Rechtsgrund – nur für vorsätzliches und grob fahrlässiges Verhalten unserer Organe und Erfüllungsgehilfen sowie – ohne Rücksicht auf den Grad des Verschuldens – für Schäden aus der Verletzung des Lebens, des Körpers oder der Gesundheit.
- 9.2. Darüber hinaus haften wir auch für leichte Fahrlässigkeit unserer Organe und Erfüllungsgehilfen im Falle des Leistungsverzuges oder der Verletzung einer sonstigen Kardinalpflicht. In diesem Fall ist unsere Haftung auf solche Schäden beschränkt, mit denen wir bei Vertragsabschluss vernünftigerweise rechnen mussten.
- 9.3. Sämtliche Haftungsbeschränkungen gelten auch für den Fall, dass die Verletzung vertraglicher Pflichten zugleich eine unerlaubte Handlung darstellt.

§ 10 Eigentumsvorbehalt

- 10.1. Wir behalten uns das Eigentum an dem Liefergegenstand bis zum Eingang aller Zahlungen aus dem Liefervertrag vor. Bei vertragswidrigem Verhalten des Abnehmers, insbesondere bei Zahlungsverzug, sind wir berechtigt, nach fruchtlosem Verstreichen einer angemessenen Nachfrist den Liefergegenstand zurückzunehmen. In der Zurücknahme des Liefergegenstands durch uns liegt kein Rücktritt vom Vertrag vor, es sei denn, wir hätten dies ausdrücklich schriftlich erklärt. In der Pfändung des Liefergegenstandes durch uns liegt stets ein Rücktritt vom Vertrag vor. Wir sind nach Rücknahme des Liefergegenstandes zu dessen Verwertung befugt; der Verwertungserlös ist auf die Verbindlichkeiten des Abnehmers – abzüglich angemessener Verwertungskosten – anzurechnen.
- 10.2. Der Abnehmer ist verpflichtet, den Liefergegenstand für uns zu verwahren und pfleglich zu behandeln.
- 10.3. Bei Pfändungen oder sonstigen Eingriffen Dritter auf unsere Liefergegenstände hat uns der Abnehmer unverzüglich schriftlich zu benachrichtigen, damit wir Klage gemäß § 771 ZPO erheben können. Soweit der Dritte nicht in der Lage ist, uns die gerichtlichen und außergerichtlichen Kosten einer Klage gemäß § 771 ZPO zu erstatten, haftet der Abnehmer für den uns entstandenen Ausfall.
- 10.4. Der Abnehmer ist berechtigt, den Liefergegenstand im ordentlichen Geschäftsgang weiter zu verkaufen; er tritt uns jedoch bereits jetzt alle Forderungen in Höhe des Faktura-Endbetrages (einschließlich Mehrwertsteuer) unserer Forderung ab, die ihm aus der Weiterveräußerung gegen seine Abnehmer oder Dritte erwachsen, und zwar unabhängig davon, ob der Liefergegenstand ohne oder nach Verarbeitung weiterverkauft wird. Zur Einziehung dieser Forderung bleibt der Abnehmer auch nach der Abtretung ermächtigt. Unsere Befugnis, die Forderung selbst einzuziehen, bleibt hiervon unberührt. Wir verpflichten uns jedoch, die Forderung nicht einzuziehen, solange der Abnehmer seinen Zahlungsverpflichtungen aus den vereinbarten Erlösen nachkommt, nicht in Zahlungsverzug gerät und insbesondere kein Antrag auf Eröffnung eines Insolvenzverfahrens gestellt ist oder Zahlungseinstellung vorliegt. Ist dies jedoch der Fall, so können wir verlangen, dass der Abnehmer uns die abgetretenen Forderungen und deren Schuldner unverzüglich bekannt gibt, alle zum Einzug erforderlichen Angaben macht, die dazugehörigen Unterlagen aushändigt und dem Schuldner (Dritten) sofort die Abtretung mitteilt und uns per Kopie/Anschieben darüber informiert.
- 10.5. Die Verarbeitung oder Umbildung des Liefergegenstandes durch den Abnehmer wird stets für uns vorgenommen. Wird der Liefergegenstand mit anderen, uns nicht gehörenden Gegenständen verarbeitet, so erwerben wir das Miteigentum an der neuen Sache im Verhältnis des Werts des Liefergegenstandes (Faktura-Endbetrag einschließlich Mehrwertsteuer) zu den anderen verarbeiteten Gegenständen zum Zeitpunkt der Verarbeitung. Für die durch die Verarbeitung entstehende Sache gelten im übrigen die gleichen Bedingungen wie für den unter Vorbehalt gelieferten Gegenstand.
- 10.6. Wird der Liefergegenstand mit anderen, uns nicht gehörenden Gegenständen untrennbar vermischt, so erwerben wir das Miteigentum an der neuen Sache im Verhältnis des Werts des Liefergegenstandes (Faktura-Endbetrag einschließlich Mehrwertsteuer) zu den anderen vermischten Gegenständen zum Zeitpunkt der Vermischung. Erfolgt die Vermischung in der Weise, dass die Sache des Abnehmers als Hauptsache anzusehen ist, so gilt als vereinbart, dass der Abnehmer uns anteilmäßig Miteigentum überträgt. Der Abnehmer verwahrt das entstandene Alleineigentum oder Miteigentum für uns.
- 10.7. Wir verpflichten uns, die uns zustehenden Sicherheiten auf Verlangen des Abnehmers insoweit freizugeben, als der realisierbare Wert unserer Sicherheiten die zu sichernden Forderungen um mehr als 10% übersteigt; die Auswahl der freizugebenden Sicherheiten steht uns zu.

§ 11 Zahlungsbedingungen

- 11.1. Unsere Rechnungsbeträge sind innerhalb von 30 Tagen ohne jeden Abzug zahlbar, soweit nichts anderes vereinbart ist. Bei Ablauf dieser Frist kommt der Abnehmer in Verzug, ohne dass es einer Mahnung unsererseits bedarf.
- 11.2. Der Abnehmer ist zur Aufrechnung nur mit solchen ihm zustehenden Forderungen berechtigt, die rechtskräftig festgestellt oder unbestritten sind. Gleiches gilt für die Geltendmachung eines Zurückbehaltungsrechtes.

§ 12 Schriftform- und Schlussbestimmungen

- 12.1. Von diesen Geschäftsbedingungen abweichende Regelungen bedürfen der Schriftform. Dies gilt nicht für Regelungen, die mit Geschäftsführern oder Prokuristen unsererseits vereinbart werden.
- 12.2. Gerichtsstand für alle etwaigen Streitigkeiten aus der Geschäftsbeziehung zwischen uns und dem Abnehmer ist Gießen. Wir sind jedoch berechtigt, den Abnehmer auch an dessen allgemeinem Gerichtsstand sowie an dem Ort zu verklagen, an den der Liefergegenstand auf Wunsch des Abnehmers versandt wurde.
- 12.3. Alle Rechtsbeziehungen, die im Zusammenhang mit der Eingehung, Durchführung oder Beendigung dieses Vertrages entstehen, sind nach dem materiellen Recht der Bundesrepublik Deutschland unter Ausschluss des UN-Kaufrechts zu beurteilen. Dies gilt auch dann, wenn sie auf deliktischer oder sonstiger gesetzlicher Grundlage beruhen.

Unser Lieferprogramm:

■ MIG/MAG

- Schutzgas-Schweißbrenner
- Automaten- und Sonderbrenner
- Push-Pull-Brenner
- Rauchgas-Absaugbrenner
- Zentralstecker- und -buchsen-System

■ WIG

- Schutzgas-Schweißbrenner
- Automaten- und Sonderbrenner

■ PLASMA

- Schneidbrenner
- Schweißbrenner
- Automaten- und Sonderbrenner

■ Roboter-Peripherie

- Roboter-Brenner
MIG/WIG/Plasma
- Roboterhalterung CAT2/iCAT
- Brennerhalswechselsystem
ATS-Rotor
- Werkzeugwechselsystem WWS
- Drahtabschneidevorrichtung DAV
- Brenner-Reinigungsstationen
BRS-LC, BRS-CC und BRS-FP
- Drahtvorschubeinheit APD-MF

■ Schweißzubehör

- Wasserumlaufkühlgeräte
- Schweißkabelstecker und -buchsen
- Trennmittel, -spray und -paste
u.a.m.



ABICOR
BINZEL® 

Alexander Binzel Schweißtechnik GmbH & Co. KG
Postfach 10 01 53 · D-35331 Gießen
Tel.: ++49 (0) 64 08 / 59-0
Fax: ++49 (0) 64 08 / 59-191
E-Mail: www.binzel-abicor.com

www.binzel-abicor.com